

SPECIFICATION GUIDE & PRICE LIST

2017

PALMIER

CLASSIC

CATEGORY: LIBRARY FURNITURE
CONTRACT: BID #ESCNJ 17/18-16

Introduction	1
Table of Contents	2-5
Product Materials & Finishes	7-9
Aspen	10-25
Displays – Newspaper Table & Atlas Stand	10-11
Displays – Dictionary Stand	12-13
Displays – Display Table	14-15
Displays – AV Browser	16-17
Modular Carrels	18-19
Reference Carrels	20-21
PAC Tables	22-23
Reading Tables	24-25
Bannister	26-97
Displays – Newspaper Table	26-27
Displays – Atlas Stand	28-29
Displays – Dictionary Stand	30-31
Displays – Display Table	32-33
Study Carrel Tables	34-35
Carrels	36-47
PAC Tables	48-83
Reading Tables	84-85
Reading/Computer Tables	86-97

Element	98-119
Displays – Atlas Stand	98-99
Displays – Dictionary Stand	100-101
Modular Carrels	102-103
Reference Carrels	104-105
PAC Tables	106-111
PAC Panel Base Tables	114-117
Reading Tables	118-119
Fusion	120-141
Displays – Atlas Stand	120-121
Displays – Dictionary Stand	122-123
Displays – Display Table	124-125
Modular Carrels	126-131
Reference Carrels	132-133
PAC Tables	134-139
Reading Tables	140-141
Princeton	142-163
Displays – Newspaper Table	142-143
Displays – Atlas Stand	144-145
Displays – Dictionary Stand	146-147
Displays – Display Table	148-149
Displays – AV Browser	150-151
Index Table	152-153
Modular Carrels	154-155
PAC Tables	156-159
Reading Tables with Legs	160-161
Reading Tables with Panels	162-163

Vista	164-201	Gemini Desking System	230-245
Displays – Atlas Stand	164-165	Open Shelf & Cupboard Units, Closed Corner Units & Knee Space Unit with Cash & Pencil Drawer	230-231
Displays – Dictionary Stand	166-167	Open Corner Unit, Single Drawer Charge Unit, Single Drawer Open Shelf Unit & Book Return Unit	232-233
Displays – Display Table	168-169	Desk Units with Patron & Corner Desk Unit with Surround	234-235
Carrels	170-179	Desk Units & Corner Desk Unit	236-237
PAC Tables	180-189	Cupboard Unit Configurations	238-239
Reading Tables	190-191	Curved Desk Unit, Curved Corner Desk with Surround & ADA Unit	240-241
Reading/Computer Tables	192-201	Patron Ledges	242-243
		End & Intermediate Panels	244-245
Linx Desking System	202-229	Desk Accessories	246-251
Open Shelf & Cupboard Units	202-203	Mobile Pedestals	246-247
Closed Corner Units	204-205	Hanging Pedestals	248-249
Knee Space Unit with Cash & Pencil Drawer	206-207	Accessories	250-251
Open Corner Units	208-209		
Single Drawer Charge Units & Book Return Unit	210-211	Warranty	252
Desk Units with Surrounds	212-213	Terms & Conditions	253
Corner Desk Unit with Surround	214-215		
Desk Units	216-217		
Corner Desk Unit, 45 Degree Wedge Corner Unit & ADA Unit	218-219		
Cupboard Unit Configurations	220-221		
Curved Desk Units	222-224		
Patron Ledges	224-227		
Finished End Panels	228-229		

WOODS & FINISHES:

Natural Maple Standard

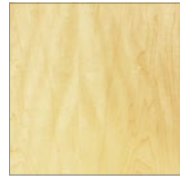

Natural Clear – M-NA

Maple Finishes

The following stains are available, add 10% to list

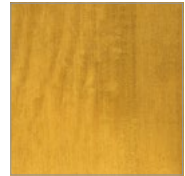

Castle Oak – M-CO

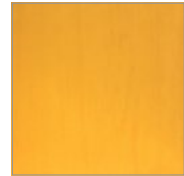

Honey Oak – M-HO

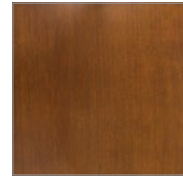

English Oak – M-EN

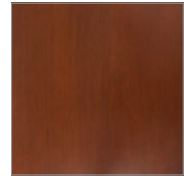

Victorian Cherry – M-VI



Richmond Cherry – M-RC



Mahogany – M-MA



Java – M-JA



Wenge – M-WE

Natural Red Oak Standard

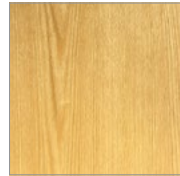

Natural Clear – O-NA

Red Oak Finishes

The following stains are available, add 10% to list

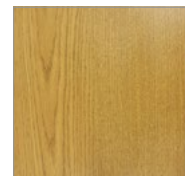

Castle Oak – O-CO

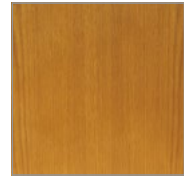

Honey Oak – O-HO

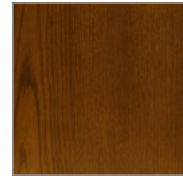

English Oak – O-EN

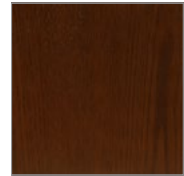

Victorian Cherry – O-VI

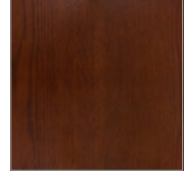

Richmond Cherry – O-RC



Mahogany – O-MA



Java – O-JA

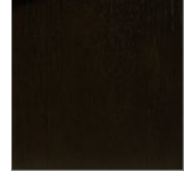

Wenge – O-WE

Natural Cherry

Add 20% to list

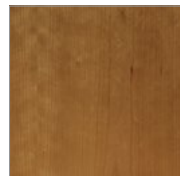

Natural Clear – C-NA

Cherry Finishes

The following stains are available, add 30% to list



Honey Oak – C-HO



Richmond Cherry – C-RC

Natural Walnut

Add 20% to list

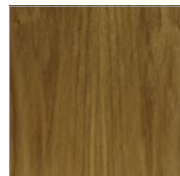

Natural Clear – W-NA

Walnut Finishes

The following stain is available, add 30% to list



Java – W-JA

WILSONART® LAMINATES:

Solid, Abstract and Wood Grain Options



Frosty White
1573-60



Black
1595-60



Island
D498-60

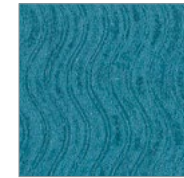

Blue Agave
4919-60



Mambo
7948-60

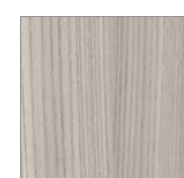

Grey Elm
8201-38



Natural Almond
D30-60



Indigo
D379-60



Hunter Green
D79-60



Eggplant
4913-60



Cocobala
7942-38

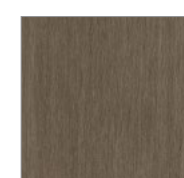

Phantom Cocoa
8213-38

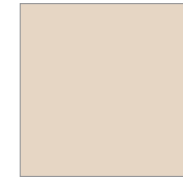

Beige
1530-60

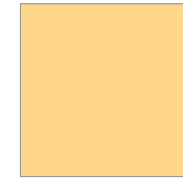

Sunshine
D499-60



Ocean
D502-60



Spiced Zephyr
4859-60



Walnut Heights
7965-38



Studio Teak
7960-38



Fashion Grey
D381-60



Orange Grove
D501-60



Lapis Blue
D417-60



Morro Zephyr
4846-60



Wild Cherry
7054-60

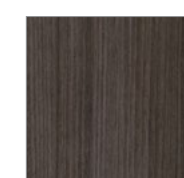

Skyline Walnut
7964-38

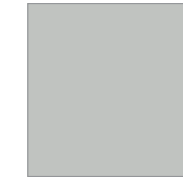

Dove Grey
D92-60



Hollyberry
D307-60

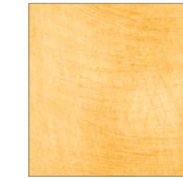

Maroochy Brush
4745-60



Fusion Maple
7909-60



Phantom Pearl
8211-38



Phantom Charcoal
8214-38



Slate Grey
D91-60



Port
D14-60



Woolamai Brush
4746-60

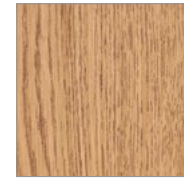

Bannister Oak
7806-60



White Driftwood
8200-38



Asian Night
7949-38

METAL PAINT:

Thermal Paint Colours



White
PS-111-W374



Antique White
W11



Beige
H23

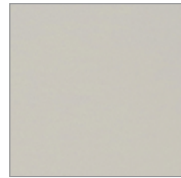

Desert
H432



Red
R66



Ruby
R7



Blue
B11



Navy
B17



Zinc
A67



Hydro Green
G96



Green
G58

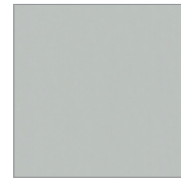

Grey
A16

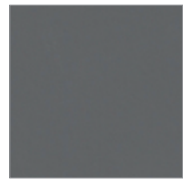

Charcoal
A230



Black
N49



Pebble
M237

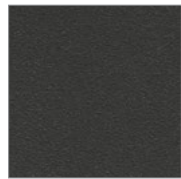

Black Sandtex
N31



Sparkling Silver
S11



Champagne
S14

EDGE BAND COLOURS:

PVC edge band colour options

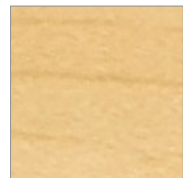

Hardrock Maple
AC-WM791

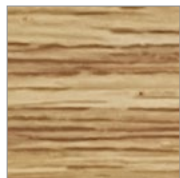

Natural Oak
AC-FWG9877



Chocolate Tick
AC-FWG7424

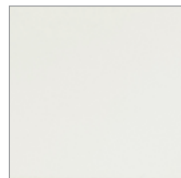

White
AC-SW811



Antique White
AC-W11



Beige
AC-H23

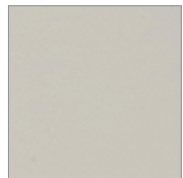

Desert
AC-H432



Red
AC-R66



Ruby
AC-R7



Blue
AC-B11



Navy
AC-B17

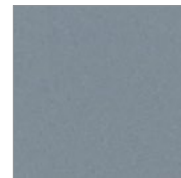

Zinc
AC-A67

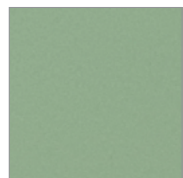

Hydro Green
AC-G96



Green
AC-G58

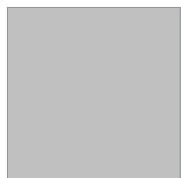

Grey
AC-A16

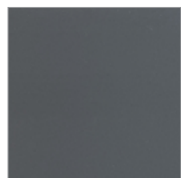

Charcoal
AC-A230



Black
AC-N49



Pebble
AC-M237

HARDWOODS: All hardwood materials used in the manufacturing of Palmieri products shall be Northern grown hardwoods. Hardwoods will be air and kiln dried to a moisture content of 5-7%. All hardwoods shall be of grade "A" material, free of material stains, imperfections, conformity of grain, texture and color. Hardwood species shall be Northern grown Red Oak, Clear White Northern Maple and Birch. American Cherry and Honduras Mahogany and Walnut are available. Please inquire for pricing.

VENEER: Exposed face veneers shall be not less than 1/28" thick plain sliced veneers. Veneers are to be selected for conformity of grain direction and color. Veneers are to be stitched tightly in a book match, slip match or plain sliced configuration. Unexposed veneers are to be of hardwood but not selected for color, or grain quality. Veneers are not to be lap joined or reveal any tape or glue lines.

PARTICLE BOARD CORE: The particleboard shall be formed of wood chips, bonded with a water resistance adhesive. The particleboard material is to be of a high density 45 lbs/cu. ft. having a minimum average modulus of rupture of 2400 psi and a minimum average modulus of elasticity of 4,000,000 psi.

VENEER CORE: Veneer core is to be constructed with odd numbers of plies. Each ply is to be laminated in pairs and cross banded in opposite directions with grain direction at a 90 degree angle to the grain of the center core. All plies are to be free from knots, wrinkles, laps or other natural or manufacturing defects.

LUMBER CORE: Lumber core is to be of the highest quality grade. Grade "A" select stock. Lumber core shall be constructed of solid random width strips not less than 2" wide nor more than 3 1/2" wide by 1" thick. Wood strips will be free from knots or other defects. All strips will be tightly joined using water resistance adhesives.



HIGH PRESSURE LAMINATE: Work surface laminate shall be .050" thick and used with balancing backer sheet of no less than .028" thick. Laminate shall conform to standards set by the American Standards Institute/National Electrical Manufacturers Association (ANSI/NEMA) for thickness, performance and appearance. Printed colours, abstract patterns and wood grains are reproduced from representative segments of large sheets and may differ slightly from the actual product.

FINISHING PROCEDURES: All materials shall be inspected and treated with a final sanding and polishing operation before any staining and final finishing can be performed. All machine and mill marks are to be removed. Once the polishing and sanding has been performed, the furniture will then undergo the following stain and finishing procedures:

- Step 1 A base stain will be uniformly applied, wiped and then allowed to dry under factory controlled conditions.
- Step 2 A uniform coat of sealer will be applied and allowed to dry.
- Step 3 Sealer will be lightly sanded using 240 grit silicon paper.
- Step 4 A catalytic lacquer of 34-45 degree sheen is evenly applied and allowed to dry under factory controlled conditions.

METAL FINISHING PROCEDURES: All metal components are thoroughly cleaned and coated electrostatically with an epoxy powder coat paint finish. The metal components are then oven baked and cured for a lasting finish.

EDGE BANDS: All edge bands are manufactured in PVC, semi-rigid (Flex) and ABS. Standard edging size are normally 1.25" wide x 3 mm thick. These are made of the highest grade polymers and its materials are extensively tested prior to production using special test procedures and industry specification and quality standards.

	MODEL NUMBER	PRODUCT	W	D	H	WEIGHT	VOLUME	LIST PRICE	DESCRIPTION
	AP-NP	Newspaper Table	39 1/2"	27"	30"	180 Lbs.	21 Cu Ft	\$ 3,388	<p>TABLE RACK: Open frame construction consists of 7/8" thick x 3" wide solid hardwood, all edges eased with newspaper stick holders fitted on either side of rack to accommodate 10 wood newspaper sticks.</p> <p>END PANELS: Panel frame construction consists of a 1 1/16" thick 3-ply particleboard core with plain sliced veneer both faces, 1 3/4" thick x 2 1/2" wide solid hardwood framed on four sides and three inset 1/2" thick x 1 3/4" wide solid vertical pilasters. All edges of panel frame and pilasters are eased.</p>
	AP-AS	Atlas Stand	30 1/2"	29"	44 1/2"	260 Lbs.	30 Cu Ft	\$ 5,050	<p>TOP: Sloped top is constructed of 3/4" particleboard core with plastic laminate surfaces and fitted with a wood book rail 5/8" thick x 5/8" wide.</p> <p>CONSTRUCTION ASSEMBLY: Cabinet construction consists of a 3/4" thick 3-ply particleboard core back with plain sliced veneer both faces, five 3/4" thick 3-ply particleboard core pull-out shelves with 3/4" thick x 1 3/4" high solid wood retainer lip operating on bottom mounted single extension drawer runners.</p> <p>END PANELS: Panel frame construction consists of a 1 1/16" thick 3-ply particleboard core with plain sliced veneer both faces, 1 3/4" thick x 2 1/2" wide solid hardwood framed on four sides and three inset 1/2" thick x 1 3/4" wide solid vertical pilasters. All edges of panel frame and pilasters are eased.</p>



MODEL NUMBER	PRODUCT	W	D	H	WEIGHT	VOLUME	LIST PRICE	DESCRIPTION
AP-DC	Dictionary Stand	27 ¹ / ₂ "	21	44 ¹ / ₂ "	180 Lbs.	20 Cu Ft	\$ 3,756	<p>TOP: Sloped top is constructed of ³/₄" particleboard core with plastic laminate surfaces and fitted with a wood book rail ⁵/₈" thick x ⁵/₈" wide.</p> <p>CONSTRUCTION ASSEMBLY: Cabinet construction consists of a ³/₄" thick 3-ply particleboard core back with plain sliced veneer both faces, a ³/₄" thick 3-ply particleboard core adjustable shelf and a ³/₄" thick 3-ply particleboard core fixed bottom shelf with ³/₄" thick x 1³/₄" high solid wood drop edge.</p> <p>END PANELS: Panel frame construction consists of a 1¹/₁₆" thick 3-ply particleboard core with plain sliced veneer both faces, 1³/₄" thick x 2¹/₂" wide solid hardwood framed on four sides and three inset ¹/₂" thick x 1³/₄" wide solid vertical pilasters. All edges of panel frame and pilasters are eased.</p>



MODEL NUMBER	PRODUCT	W	D	H	WEIGHT	VOLUME	LIST PRICE	DESCRIPTION
AP-DP	Display Table	66"	30 1/2"	39"	245 Lbs.	23 Cu Ft	\$ 8,338	<p>DISPLAY CASE CONSTRUCTION: Wood frame is constructed of 1 1/2" thick x 1 1/2" wide solid hardwood with 1/4" thick glass on all 4 sides and top with all edges eased. One long back side of the case is equipped with sliding glass doors complete with lock. Display case size: 30" deep x 62" wide x 10" high.</p> <p>TOP: Tops are constructed of 1 1/4" thick 3-ply particleboard core. Tops surface is laminated with a .050" thick high pressure plastic laminate sheet and bottom surface laminated with a backing sheet not less than .020" thick for balanced construction. Work surface edge is 3/4" thick x 1 5/8" solid hardwood at two long edges.</p> <p>END PANELS: Panel frame construction consists of a 1 1/16" thick 3-ply particleboard core with plain sliced veneer both faces, 1 3/4" thick x 2 1/2" wide solid hardwood framed on four sides and three inset 1/2" thick x 1 3/4" wide solid vertical pilasters. All edges of panel frame and pilasters are eased.</p>
AP-DP-FB	Display Table with Fabric Covered Bottom	66"	30 1/2"	39"	245 Lbs.	23 Cu Ft	\$ 9,169	

MODEL NUMBER	PRODUCT	W	D	H	WEIGHT	VOLUME	LIST PRICE	DESCRIPTION
--------------	---------	---	---	---	--------	--------	------------	-------------

AP-AV

AV Browser

50¹/₄"

23

42¹/₂"

260 Lbs.



36 Cu Ft



\$ 3,875



MULTIMEDIA DISPLAY BIN:
Bin construction consisting of ³/₄" thick 3-ply particleboard core with plain sliced veneer both faces and seven equally divided compartments, each 6¹/₄" wide x 19" deep with six removable ¹/₄" side dividers and will hold approximately 290 compact discs.



END PANELS:
Panel frame construction consists of a 1¹/₁₆" thick 3-ply particleboard core with plain sliced veneer both faces, 1³/₄" thick x 2¹/₂" wide solid hardwood framed on four sides and three inset ¹/₂" thick x 1³/₄" wide solid vertical pilasters. All edges of panel frame and pilasters are eased.



	MODEL NUMBER	PRODUCT	W	D	H	WEIGHT	VOLUME	LIST PRICE	DESCRIPTION
	AP-MC-36-SS	Single Face Modular Carrels: 36" Starter	38 1/2"	31"	48"	340 Lbs.	11 Cu Ft	\$ 4,131	<p>WORK SURFACE: Tops are constructed of 1 1/4" thick 3-ply particleboard core. Tops surface is laminated with a .050" thick high pressure plastic laminate sheet and bottom surface laminated with a backing sheet not less than .020" thick for balanced construction. Front work surface edge is 3/4" thick x 1 5/8" high solid hardwood with edges eased. Work surface is 28" deep x 29" high.</p> <p>END PANELS: Panel frame construction consists of a 1 1/16" thick 3-ply particleboard core with plain sliced veneer both faces, 1 3/4" thick x 2 1/2" wide solid hardwood framed on four sides and three inset 1/2" thick x 1 3/4" wide solid vertical pilasters. All edges of panel frame and pilasters are eased. Single face and pinwheel shall receive three vertical pilasters and double face shall receive five vertical pilasters.</p> <p>INTERMEDIATE PANELS: Panels are constructed of 1 3/16" thick 3-ply particleboard core with plain sliced veneer both faces, 1 3/16" thick x 2 1/2" wide solid hardwood framed on four sides with all edges eased.</p> <p>BACK PANEL: Back is constructed of 1 1/16" thick 3-ply particleboard core with plain sliced veneer both faces and the top edge is banded with a 1 1/16" thick x 2 1/4" wide solid hardwood.</p> <p>TOP SHELF: Shelf construction consists of 3/4" thick 3-ply particleboard core with plain sliced veneer both faces and the front edge is banded with a 1/4" solid external edge complete with a 3/4" thick x 1 1/2" wide solid hardwood valance rail mounted to the underside. Shelf is 10" deep positioned 15 1/2" above the work surface.</p>
	AP-MC-36-SA	36" Adder	36 1/4"	31"	48"	160 Lbs.	11 Cu Ft	\$ 2,719	
	AP-MC-48-SS	48" Starter	50 1/2"	31"	48"	360 Lbs.	11 Cu Ft	\$ 4,256	
	AP-MC-48-SA	48" Adder	48 1/4"	31"	48"	190 Lbs.	11 Cu Ft	\$ 2,844	
	AP-MC-36-DS	Double Face Modular Carrels: 36" Starter	38 1/2"	60 1/2"	48"	655 Lbs.	22 Cu Ft	\$ 5,769	
	AP-MC-36-DA	36" Adder	36 1/4"	60 1/2"	48"	250 Lbs.	22 Cu Ft	\$ 3,663	
	AP-MC-48-DS	48" Starter	50 1/2"	60 1/2"	48"	710 Lbs.	22 Cu Ft	\$ 5,944	
	AP-MC-48-DA	48" Adder	48 1/4"	60 1/2"	48"	310 Lbs.	22 Cu Ft	\$ 3,844	
	AP-MC-36-PW	36" Pinwheel	74 1/2"	74 1/2"	48"	780 Lbs.	48 Cu Ft	\$ 9,538	
	AP-MC-48-PW	48" Pinwheel	91 1/2"	91 1/2"	48"	800 Lbs.	55 Cu Ft	\$ 9,875	

MODEL NUMBER	PRODUCT	W	D	H	WEIGHT	VOLUME	LIST PRICE	DESCRIPTION	
	Single Face Reference Carrels:								
	AP-RC-36-SS	36" Starter	38 ¹ / ₂ "	31"	48"	340 Lbs.	11 Cu Ft	\$ 4,225	<p>WORK SURFACE: Tops are constructed of 1¹/₄" thick 3-ply particleboard core. Tops surface is laminated with a .050" thick high pressure plastic laminate sheet and bottom surface laminated with a backing sheet not less than .020" thick for balanced construction. Front work surface edge is 3³/₄" thick x 1⁵/₈" high solid hardwood with edges eased. Tops will be set back from the back panel 2" to provide a wire drop and will be fitted with a retainer lip. Work surface is 26" deep and is adjustable at four increments 39", 32", 29" and 27" high.</p> <p>END PANELS: Panel frame construction consists of a 1¹/₁₆" thick 3-ply particleboard core with plain sliced veneer both faces, 1³/₄" thick x 2¹/₂" wide solid hardwood framed on four sides and three inset 1¹/₂" thick x 1³/₄" wide solid vertical pilasters. All edges of panel frame and pilasters are eased. Single face and pinwheel shall receive three vertical pilasters and double face shall receive five vertical pilasters.</p> <p>INTERMEDIATE PANELS: Panels are constructed of 1³/₁₆" thick 3-ply particleboard core with plain sliced veneer both faces, 1³/₁₆" thick x 2¹/₂" wide solid hardwood framed on four sides with all edges eased.</p> <p>BACK PANEL: Back is constructed of 1¹/₁₆" thick 3-ply particleboard core with plain sliced veneer both faces and the top edge is banded with a 1¹/₁₆" thick x 2¹/₄" wide solid hardwood.</p> <p>BOTTOM SHELF: Shelf construction consists of 3³/₄" thick 3-ply particleboard core with plain sliced veneer both faces and the front edge is banded with a 1¹/₄" solid external edge complete with a 3³/₄" thick x 1¹/₂" wide solid hardwood valance rail mounted to the underside. Shelf is 10" deep positioned 21" above the floor.</p>
	AP-RC-36-SA	36" Adder	36 ¹ / ₄ "	31"	48"	160 Lbs.	11 Cu Ft	\$ 2,713	
	AP-RC-48-SS	48" Starter	50 ¹ / ₂ "	31"	48"	360 Lbs.	11 Cu Ft	\$ 4,350	
AP-RC-48-SA	48" Adder	48 ¹ / ₄ "	31"	48"	190 Lbs.	11 Cu Ft	\$ 2,831		
	Double Face Reference Carrels:								
	AP-RC-36-DS	36" Starter	38 ¹ / ₂ "	60 ¹ / ₂ "	48"	655 Lbs.	22 Cu Ft	\$ 5,756	
	AP-RC-36-DA	36" Adder	36 ¹ / ₄ "	60 ¹ / ₂ "	48"	250 Lbs.	22 Cu Ft	\$ 3,644	
	AP-RC-48-DS	48" Starter	50 ¹ / ₂ "	60 ¹ / ₂ "	48"	710 Lbs.	22 Cu Ft	\$ 5,925	
AP-RC-48-DA	48" Adder	48 ¹ / ₄ "	60 ¹ / ₂ "	48"	310 Lbs.	22 Cu Ft	\$ 3,825		
	AP-RC-36-PW	36" Pinwheel	74 ¹ / ₂ "	74 ¹ / ₂ "	48"	780 Lbs.	48 Cu Ft	\$ 9,513	
	AP-RC-48-PW	48" Pinwheel	91 ¹ / ₂ "	91 ¹ / ₂ "	48"	800 Lbs.	55 Cu Ft	\$ 9,638	

	MODEL NUMBER	PRODUCT	W	D	H	WEIGHT	VOLUME	LIST PRICE	DESCRIPTION
	AP-PAC-1-PB-29	1 Person PAC Table: Sitting Height	37 ¹ / ₂ "	36"	37"	130 Lbs.	13 Cu Ft	\$ 3,794	<p>WORK SURFACE: Tops are constructed of 1¹/₄" thick 3-ply particleboard core. Tops surface is laminated with a .050" thick high pressure plastic laminate sheet and bottom surface laminated with a backing sheet not less than .020" thick for balanced construction. Work surface edge is 3³/₄" thick x 1⁵/₈" solid hardwood at two long edges.</p> <p>DIVIDER RACK: Divider rack construction consists of 3³/₄" thick x 7" deep x 8" high solid hardwood side dividers and 3³/₄" thick 3-ply particleboard core back dividers with plain sliced veneer both faces and the top edge is banded with a 1¹/₄" solid external edge.</p> <p>END PANELS: Panel frame construction consists of a 1¹/₁₆" thick 3-ply particleboard core with plain sliced veneer both faces, 1³/₄" thick x 2¹/₂" wide solid hardwood framed on four sides and three inset 1¹/₂" thick x 1³/₄" wide solid vertical pilasters. All edges of panel frame and pilasters are eased.</p> <p>ELECTRICAL ACCESSORIES: Each seating position will be equipped with a 3" diameter black plastic grommet and a black painted metal back mount j-channel wire manager.</p>
	AP-PAC-1-PB-32	Wheelchair Accessible	37 ¹ / ₂ "	36"	40"	130 Lbs.	16 Cu Ft	\$ 3,900	
	AP-PAC-1-PB-39	Standing Height	37 ¹ / ₂ "	36"	47"	135 Lbs.	23 Cu Ft	\$ 4,125	
	AP-PAC-2-PB-29	2 Person PAC Table: Sitting Height	73 ¹ / ₂ "	36"	37"	200 Lbs.	27 Cu Ft	\$ 4,450	
	AP-PAC-2-PB-32	Wheelchair Accessible	73 ¹ / ₂ "	36"	40"	200 Lbs.	33 Cu Ft	\$ 4,563	
	AP-PAC-2-PB-39	Standing Height	73 ¹ / ₂ "	36"	47"	205 Lbs.	46 Cu Ft	\$ 4,763	
	AP-PAC-3-PB-29	3 Person PAC Table: Sitting Height	91 ¹ / ₂ "	36"	37"	250 Lbs.	34 Cu Ft	\$ 4,894	
	AP-PAC-3-PB-32	Wheelchair Accessible	91 ¹ / ₂ "	36"	40"	250 Lbs.	41 Cu Ft	\$ 4,994	
	AP-PAC-3-PB-39	Standing Height	91 ¹ / ₂ "	36"	47"	260 Lbs.	58 Cu Ft	\$ 5,206	

	MODEL NUMBER	PRODUCT	W	D	H	WEIGHT	VOLUME	LIST PRICE	DESCRIPTION
	AP-R42	Round Table	42"	42"	29"	90 Lbs.	8 Cu Ft	\$ 2,263	<p>WORK SURFACE: Tops are constructed of 1 1/4" thick 3-ply particleboard core. Tops surface is laminated with a .050" thick high pressure plastic laminate sheet and bottom surface laminated with a backing sheet not less than .020" thick for balanced construction. Two long edges of the rectangular tables will be banded with a 1/4" wide x 1 1/4" thick solid hardwood external edge and the two ends will be banded with 2 5/8" wide x 1 1/4" thick solid hardwood external edge. Circular tables will be banded with a 1/4" wide x 1 1/4" thick solid hardwood external edge. Square tables will be banded on all 4 sides with 2 5/8" wide x 1 1/4" thick solid hardwood external edges. All edges are eased.</p> <p>END FRAME: End frame construction consists of two 2 3/8" x 2 3/8" glued-up solid stock legs, two 1 1/4" thick x 2 1/2" wide solid hardwood horizontal rail members and five 3/4" thick x 1 7/8" wide solid vertical pilasters. All edges of end frame and pilasters are eased.</p> <p>APRON: Apron rail is constructed of 1 1/4" thick x 2 1/2" wide solid hardwood and fitted between the legs on either side of the end frame assembly. Apron rails for circular and square tables are 3/4" thick x 3 3/8" wide solid hardwood and mechanically fasted between legs.</p> <p>WORK SURFACE HEIGHT: Table heights of 25" (children), 27" (youth), and 32" (wheelchair) are available by request.</p>
	AP-R48		48"	48"	29"	100 Lbs.	10 Cu Ft	\$ 2,375	
	AP-4242	Square Table	42"	42"	29"	90 Lbs.	8 Cu Ft	\$ 2,869	
	AP-4848		48"	48"	29"	100 Lbs.	10 Cu Ft	\$ 3,063	
	AP-6036	60" Wide Rectangular Table	60"	36"	29"			\$ 3,794	
	AP-6048		60"	48"	29"			\$ 4,069	
	AP-7236	72" Wide Rectangular Table	72"	36"	29"			\$ 3,969	
	AP-7248		72"	48"	29"			\$ 4,256	
	AP-8436	84" Wide Rectangular Table	84"	36"	29"			\$ 4,138	
	AP-8448		84"	48"	29"			\$ 4,444	
AP-9636	96" Wide Rectangular Table	96"	36"	29"			\$ 4,319		
AP-9648		96"	48"	29"			\$ 4,625		

	MODEL NUMBER	PRODUCT	W	D	H	WEIGHT	VOLUME	LIST PRICE	DESCRIPTION
	BA-NP	Newspaper Table	39"	27"	30"	180 Lbs.	30 Cu Ft	\$ 3,869	<p>TABLE RACK: Open frame construction consists of 7/8" thick x 3" wide solid hardwood, all edges eased with newspaper stick holders fitted on either side of rack to accommodate 10 wood newspaper sticks.</p> <p>APRON RAIL: Two 3/4" thick x 2" high solid hardwood rail shall be fitted between the panels on either side.</p> <p>END PANELS: Panel frame construction consists of a 1 1/16" thick 3-ply particleboard core with plain sliced veneer both faces, two 1 1/2" thick x 2 5/8" wide solid hardwood sides, 1 1/2" thick x 3 1/2" top member and a 1 1/2" thick x 5" wide bottom with a 2 1/2" arched center. Center frame will be fitted with one horizontal and two vertical 1/2" thick x 2" wide stile members, creating a rectangle and square motif design. All spaces are then miter framed with 7/16" thick x 3/4" wide angled solid hardwood trim creating a raised frame effect. All edges of panel frame and trim are eased.</p> <p>NOTE: List price shown is available for any of the 6 Bannister panel frame versions.</p>





























MODEL NUMBER	PRODUCT	W	D	H	WEIGHT	VOLUME	LIST PRICE	DESCRIPTION
BA-AS	Atlas Stand	30"	29"	45"	260 Lbs.	32 Cu Ft	\$ 5,363	<p>TOP: Sloped top is constructed from 1 1/4" thick 3-ply particleboard core. Slope top surface is laminated with a .050" thick high pressure plastic laminate sheet and bottom surface laminated with a backing sheet not less than .020" thick for balanced construction. Front edge banded with a 3/4" thick x 1 3/4" high book support lip.</p> <p>CONSTRUCTION ASSEMBLY Cabinet construction consists of a 3/4" thick 3-ply particleboard core back with plain sliced veneer both faces, five 3/4" thick 3-ply particleboard core pull-out shelves with 3/4" thick x 1-3/4" high solid wood retainer lip operating on bottom mounted single extension drawer runners.</p> <p>END PANELS: Panel frame construction consists of a 1 1/16" thick 3-ply particleboard core with plain sliced veneer both faces, two 1 1/2" thick x 2 5/8" wide solid hardwood sides, 1 1/2" thick x 2" arched top member and a 1 1/2" thick x 4 1/2" wide bottom with an arched end. Center frame will be fitted with three horizontal and two vertical 1/2" thick x 2" wide stile members, creating a rectangle and square motif design. All spaces are then miter framed with 7/16" thick x 3/4" wide angled solid hardwood trim creating a raised frame effect. All edges of panel frame and trim are eased.</p> <p>NOTE: List price shown is available for any of the 6 Bannister panel frame versions.</p>



MODEL NUMBER	PRODUCT	W	D	H	WEIGHT	VOLUME	LIST PRICE	DESCRIPTION
BA-DC	Dictionary Stand	27"	22"	45"	180 Lbs.	15 Cu Ft	\$ 3,825	<p>TOP: Sloped top is constructed from 1 1/4" thick 3-ply particleboard core. Slope top surface is laminated with a .050" thick high pressure plastic laminate sheet and bottom surface laminated with a backing sheet not less than .020" thick for balanced construction. Front edge banded with a 3/4" thick x 1 3/4" high book support lip.</p> <p>CONSTRUCTION ASSEMBLY Cabinet construction consists of a 3/4" thick 3-ply particleboard core back with plain sliced veneer both faces, five 3/4" thick 3-ply particleboard core pull-out shelves with 3/4" thick x 1-3/4" high solid wood retainer lip operating on bottom mounted single extension drawer runners.</p> <p>END PANELS: Panel frame construction consists of a 1 1/16" thick 3-ply particleboard core with plain sliced veneer both faces, two 1 1/2" thick x 2 5/8" wide solid hardwood sides, 1 1/2" thick x 2" arched top member and a 1 1/2" thick x 4 1/2" wide bottom with an arched end. Center frame will be fitted with three horizontal and two vertical 1/2" thick x 2" wide stile members, creating a rectangle and square motif design. All spaces are then miter framed with 7/16" thick x 3/4" wide angled solid hardwood trim creating a raised frame effect. All edges of panel frame and trim are eased.</p> <p>NOTE: List price shown is available for any of the 6 Bannister panel frame versions.</p>

	MODEL NUMBER	PRODUCT	W	D	H	WEIGHT	VOLUME	LIST PRICE	DESCRIPTION
	BA-DP	Display Table	66 1/2"	34 1/2"	39"	245 Lbs.	20 Cu Ft	\$ 10,313	<p>DISPLAY CASE CONSTRUCTION: Wood frame is constructed of 1 1/2" thick x 1 1/2" wide solid hardwood with 1/4" thick glass on all 4 sides and top with all edges eased. One long back side of the case is equipped with sliding glass doors complete with lock. Display case size: 30" deep x 62" wide x 10" high.</p> <p>WORK SURFACE: Tops are constructed of 1 1/4" thick 3-ply particleboard core. Top surface is laminated with a .050" thick high pressure plastic laminate sheet and bottom surface laminated with a backing sheet not less than .020" thick for balanced construction. Surrounding edges will be 1 1/4" thick x 2 1/4" wide solid external hardwood knife profile with 1/2" rounded point and shall be mitered and radiused at corners.</p> <p>END PANELS: Panel frame construction consists of a 1 1/16" thick 3-ply particleboard core with plain sliced veneer both faces, two 1 1/2" thick x 2 5/8" wide solid hardwood sides, 1 1/2" thick x 3 1/2" top member and a 1 1/2" thick x 5" wide bottom with a 2 1/2" arched center. Center frame will be fitted with one horizontal and two vertical 1/2" thick x 2" wide stile members, creating a rectangle and square motif design. All spaces are then miter framed with 7/16" thick x 3/4" wide angled solid hardwood trim creating a raised frame effect. All edges of panel frame and trim are eased.</p> <p>NOTE: List price shown is available for any of the 6 Bannister panel frame versions.</p>
	BA-BP-FB	Display Table with Fabric Bottom	66 1/2"	34 1/2"	39"	170 Lbs.	20 Cu Ft	\$ 11,144	

	MODEL NUMBER	PRODUCT	W	D	H	WEIGHT	VOLUME	LIST PRICE	DESCRIPTION
	BA-SC-S	1 Person Study Carrel Table	36"	24"	47"			\$ 6,494	<p>WORK SURFACE: Tops are constructed of 1 1/4" thick 3-ply particleboard core. Top surface is laminated with a .050" thick high pressure plastic laminate sheet and bottom surface laminated with a backing sheet not less than .020" thick for balanced construction. Surrounding edges will be 1 1/4" thick x 2 1/4" wide solid external hardwood knife profile with 1/2" rounded point and shall be mitered and radiused at corners.</p> <p>SUPERSTRUCTURE: 18" high Side panels, mid panel, back panels and shelves constructed from 3/4" veneer plywood. Top and front edge of rack and shelves are banded with 1/4" solid hardwood, all edges eased. Fixed shelf 8 3/4" deep shall be fitted 14 1/4" clear above table.</p> <p>END PANELS: Panel frame construction consists of a 1 1/16" thick 3-ply particleboard core with plain sliced veneer both faces, two 1 1/2" thick x 2 5/8" wide solid hardwood sides, 1 1/2" thick x 3 1/2" top member and a 1 1/2" thick x 5" wide bottom with a 2 1/2" arched center. Center frame will be fitted with one horizontal and two vertical 1/2" thick x 2" wide stile members, creating a rectangle and square motif design. All spaces are then miter framed with 7/16" thick x 3/4" wide angled solid hardwood trim creating a raised frame effect. All edges of panel frame and trim are eased.</p> <p>NOTE: List price shown is available for any of the 6 Bannister panel frame versions.</p>
	BA-SC-D	2 Person Study Carrel Table	36"	48"	47"			\$ 8,869	
	BA-SC-O	4 Person Study Carrel Table	69 1/2"	48"	47"			\$ 11,644	

MODEL NUMBER	PRODUCT	W	D	H	WEIGHT	VOLUME	LIST PRICE
	Single Face Carrel Version 1: Acrylic Style: 36" Starter	38"	30 ³ / ₄ "	48"	200 Lbs.	10 Cu Ft	\$ 5,719
	36" Adder	36 ¹ / ₂ "	30 ³ / ₄ "	48"	150 Lbs.	7 Cu Ft	\$ 4,050
	48" Starter	50"	30 ³ / ₄ "	48"	230 Lbs.	11 Cu Ft	\$ 5,863
	48" Adder	48 ¹ / ₂ "	30 ³ / ₄ "	48"	180 Lbs.	8 Cu Ft	\$ 4,194
	Double Face Carrel Version 1: Acrylic Style: 36" Starter	38"	60"	48"	350 Lbs.	14 Cu Ft	\$ 8,694
	36" Adder	36 ¹ / ₂ "	60"	48"	240 Lbs.	11 Cu Ft	\$ 5,694
	48" Starter	50"	60"	48"	410 Lbs.	16 Cu Ft	\$ 8,919
	48" Adder	48 ¹ / ₂ "	60"	48"	310 Lbs.	12 Cu Ft	\$ 5,919
	Single Face Carrel Version 1: Molding Style: 36" Starter	38"	30 ³ / ₄ "	48"	200 Lbs.	10 Cu Ft	\$ 6,044
	36" Adder	36 ¹ / ₂ "	30 ³ / ₄ "	48"	150 Lbs.	7 Cu Ft	\$ 4,050
	48" Starter	50"	30 ³ / ₄ "	48"	230 Lbs.	11 Cu Ft	\$ 6,188
	48" Adder	48 ¹ / ₂ "	30 ³ / ₄ "	48"	180 Lbs.	8 Cu Ft	\$ 4,194
	Double Face Carrel Version 1: Molding Style: 36" Starter	38"	60"	48"	350 Lbs.	14 Cu Ft	\$ 9,431
	36" Adder	36 ¹ / ₂ "	60"	48"	240 Lbs.	11 Cu Ft	\$ 5,694
	48" Starter	50"	60"	48"	410 Lbs.	16 Cu Ft	\$ 9,663
	48" Adder	48 ¹ / ₂ "	60"	48"	310 Lbs.	12 Cu Ft	\$ 5,919
	Single Face Carrel Version 1: Shaker Style: 36" Starter	38"	30 ³ / ₄ "	48"	200 Lbs.	10 Cu Ft	\$ 5,544
	36" Adder	36 ¹ / ₂ "	30 ³ / ₄ "	48"	150 Lbs.	7 Cu Ft	\$ 4,050
	48" Starter	50"	30 ³ / ₄ "	48"	230 Lbs.	11 Cu Ft	\$ 5,688
	48" Adder	48 ¹ / ₂ "	30 ³ / ₄ "	48"	180 Lbs.	8 Cu Ft	\$ 4,194
	Double Face Carrel Version 1: Shaker Style: 36" Starter	38"	60"	48"	350 Lbs.	14 Cu Ft	\$ 8,338
	36" Adder	36 ¹ / ₂ "	60"	48"	240 Lbs.	11 Cu Ft	\$ 5,694
	48" Starter	50"	60"	48"	410 Lbs.	16 Cu Ft	\$ 8,569
	48" Adder	48 ¹ / ₂ "	60"	48"	310 Lbs.	12 Cu Ft	\$ 5,919













WORK SURFACE:
Tops are constructed of 1¹/₄" thick 3-ply particleboard core. Top surface is laminated with a .050" thick high pressure plastic laminate sheet and bottom surface laminated with a backing sheet not less than .020" thick for balanced construction. Front edge shall receive a 1¹/₄" thick x 2¹/₄" wide solid external hardwood knife profile with 1¹/₂" rounded point. Work surface is 28" deep x 29" high.

END PANELS:
Version 1 - Acrylic Style: Panel frame construction consists of two 1¹/₂" x 2⁵/₈" wide solid hardwood sides, 1¹/₂" thick x 2" arched top member and a 1¹/₂" thick x 4¹/₂" wide bottom with an arched end. Center frame will be fitted with two horizontal and two vertical 1¹/₂" thick x 2" wide stile members, creating a rectangle and square motif design. All spaces are then fitted with 3³/₈" thick frosted acrylic inserts. All edges of panel frame are eased.

Version 1 - Molding Style: Panel frame construction consists of a 1¹/₁₆" thick 3-ply particleboard core with plain sliced veneer both faces, two 1¹/₂" thick x 2⁵/₈" wide solid hardwood sides, 1¹/₂" thick x 2" arched top member and a 1¹/₂" thick x 4¹/₂" wide bottom with an arched end. Center frame will be fitted with two horizontal and two vertical 1¹/₂" thick x 2" wide stile members, creating a rectangle and square motif design. All spaces are then miter framed with 7⁷/₁₆" thick x 3³/₄" wide angled solid hardwood trim creating a raised frame effect. All edges of panel frame and trim are eased.

Version 1 - Shaker Style: Panel frame construction consists of a 1¹/₁₆" thick 3-ply particleboard core with plain sliced veneer both faces, two 1¹/₂" thick x 2⁵/₈" wide solid hardwood sides, 1¹/₂" thick x 2" arched top member and a 1¹/₂" thick x 4¹/₂" wide bottom with an arched end. Center frame will be fitted with two horizontal and two vertical 1¹/₂" thick x 2" wide stile members, creating a rectangle and square motif design. All edges of panel frame are eased.

BACK PANEL:
Back is constructed of 1¹/₁₆" thick 3-ply particleboard core with plain sliced veneer both faces and the top edge is banded with a 1¹/₁₆" thick x 2¹/₄" wide solid hardwood.

MODEL NUMBER	PRODUCT	W	D	H	WEIGHT	VOLUME	LIST PRICE
		Single Face Carrel Version 2: Acrylic Style:					
BA-MC-V2A-36-SS	36" Starter	38"	30 ³ / ₄ "	48"	200 Lbs.	10 Cu Ft	\$ 5,463
BA-MC-V2A-36-SA	36" Adder	36 ¹ / ₂ "	30 ³ / ₄ "	48"	150 Lbs.	7 Cu Ft	\$ 4,050
BA-MC-V2A-48-SS	48" Starter	50"	30 ³ / ₄ "	48"	230 Lbs.	11 Cu Ft	\$ 5,606
BA-MC-V2A-48-SA	48" Adder	48 ¹ / ₂ "	30 ³ / ₄ "	48"	180 Lbs.	8 Cu Ft	\$ 4,194
		Double Face Carrel Version 2: Acrylic Style:					
BA-MC-V2A-36-DS	36" Starter	38"	60"	48"	350 Lbs.	14 Cu Ft	\$ 8,538
BA-MC-V2A-36-DA	36" Adder	36 ¹ / ₂ "	60"	48"	240 Lbs.	11 Cu Ft	\$ 5,694
BA-MC-V2A-48-DS	48" Starter	50"	60"	48"	410 Lbs.	16 Cu Ft	\$ 8,769
BA-MC-V2A-48-DA	48" Adder	48 ¹ / ₂ "	60"	48"	310 Lbs.	12 Cu Ft	\$ 5,919
		Single Face Carrel Version 2: Molding Style:					
BA-MC-V2M-36-SS	36" Starter	38"	30 ³ / ₄ "	48"	200 Lbs.	10 Cu Ft	\$ 5,806
BA-MC-V2M-36-SA	36" Adder	36 ¹ / ₂ "	30 ³ / ₄ "	48"	150 Lbs.	7 Cu Ft	\$ 4,050
BA-MC-V2M-48-SS	48" Starter	50"	30 ³ / ₄ "	48"	230 Lbs.	11 Cu Ft	\$ 5,950
BA-MC-V2M-48-SA	48" Adder	48 ¹ / ₂ "	30 ³ / ₄ "	48"	180 Lbs.	8 Cu Ft	\$ 4,194
		Double Face Carrel Version 2: Molding Style:					
BA-MC-V2M-36-DS	36" Starter	38"	60"	48"	350 Lbs.	14 Cu Ft	\$ 9,044
BA-MC-V2M-36-DA	36" Adder	36 ¹ / ₂ "	60"	48"	240 Lbs.	11 Cu Ft	\$ 5,694
BA-MC-V2M-48-DS	48" Starter	50"	60"	48"	410 Lbs.	16 Cu Ft	\$ 9,275
BA-MC-V2M-48-DA	48" Adder	48 ¹ / ₂ "	60"	48"	310 Lbs.	12 Cu Ft	\$ 5,919
		Single Face Carrel Version 2: Shaker Style:					
BA-MC-V2S-36-SS	36" Starter	38"	30 ³ / ₄ "	48"	200 Lbs.	10 Cu Ft	\$ 5,313
BA-MC-V2S-36-SA	36" Adder	36 ¹ / ₂ "	30 ³ / ₄ "	48"	150 Lbs.	7 Cu Ft	\$ 4,050
BA-MC-V2S-48-SS	48" Starter	50"	30 ³ / ₄ "	48"	230 Lbs.	11 Cu Ft	\$ 5,463
BA-MC-V2S-48-SA	48" Adder	48 ¹ / ₂ "	30 ³ / ₄ "	48"	180 Lbs.	8 Cu Ft	\$ 4,194
		Double Face Carrel Version 2: Shaker Style:					
BA-MC-V2S-36-DS	36" Starter	38"	60"	48"	350 Lbs.	14 Cu Ft	\$ 8,244
BA-MC-V2S-36-DA	36" Adder	36 ¹ / ₂ "	60"	48"	240 Lbs.	11 Cu Ft	\$ 5,694
BA-MC-V2S-48-DS	48" Starter	50"	60"	48"	410 Lbs.	16 Cu Ft	\$ 8,469
BA-MC-V2S-48-DA	48" Adder	48 ¹ / ₂ "	60"	48"	310 Lbs.	12 Cu Ft	\$ 5,919

WORK SURFACE:

Tops are constructed of 1¹/₄" thick 3-ply particleboard core. Top surface is laminated with a .050" thick high pressure plastic laminate sheet and bottom surface laminated with a backing sheet not less than .020" thick for balanced construction. Front edge shall receive a 1¹/₄" thick x 2¹/₄" wide solid external hardwood knife profile with 1/2" rounded point. Work surface is 28" deep x 29" high.

END PANELS:













Version 2 - Acrylic Style: Panel frame construction consists of two 1¹/₂" x 2⁵/₈" wide solid hardwood sides, 1¹/₂" thick x 2" arched top member and a 1¹/₂" thick x 4¹/₂" wide bottom with an arched end. Center frame will be fitted with two horizontal 1¹/₂" thick x 2" wide stile members, creating a double stacked rectangle motif design. All spaces are then fitted with 3/8" thick frosted acrylic inserts. All edges of panel frame are eased.

Version 2 - Molding Style: Panel frame construction consists of a 1¹/₁₆" thick 3-ply particleboard core with plain sliced veneer both faces, two 1¹/₂" thick x 2⁵/₈" wide solid hardwood sides, 1¹/₂" thick x 2" arched top member and a 1¹/₂" thick x 4¹/₂" wide bottom with an arched end. Center frame will be fitted with two horizontal 1/2" thick x 2" wide stile members, creating a double stacked rectangle motif design. All spaces are then miter framed with 7/16" thick x 3/4" wide angled solid hardwood trim creating a raised frame effect. All edges of panel frame and trim are eased.

Version 2 - Shaker Style: Panel frame construction consists of a 1¹/₁₆" thick 3-ply particleboard core with plain sliced veneer both faces, two 1¹/₂" thick x 2⁵/₈" wide solid hardwood sides, 1¹/₂" thick x 2" arched top member and a 1¹/₂" thick x 4¹/₂" wide bottom with an arched end. Center frame will be fitted with two horizontal 1/2" thick x 2" wide stile members, creating a double stacked rectangle motif design. All edges of panel frame are eased.

BACK PANEL:

Back is constructed of 1¹/₁₆" thick 3-ply particleboard core with plain sliced veneer both faces and the top edge is banded with a 1¹/₁₆" thick x 2¹/₄" wide solid hardwood.

MODEL NUMBER	PRODUCT	W	D	H	WEIGHT	VOLUME	LIST PRICE
		Single Face Carrel Version 3: Acrylic Style:					
BA-MC-V3A-36-SS	36" Starter	38"	30 ³ / ₄ "	48"	200 Lbs.	10 Cu Ft	\$ 5,719
BA-MC-V3A-36-SA	36" Adder	36 ¹ / ₂ "	30 ³ / ₄ "	48"	150 Lbs.	7 Cu Ft	\$ 4,050
BA-MC-V3A-48-SS	48" Starter	50"	30 ³ / ₄ "	48"	230 Lbs.	11 Cu Ft	\$ 5,863
BA-MC-V3A-48-SA	48" Adder	48 ¹ / ₂ "	30 ³ / ₄ "	48"	180 Lbs.	8 Cu Ft	\$ 4,194
		Double Face Carrel Version 3: Acrylic Style:					
BA-MC-V3A-36-DS	36" Starter	38"	60"	48"	350 Lbs.	14 Cu Ft	\$ 8,694
BA-MC-V3A-36-DA	36" Adder	36 ¹ / ₂ "	60"	48"	240 Lbs.	11 Cu Ft	\$ 5,694
BA-MC-V3A-48-DS	48" Starter	50"	60"	48"	410 Lbs.	16 Cu Ft	\$ 8,919
BA-MC-V3A-48-DA	48" Adder	48 ¹ / ₂ "	60"	48"	310 Lbs.	12 Cu Ft	\$ 5,919
		Single Face Carrel Version 3: Molding Style:					
BA-MC-V3M-36-SS	36" Starter	38"	30 ³ / ₄ "	48"	200 Lbs.	10 Cu Ft	\$ 6,044
BA-MC-V3M-36-SA	36" Adder	36 ¹ / ₂ "	30 ³ / ₄ "	48"	150 Lbs.	7 Cu Ft	\$ 4,050
BA-MC-V3M-48-SS	48" Starter	50"	30 ³ / ₄ "	48"	230 Lbs.	11 Cu Ft	\$ 6,188
BA-MC-V3M-48-SA	48" Adder	48 ¹ / ₂ "	30 ³ / ₄ "	48"	180 Lbs.	8 Cu Ft	\$ 4,194
		Double Face Carrel Version 3: Molding Style:					
BA-MC-V3M-36-DS	36" Starter	38"	60"	48"	350 Lbs.	14 Cu Ft	\$ 9,431
BA-MC-V3M-36-DA	36" Adder	36 ¹ / ₂ "	60"	48"	240 Lbs.	11 Cu Ft	\$ 5,694
BA-MC-V3M-48-DS	48" Starter	50"	60"	48"	410 Lbs.	16 Cu Ft	\$ 9,663
BA-MC-V3M-48-DA	48" Adder	48 ¹ / ₂ "	60"	48"	310 Lbs.	12 Cu Ft	\$ 5,919
		Single Face Carrel Version 3: Shaker Style:					
BA-MC-V3S-36-SS	36" Starter	38"	30 ³ / ₄ "	48"	200 Lbs.	10 Cu Ft	\$ 5,544
BA-MC-V3S-36-SA	36" Adder	36 ¹ / ₂ "	30 ³ / ₄ "	48"	150 Lbs.	7 Cu Ft	\$ 4,050
BA-MC-V3S-48-SS	48" Starter	50"	30 ³ / ₄ "	48"	230 Lbs.	11 Cu Ft	\$ 5,688
BA-MC-V3S-48-SA	48" Adder	48 ¹ / ₂ "	30 ³ / ₄ "	48"	180 Lbs.	8 Cu Ft	\$ 4,194
		Double Face Carrel Version 3: Shaker Style:					
BA-MC-V3S-36-DS	36" Starter	38"	60"	48"	350 Lbs.	14 Cu Ft	\$ 8,338
BA-MC-V3S-36-DA	36" Adder	36 ¹ / ₂ "	60"	48"	240 Lbs.	11 Cu Ft	\$ 5,694
BA-MC-V3S-48-DS	48" Starter	50"	60"	48"	410 Lbs.	16 Cu Ft	\$ 8,569
BA-MC-V3S-48-DA	48" Adder	48 ¹ / ₂ "	60"	48"	310 Lbs.	12 Cu Ft	\$ 5,919

WORK SURFACE:

Tops are constructed of 1¹/₄" thick 3-ply particleboard core. Top surface is laminated with a .050" thick high pressure plastic laminate sheet and bottom surface laminated with a backing sheet not less than .020" thick for balanced construction. Front edge shall receive a 1¹/₄" thick x 2¹/₄" wide solid external hardwood knife profile with 1¹/₂" rounded point. Work surface is 28" deep x 29" high.

END PANELS:

























Version 3 - Acrylic Style: Panel frame construction consists of two 1¹/₂" x 2⁵/₈" wide solid hardwood sides, 1¹/₂" thick x 2" arched top member and a 1¹/₂" thick x 4¹/₂" wide bottom with an arched end. Center frame will be fitted with two horizontal and one vertical 1¹/₂" thick x 2" wide stile members, creating a three rectangular motif design. All spaces are then fitted with 3³/₈" thick frosted acrylic inserts. All edges of panel frame are eased.

Version 3 - Molding Style: Panel frame construction consists of a 1¹/₁₆" thick 3-ply particleboard core with plain sliced veneer both faces, two 1¹/₂" thick x 2⁵/₈" wide solid hardwood sides, 1¹/₂" thick x 2" arched top member and a 1¹/₂" thick x 4¹/₂" wide bottom with an arched end. Center frame will be fitted with two horizontal and one vertical 1¹/₂" thick x 2" wide stile members, creating a three rectangular motif design. All spaces are then miter framed with 7⁷/₁₆" thick x 3³/₄" wide angled solid hardwood trim creating a raised frame effect. All edges of panel frame and trim are eased.

Version 3 - Shaker Style: Panel frame construction consists of a 1¹/₁₆" thick 3-ply particleboard core with plain sliced veneer both faces, two 1¹/₂" thick x 2⁵/₈" wide solid hardwood sides, 1¹/₂" thick x 2" arched top member and a 1¹/₂" thick x 4¹/₂" wide bottom with an arched end. Center frame will be fitted with two horizontal and one vertical 1¹/₂" thick x 2" wide stile members, creating a three rectangular motif design. All edges of panel frame are eased.

BACK PANEL:

Back is constructed of 1¹/₁₆" thick 3-ply particleboard core with plain sliced veneer both faces and the top edge is banded with a 1¹/₁₆" thick x 2¹/₄" wide solid hardwood.

MODEL NUMBER	PRODUCT	W	D	H	WEIGHT	VOLUME	LIST PRICE
Single Face Carrel Version 4: Acrylic Style:							
 BA-MC-V4A-36-SS	36" Starter	38"	30 ³ / ₄ "	48"	200 Lbs.	10 Cu Ft	\$ 5,719
 BA-MC-V4A-36-SA	36" Adder	36 ¹ / ₂ "	30 ³ / ₄ "	48"	150 Lbs.	7 Cu Ft	\$ 4,050
 BA-MC-V4A-48-SS	48" Starter	50"	30 ³ / ₄ "	48"	230 Lbs.	11 Cu Ft	\$ 5,863
 BA-MC-V4A-48-SA	48" Adder	48 ¹ / ₂ "	30 ³ / ₄ "	48"	180 Lbs.	8 Cu Ft	\$ 4,194
Double Face Carrel Version 4: Acrylic Style:							
 BA-MC-V4A-36-DS	36" Starter	38"	60"	48"	350 Lbs.	14 Cu Ft	\$ 8,694
 BA-MC-V4A-36-DA	36" Adder	36 ¹ / ₂ "	60"	48"	240 Lbs.	11 Cu Ft	\$ 5,694
 BA-MC-V4A-48-DS	48" Starter	50"	60"	48"	410 Lbs.	16 Cu Ft	\$ 8,919
 BA-MC-V4A-48-DA	48" Adder	48 ¹ / ₂ "	60"	48"	310 Lbs.	12 Cu Ft	\$ 5,919
Single Face Carrel Version 4: Molding Style:							
 BA-MC-V4M-36-SS	36" Starter	38"	30 ³ / ₄ "	48"	200 Lbs.	10 Cu Ft	\$ 6,044
 BA-MC-V4M-36-SA	36" Adder	36 ¹ / ₂ "	30 ³ / ₄ "	48"	150 Lbs.	7 Cu Ft	\$ 4,050
 BA-MC-V4M-48-SS	48" Starter	50"	30 ³ / ₄ "	48"	230 Lbs.	11 Cu Ft	\$ 6,188
 BA-MC-V4M-48-SA	48" Adder	48 ¹ / ₂ "	30 ³ / ₄ "	48"	180 Lbs.	8 Cu Ft	\$ 4,194
Double Face Carrel Version 4: Molding Style:							
 BA-MC-V4M-36-DS	36" Starter	38"	60"	48"	350 Lbs.	14 Cu Ft	\$ 9,431
 BA-MC-V4M-36-DA	36" Adder	36 ¹ / ₂ "	60"	48"	240 Lbs.	11 Cu Ft	\$ 5,694
 BA-MC-V4M-48-DS	48" Starter	50"	60"	48"	410 Lbs.	16 Cu Ft	\$ 9,663
 BA-MC-V4M-48-DA	48" Adder	48 ¹ / ₂ "	60"	48"	310 Lbs.	12 Cu Ft	\$ 5,919
Single Face Carrel Version 4: Shaker Style:							
 BA-MC-V4S-36-SS	36" Starter	38"	30 ³ / ₄ "	48"	200 Lbs.	10 Cu Ft	\$ 5,544
 BA-MC-V4S-36-SA	36" Adder	36 ¹ / ₂ "	30 ³ / ₄ "	48"	150 Lbs.	7 Cu Ft	\$ 4,050
 BA-MC-V4S-48-SS	48" Starter	50"	30 ³ / ₄ "	48"	230 Lbs.	11 Cu Ft	\$ 5,688
 BA-MC-V4S-48-SA	48" Adder	48 ¹ / ₂ "	30 ³ / ₄ "	48"	180 Lbs.	8 Cu Ft	\$ 4,194
Double Face Carrel Version 4: Shaker Style:							
 BA-MC-V4S-36-DS	36" Starter	38"	60"	48"	350 Lbs.	14 Cu Ft	\$ 8,338
 BA-MC-V4S-36-DA	36" Adder	36 ¹ / ₂ "	60"	48"	240 Lbs.	11 Cu Ft	\$ 5,694
 BA-MC-V4S-48-DS	48" Starter	50"	60"	48"	410 Lbs.	16 Cu Ft	\$ 8,569
 BA-MC-V4S-48-DA	48" Adder	48 ¹ / ₂ "	60"	48"	310 Lbs.	12 Cu Ft	\$ 5,919

























WORK SURFACE:
Tops are constructed of 1¹/₄" thick 3-ply particleboard core. Top surface is laminated with a .050" thick high pressure plastic laminate sheet and bottom surface laminated with a backing sheet not less than .020" thick for balanced construction. Front edge shall receive a 1¹/₄" thick x 2¹/₄" wide solid external hardwood knife profile with 1¹/₂" rounded point. Work surface is 28" deep x 29" high.

END PANELS:
Version 4 - Acrylic Style: Panel frame construction consists of two 1¹/₂" x 2⁵/₈" wide solid hardwood sides, 1¹/₂" thick x 2" arched top member and a 1¹/₂" thick x 4¹/₂" wide bottom with an arched end. Center frame will be fitted with two horizontal and one vertical 1¹/₂" thick x 2" wide stile members, creating a rectangle and square motif design. All spaces are then fitted with 3³/₈" thick frosted acrylic inserts. All edges of panel frame are eased.

Version 4 - Molding Style: Panel frame construction consists of a 1¹/₁₆" thick 3-ply particleboard core with plain sliced veneer both faces, two 1¹/₂" thick x 2⁵/₈" wide solid hardwood sides, 1¹/₂" thick x 2" arched top member and a 1¹/₂" thick x 4¹/₂" wide bottom with an arched end. Center frame will be fitted with two horizontal and one vertical 1¹/₂" thick x 2" wide stile members, creating a rectangle and square motif design. All spaces are then miter framed with 7⁷/₁₆" thick x 3³/₄" wide angled solid hardwood trim creating a raised frame effect. All edges of panel frame and trim are eased.

Version 4 - Shaker Style: Panel frame construction consists of a 1¹/₁₆" thick 3-ply particleboard core with plain sliced veneer both faces, two 1¹/₂" thick x 2⁵/₈" wide solid hardwood sides, 1¹/₂" thick x 2" arched top member and a 1¹/₂" thick x 4¹/₂" wide bottom with an arched end. Center frame will be fitted with two horizontal and one vertical 1¹/₂" thick x 2" wide stile members, creating a rectangle and square motif design. All edges of panel frame are eased.

BACK PANEL:
Back is constructed of 1¹/₁₆" thick 3-ply particleboard core with plain sliced veneer both faces and the top edge is banded with a 1¹/₁₆" thick x 2¹/₄" wide solid hardwood.

MODEL NUMBER	PRODUCT	W	D	H	WEIGHT	VOLUME	LIST PRICE
Single Face Carrel Version 5: Acrylic Style:							
 BA-MC-V5A-36-SS	36" Starter	38"	30 ³ / ₄ "	48"	200 Lbs.	10 Cu Ft	\$ 5,719
 BA-MC-V5A-36-SA	36" Adder	36 ¹ / ₂ "	30 ³ / ₄ "	48"	150 Lbs.	7 Cu Ft	\$ 4,050
 BA-MC-V5A-48-SS	48" Starter	50"	30 ³ / ₄ "	48"	230 Lbs.	11 Cu Ft	\$ 5,863
 BA-MC-V5A-48-SA	48" Adder	48 ¹ / ₂ "	30 ³ / ₄ "	48"	180 Lbs.	8 Cu Ft	\$ 4,194
Double Face Carrel Version 5: Acrylic Style:							
 BA-MC-V5A-36-DS	36" Starter	38"	60"	48"	350 Lbs.	14 Cu Ft	\$ 8,694
 BA-MC-V5A-36-DA	36" Adder	36 ¹ / ₂ "	60"	48"	240 Lbs.	11 Cu Ft	\$ 5,694
 BA-MC-V5A-48-DS	48" Starter	50"	60"	48"	410 Lbs.	16 Cu Ft	\$ 8,919
 BA-MC-V5A-48-DA	48" Adder	48 ¹ / ₂ "	60"	48"	310 Lbs.	12 Cu Ft	\$ 5,919
Single Face Carrel Version 5: Molding Style:							
 BA-MC-V5M-36-SS	36" Starter	38"	30 ³ / ₄ "	48"	200 Lbs.	10 Cu Ft	\$ 6,044
 BA-MC-V5M-36-SA	36" Adder	36 ¹ / ₂ "	30 ³ / ₄ "	48"	150 Lbs.	7 Cu Ft	\$ 4,050
 BA-MC-V5M-48-SS	48" Starter	50"	30 ³ / ₄ "	48"	230 Lbs.	11 Cu Ft	\$ 6,188
 BA-MC-V5M-48-SA	48" Adder	48 ¹ / ₂ "	30 ³ / ₄ "	48"	180 Lbs.	8 Cu Ft	\$ 4,194
Double Face Carrel Version 5: Molding Style:							
 BA-MC-V5M-36-DS	36" Starter	38"	60"	48"	350 Lbs.	14 Cu Ft	\$ 9,431
 BA-MC-V5M-36-DA	36" Adder	36 ¹ / ₂ "	60"	48"	240 Lbs.	11 Cu Ft	\$ 5,694
 BA-MC-V5M-48-DS	48" Starter	50"	60"	48"	410 Lbs.	16 Cu Ft	\$ 9,663
 BA-MC-V5M-48-DA	48" Adder	48 ¹ / ₂ "	60"	48"	310 Lbs.	12 Cu Ft	\$ 5,919
Single Face Carrel Version 5: Shaker Style:							
 BA-MC-V5S-36-SS	36" Starter	38"	30 ³ / ₄ "	48"	200 Lbs.	10 Cu Ft	\$ 5,544
 BA-MC-V5S-36-SA	36" Adder	36 ¹ / ₂ "	30 ³ / ₄ "	48"	150 Lbs.	7 Cu Ft	\$ 4,050
 BA-MC-V5S-48-SS	48" Starter	50"	30 ³ / ₄ "	48"	230 Lbs.	11 Cu Ft	\$ 5,688
 BA-MC-V5S-48-SA	48" Adder	48 ¹ / ₂ "	30 ³ / ₄ "	48"	180 Lbs.	8 Cu Ft	\$ 4,194
Double Face Carrel Version 5: Shaker Style:							
 BA-MC-V5S-36-DS	36" Starter	38"	60"	48"	350 Lbs.	14 Cu Ft	\$ 8,338
 BA-MC-V5S-36-DA	36" Adder	36 ¹ / ₂ "	60"	48"	240 Lbs.	11 Cu Ft	\$ 5,694
 BA-MC-V5S-48-DS	48" Starter	50"	60"	48"	410 Lbs.	16 Cu Ft	\$ 8,569
 BA-MC-V5S-48-DA	48" Adder	48 ¹ / ₂ "	60"	48"	310 Lbs.	12 Cu Ft	\$ 5,919

























WORK SURFACE:
Tops are constructed of 1¹/₄" thick 3-ply particleboard core. Top surface is laminated with a .050" thick high pressure plastic laminate sheet and bottom surface laminated with a backing sheet not less than .020" thick for balanced construction. Front edge shall receive a 1¹/₄" thick x 2¹/₄" wide solid external hardwood knife profile with 1¹/₂" rounded point. Work surface is 28" deep x 29" high.

END PANELS:
Version 5 - Acrylic Style: Panel frame construction consists of two 1¹/₂" x 2⁵/₈" wide solid hardwood sides, 1¹/₂" thick x 2" arched top member and a 1¹/₂" thick x 4¹/₂" wide bottom with an arched end. Center frame will be fitted with two horizontal and one vertical 1¹/₂" thick x 2" wide stile members, creating a four rectangular motif design. All spaces are then fitted with 3³/₈" thick frosted acrylic inserts. All edges of panel frame are eased.

Version 5 - Molding Style: Panel frame construction consists of a 1¹/₁₆" thick 3-ply particleboard core with plain sliced veneer both faces, two 1¹/₂" thick x 2⁵/₈" wide solid hardwood sides, 1¹/₂" thick x 2" arched top member and a 1¹/₂" thick x 4¹/₂" wide bottom with an arched end. Center frame will be fitted with two horizontal and one vertical 1¹/₂" thick x 2" wide stile members, creating a four rectangular motif design. All spaces are then miter framed with 7⁷/₁₆" thick x 3³/₄" wide angled solid hardwood trim creating a raised frame effect. All edges of panel frame and trim are eased.

Version 5 - Shaker Style: Panel frame construction consists of a 1¹/₁₆" thick 3-ply particleboard core with plain sliced veneer both faces, two 1¹/₂" thick x 2⁵/₈" wide solid hardwood sides, 1¹/₂" thick x 2" arched top member and a 1¹/₂" thick x 4¹/₂" wide bottom with an arched end. Center frame will be fitted with two horizontal and one vertical 1¹/₂" thick x 2" wide stile members, creating a four rectangular motif design. All edges of panel frame are eased.

BACK PANEL:
Back is constructed of 1¹/₁₆" thick 3-ply particleboard core with plain sliced veneer both faces and the top edge is banded with a 1¹/₁₆" thick x 2¹/₄" wide solid hardwood.

MODEL NUMBER	PRODUCT	W	D	H	WEIGHT	VOLUME	LIST PRICE
Single Face Carrel Version 6: Acrylic Style:							
	BA-MC-V6A-36-SS 36" Starter	38"	30 ³ / ₄ "	48"	200 Lbs.	10 Cu Ft	\$ 5,288
	BA-MC-V6A-36-SA 36" Adder	36 ¹ / ₂ "	30 ³ / ₄ "	48"	150 Lbs.	7 Cu Ft	\$ 4,050
	BA-MC-V6A-48-SS 48" Starter	50"	30 ³ / ₄ "	48"	230 Lbs.	11 Cu Ft	\$ 5,431
	BA-MC-V6A-48-SA 48" Adder	48 ¹ / ₂ "	30 ³ / ₄ "	48"	180 Lbs.	8 Cu Ft	\$ 4,194
Double Face Carrel Version 6: Acrylic Style:							
	BA-MC-V6A-36-DS 36" Starter	38"	60"	48"	350 Lbs.	14 Cu Ft	\$ 8,275
	BA-MC-V6A-36-DA 36" Adder	36 ¹ / ₂ "	60"	48"	240 Lbs.	11 Cu Ft	\$ 5,694
	BA-MC-V6A-48-DS 48" Starter	50"	60"	48"	410 Lbs.	16 Cu Ft	\$ 8,500
	BA-MC-V6A-48-DA 48" Adder	48 ¹ / ₂ "	60"	48"	310 Lbs.	12 Cu Ft	\$ 5,919
Single Face Carrel Version 6: Molding Style:							
	BA-MC-V6M-36-SS 36" Starter	38"	30 ³ / ₄ "	48"	200 Lbs.	10 Cu Ft	\$ 5,650
	BA-MC-V6M-36-SA 36" Adder	36 ¹ / ₂ "	30 ³ / ₄ "	48"	150 Lbs.	7 Cu Ft	\$ 4,050
	BA-MC-V6M-48-SS 48" Starter	50"	30 ³ / ₄ "	48"	230 Lbs.	11 Cu Ft	\$ 5,794
	BA-MC-V6M-48-SA 48" Adder	48 ¹ / ₂ "	30 ³ / ₄ "	48"	180 Lbs.	8 Cu Ft	\$ 4,194
Double Face Carrel Version 6: Molding Style:							
	BA-MC-V6M-36-DS 36" Starter	38"	60"	48"	350 Lbs.	14 Cu Ft	\$ 8,731
	BA-MC-V6M-36-DA 36" Adder	36 ¹ / ₂ "	60"	48"	240 Lbs.	11 Cu Ft	\$ 5,694
	BA-MC-V6M-48-DS 48" Starter	50"	60"	48"	410 Lbs.	16 Cu Ft	\$ 8,956
	BA-MC-V6M-48-DA 48" Adder	48 ¹ / ₂ "	60"	48"	310 Lbs.	12 Cu Ft	\$ 5,919
Single Face Carrel Version 6: Shaker Style:							
	BA-MC-V6S-36-SS 36" Starter	38"	30 ³ / ₄ "	48"	200 Lbs.	10 Cu Ft	\$ 5,169
	BA-MC-V6S-36-SA 36" Adder	36 ¹ / ₂ "	30 ³ / ₄ "	48"	150 Lbs.	7 Cu Ft	\$ 4,050
	BA-MC-V6S-48-SS 48" Starter	50"	30 ³ / ₄ "	48"	230 Lbs.	11 Cu Ft	\$ 5,313
	BA-MC-V6S-48-SA 48" Adder	48 ¹ / ₂ "	30 ³ / ₄ "	48"	180 Lbs.	8 Cu Ft	\$ 4,194
Double Face Carrel Version 6: Shaker Style:							
	BA-MC-V6S-36-DS 36" Starter	38"	60"	48"	350 Lbs.	14 Cu Ft	\$ 8,038
	BA-MC-V6S-36-DA 36" Adder	36 ¹ / ₂ "	60"	48"	240 Lbs.	11 Cu Ft	\$ 5,694
	BA-MC-V6S-48-DS 48" Starter	50"	60"	48"	410 Lbs.	16 Cu Ft	\$ 8,263
	BA-MC-V6S-48-DA 48" Adder	48 ¹ / ₂ "	60"	48"	310 Lbs.	12 Cu Ft	\$ 5,919

WORK SURFACE:

Tops are constructed of 1¹/₄" thick 3-ply particleboard core. Top surface is laminated with a .050" thick high pressure plastic laminate sheet and bottom surface laminated with a backing sheet not less than .020" thick for balanced construction. Front edge shall receive a 1¹/₄" thick x 2¹/₄" wide solid external hardwood knife profile with 1/2" rounded point. Work surface is 28" deep x 29" high.

END PANELS:



Version 6 - Acrylic Style: Panel frame construction consists of two 1¹/₂" x 2⁵/₈" wide solid hardwood sides, 1¹/₂" thick x 2" arched top member and a 1¹/₂" thick x 4¹/₂" wide bottom with an arched end. Center frame will be fitted with one horizontal 1¹/₂" thick x 2" wide stile members then fitted with 3/8" thick frosted acrylic inserts. All edges of panel frame are eased.

Version 6 - Molding Style: Panel frame construction consists of a 1¹/₁₆" thick 3-ply particleboard core with plain sliced veneer both faces, two 1¹/₂" thick x 2⁵/₈" wide solid hardwood sides, 1¹/₂" thick x 2" arched top member and a 1¹/₂" thick x 4¹/₂" wide bottom with an arched end. Center frame will be fitted with one horizontal 1¹/₂" thick x 2" wide stile member. Upper portion will be fitted with 3/8" thick frosted acrylic insert. Lower portion is miter framed with 7/16" thick x 3/4" wide angled solid hardwood trim creating a raised frame effect. All edges of panel frame and trim are eased.

Version 6 - Shaker Style: Panel frame construction consists of a 1¹/₁₆" thick 3-ply particleboard core with plain sliced veneer both faces, two 1¹/₂" thick x 2⁵/₈" wide solid hardwood sides, 1¹/₂" thick x 2" arched top member and a 1¹/₂" thick x 4¹/₂" wide bottom with an arched end. Center frame will be fitted with one horizontal 1¹/₂" thick x 2" wide stile member. Upper portion will be fitted with 3/8" thick frosted acrylic insert. All edges of panel frame are eased.

BACK PANEL:

Back is constructed of 1¹/₁₆" thick 3-ply particleboard core with plain sliced veneer both faces and the top edge is banded with a 1¹/₁₆" thick x 2¹/₄" wide solid hardwood.

	MODEL NUMBER	PRODUCT	W	D	H	WEIGHT	VOLUME	LIST PRICE	DESCRIPTION
	BA-PAC-1-V1A-29	1 Person PAC Table, V1 Acrylic: Sitting Height	36"	36"	37"	130 Lbs.	12 Cu Ft	\$ 4,925	<p>WORK SURFACE: Tops are constructed of 1 1/4" thick 3-ply particleboard core. Top surface is laminated with a .050" thick high pressure plastic laminate sheet and bottom surface laminated with a backing sheet not less than .020" thick for balanced construction. Surrounding edges will be 1 1/4" thick x 2 1/4" wide solid external hardwood knife profile with 1/2" rounded point and shall be mitered and radiused at corners.</p> <p>SUPERSTRUCTURE: Side panels constructed of 3/4" thick x 8" high solid hardwood and back panels constructed of 3/4" x 7 3/4" high veneer plywood core, top edge banded with 1/4" external hardwood.</p> <p>END PANELS: Panel frame construction consists of two 1 1/2" thick x 2 5/8" wide solid hardwood sides, 1 1/2" thick x 3 1/2" top member and a 1 1/2" thick x 5" wide bottom with a 2 1/2" arched center. Center frame will be fitted with one horizontal and two vertical 1 1/2" thick x 2" wide stile members, creating a rectangle and square motif design. All spaces are then fitted with 3/8" thick frosted acrylic inserts. All edges of panel frame are eased.</p> <p>ELECTRICAL ACCESSORIES: Each seating position shall receive a 3" diameter black plastic grommet and a black metal j-channel for wire management.</p>
	BA-PAC-1-V1A-32	Wheelchair Accessible	36"	36"	40"	130 Lbs.	12 Cu Ft	\$ 5,013	
	BA-PAC-1-V1A-39	Standing Height	36"	36"	47"	135 Lbs.	12 Cu Ft	\$ 5,244	
	BA-PAC-2-V1A-29	2 Person PAC Table, V1 Acrylic: Sitting Height	72"	36"	37"	200 Lbs.	23 Cu Ft	\$ 5,669	
	BA-PAC-2-V1A-32	Wheelchair Accessible	72"	36"	40"	200 Lbs.	23 Cu Ft	\$ 5,763	
	BA-PAC-2-V1A-39	Standing Height	72"	36"	47"	205 Lbs.	23 Cu Ft	\$ 6,013	
	BA-PAC-3-V1A-29	3 Person PAC Table, V1 Acrylic: Sitting Height	90"	36"	37"	250 Lbs.	28 Cu Ft	\$ 6,238	
	BA-PAC-3-V1A-32	Wheelchair Accessible	90"	36"	40"	250 Lbs.	28 Cu Ft	\$ 6,325	
	BA-PAC-3-V1A-39	Standing Height	90"	36"	47"	260 Lbs.	28 Cu Ft	\$ 6,588	

MODEL NUMBER	PRODUCT	W	D	H	WEIGHT	VOLUME	LIST PRICE	
	1 Person PAC Table, V1 Molding: Sitting Height	36"	36"	37"	130 Lbs.	12 Cu Ft	\$ 5,425	
	BA-PAC-1-V1M-29							
	BA-PAC-1-V1M-32	Wheelchair Accessible	36"	36"	40"	130 Lbs.	12 Cu Ft	\$ 5,519
	BA-PAC-1-V1M-39	Standing Height	36"	36"	47"	135 Lbs.	12 Cu Ft	\$ 5,756
	2 Person PAC Table, V1 Molding: Sitting Height	72"	36"	37"	200 Lbs.	23 Cu Ft	\$ 6,169	
	BA-PAC-2-V1M-29							
	BA-PAC-2-V1M-32	Wheelchair Accessible	72"	36"	40"	200 Lbs.	23 Cu Ft	\$ 6,263
	BA-PAC-2-V1M-39	Standing Height	72"	36"	47"	205 Lbs.	23 Cu Ft	\$ 6,531
	3 Person PAC Table, V1 Molding: Sitting Height	90"	36"	37"	250 Lbs.	28 Cu Ft	\$ 6,731	
	BA-PAC-3-V1M-29							
	BA-PAC-3-V1M-32	Wheelchair Accessible	90"	36"	40"	250 Lbs.	28 Cu Ft	\$ 6,831
	BA-PAC-3-V1M-39	Standing Height	90"	36"	47"	260 Lbs.	28 Cu Ft	\$ 7,106

WORK SURFACE:

Tops are constructed of 1 1/4" thick 3-ply particleboard core. Top surface is laminated with a .050" thick high pressure plastic laminate sheet and bottom surface laminated with a backing sheet not less than .020" thick for balanced construction. Surrounding edges will be 1 1/4" thick x 2 1/4" wide solid external hardwood knife profile with 1/2" rounded point and shall be mitered and radiused at corners.

SUPERSTRUCTURE:



Side panels constructed of 3/4" thick x 8" high solid hardwood and back panels constructed of 3/4" x 7 3/4" high veneer plywood core, top edge banded with 1/4" external hardwood.



END PANELS:



Panel frame construction consists of a 1 1/16" thick 3-ply particleboard core with plain sliced veneer both faces, two 1 1/2" thick x 2 5/8" wide solid hardwood sides, 1 1/2" thick x 3 1/2" top member and a 1 1/2" thick x 5" wide bottom with a 2 1/2" arched center. Center frame will be fitted with one horizontal and two vertical 1/2" thick x 2" wide stile members, creating a rectangle and square motif design. All spaces are then miter framed with 7/16" thick x 3/4" wide angled solid hardwood trim creating a raised frame effect. All edges of panel frame and trim are eased.



ELECTRICAL ACCESSORIES:



Each seating position shall receive a 3" diameter black plastic grommet and a black metal j-channel for wire management.



MODEL NUMBER	PRODUCT	W	D	H	WEIGHT	VOLUME	LIST PRICE	DESCRIPTION	
	BA-PAC-1-V1S-29	1 Person PAC Table, V1 Shaker: Sitting Height	36"	36"	37"	130 Lbs.	12 Cu Ft	\$ 4,706	<p>WORK SURFACE: Tops are constructed of 1 1/4" thick 3-ply particleboard core. Top surface is laminated with a .050" thick high pressure plastic laminate sheet and bottom surface laminated with a backing sheet not less than .020" thick for balanced construction. Surrounding edges will be 1 1/4" thick x 2 1/4" wide solid external hardwood knife profile with 1/2" rounded point and shall be mitered and radiused at corners.</p> <p>SUPERSTRUCTURE: Side panels constructed of 3/4" thick x 8" high solid hardwood and back panels constructed of 3/4" x 7 3/4" high veneer plywood core, top edge banded with 1/4" external hardwood.</p> <p>END PANELS: Panel frame construction consists of a 1 1/16" thick 3-ply particleboard core with plain sliced veneer both faces, two 1 1/2" thick x 2 5/8" wide solid hardwood sides, 1 1/2" thick x 3 1/2" top member and a 1 1/2" thick x 5" wide bottom with a 2 1/2" arched center. Center frame will be fitted with one horizontal and two vertical 1/2" thick x 2" wide stile members, creating a rectangle and square motif design. All edges of panel frame and trim are eased.</p> <p>ELECTRICAL ACCESSORIES: Each seating position shall receive a 3" diameter black plastic grommet and a black metal j-channel for wire management.</p>
	BA-PAC-1-V1S-32	Wheelchair Accessible	36"	36"	40"	130 Lbs.	12 Cu Ft	\$ 4,756	
	BA-PAC-1-V1S-39	Standing Height	36"	36"	47"	135 Lbs.	12 Cu Ft	\$ 4,900	
	BA-PAC-2-V1S-29	2 Person PAC Table, V1 Shaker: Sitting Height	72"	36"	37"	200 Lbs.	23 Cu Ft	\$ 5,450	
	BA-PAC-2-V1S-32	Wheelchair Accessible	72"	36"	40"	200 Lbs.	23 Cu Ft	\$ 5,506	
	BA-PAC-2-V1S-39	Standing Height	72"	36"	47"	205 Lbs.	23 Cu Ft	\$ 5,669	
	BA-PAC-3-V1S-29	3 Person PAC Table, V1 Shaker: Sitting Height	90"	36"	37"	250 Lbs.	28 Cu Ft	\$ 6,019	
	BA-PAC-3-V1S-32	Wheelchair Accessible	90"	36"	40"	250 Lbs.	28 Cu Ft	\$ 6,069	
	BA-PAC-3-V1S-39	Standing Height	90"	36"	47"	260 Lbs.	28 Cu Ft	\$ 6,244	



	MODEL NUMBER	PRODUCT	W	D	H	WEIGHT	VOLUME	LIST PRICE	DESCRIPTION
	BA-PAC-1-V2A-29	1 Person PAC Table, V2 Acrylic: Sitting Height	36"	36"	37"	130 Lbs.	12 Cu Ft	\$ 4,688	<p>WORK SURFACE: Tops are constructed of 1 1/4" thick 3-ply particleboard core. Top surface is laminated with a .050" thick high pressure plastic laminate sheet and bottom surface laminated with a backing sheet not less than .020" thick for balanced construction. Surrounding edges will be 1 1/4" thick x 2 1/4" wide solid external hardwood knife profile with 1/2" rounded point and shall be mitered and radiused at corners.</p> <p>SUPERSTRUCTURE: Side panels constructed of 3/4" thick x 8" high solid hardwood and back panels constructed of 3/4" x 7 3/4" high veneer plywood core, top edge banded with 1/4" external hardwood.</p> <p>END PANELS: Panel frame construction consists of two 1 1/2" thick x 2 5/8" wide solid hardwood sides, 1 1/2" thick x 3 1/2" top member and a 1 1/2" thick x 5" wide bottom with a 2 1/2" arched center. Center frame will be fitted with one horizontal 1 1/2" thick x 2" wide stile member, creating a double stacked rectangle motif design. All spaces are then fitted with 3/8" thick frosted acrylic inserts. All edges of panel frame are eased.</p> <p>ELECTRICAL ACCESSORIES: Each seating position shall receive a 3" diameter black plastic grommet and a black metal j-channel for wire management.</p>
	BA-PAC-1-V2A-32	Wheelchair Accessible	36"	36"	40"	130 Lbs.	12 Cu Ft	\$ 4,769	
	BA-PAC-1-V2A-39	Standing Height	36"	36"	47"	135 Lbs.	12 Cu Ft	\$ 4,969	
	BA-PAC-2-V2A-29	2 Person PAC Table, V2 Acrylic: Sitting Height	72"	36"	37"	200 Lbs.	23 Cu Ft	\$ 5,438	
	BA-PAC-2-V2A-32	Wheelchair Accessible	72"	36"	40"	200 Lbs.	23 Cu Ft	\$ 5,519	
	BA-PAC-2-V2A-39	Standing Height	72"	36"	47"	205 Lbs.	23 Cu Ft	\$ 5,744	
	BA-PAC-3-V2A-29	3 Person PAC Table, V2 Acrylic: Sitting Height	90"	36"	37"	250 Lbs.	28 Cu Ft	\$ 6,000	
	BA-PAC-3-V2A-32	Wheelchair Accessible	90"	36"	40"	250 Lbs.	28 Cu Ft	\$ 6,081	
	BA-PAC-3-V2A-39	Standing Height	90"	36"	47"	260 Lbs.	28 Cu Ft	\$ 6,319	



	MODEL NUMBER	PRODUCT	W	D	H	WEIGHT	VOLUME	LIST PRICE	DESCRIPTION
	BA-PAC-1-V2M-29	1 Person PAC Table, V2 Molding: Sitting Height	36"	36"	37"	130 Lbs.	12 Cu Ft	\$ 5,050	<p>WORK SURFACE: Tops are constructed of 1 1/4" thick 3-ply particleboard core. Top surface is laminated with a .050" thick high pressure plastic laminate sheet and bottom surface laminated with a backing sheet not less than .020" thick for balanced construction. Surrounding edges will be 1 1/4" thick x 2 1/4" wide solid external hardwood knife profile with 1/2" rounded point and shall be mitered and radiused at corners.</p> <p>SUPERSTRUCTURE: Side panels constructed of 3/4" thick x 8" high solid hardwood and back panels constructed of 3/4" x 7 3/4" high veneer plywood core, top edge banded with 1/4" external hardwood.</p> <p>END PANELS: Panel frame construction consists of a 1 1/16" thick 3-ply particleboard core with plain sliced veneer both faces, two 1 1/2" thick x 2 5/8" wide solid hardwood sides, 1 1/2" thick x 3 1/2" top member and a 1 1/2" thick x 5" wide bottom with a 2 1/2" arched center. Center frame will be fitted with one horizontal 1/2" thick x 2" wide stile member, creating a double stacked rectangle motif design. All spaces are then miter framed with 7/16" thick x 3/4" wide angled solid hardwood trim creating a raised frame effect. All edges of panel frame and trim are eased.</p> <p>ELECTRICAL ACCESSORIES: Each seating position shall receive a 3" diameter black plastic grommet and a black metal j-channel for wire management.</p>
	BA-PAC-1-V2M-32	Wheelchair Accessible	36"	36"	40"	130 Lbs.	12 Cu Ft	\$ 5,125	
	BA-PAC-1-V2M-39	Standing Height	36"	36"	47"	135 Lbs.	12 Cu Ft	\$ 5,313	
	BA-PAC-2-V2M-29	2 Person PAC Table, V2 Molding: Sitting Height	72"	36"	37"	200 Lbs.	23 Cu Ft	\$ 5,794	
	BA-PAC-2-V2M-32	Wheelchair Accessible	72"	36"	40"	200 Lbs.	23 Cu Ft	\$ 5,869	
	BA-PAC-2-V2M-39	Standing Height	72"	36"	47"	205 Lbs.	23 Cu Ft	\$ 6,088	
	BA-PAC-3-V2M-29	3 Person PAC Table, V2 Molding: Sitting Height	90"	36"	37"	250 Lbs.	28 Cu Ft	\$ 6,363	
	BA-PAC-3-V2M-32	Wheelchair Accessible	90"	36"	40"	250 Lbs.	28 Cu Ft	\$ 6,438	
	BA-PAC-3-V2M-39	Standing Height	90"	36"	47"	260 Lbs.	28 Cu Ft	\$ 6,663	



	MODEL NUMBER	PRODUCT	W	D	H	WEIGHT	VOLUME	LIST PRICE	DESCRIPTION
	BA-PAC-1-V2S-29	1 Person PAC Table, V2 Shaker: Sitting Height	36"	36"	37"	130 Lbs.	12 Cu Ft	\$ 4,494	<p>WORK SURFACE: Tops are constructed of 1 1/4" thick 3-ply particleboard core. Top surface is laminated with a .050" thick high pressure plastic laminate sheet and bottom surface laminated with a backing sheet not less than .020" thick for balanced construction. Surrounding edges will be 1 1/4" thick x 2 1/4" wide solid external hardwood knife profile with 1/2" rounded point and shall be mitered and radiused at corners.</p> <p>SUPERSTRUCTURE: Side panels constructed of 3/4" thick x 8" high solid hardwood and back panels constructed of 3/4" x 7 3/4" high veneer plywood core, top edge banded with 1/4" external hardwood.</p> <p>END PANELS: Panel frame construction consists of a 1 1/16" thick 3-ply particleboard core with plain sliced veneer both faces, two 1 1/2" thick x 2 5/8" wide solid hardwood sides, 1 1/2" thick x 3 1/2" top member and a 1 1/2" thick x 5" wide bottom with a 2 1/2" arched center. Center frame will be fitted with one horizontal 1/2" thick x 2" wide stile member, creating a double stacked rectangle motif design. All edges of panel frame are eased.</p> <p>ELECTRICAL ACCESSORIES: Each seating position shall receive a 3" diameter black plastic grommet and a black metal j-channel for wire management.</p>
	BA-PAC-1-V2S-32	Wheelchair Accessible	36"	36"	40"	130 Lbs.	12 Cu Ft	\$ 4,538	
	BA-PAC-1-V2S-39	Standing Height	36"	36"	47"	135 Lbs.	12 Cu Ft	\$ 4,663	
	BA-PAC-2-V2S-29	2 Person PAC Table, V2 Shaker: Sitting Height	72"	36"	37"	200 Lbs.	23 Cu Ft	\$ 5,238	
	BA-PAC-2-V2S-32	Wheelchair Accessible	72"	36"	40"	200 Lbs.	23 Cu Ft	\$ 5,281	
	BA-PAC-2-V2S-39	Standing Height	72"	36"	47"	205 Lbs.	23 Cu Ft	\$ 5,431	
	BA-PAC-3-V2S-29	3 Person PAC Table, V2 Shaker: Sitting Height	90"	36"	37"	250 Lbs.	28 Cu Ft	\$ 5,800	
	BA-PAC-3-V2S-32	Wheelchair Accessible	90"	36"	40"	250 Lbs.	28 Cu Ft	\$ 5,850	
	BA-PAC-3-V2S-39	Standing Height	90"	36"	47"	260 Lbs.	28 Cu Ft	\$ 6,006	



	MODEL NUMBER	PRODUCT	W	D	H	WEIGHT	VOLUME	LIST PRICE	DESCRIPTION
	BA-PAC-1-V3A-29	1 Person PAC Table, V3 Acrylic: Sitting Height	36"	36"	37"	130 Lbs.	12 Cu Ft	\$ 4,925	<p>WORK SURFACE: Tops are constructed of 1 1/4" thick 3-ply particleboard core. Top surface is laminated with a .050" thick high pressure plastic laminate sheet and bottom surface laminated with a backing sheet not less than .020" thick for balanced construction. Surrounding edges will be 1 1/4" thick x 2 1/4" wide solid external hardwood knife profile with 1/2" rounded point and shall be mitered and radiused at corners.</p> <p>SUPERSTRUCTURE: Side panels constructed of 3/4" thick x 8" high solid hardwood and back panels constructed of 3/4" x 7 3/4" high veneer plywood core, top edge banded with 1/4" external hardwood.</p> <p>END PANELS: Panel frame construction consists of two 1 1/2" thick x 2 5/8" wide solid hardwood sides, 1 1/2" thick x 3 1/2" top member and a 1 1/2" thick x 5" wide bottom with a 2 1/2" arched center. Center frame will be fitted with one horizontal and one vertical 1 1/2" thick x 2" wide stile members, creating a three rectangular motif design. All spaces are then fitted with 3/8" thick frosted acrylic inserts. All edges of panel frame are eased.</p> <p>ELECTRICAL ACCESSORIES: Each seating position shall receive a 3" diameter black plastic grommet and a black metal j-channel for wire management.</p>
	BA-PAC-1-V3A-32	Wheelchair Accessible	36"	36"	40"	130 Lbs.	12 Cu Ft	\$ 5,013	
	BA-PAC-1-V3A-39	Standing Height	36"	36"	47"	135 Lbs.	12 Cu Ft	\$ 5,244	
	BA-PAC-2-V3A-29	2 Person PAC Table, V3 Acrylic: Sitting Height	72"	36"	37"	200 Lbs.	23 Cu Ft	\$ 5,669	
	BA-PAC-2-V3A-32	Wheelchair Accessible	72"	36"	40"	200 Lbs.	23 Cu Ft	\$ 5,763	
	BA-PAC-2-V3A-39	Standing Height	72"	36"	47"	205 Lbs.	23 Cu Ft	\$ 6,013	
	BA-PAC-3-V3A-29	3 Person PAC Table, V3 Acrylic: Sitting Height	90"	36"	37"	250 Lbs.	28 Cu Ft	\$ 6,238	
	BA-PAC-3-V3A-32	Wheelchair Accessible	90"	36"	40"	250 Lbs.	28 Cu Ft	\$ 6,325	
	BA-PAC-3-V3A-39	Standing Height	90"	36"	47"	260 Lbs.	28 Cu Ft	\$ 6,588	



	MODEL NUMBER	PRODUCT	W	D	H	WEIGHT	VOLUME	LIST PRICE	DESCRIPTION
	BA-PAC-1-V3M-29	1 Person PAC Table, V3 Molding: Sitting Height	36"	36"	37"	130 Lbs.	12 Cu Ft	\$ 5,425	<p>WORK SURFACE: Tops are constructed of 1 1/4" thick 3-ply particleboard core. Top surface is laminated with a .050" thick high pressure plastic laminate sheet and bottom surface laminated with a backing sheet not less than .020" thick for balanced construction. Surrounding edges will be 1 1/4" thick x 2 1/4" wide solid external hardwood knife profile with 1/2" rounded point and shall be mitered and radiused at corners.</p> <p>SUPERSTRUCTURE: Side panels constructed of 3/4" thick x 8" high solid hardwood and back panels constructed of 3/4" x 7 3/4" high veneer plywood core, top edge banded with 1/4" external hardwood.</p> <p>END PANELS: Panel frame construction consists of a 1 1/16" thick 3-ply particleboard core with plain sliced veneer both faces, two 1 1/2" thick x 2 5/8" wide solid hardwood sides, 1 1/2" thick x 3 1/2" top member and a 1 1/2" thick x 5" wide bottom with a 2 1/2" arched center. Center frame will be fitted with one horizontal and one vertical 1/2" thick x 2" wide stile members, creating a three rectangular motif design. All spaces are then miter framed with 7/16" thick x 3/4" wide angled solid hardwood trim creating a raised frame effect. All edges of panel frame and trim are eased.</p> <p>ELECTRICAL ACCESSORIES: Each seating position shall receive a 3" diameter black plastic grommet and a black metal j-channel for wire management.</p>
	BA-PAC-1-V3M-32	Wheelchair Accessible	36"	36"	40"	130 Lbs.	12 Cu Ft	\$ 5,519	
	BA-PAC-1-V3M-39	Standing Height	36"	36"	47"	135 Lbs.	12 Cu Ft	\$ 5,756	
	BA-PAC-2-V3M-29	2 Person PAC Table, V3 Molding: Sitting Height	72"	36"	37"	200 Lbs.	23 Cu Ft	\$ 6,169	
	BA-PAC-2-V3M-32	Wheelchair Accessible	72"	36"	40"	200 Lbs.	23 Cu Ft	\$ 6,263	
	BA-PAC-2-V3M-39	Standing Height	72"	36"	47"	205 Lbs.	23 Cu Ft	\$ 6,531	
	BA-PAC-3-V3M-29	3 Person PAC Table, V3 Molding: Sitting Height	90"	36"	37"	250 Lbs.	28 Cu Ft	\$ 6,731	
	BA-PAC-3-V3M-32	Wheelchair Accessible	90"	36"	40"	250 Lbs.	28 Cu Ft	\$ 6,831	
	BA-PAC-3-V3M-39	Standing Height	90"	36"	47"	260 Lbs.	28 Cu Ft	\$ 7,106	



	MODEL NUMBER	PRODUCT	W	D	H	WEIGHT	VOLUME	LIST PRICE	DESCRIPTION
	BA-PAC-1-V2S-29	1 Person PAC Table, V3 Shaker: Sitting Height	36"	36"	37"	130 Lbs.	12 Cu Ft	\$ 4,706	<p>WORK SURFACE: Tops are constructed of 1 1/4" thick 3-ply particleboard core. Top surface is laminated with a .050" thick high pressure plastic laminate sheet and bottom surface laminated with a backing sheet not less than .020" thick for balanced construction. Surrounding edges will be 1 1/4" thick x 2 1/4" wide solid external hardwood knife profile with 1/2" rounded point and shall be mitered and radiused at corners.</p> <p>SUPERSTRUCTURE: Side panels constructed of 3/4" thick x 8" high solid hardwood and back panels constructed of 3/4" x 7 3/4" high veneer plywood core, top edge banded with 1/4" external hardwood.</p> <p>END PANELS: Panel frame construction consists of a 1 1/16" thick 3-ply particleboard core with plain sliced veneer both faces, two 1 1/2" thick x 2 5/8" wide solid hardwood sides, 1 1/2" thick x 3 1/2" top member and a 1 1/2" thick x 5" wide bottom with a 2 1/2" arched center. Center frame will be fitted with one horizontal and one vertical 1/2" thick x 2" wide stile members, creating a three rectangular motif design. All edges of panel frame are eased.</p> <p>ELECTRICAL ACCESSORIES: Each seating position shall receive a 3" diameter black plastic grommet and a black metal j-channel for wire management.</p>
	BA-PAC-1-V2S-32	Wheelchair Accessible	36"	36"	40"	130 Lbs.	12 Cu Ft	\$ 4,756	
	BA-PAC-1-V2S-39	Standing Height	36"	36"	47"	135 Lbs.	12 Cu Ft	\$ 4,900	
	BA-PAC-2-V2S-29	2 Person PAC Table, V3 Shaker: Sitting Height	72"	36"	37"	200 Lbs.	23 Cu Ft	\$ 5,450	
	BA-PAC-2-V2S-32	Wheelchair Accessible	72"	36"	40"	200 Lbs.	23 Cu Ft	\$ 5,506	
	BA-PAC-2-V2S-39	Standing Height	72"	36"	47"	205 Lbs.	23 Cu Ft	\$ 5,669	
	BA-PAC-3-V2S-29	3 Person PAC Table, V3 Shaker: Sitting Height	90"	36"	37"	250 Lbs.	28 Cu Ft	\$ 6,019	
	BA-PAC-3-V2S-32	Wheelchair Accessible	90"	36"	40"	250 Lbs.	28 Cu Ft	\$ 6,069	
	BA-PAC-3-V2S-39	Standing Height	90"	36"	47"	260 Lbs.	28 Cu Ft	\$ 6,244	



	MODEL NUMBER	PRODUCT	W	D	H	WEIGHT	VOLUME	LIST PRICE	DESCRIPTION
	BA-PAC-1-V4A-29	1 Person PAC Table, V4 Acrylic: Sitting Height	36"	36"	37"	130 Lbs.	12 Cu Ft	\$ 4,925	<p>WORK SURFACE: Tops are constructed of 1 1/4" thick 3-ply particleboard core. Top surface is laminated with a .050" thick high pressure plastic laminate sheet and bottom surface laminated with a backing sheet not less than .020" thick for balanced construction. Surrounding edges will be 1 1/4" thick x 2 1/4" wide solid external hardwood knife profile with 1/2" rounded point and shall be mitered and radiused at corners.</p> <p>SUPERSTRUCTURE: Side panels constructed of 3/4" thick x 8" high solid hardwood and back panels constructed of 3/4" x 7 3/4" high veneer plywood core, top edge banded with 1/4" external hardwood.</p> <p>END PANELS: Panel frame construction consists of two 1 1/2" thick x 2 5/8" wide solid hardwood sides, 1 1/2" thick x 3 1/2" top member and a 1 1/2" thick x 5" wide bottom with a 2 1/2" arched center. Center frame will be fitted with one horizontal and one vertical 1 1/2" thick x 2" wide stile members, creating a rectangle and square motif design. All spaces are then fitted with 3/8" thick frosted acrylic inserts. All edges of panel frame are eased.</p> <p>ELECTRICAL ACCESSORIES: Each seating position shall receive a 3" diameter black plastic grommet and a black metal j-channel for wire management.</p>
	BA-PAC-1-V4A-32	Wheelchair Accessible	36"	36"	40"	130 Lbs.	12 Cu Ft	\$ 5,013	
	BA-PAC-1-V4A-39	Standing Height	36"	36"	47"	135 Lbs.	12 Cu Ft	\$ 5,244	
	BA-PAC-2-V4A-29	2 Person PAC Table, V4 Acrylic: Sitting Height	72"	36"	37"	200 Lbs.	23 Cu Ft	\$ 5,669	
	BA-PAC-2-V4A-32	Wheelchair Accessible	72"	36"	40"	200 Lbs.	23 Cu Ft	\$ 5,763	
	BA-PAC-2-V4A-39	Standing Height	72"	36"	47"	205 Lbs.	23 Cu Ft	\$ 6,013	
	BA-PAC-3-V4A-29	3 Person PAC Table, V4 Acrylic: Sitting Height	90"	36"	37"	250 Lbs.	28 Cu Ft	\$ 6,238	
	BA-PAC-3-V4A-32	Wheelchair Accessible	90"	36"	40"	250 Lbs.	28 Cu Ft	\$ 6,325	
	BA-PAC-3-V4A-39	Standing Height	90"	36"	47"	260 Lbs.	28 Cu Ft	\$ 6,588	



	MODEL NUMBER	PRODUCT	W	D	H	WEIGHT	VOLUME	LIST PRICE	DESCRIPTION
	BA-PAC-1-V4M-29	1 Person PAC Table, V4 Molding: Sitting Height	36"	36"	37"	130 Lbs.	12 Cu Ft	\$ 5,425	<p>WORK SURFACE: Tops are constructed of 1 1/4" thick 3-ply particleboard core. Top surface is laminated with a .050" thick high pressure plastic laminate sheet and bottom surface laminated with a backing sheet not less than .020" thick for balanced construction. Surrounding edges will be 1 1/4" thick x 2 1/4" wide solid external hardwood knife profile with 1/2" rounded point and shall be mitered and radiused at corners.</p> <p>SUPERSTRUCTURE: Side panels constructed of 3/4" thick x 8" high solid hardwood and back panels constructed of 3/4" x 7 3/4" high veneer plywood core, top edge banded with 1/4" external hardwood.</p> <p>END PANELS: Panel frame construction consists of a 1 1/16" thick 3-ply particleboard core with plain sliced veneer both faces, two 1 1/2" thick x 2 5/8" wide solid hardwood sides, 1 1/2" thick x 3 1/2" top member and a 1 1/2" thick x 5" wide bottom with a 2 1/2" arched center. Center frame will be fitted with one horizontal and one vertical 1/2" thick x 2" wide stile members, creating a rectangle and square motif design. All spaces are then miter framed with 7/16" thick x 3/4" wide angled solid hardwood trim creating a raised frame effect. All edges of panel frame and trim are eased.</p> <p>ELECTRICAL ACCESSORIES: Each seating position shall receive a 3" diameter black plastic grommet and a black metal j-channel for wire management.</p>
	BA-PAC-1-V4M-32	Wheelchair Accessible	36"	36"	40"	130 Lbs.	12 Cu Ft	\$ 5,519	
	BA-PAC-1-V4M-39	Standing Height	36"	36"	47"	135 Lbs.	12 Cu Ft	\$ 5,756	
	BA-PAC-2-V4M-29	2 Person PAC Table, V4 Molding: Sitting Height	72"	36"	37"	200 Lbs.	23 Cu Ft	\$ 6,169	
	BA-PAC-2-V4M-32	Wheelchair Accessible	72"	36"	40"	200 Lbs.	23 Cu Ft	\$ 6,263	
	BA-PAC-2-V4M-39	Standing Height	72"	36"	47"	205 Lbs.	23 Cu Ft	\$ 6,531	
	BA-PAC-3-V4M-29	3 Person PAC Table, V4 Molding: Sitting Height	90"	36"	37"	250 Lbs.	28 Cu Ft	\$ 6,731	
	BA-PAC-3-V4M-32	Wheelchair Accessible	90"	36"	40"	250 Lbs.	28 Cu Ft	\$ 6,831	
	BA-PAC-3-V4M-39	Standing Height	90"	36"	47"	260 Lbs.	28 Cu Ft	\$ 7,106	



	MODEL NUMBER	PRODUCT	W	D	H	WEIGHT	VOLUME	LIST PRICE	DESCRIPTION
	BA-PAC-1-V4S-29	1 Person PAC Table, V4 Shaker: Sitting Height	36"	36"	37"	130 Lbs.	12 Cu Ft	\$ 4,706	<p>WORK SURFACE: Tops are constructed of 1 1/4" thick 3-ply particleboard core. Top surface is laminated with a .050" thick high pressure plastic laminate sheet and bottom surface laminated with a backing sheet not less than .020" thick for balanced construction. Surrounding edges will be 1 1/4" thick x 2 1/4" wide solid external hardwood knife profile with 1/2" rounded point and shall be mitered and radiused at corners.</p> <p>SUPERSTRUCTURE: Side panels constructed of 3/4" thick x 8" high solid hardwood and back panels constructed of 3/4" x 7 3/4" high veneer plywood core, top edge banded with 1/4" external hardwood.</p> <p>END PANELS: Panel frame construction consists of a 1 1/16" thick 3-ply particleboard core with plain sliced veneer both faces, two 1 1/2" thick x 2 5/8" wide solid hardwood sides, 1 1/2" thick x 3 1/2" top member and a 1 1/2" thick x 5" wide bottom with a 2 1/2" arched center. Center frame will be fitted with one horizontal and one vertical 1/2" thick x 2" wide stile members, creating a rectangle and square motif design. All edges of panel frame are eased.</p> <p>ELECTRICAL ACCESSORIES: Each seating position shall receive a 3" diameter black plastic grommet and a black metal j-channel for wire management.</p>
	BA-PAC-1-V4S-32	Wheelchair Accessible	36"	36"	40"	130 Lbs.	12 Cu Ft	\$ 4,756	
	BA-PAC-1-V4S-39	Standing Height	36"	36"	47"	135 Lbs.	12 Cu Ft	\$ 4,900	
	BA-PAC-2-V4S-29	2 Person PAC Table, V4 Shaker: Sitting Height	72"	36"	37"	200 Lbs.	23 Cu Ft	\$ 5,450	
	BA-PAC-2-V4S-32	Wheelchair Accessible	72"	36"	40"	200 Lbs.	23 Cu Ft	\$ 5,506	
	BA-PAC-2-V4S-39	Standing Height	72"	36"	47"	205 Lbs.	23 Cu Ft	\$ 5,669	
	BA-PAC-3-V4S-29	3 Person PAC Table, V4 Shaker: Sitting Height	90"	36"	37"	250 Lbs.	28 Cu Ft	\$ 6,019	
	BA-PAC-3-V4S-32	Wheelchair Accessible	90"	36"	40"	250 Lbs.	28 Cu Ft	\$ 6,069	
	BA-PAC-3-V4S-39	Standing Height	90"	36"	47"	260 Lbs.	28 Cu Ft	\$ 6,244	



	MODEL NUMBER	PRODUCT	W	D	H	WEIGHT	VOLUME	LIST PRICE	DESCRIPTION
	BA-PAC-1-V5A-29	1 Person PAC Table, V5 Acrylic: Sitting Height	36"	36"	37"	130 Lbs.	12 Cu Ft	\$ 4,975	<p>WORK SURFACE: Tops are constructed of 1 1/4" thick 3-ply particleboard core. Top surface is laminated with a .050" thick high pressure plastic laminate sheet and bottom surface laminated with a backing sheet not less than .020" thick for balanced construction. Surrounding edges will be 1 1/4" thick x 2 1/4" wide solid external hardwood knife profile with 1/2" rounded point and shall be mitered and radiused at corners.</p> <p>SUPERSTRUCTURE: Side panels constructed of 3/4" thick x 8" high solid hardwood and back panels constructed of 3/4" x 7 3/4" high veneer plywood core, top edge banded with 1/4" external hardwood.</p> <p>END PANELS: Panel frame construction consists of two 1 1/2" thick x 2 5/8" wide solid hardwood sides, 1 1/2" thick x 3 1/2" top member and a 1 1/2" thick x 5" wide bottom with a 2 1/2" arched center. Center frame will be fitted with one horizontal and one vertical 1 1/2" thick x 2" wide stile members, creating a four rectangular motif design. All spaces are then fitted with 3/8" thick frosted acrylic inserts. All edges of panel frame are eased.</p> <p>ELECTRICAL ACCESSORIES: Each seating position shall receive a 3" diameter black plastic grommet and a black metal j-channel for wire management.</p>
	BA-PAC-1-V5A-32	Wheelchair Accessible	36"	36"	40"	130 Lbs.	12 Cu Ft	\$ 5,081	
	BA-PAC-1-V5A-39	Standing Height	36"	36"	47"	135 Lbs.	12 Cu Ft	\$ 5,344	
	BA-PAC-2-V5A-29	2 Person PAC Table, V5 Acrylic: Sitting Height	72"	36"	37"	200 Lbs.	23 Cu Ft	\$ 5,725	
	BA-PAC-2-V5A-32	Wheelchair Accessible	72"	36"	40"	200 Lbs.	23 Cu Ft	\$ 5,825	
	BA-PAC-2-V5A-39	Standing Height	72"	36"	47"	205 Lbs.	23 Cu Ft	\$ 6,113	
	BA-PAC-3-V5A-29	3 Person PAC Table, V5 Acrylic: Sitting Height	90"	36"	37"	250 Lbs.	28 Cu Ft	\$ 6,288	
	BA-PAC-3-V5A-32	Wheelchair Accessible	90"	36"	40"	250 Lbs.	28 Cu Ft	\$ 6,394	
	BA-PAC-3-V5A-39	Standing Height	90"	36"	47"	260 Lbs.	28 Cu Ft	\$ 6,688	

	MODEL NUMBER	PRODUCT	W	D	H	WEIGHT	VOLUME	LIST PRICE	DESCRIPTION
	BA-PAC-1-V5M-29	1 Person PAC Table, V5 Molding: Sitting Height	36"	36"	37"	130 Lbs.	12 Cu Ft	\$ 5,531	<p>WORK SURFACE: Tops are constructed of 1 1/4" thick 3-ply particleboard core. Top surface is laminated with a .050" thick high pressure plastic laminate sheet and bottom surface laminated with a backing sheet not less than .020" thick for balanced construction. Surrounding edges will be 1 1/4" thick x 2 1/4" wide solid external hardwood knife profile with 1/2" rounded point and shall be mitered and radiused at corners.</p> <p>SUPERSTRUCTURE: Side panels constructed of 3/4" thick x 8" high solid hardwood and back panels constructed of 3/4" x 7 3/4" high veneer plywood core, top edge banded with 1/4" external hardwood.</p> <p>END PANELS: Panel frame construction consists of a 1 1/16" thick 3-ply particleboard core with plain sliced veneer both faces, two 1 1/2" thick x 2 5/8" wide solid hardwood sides, 1 1/2" thick x 3 1/2" top member and a 1 1/2" thick x 5" wide bottom with a 2 1/2" arched center. Center frame will be fitted with one horizontal and one vertical 1/2" thick x 2" wide stile members, creating a four rectangular motif design. All spaces are then miter framed with 7/16" thick x 3/4" wide angled solid hardwood trim creating a raised frame effect. All edges of panel frame and trim are eased.</p> <p>ELECTRICAL ACCESSORIES: Each seating position shall receive a 3" diameter black plastic grommet and a black metal j-channel for wire management.</p>
	BA-PAC-1-V5M-32	Wheelchair Accessible	36"	36"	40"	130 Lbs.	12 Cu Ft	\$ 5,644	
	BA-PAC-1-V5M-39	Standing Height	36"	36"	47"	135 Lbs.	12 Cu Ft	\$ 5,938	
	BA-PAC-2-V5M-29	2 Person PAC Table, V5 Molding: Sitting Height	72"	36"	37"	200 Lbs.	23 Cu Ft	\$ 6,275	
	BA-PAC-2-V5M-32	Wheelchair Accessible	72"	36"	40"	200 Lbs.	23 Cu Ft	\$ 6,394	
	BA-PAC-2-V5M-39	Standing Height	72"	36"	47"	205 Lbs.	23 Cu Ft	\$ 6,706	
	BA-PAC-3-V5M-29	3 Person PAC Table, V5 Molding: Sitting Height	90"	36"	37"	250 Lbs.	28 Cu Ft	\$ 6,844	
	BA-PAC-3-V5M-32	Wheelchair Accessible	90"	36"	40"	250 Lbs.	28 Cu Ft	\$ 6,956	
	BA-PAC-3-V5M-39	Standing Height	90"	36"	47"	260 Lbs.	28 Cu Ft	\$ 7,288	



	MODEL NUMBER	PRODUCT	W	D	H	WEIGHT	VOLUME	LIST PRICE	DESCRIPTION
	BA-PAC-1-V5S-29	1 Person PAC Table, V5 Shaker: Sitting Height	36"	36"	37"	130 Lbs.	12 Cu Ft	\$ 4,738	<p>WORK SURFACE: Tops are constructed of 1 1/4" thick 3-ply particleboard core. Top surface is laminated with a .050" thick high pressure plastic laminate sheet and bottom surface laminated with a backing sheet not less than .020" thick for balanced construction. Surrounding edges will be 1 1/4" thick x 2 1/4" wide solid external hardwood knife profile with 1/2" rounded point and shall be mitered and radiused at corners.</p> <p>SUPERSTRUCTURE: Side panels constructed of 3/4" thick x 8" high solid hardwood and back panels constructed of 3/4" x 7 3/4" high veneer plywood core, top edge banded with 1/4" external hardwood.</p> <p>END PANELS: Panel frame construction consists of a 1 1/16" thick 3-ply particleboard core with plain sliced veneer both faces, two 1 1/2" thick x 2 5/8" wide solid hardwood sides, 1 1/2" thick x 3 1/2" top member and a 1 1/2" thick x 5" wide bottom with a 2 1/2" arched center. Center frame will be fitted with one horizontal and one vertical 1/2" thick x 2" wide stile members, creating a four rectangular motif design. All edges of panel frame are eased.</p> <p>ELECTRICAL ACCESSORIES: Each seating position shall receive a 3" diameter black plastic grommet and a black metal j-channel for wire management.</p>
	BA-PAC-1-V5S-32	Wheelchair Accessible	36"	36"	40"	130 Lbs.	12 Cu Ft	\$ 4,800	
	BA-PAC-1-V5S-39	Standing Height	36"	36"	47"	135 Lbs.	12 Cu Ft	\$ 4,956	
	BA-PAC-2-V5S-29	2 Person PAC Table, V5 Shaker: Sitting Height	72"	36"	37"	200 Lbs.	23 Cu Ft	\$ 5,488	
	BA-PAC-2-V5S-32	Wheelchair Accessible	72"	36"	40"	200 Lbs.	23 Cu Ft	\$ 5,550	
	BA-PAC-2-V5S-39	Standing Height	72"	36"	47"	205 Lbs.	23 Cu Ft	\$ 5,731	
	BA-PAC-3-V5S-29	3 Person PAC Table, V5 Shaker: Sitting Height	90"	36"	37"	250 Lbs.	28 Cu Ft	\$ 6,050	
	BA-PAC-3-V5S-32	Wheelchair Accessible	90"	36"	40"	250 Lbs.	28 Cu Ft	\$ 6,113	
	BA-PAC-3-V5S-39	Standing Height	90"	36"	47"	260 Lbs.	28 Cu Ft	\$ 6,306	



	MODEL NUMBER	PRODUCT	W	D	H	WEIGHT	VOLUME	LIST PRICE	DESCRIPTION
	BA-PAC-1-V6A-29	1 Person PAC Table, V6 Acrylic: Sitting Height	36"	36"	37"	130 Lbs.	12 Cu Ft	\$ 4,363	<p>WORK SURFACE: Tops are constructed of 1 1/4" thick 3-ply particleboard core. Top surface is laminated with a .050" thick high pressure plastic laminate sheet and bottom surface laminated with a backing sheet not less than .020" thick for balanced construction. Surrounding edges will be 1 1/4" thick x 2 1/4" wide solid external hardwood knife profile with 1/2" rounded point and shall be mitered and radiused at corners.</p> <p>SUPERSTRUCTURE: Side panels constructed of 3/4" thick x 8" high solid hardwood and back panels constructed of 3/4" x 7 3/4" high veneer plywood core, top edge banded with 1/4" external hardwood.</p> <p>END PANELS: Panel frame construction consists of two 1 1/2" thick x 2 5/8" wide solid hardwood sides, 1 1/2" thick x 3 1/2" top member and a 1 1/2" thick x 5" wide bottom with a 2 1/2" arched center. Center space is then fitted with 3/8" thick frosted acrylic inserts. All edges of panel frame are eased.</p> <p>ELECTRICAL ACCESSORIES: Each seating position shall receive a 3" diameter black plastic grommet and a black metal j-channel for wire management.</p>
	BA-PAC-1-V6A-32	Wheelchair Accessible	36"	36"	40"	130 Lbs.	12 Cu Ft	\$ 4,431	
	BA-PAC-1-V6A-39	Standing Height	36"	36"	47"	135 Lbs.	12 Cu Ft	\$ 4,606	
	BA-PAC-2-V6A-29	2 Person PAC Table, V6 Acrylic: Sitting Height	72"	36"	37"	200 Lbs.	23 Cu Ft	\$ 5,113	
	BA-PAC-2-V6A-32	Wheelchair Accessible	72"	36"	40"	200 Lbs.	23 Cu Ft	\$ 5,181	
	BA-PAC-2-V6A-39	Standing Height	72"	36"	47"	205 Lbs.	23 Cu Ft	\$ 5,381	
	BA-PAC-3-V6A-29	3 Person PAC Table, V6 Acrylic: Sitting Height	90"	36"	37"	250 Lbs.	28 Cu Ft	\$ 5,675	
	BA-PAC-3-V6A-32	Wheelchair Accessible	90"	36"	40"	250 Lbs.	28 Cu Ft	\$ 5,744	
	BA-PAC-3-V6A-39	Standing Height	90"	36"	47"	260 Lbs.	28 Cu Ft	\$ 5,956	







	MODEL NUMBER	PRODUCT	W	D	H	WEIGHT	VOLUME	LIST PRICE	DESCRIPTION
	BA-PAC-1-V6M-29	1 Person PAC Table, V6 Molding: Sitting Height	36"	36"	37"	130 Lbs.	12 Cu Ft	\$ 4,588	<p>WORK SURFACE: Tops are constructed of 1 1/4" thick 3-ply particleboard core. Top surface is laminated with a .050" thick high pressure plastic laminate sheet and bottom surface laminated with a backing sheet not less than .020" thick for balanced construction. Surrounding edges will be 1 1/4" thick x 2 1/4" wide solid external hardwood knife profile with 1/2" rounded point and shall be mitered and radiused at corners.</p> <p>SUPERSTRUCTURE: Side panels constructed of 3/4" thick x 8" high solid hardwood and back panels constructed of 3/4" x 7 3/4" high veneer plywood core, top edge banded with 1/4" external hardwood.</p> <p>END PANELS: Panel frame construction consists of a 1 1/16" thick 3-ply particleboard core with plain sliced veneer both faces, two 1 1/2" thick x 2 5/8" wide solid hardwood sides, 1 1/2" thick x 3 1/2" top member and a 1 1/2" thick x 5" wide bottom with a 2 1/2" arched center. Center space is then miter framed with 7/16" thick x 3/4" wide angled solid hardwood trim creating a raised frame effect. All edges of panel frame and trim are eased.</p> <p>ELECTRICAL ACCESSORIES: Each seating position shall receive a 3" diameter black plastic grommet and a black metal j-channel for wire management.</p>
	BA-PAC-1-V6M-32	Wheelchair Accessible	36"	36"	40"	130 Lbs.	12 Cu Ft	\$ 4,638	
	BA-PAC-1-V6M-39	Standing Height	36"	36"	47"	135 Lbs.	12 Cu Ft	\$ 4,781	
	BA-PAC-2-V6M-29	2 Person PAC Table, V6 Molding: Sitting Height	72"	36"	37"	200 Lbs.	23 Cu Ft	\$ 5,331	
	BA-PAC-2-V6M-32	Wheelchair Accessible	72"	36"	40"	200 Lbs.	23 Cu Ft	\$ 5,388	
	BA-PAC-2-V6M-39	Standing Height	72"	36"	47"	205 Lbs.	23 Cu Ft	\$ 5,550	
	BA-PAC-3-V6M-29	3 Person PAC Table, V6 Molding: Sitting Height	90"	36"	37"	250 Lbs.	28 Cu Ft	\$ 5,894	
	BA-PAC-3-V6M-32	Wheelchair Accessible	90"	36"	40"	250 Lbs.	28 Cu Ft	\$ 5,950	
	BA-PAC-3-V6M-39	Standing Height	90"	36"	47"	260 Lbs.	28 Cu Ft	\$ 6,125	



	MODEL NUMBER	PRODUCT	W	D	H	WEIGHT	VOLUME	LIST PRICE	DESCRIPTION
	BA-PAC-1-V6S-29	1 Person PAC Table, V6 Shaker: Sitting Height	36"	36"	37"	130 Lbs.	12 Cu Ft	\$ 4,219	<p>WORK SURFACE: Tops are constructed of 1 1/4" thick 3-ply particleboard core. Top surface is laminated with a .050" thick high pressure plastic laminate sheet and bottom surface laminated with a backing sheet not less than .020" thick for balanced construction. Surrounding edges will be 1 1/4" thick x 2 1/4" wide solid external hardwood knife profile with 1/2" rounded point and shall be mitered and radiused at corners.</p> <p>SUPERSTRUCTURE: Side panels constructed of 3/4" thick x 8" high solid hardwood and back panels constructed of 3/4" x 7 3/4" high veneer plywood core, top edge banded with 1/4" external hardwood.</p> <p>END PANELS: Panel frame construction consists of a 1 1/16" thick 3-ply particleboard core with plain sliced veneer both faces, two 1 1/2" thick x 2 5/8" wide solid hardwood sides, 1 1/2" thick x 3 1/2" top member and a 1 1/2" thick x 5" wide bottom with a 2 1/2" arched center. All edges of panel frame are eased.</p> <p>ELECTRICAL ACCESSORIES: Each seating position shall receive a 3" diameter black plastic grommet and a black metal j-channel for wire management.</p>
	BA-PAC-1-V6S-32	Wheelchair Accessible	36"	36"	40"	130 Lbs.	12 Cu Ft	\$ 4,256	
	BA-PAC-1-V6S-39	Standing Height	36"	36"	47"	135 Lbs.	12 Cu Ft	\$ 4,363	
	BA-PAC-2-V6S-29	2 Person PAC Table, V6 Shaker: Sitting Height	72"	36"	37"	200 Lbs.	23 Cu Ft	\$ 4,963	
	BA-PAC-2-V6S-32	Wheelchair Accessible	72"	36"	40"	200 Lbs.	23 Cu Ft	\$ 5,006	
	BA-PAC-2-V6S-39	Standing Height	72"	36"	47"	205 Lbs.	23 Cu Ft	\$ 5,138	
	BA-PAC-3-V6S-29	3 Person PAC Table, V6 Shaker: Sitting Height	90"	36"	37"	250 Lbs.	28 Cu Ft	\$ 5,531	
	BA-PAC-3-V6S-32	Wheelchair Accessible	90"	36"	40"	250 Lbs.	28 Cu Ft	\$ 5,569	
	BA-PAC-3-V6S-39	Standing Height	90"	36"	47"	260 Lbs.	28 Cu Ft	\$ 5,713	



	MODEL NUMBER	PRODUCT	W	D	H	WEIGHT	VOLUME	LIST PRICE	DESCRIPTION
	BA-R36	Round Reading Table	36" Dia.		29"	70 Lbs.	4 Cu Ft	\$ 2,538	<p>WORK SURFACE: Tops are constructed of 1 1/4" thick 3-ply particleboard core. Top surface is laminated with a .050" thick high pressure plastic laminate sheet and bottom surface laminated with a backing sheet not less than .020" thick for balanced construction. Surrounding edges will be 1 1/4" thick x 2 1/4" wide solid external hardwood knife profile with 1/2" rounded point and shall be mitered and radiused at corners.</p> <p>APRON: Apron rails for circular and square tables are 3/4" thick x 3 3/8" wide solid hardwood and mechanically fastened between legs.</p> <p>WORK SURFACE HEIGHT: Table heights of 25" (children), 27" (youth), and 32" (wheelchair) are available by request.</p>
	BA-R42		42" Dia.		29"	90 Lbs.	5 Cu Ft	\$ 2,806	
	BA-R48		48" Dia.		29"	100 Lbs.	6 Cu Ft	\$ 2,975	
	BA-3636	Square Reading Table	36"	36"	29"	70 Lbs.	4 Cu Ft	\$ 2,875	
	BA-4242		42"	42"	29"	90 Lbs.	6 Cu Ft	\$ 3,188	
	BA-4848		48"	48"	29"	100 Lbs.	6 Cu Ft	\$ 3,331	



	MODEL NUMBER	PRODUCT	W	D	H	WEIGHT	VOLUME	LIST PRICE	DESCRIPTION
	BA-V1A-6036	Rectangle Reading Table Version 1A – Acrylic	60"	36"	29"	175 Lbs.	9 Cu Ft	\$ 5,194	<p>WORK SURFACE: Tops are constructed of 1 1/4" thick 3-ply particleboard core. Top surface is laminated with a .050" thick high pressure plastic laminate sheet and bottom surface laminated with a backing sheet not less than .020" thick for balanced construction. Surrounding edges will be 1 1/4" thick x 2 1/4" wide solid external hardwood knife profile with 1/2" rounded point and shall be mitered and radiused at corners.</p> <p>END PANELS: Version 1A: Panel frame construction consists of two 1 1/2" thick x 2 5/8" wide solid hardwood sides, 1 1/2" thick x 3 1/2" top member and a 1 1/2" thick x 5" wide bottom with a 2 1/2" arched center. Center frame will be fitted with one horizontal and three vertical 1 1/2" thick x 2" wide stile members, creating a rectangle and square motif design. All spaces are then fitted with 3/8" thick frosted acrylic inserts. All edges of panel frame are eased.</p> <p>Version 1M: Panel frame construction consists of a 1 1/16" thick 3-ply particleboard core with plain sliced veneer both faces, two 1 1/2" thick x 2 5/8" wide solid hardwood sides, 1 1/2" thick x 3 1/2" top member and a 1 1/2" thick x 5" wide bottom with a 2 1/2" arched center. Center frame will be fitted with one horizontal and three vertical 1 1/2" thick x 2" wide stile members, creating a rectangle and square motif design. All spaces are then miter framed with 7/16" thick x 3/4" wide angled solid hardwood trim creating a raised frame effect. All edges of panel frame and trim are eased.</p> <p>Version 1S: Panel frame construction consists of a 1 1/16" thick 3-ply particleboard core with plain sliced veneer both faces, two 1 1/2" thick x 2 5/8" wide solid hardwood sides, 1 1/2" thick x 3 1/2" top member and a 1 1/2" thick x 5" wide bottom with a 2 1/2" arched center. Center frame will be fitted with one horizontal and three vertical 1 1/2" thick x 2" wide stile members, creating a rectangle and square motif design. All edges of panel frame are eased.</p>
	BA-V1A-6042		60"	42"	29"	160 Lbs.	7 Cu Ft	\$ 5,406	
	BA-V1A-6048		60"	48"	29"	230 Lbs.	9 Cu Ft	\$ 5,619	
	BA-V1A-7236	72"	36"	29"	190 Lbs.	8 Cu Ft	\$ 5,413		
	BA-V1A-7242	72"	42"	29"	215 Lbs.	10 Cu Ft	\$ 5,631		
	BA-V1A-7248	72"	48"	29"	230 Lbs.	10 Cu Ft	\$ 5,856		
	BA-V1A-8436	84"	36"	29"	230 Lbs.	8 Cu Ft	\$ 5,631		
	BA-V1A-8442	84"	42"	29"	245 Lbs.	9 Cu Ft	\$ 5,863		
	BA-V1A-8448	84"	48"	29"	290 Lbs.	10 Cu Ft	\$ 6,088		
BA-V1A-9636	96"	36"	29"	290 Lbs.	10 Cu Ft	\$ 5,850			
BA-V1A-9642	96"	42"	29"	310 Lbs.	12 Cu Ft	\$ 6,088			
BA-V1A-9648	96"	48"	29"	320 Lbs.	12 Cu Ft	\$ 6,325			
	BA-V1M-6036	Rectangle Reading Table Version 1M – Molding	60"	36"	29"	175 Lbs.	9 Cu Ft	\$ 5,425	
	BA-V1M-6042		60"	42"	29"	160 Lbs.	7 Cu Ft	\$ 5,650	
	BA-V1M-6048		60"	48"	29"	230 Lbs.	9 Cu Ft	\$ 6,231	
	BA-V1M-7236	72"	36"	29"	190 Lbs.	8 Cu Ft	\$ 5,644		
	BA-V1M-7242	72"	42"	29"	215 Lbs.	10 Cu Ft	\$ 5,881		
	BA-V1M-7248	72"	48"	29"	230 Lbs.	10 Cu Ft	\$ 6,469		
	BA-V1M-8436	84"	36"	29"	230 Lbs.	8 Cu Ft	\$ 5,863		
	BA-V1M-8442	84"	42"	29"	245 Lbs.	9 Cu Ft	\$ 6,106		
	BA-V1M-8448	84"	48"	29"	290 Lbs.	10 Cu Ft	\$ 6,700		
BA-V1M-9636	96"	36"	29"	290 Lbs.	10 Cu Ft	\$ 6,081			
BA-V1M-9642	96"	42"	29"	310 Lbs.	12 Cu Ft	\$ 6,331			
BA-V1M-9648	96"	48"	29"	320 Lbs.	12 Cu Ft	\$ 6,938			
	BA-V1S-6036	Rectangle Reading Table Version 1S – Shaker	60"	36"	29"	175 Lbs.	9 Cu Ft	\$ 4,981	
	BA-V1S-6042		60"	42"	29"	160 Lbs.	7 Cu Ft	\$ 5,144	
	BA-V1S-6048		60"	48"	29"	230 Lbs.	9 Cu Ft	\$ 5,313	
	BA-V1S-7236	72"	36"	29"	190 Lbs.	8 Cu Ft	\$ 5,194		
	BA-V1S-7242	72"	42"	29"	215 Lbs.	10 Cu Ft	\$ 5,375		
	BA-V1S-7248	72"	48"	29"	230 Lbs.	10 Cu Ft	\$ 5,550		
	BA-V1S-8436	84"	36"	29"	230 Lbs.	8 Cu Ft	\$ 5,413		
	BA-V1S-8442	84"	42"	29"	245 Lbs.	9 Cu Ft	\$ 5,600		
	BA-V1S-8448	84"	48"	29"	290 Lbs.	10 Cu Ft	\$ 5,781		
BA-V1S-9636	96"	36"	29"	290 Lbs.	10 Cu Ft	\$ 5,631			
BA-V1S-9642	96"	42"	29"	310 Lbs.	12 Cu Ft	\$ 5,825			
BA-V1S-9648	96"	48"	29"	320 Lbs.	12 Cu Ft	\$ 6,019			

	MODEL NUMBER	PRODUCT	W	D	H	WEIGHT	VOLUME	LIST PRICE	DESCRIPTION
	BA-V2A-6036	Rectangle Reading Table Version 2A – Acrylic	60"	36"	29"	175 Lbs.	9 Cu Ft	\$ 4,788	<p>WORK SURFACE: Tops are constructed of 1 1/4" thick 3-ply particleboard core. Top surface is laminated with a .050" thick high pressure plastic laminate sheet and bottom surface laminated with a backing sheet not less than .020" thick for balanced construction. Surrounding edges will be 1 1/4" thick x 2 1/4" wide solid external hardwood knife profile with 1/2" rounded point and shall be mitered and radiused at corners.</p> <p>END PANELS: Version 2A: Panel frame construction consists of two 1 1/2" thick x 2 5/8" wide solid hardwood sides, 1 1/2" thick x 3 1/2" top member and a 1 1/2" thick x 5" wide bottom with a 2 1/2" arched center. Center frame will be fitted with one horizontal and one vertical 1 1/2" thick x 2" wide stile members, creating a four rectangular motif design. All spaces are then fitted with 3/8" thick frosted acrylic inserts. All edges of panel frame are eased.</p> <p>Version 2M: Panel frame construction consists of a 1 1/16" thick 3-ply particleboard core with plain sliced veneer both faces, two 1 1/2" thick x 2 5/8" wide solid hardwood sides, 1 1/2" thick x 3 1/2" top member and a 1 1/2" thick x 5" wide bottom with a 2 1/2" arched center. Center frame will be fitted with one horizontal and one vertical 1/2" thick x 2" wide stile members, creating a four rectangular motif design. All spaces are then miter framed with 7/16" thick x 3/4" wide angled solid hardwood trim creating a raised frame effect. All edges of panel frame and trim are eased.</p> <p>Version 2S: Panel frame construction consists of a 1 1/16" thick 3-ply particleboard core with plain sliced veneer both faces, two 1 1/2" thick x 2 5/8" wide solid hardwood sides, 1 1/2" thick x 3 1/2" top member and a 1 1/2" thick x 5" wide bottom with a 2 1/2" arched center. Center frame will be fitted with one horizontal and one vertical 1/2" thick x 2" wide stile members, creating a four rectangular motif design. All edges of panel frame are eased.</p>
	BA-V2A-6042		60"	42"	29"	160 Lbs.	7 Cu Ft	\$ 4,994	
	BA-V2A-6048		60"	48"	29"	230 Lbs.	9 Cu Ft	\$ 5,206	
	BA-V2A-7236	72"	36"	29"	190 Lbs.	8 Cu Ft	\$ 5,000		
	BA-V2A-7242	72"	42"	29"	215 Lbs.	10 Cu Ft	\$ 5,225		
	BA-V2A-7248	72"	48"	29"	230 Lbs.	10 Cu Ft	\$ 5,444		
	BA-V2A-8436	84"	36"	29"	230 Lbs.	8 Cu Ft	\$ 5,219		
	BA-V2A-8442	84"	42"	29"	245 Lbs.	9 Cu Ft	\$ 5,450		
	BA-V2A-8448	84"	48"	29"	290 Lbs.	10 Cu Ft	\$ 5,675		
BA-V2A-9636	96"	36"	29"	290 Lbs.	10 Cu Ft	\$ 5,438			
BA-V2A-9642	96"	42"	29"	310 Lbs.	12 Cu Ft	\$ 5,675			
BA-V2A-9648	96"	48"	29"	320 Lbs.	12 Cu Ft	\$ 5,913			
	BA-V2M-6036	Rectangle Reading Table Version 2M – Molding	60"	36"	29"	175 Lbs.	9 Cu Ft	\$ 4,963	
	BA-V2M-6042		60"	42"	29"	160 Lbs.	7 Cu Ft	\$ 5,188	
	BA-V2M-6048		60"	48"	29"	230 Lbs.	9 Cu Ft	\$ 5,413	
	BA-V2M-7236	72"	36"	29"	190 Lbs.	8 Cu Ft	\$ 5,181		
	BA-V2M-7242	72"	42"	29"	215 Lbs.	10 Cu Ft	\$ 5,413		
	BA-V2M-7248	72"	48"	29"	230 Lbs.	10 Cu Ft	\$ 5,650		
	BA-V2M-8436	84"	36"	29"	230 Lbs.	8 Cu Ft	\$ 5,400		
	BA-V2M-8442	84"	42"	29"	245 Lbs.	9 Cu Ft	\$ 5,644		
	BA-V2M-8448	84"	48"	29"	290 Lbs.	10 Cu Ft	\$ 5,881		
BA-V2M-9636	96"	36"	29"	290 Lbs.	10 Cu Ft	\$ 5,619			
BA-V2M-9642	96"	42"	29"	310 Lbs.	12 Cu Ft	\$ 5,869			
BA-V2M-9648	96"	48"	29"	320 Lbs.	12 Cu Ft	\$ 6,119			
	BA-V2S-6036	Rectangle Reading Table Version 2S – Shaker	60"	36"	29"	175 Lbs.	9 Cu Ft	\$ 4,588	
	BA-V2S-6042		60"	42"	29"	160 Lbs.	7 Cu Ft	\$ 4,750	
	BA-V2S-6048		60"	48"	29"	230 Lbs.	9 Cu Ft	\$ 4,925	
	BA-V2S-7236	72"	36"	29"	190 Lbs.	8 Cu Ft	\$ 4,806		
	BA-V2S-7242	72"	42"	29"	215 Lbs.	10 Cu Ft	\$ 4,981		
	BA-V2S-7248	72"	48"	29"	230 Lbs.	10 Cu Ft	\$ 5,156		
	BA-V2S-8436	84"	36"	29"	230 Lbs.	8 Cu Ft	\$ 5,025		
	BA-V2S-8442	84"	42"	29"	245 Lbs.	9 Cu Ft	\$ 5,206		
	BA-V2S-8448	84"	48"	29"	290 Lbs.	10 Cu Ft	\$ 5,394		
BA-V2S-9636	96"	36"	29"	290 Lbs.	10 Cu Ft	\$ 5,238			
BA-V2S-9642	96"	42"	29"	310 Lbs.	12 Cu Ft	\$ 5,431			
BA-V2S-9648	96"	48"	29"	320 Lbs.	12 Cu Ft	\$ 5,625			

	MODEL NUMBER	PRODUCT	W	D	H	WEIGHT	VOLUME	LIST PRICE	DESCRIPTION
	BA-V3A-6036	Rectangle Reading Table Version 3A – Acrylic	60"	36"	29"	175 Lbs.	9 Cu Ft	\$ 5,194	WORK SURFACE: Tops are constructed of 1 1/4" thick 3-ply particleboard core. Top surface is laminated with a .050" thick high pressure plastic laminate sheet and bottom surface laminated with a backing sheet not less than .020" thick for balanced construction. Surrounding edges will be 1 1/4" thick x 2 1/4" wide solid external hardwood knife profile with 1/2" rounded point and shall be mitered and radiused at corners. END PANELS: Version 3A: Panel frame construction consists of two 1 1/2" thick x 2 5/8" wide solid hardwood sides, 1 1/2" thick x 3 1/2" top member and a 1 1/2" thick x 5" wide bottom with a 2 1/2" arched center. Center frame will be fitted with two horizontal and two vertical 1 1/2" thick x 2" wide stile members, creating a five rectangular motif design. All spaces are then fitted with 3/8" thick frosted acrylic inserts. All edges of panel frame are eased. Version 3M: Panel frame construction consists of a 1 1/16" thick 3-ply particleboard core with plain sliced veneer both faces, two 1 1/2" thick x 2 5/8" wide solid hardwood sides, 1 1/2" thick x 3 1/2" top member and a 1 1/2" thick x 5" wide bottom with a 2 1/2" arched center. Center frame will be fitted with two horizontal and two vertical 1/2" thick x 2" wide stile members, creating a five rectangular motif design. All spaces are then miter framed with 7/16" thick x 3/4" wide angled solid hardwood trim creating a raised frame effect. All edges of panel frame and trim are eased. Version 3S: Panel frame construction consists of a 1 1/16" thick 3-ply particleboard core with plain sliced veneer both faces, two 1 1/2" thick x 2 5/8" wide solid hardwood sides, 1 1/2" thick x 3 1/2" top member and a 1 1/2" thick x 5" wide bottom with a 2 1/2" arched center. Center frame will be fitted with two horizontal and two vertical 1/2" thick x 2" wide stile members, creating a five rectangular motif design. All edges of panel frame are eased.
	BA-V3A-6042		60"	42"	29"	160 Lbs.	7 Cu Ft	\$ 5,406	
	BA-V3A-6048		60"	48"	29"	230 Lbs.	9 Cu Ft	\$ 5,619	
	BA-V3A-7236	72"	36"	29"	190 Lbs.	8 Cu Ft	\$ 5,413		
	BA-V3A-7242	72"	42"	29"	215 Lbs.	10 Cu Ft	\$ 5,631		
	BA-V3A-7248	72"	48"	29"	230 Lbs.	10 Cu Ft	\$ 5,856		
	BA-V3A-8436	84"	36"	29"	230 Lbs.	8 Cu Ft	\$ 5,631		
	BA-V3A-8442	84"	42"	29"	245 Lbs.	9 Cu Ft	\$ 5,863		
	BA-V3A-8448	84"	48"	29"	290 Lbs.	10 Cu Ft	\$ 6,088		
	BA-V3A-9636	Rectangle Reading Table Version 3A – Acrylic	96"	36"	29"	290 Lbs.	10 Cu Ft	\$ 5,850	
	BA-V3A-9642		96"	42"	29"	310 Lbs.	12 Cu Ft	\$ 6,088	
	BA-V3A-9648		96"	48"	29"	320 Lbs.	12 Cu Ft	\$ 6,325	
		BA-V3M-6036	Rectangle Reading Table Version 3M – Molding	60"	36"	29"	175 Lbs.	9 Cu Ft	\$ 5,425
		BA-V3M-6042		60"	42"	29"	160 Lbs.	7 Cu Ft	\$ 5,650
		BA-V3M-6048		60"	48"	29"	230 Lbs.	9 Cu Ft	\$ 6,231
		BA-V3M-7236	72"	36"	29"	190 Lbs.	8 Cu Ft	\$ 5,644	
		BA-V3M-7242	72"	42"	29"	215 Lbs.	10 Cu Ft	\$ 5,881	
		BA-V3M-7248	72"	48"	29"	230 Lbs.	10 Cu Ft	\$ 6,469	
BA-V3M-8436		84"	36"	29"	230 Lbs.	8 Cu Ft	\$ 5,863		
BA-V3M-8442		84"	42"	29"	245 Lbs.	9 Cu Ft	\$ 6,106		
BA-V3M-8448		84"	48"	29"	290 Lbs.	10 Cu Ft	\$ 6,700		
	BA-V3M-9636	Rectangle Reading Table Version 3M – Molding	96"	36"	29"	290 Lbs.	10 Cu Ft	\$ 6,081	
	BA-V3M-9642		96"	42"	29"	310 Lbs.	12 Cu Ft	\$ 6,331	
	BA-V3M-9648		96"	48"	29"	320 Lbs.	12 Cu Ft	\$ 6,938	
		BA-V3S-6036	Rectangle Reading Table Version 3S – Shaker	60"	36"	29"	175 Lbs.	9 Cu Ft	\$ 4,981
		BA-V3S-6042		60"	42"	29"	160 Lbs.	7 Cu Ft	\$ 5,144
		BA-V3S-6048		60"	48"	29"	230 Lbs.	9 Cu Ft	\$ 5,313
		BA-V3S-7236	72"	36"	29"	190 Lbs.	8 Cu Ft	\$ 5,194	
		BA-V3S-7242	72"	42"	29"	215 Lbs.	10 Cu Ft	\$ 5,375	
		BA-V3S-7248	72"	48"	29"	230 Lbs.	10 Cu Ft	\$ 5,550	
BA-V3S-8436		84"	36"	29"	230 Lbs.	8 Cu Ft	\$ 5,413		
BA-V3S-8442		84"	42"	29"	245 Lbs.	9 Cu Ft	\$ 5,600		
BA-V3S-8448		84"	48"	29"	290 Lbs.	10 Cu Ft	\$ 5,781		
	BA-V3S-9636	Rectangle Reading Table Version 3S – Shaker	96"	36"	29"	290 Lbs.	10 Cu Ft	\$ 5,631	
	BA-V3S-9642		96"	42"	29"	310 Lbs.	12 Cu Ft	\$ 5,825	
	BA-V3S-9648		96"	48"	29"	320 Lbs.	12 Cu Ft	\$ 6,019	

	MODEL NUMBER	PRODUCT	W	D	H	WEIGHT	VOLUME	LIST PRICE	DESCRIPTION
	BA-V4A-6036	Rectangle Reading Table Version 4A – Acrylic	60"	36"	29"	175 Lbs.	9 Cu Ft	\$ 5,194	WORK SURFACE: Tops are constructed of 1 1/4" thick 3-ply particleboard core. Top surface is laminated with a .050" thick high pressure plastic laminate sheet and bottom surface laminated with a backing sheet not less than .020" thick for balanced construction. Surrounding edges will be 1 1/4" thick x 2 1/4" wide solid external hardwood knife profile with 1/2" rounded point and shall be mitered and radiused at corners. END PANELS: Version 4A: Panel frame construction consists of two 1 1/2" thick x 2 5/8" wide solid hardwood sides, 1 1/2" thick x 3 1/2" top member and a 1 1/2" thick x 5" wide bottom with a 2 1/2" arched center. Center frame will be fitted with one horizontal and two vertical 1 1/2" thick x 2" wide stile members, creating a rectangle and square motif design. All spaces are then fitted with 3/8" thick frosted acrylic inserts. All edges of panel frame are eased. Version 4M: Panel frame construction consists of a 1 1/16" thick 3-ply particleboard core with plain sliced veneer both faces, two 1 1/2" thick x 2 5/8" wide solid hardwood sides, 1 1/2" thick x 3 1/2" top member and a 1 1/2" thick x 5" wide bottom with a 2 1/2" arched center. Center frame will be fitted with one horizontal and two vertical 1/2" thick x 2" wide stile members, creating a rectangle and square motif design. All spaces are then miter framed with 7/16" thick X 3/4" wide angled solid hardwood trim creating a raised frame effect. All edges of panel frame and trim are eased. Version 4S: Panel frame construction consists of a 1 1/16" thick 3-ply particleboard core with plain sliced veneer both faces, two 1 1/2" thick x 2 5/8" wide solid hardwood sides, 1 1/2" thick x 3 1/2" top member and a 1 1/2" thick x 5" wide bottom with a 2 1/2" arched center. Center frame will be fitted with one horizontal and two vertical 1/2" thick x 2" wide stile members, creating a rectangle and square motif design. All edges of panel frame are eased.
	BA-V4A-6042		60"	42"	29"	160 Lbs.	7 Cu Ft	\$ 5,406	
	BA-V4A-6048		60"	48"	29"	230 Lbs.	9 Cu Ft	\$ 5,619	
	BA-V4A-7236	72"	36"	29"	190 Lbs.	8 Cu Ft	\$ 5,413		
	BA-V4A-7242	72"	42"	29"	215 Lbs.	10 Cu Ft	\$ 5,631		
	BA-V4A-7248	72"	48"	29"	230 Lbs.	10 Cu Ft	\$ 5,856		
	BA-V4A-8436	84"	36"	29"	230 Lbs.	8 Cu Ft	\$ 5,631		
	BA-V4A-8442	84"	42"	29"	245 Lbs.	9 Cu Ft	\$ 5,863		
	BA-V4A-8448	84"	48"	29"	290 Lbs.	10 Cu Ft	\$ 6,088		
	BA-V4M-6036	Rectangle Reading Table Version 4M – Molding	60"	36"	29"	175 Lbs.	9 Cu Ft	\$ 5,425	
	BA-V4M-6042		60"	42"	29"	160 Lbs.	7 Cu Ft	\$ 5,650	
	BA-V4M-6048		60"	48"	29"	230 Lbs.	9 Cu Ft	\$ 6,231	
	BA-V4M-7236	72"	36"	29"	190 Lbs.	8 Cu Ft	\$ 5,644		
	BA-V4M-7242	72"	42"	29"	215 Lbs.	10 Cu Ft	\$ 5,881		
	BA-V4M-7248	72"	48"	29"	230 Lbs.	10 Cu Ft	\$ 6,469		
	BA-V4M-8436	84"	36"	29"	230 Lbs.	8 Cu Ft	\$ 5,863		
	BA-V4M-8442	84"	42"	29"	245 Lbs.	9 Cu Ft	\$ 6,106		
	BA-V4M-8448	84"	48"	29"	290 Lbs.	10 Cu Ft	\$ 6,700		
	BA-V4S-6036	Rectangle Reading Table Version 4S – Shaker	60"	36"	29"	175 Lbs.	9 Cu Ft	\$ 4,981	
	BA-V4S-6042		60"	42"	29"	160 Lbs.	7 Cu Ft	\$ 5,144	
	BA-V4S-6048		60"	48"	29"	230 Lbs.	9 Cu Ft	\$ 5,313	
	BA-V4S-7236	72"	36"	29"	190 Lbs.	8 Cu Ft	\$ 5,194		
	BA-V4S-7242	72"	42"	29"	215 Lbs.	10 Cu Ft	\$ 5,375		
	BA-V4S-7248	72"	48"	29"	230 Lbs.	10 Cu Ft	\$ 5,550		
	BA-V4S-8436	84"	36"	29"	230 Lbs.	8 Cu Ft	\$ 5,413		
	BA-V4S-8442	84"	42"	29"	245 Lbs.	9 Cu Ft	\$ 5,600		
	BA-V4S-8448	84"	48"	29"	290 Lbs.	10 Cu Ft	\$ 5,781		
BA-V4S-9636	96"	36"	29"	290 Lbs.	10 Cu Ft	\$ 5,631			
BA-V4S-9642	96"	42"	29"	310 Lbs.	12 Cu Ft	\$ 5,825			
BA-V4S-9648	96"	48"	29"	320 Lbs.	12 Cu Ft	\$ 6,019			

	MODEL NUMBER	PRODUCT	W	D	H	WEIGHT	VOLUME	LIST PRICE	DESCRIPTION
	BA-V5A-6036	Rectangle Reading Table Version 5A – Acrylic	60"	36"	29"	175 Lbs.	9 Cu Ft	\$ 5,250	<p>WORK SURFACE: Tops are constructed of 1 1/4" thick 3-ply particleboard core. Top surface is laminated with a .050" thick high pressure plastic laminate sheet and bottom surface laminated with a backing sheet not less than .020" thick for balanced construction. Surrounding edges will be 1 1/4" thick x 2 1/4" wide solid external hardwood knife profile with 1/2" rounded point and shall be mitered and radiused at corners.</p> <p>END PANELS: Version 5A: Panel frame construction consists of two 1 1/2" thick x 2 5/8" wide solid hardwood sides, 1 1/2" thick x 3 1/2" top member and a 1 1/2" thick x 5" wide bottom with a 2 1/2" arched center. Center frame will be fitted with one horizontal and three vertical 1 1/2" thick x 2" wide stile members, creating an eight rectangular motif design. All spaces are then fitted with 3/8" thick frosted acrylic inserts. All edges of panel frame are eased.</p> <p>Version 5M: Panel frame construction consists of a 1 1/16" thick 3-ply particleboard core with plain sliced veneer both faces, two 1 1/2" thick x 2 5/8" wide solid hardwood sides, 1 1/2" thick x 3 1/2" top member and a 1-1/2" thick x 5" wide bottom with a 2-1/2" arched center. Center frame will be fitted with one horizontal and three vertical 1 1/2" thick x 2" wide stile members, creating an eight rectangular motif design. All spaces are then miter framed with 7/16" thick x 3/4" wide angled solid hardwood trim creating a raised frame effect. All edges of panel frame and trim are eased.</p> <p>Version 5S: Panel frame construction consists of a 1 1/16" thick 3-ply particleboard core with plain sliced veneer both faces, two 1 1/2" thick x 2 5/8" wide solid hardwood sides, 1 1/2" thick x 3 1/2" top member and a 1 1/2" thick x 5" wide bottom with a 2 1/2" arched center. Center frame will be fitted with one horizontal and three vertical 1 1/2" thick x 2" wide stile members, creating an eight rectangular motif design. All edges of panel frame are eased.</p>
	BA-V5A-6042		60"	42"	29"	160 Lbs.	7 Cu Ft	\$ 5,463	
	BA-V5A-6048		60"	48"	29"	230 Lbs.	9 Cu Ft	\$ 5,675	
	BA-V5A-7236	72"	36"	29"	190 Lbs.	8 Cu Ft	\$ 5,469		
	BA-V5A-7242	72"	42"	29"	215 Lbs.	10 Cu Ft	\$ 5,688		
	BA-V5A-7248	72"	48"	29"	230 Lbs.	10 Cu Ft	\$ 5,906		
	BA-V5A-8436	84"	36"	29"	230 Lbs.	8 Cu Ft	\$ 5,688		
	BA-V5A-8442	84"	42"	29"	245 Lbs.	9 Cu Ft	\$ 5,913		
	BA-V5A-8448	84"	48"	29"	290 Lbs.	10 Cu Ft	\$ 6,144		
BA-V5A-9636	96"	36"	29"	290 Lbs.	10 Cu Ft	\$ 5,906			
BA-V5A-9642	96"	42"	29"	310 Lbs.	12 Cu Ft	\$ 6,144			
BA-V5A-9648	96"	48"	29"	320 Lbs.	12 Cu Ft	\$ 6,375			
	BA-V5M-6036	Rectangle Reading Table Version 5M – Molding	60"	36"	29"	175 Lbs.	9 Cu Ft	\$ 5,531	
	BA-V5M-6042		60"	42"	29"	160 Lbs.	7 Cu Ft	\$ 5,756	
	BA-V5M-6048		60"	48"	29"	230 Lbs.	9 Cu Ft	\$ 6,344	
	BA-V5M-7236	72"	36"	29"	190 Lbs.	8 Cu Ft	\$ 5,750		
	BA-V5M-7242	72"	42"	29"	215 Lbs.	10 Cu Ft	\$ 5,988		
	BA-V5M-7248	72"	48"	29"	230 Lbs.	10 Cu Ft	\$ 6,575		
	BA-V5M-8436	84"	36"	29"	230 Lbs.	8 Cu Ft	\$ 5,969		
	BA-V5M-8442	84"	42"	29"	245 Lbs.	9 Cu Ft	\$ 6,213		
	BA-V5M-8448	84"	48"	29"	290 Lbs.	10 Cu Ft	\$ 6,813		
BA-V5M-9636	96"	36"	29"	290 Lbs.	10 Cu Ft	\$ 6,188			
BA-V5M-9642	96"	42"	29"	310 Lbs.	12 Cu Ft	\$ 6,438			
BA-V5M-9648	96"	48"	29"	320 Lbs.	12 Cu Ft	\$ 7,044			
	BA-V5S-6036	Rectangle Reading Table Version 5S – Shaker	60"	36"	29"	175 Lbs.	9 Cu Ft	\$ 5,013	
	BA-V5S-6042		60"	42"	29"	160 Lbs.	7 Cu Ft	\$ 5,350	
	BA-V5S-6048		60"	48"	29"	230 Lbs.	9 Cu Ft	\$ 5,181	
	BA-V5S-7236	72"	36"	29"	190 Lbs.	8 Cu Ft	\$ 5,231		
	BA-V5S-7242	72"	42"	29"	215 Lbs.	10 Cu Ft	\$ 5,588		
	BA-V5S-7248	72"	48"	29"	230 Lbs.	10 Cu Ft	\$ 5,406		
	BA-V5S-8436	84"	36"	29"	230 Lbs.	8 Cu Ft	\$ 5,450		
	BA-V5S-8442	84"	42"	29"	245 Lbs.	9 Cu Ft	\$ 5,819		
	BA-V5S-8448	84"	48"	29"	290 Lbs.	10 Cu Ft	\$ 5,631		
BA-V5S-9636	96"	36"	29"	290 Lbs.	10 Cu Ft	\$ 5,669			
BA-V5S-9642	96"	42"	29"	310 Lbs.	12 Cu Ft	\$ 6,056			
BA-V5S-9648	96"	48"	29"	320 Lbs.	12 Cu Ft	\$ 5,863			

	MODEL NUMBER	PRODUCT	W	D	H	WEIGHT	VOLUME	LIST PRICE	DESCRIPTION
	BA-V6A-6036	Rectangle Reading Table Version 6A – Acrylic	60"	36"	29"	175 Lbs.	9 Cu Ft	\$ 4,463	WORK SURFACE: Tops are constructed of 1 1/4" thick 3-ply particleboard core. Top surface is laminated with a .050" thick high pressure plastic laminate sheet and bottom surface laminated with a backing sheet not less than .020" thick for balanced construction. Surrounding edges will be 1 1/4" thick x 2 1/4" wide solid external hardwood knife profile with 1/2" rounded point and shall be mitered and radiused at corners.
	BA-V6A-6042		60"	42"	29"	160 Lbs.	7 Cu Ft	\$ 4,650	
	BA-V6A-6048		60"	48"	29"	230 Lbs.	9 Cu Ft	\$ 4,838	
	BA-V6A-7236	Rectangle Reading Table Version 6A – Acrylic	72"	36"	29"	190 Lbs.	8 Cu Ft	\$ 4,675	
	BA-V6A-7242		72"	42"	29"	215 Lbs.	10 Cu Ft	\$ 4,875	
	BA-V6A-7248		72"	48"	29"	230 Lbs.	10 Cu Ft	\$ 5,075	
	BA-V6A-8436	Rectangle Reading Table Version 6A – Acrylic	84"	36"	29"	230 Lbs.	8 Cu Ft	\$ 4,894	
	BA-V6A-8442		84"	42"	29"	245 Lbs.	9 Cu Ft	\$ 5,100	
	BA-V6A-8448		84"	48"	29"	290 Lbs.	10 Cu Ft	\$ 5,306	
BA-V6A-9636	Rectangle Reading Table Version 6A – Acrylic	96"	36"	29"	290 Lbs.	10 Cu Ft	\$ 5,113		
BA-V6A-9642		96"	42"	29"	310 Lbs.	12 Cu Ft	\$ 5,325		
BA-V6A-9648		96"	48"	29"	320 Lbs.	12 Cu Ft	\$ 5,544		
	BA-V6M-6036	Rectangle Reading Table Version 6M – Molding	60"	36"	29"	175 Lbs.	9 Cu Ft	\$ 4,681	END PANELS: Version 6A: Panel frame construction consists of two 1 1/2" thick x 2 5/8" wide solid hardwood sides, 1 1/2" thick x 3 1/2" top member and a 1 1/2" thick x 5" wide bottom with a 2 1/2" arched center. Center space is then fitted with 3/8" thick frosted acrylic inserts. All edges of panel frame are eased. Version 6M: Panel frame construction consists of a 1 1/16" thick 3-ply particleboard core with plain sliced veneer both faces, two 1 1/2" thick x 2 5/8" wide solid hardwood sides, 1 1/2" thick x 3 1/2" top member and a 1 1/2" thick x 5" wide bottom with a 2 1/2" arched center. Center space is then miter framed with 7/16" thick x 3/4" wide angled solid hardwood trim creating a raised frame effect. All edges of panel frame and trim are eased. Version 6S: Panel frame construction consists of a 1 1/16" thick 3-ply particleboard core with plain sliced veneer both faces, two 1 1/2" thick x 2 5/8" wide solid hardwood sides, 1 1/2" thick x 3 1/2" top member and a 1 1/2" thick x 5" wide bottom with a 2 1/2" arched center. All edges of panel frame are eased.
	BA-V6M-6042		60"	42"	29"	160 Lbs.	7 Cu Ft	\$ 4,863	
	BA-V6M-6048		60"	48"	29"	230 Lbs.	9 Cu Ft	\$ 5,044	
	BA-V6M-7236	Rectangle Reading Table Version 6M – Molding	72"	36"	29"	190 Lbs.	8 Cu Ft	\$ 4,900	
	BA-V6M-7242		72"	42"	29"	215 Lbs.	10 Cu Ft	\$ 5,088	
	BA-V6M-7248		72"	48"	29"	230 Lbs.	10 Cu Ft	\$ 5,281	
	BA-V6M-8436	Rectangle Reading Table Version 6M – Molding	84"	36"	29"	230 Lbs.	8 Cu Ft	\$ 5,119	
	BA-V6M-8442		84"	42"	29"	245 Lbs.	9 Cu Ft	\$ 5,313	
	BA-V6M-8448		84"	48"	29"	290 Lbs.	10 Cu Ft	\$ 5,513	
BA-V6M-9636	Rectangle Reading Table Version 6M – Molding	96"	36"	29"	290 Lbs.	10 Cu Ft	\$ 5,331		
BA-V6M-9642		96"	42"	29"	310 Lbs.	12 Cu Ft	\$ 5,544		
BA-V6M-9648		96"	48"	29"	320 Lbs.	12 Cu Ft	\$ 5,750		
	BA-V6S-6036	Rectangle Reading Table Version 6S – Shaker	60"	36"	29"	175 Lbs.	9 Cu Ft	\$ 4,313	
	BA-V6S-6042		60"	42"	29"	160 Lbs.	7 Cu Ft	\$ 4,463	
	BA-V6S-6048		60"	48"	29"	230 Lbs.	9 Cu Ft	\$ 4,619	
	BA-V6S-7236	Rectangle Reading Table Version 6S – Shaker	72"	36"	29"	190 Lbs.	8 Cu Ft	\$ 4,531	
	BA-V6S-7242		72"	42"	29"	215 Lbs.	10 Cu Ft	\$ 4,694	
	BA-V6S-7248		72"	48"	29"	230 Lbs.	10 Cu Ft	\$ 4,856	
	BA-V6S-8436	Rectangle Reading Table Version 6S – Shaker	84"	36"	29"	230 Lbs.	8 Cu Ft	\$ 4,750	
	BA-V6S-8442		84"	42"	29"	245 Lbs.	9 Cu Ft	\$ 4,919	
	BA-V6S-8448		84"	48"	29"	290 Lbs.	10 Cu Ft	\$ 5,088	
BA-V6S-9636	Rectangle Reading Table Version 6S – Shaker	96"	36"	29"	290 Lbs.	10 Cu Ft	\$ 4,969		
BA-V6S-9642		96"	42"	29"	310 Lbs.	12 Cu Ft	\$ 5,144		
BA-V6S-9648		96"	48"	29"	320 Lbs.	12 Cu Ft	\$ 5,325		



MODEL NUMBER	PRODUCT	W	D	H	WEIGHT	VOLUME	LIST PRICE	DESCRIPTION
EL-AS	Atlas Stand	30 ¹ / ₂ "	29"	44 ¹ / ₂ "	260 Lbs.	30 Cu Ft	\$ 4,106	<p>TOP: Sloped top is constructed of ³/₄" particleboard core with plastic laminate surfaces and fitted with a wood book rail ⁵/₈" thick x ⁵/₈" wide.</p> <p>CONSTRUCTION ASSEMBLY: Cabinet construction consists of a ³/₄" thick 3-ply particleboard core back with plain sliced veneer both faces, five ³/₄" thick 3-ply particleboard core pull-out shelves with ³/₄" thick x 1³/₄" high solid wood retainer lip operating on bottom mounted single extension drawer runners.</p> <p>END PANELS: Panel frame construction consists of a 1³/₁₆" thick 3-ply particleboard core with plain sliced veneer both faces and externally banded on all four sides with a ¹/₄" thick solid hardwood. Panels are fitted with two ¹/₂" wide horizontal decorative metal bars spaced 5" apart. All edges of panel frame are eased.</p>



MODEL NUMBER	PRODUCT	W	D	H	WEIGHT	VOLUME	LIST PRICE	DESCRIPTION
EL-DC	Dictionary Stand	27 ¹ / ₂ "	21"	44 ¹ / ₄ "	180 Lbs.	20 Cu Ft	\$ 3,019	<p>TOP: Sloped top is constructed of ³/₄" particleboard core with plastic laminate surfaces and fitted with a wood book rail ⁵/₈" thick x ⁵/₈" wide.</p> <p>CONSTRUCTION ASSEMBLY: Cabinet construction consists of a ³/₄" thick 3-ply particleboard core back with plain sliced veneer both faces, a ³/₄" thick 3-ply particleboard core adjustable shelf and a ³/₄" thick 3-ply particleboard core fixed bottom shelf with ³/₄" thick x 1³/₄" high solid wood drop edge.</p> <p>END PANELS: Panel frame construction consists of a 1³/₁₆" thick 3-ply particleboard core with plain sliced veneer both faces and externally banded on all four sides with a ¹/₄" thick solid hardwood. Panels are fitted with two ¹/₂" wide horizontal decorative metal bars spaced 5" apart. All edges of panel frame are eased.</p>



MODEL NUMBER	PRODUCT	W	D	H	WEIGHT	VOLUME	LIST PRICE	DESCRIPTION
--------------	---------	---	---	---	--------	--------	------------	-------------





Single Face Modular Carrels:								
EL-MC-36-SS	36" Starter	37 1/2"	31"	48"	340 Lbs.	11 Cu Ft	\$ 2,888	WORK SURFACE: Tops are constructed of 1 1/4" thick 3-ply particleboard core. Top surface is laminated with a .050" thick high pressure plastic laminate sheet and bottom surface laminated with a backing sheet not less than .020" thick for balanced construction. Front work surface edge is 1/4" thick x 1 1/4" high solid external hardwood with edges eased. Work surface is 28" deep x 29" high. END PANELS: Panel frame construction consists of a 1 3/16" thick 3-ply particleboard core with plain sliced veneer both faces and externally banded on all four sides with a 1/4" thick solid hardwood. Panels are fitted with two 1/2" wide horizontal decorative metal bars spaced 5" apart. All edges of panel frame are eased. INTERMEDIATE PANELS Panels are constructed of 1 3/16" thick 3-ply particleboard core with plain sliced veneer both faces, 1/4" solid hardwood framed on four sides with all edges eased. BACK PANEL: Back is constructed of 1 3/16" thick 3-ply particleboard core with plain sliced veneer both faces, 1/4" solid hardwood at top and bottom with eased edges. TOP SHELF: Shelf construction consists of 3/4" thick 3-ply particleboard core with plain sliced veneer both faces and the front edge is banded with a 1/4" solid external edge. Shelf is 9" deep positioned 16 1/4" above the work surface.
EL-MC-36-SA	36" Adder	36 1/4"	31"	48"	165 Lbs.	11 Cu Ft	\$ 2,306	
EL-MC-48-SS	48" Starter	49 1/2"	31"	48"	370 Lbs.	11 Cu Ft	\$ 2,963	
EL-MC-48-SA	48" Adder	48 1/4"	31"	48"	200 Lbs.	11 Cu Ft	\$ 2,381	



Double Face Modular Carrels:								
EL-MC-36-DS	36" Starter	37 1/2"	59 1/2"	48"	715 Lbs.	22 Cu Ft	\$ 4,206	
EL-MC-36-DA	36" Adder	36 1/4"	59 1/2"	48"	250 Lbs.	22 Cu Ft	\$ 3,119	
EL-MC-48-DS	48" Starter	49 1/2"	59 1/2"	48"	715 Lbs.	22 Cu Ft	\$ 4,325	
EL-MC-48-DA	48" Adder	48 1/4"	59 1/2"	48"	310 Lbs.	22 Cu Ft	\$ 3,238	

	MODEL NUMBER	PRODUCT	W	D	H	WEIGHT	VOLUME	LIST PRICE	DESCRIPTION
		Single Face Reference Carrels:							
	EL-RC-36-SS	36" Starter	37 ¹ / ₂ "	31"	48"	340 Lbs.	11 Cu Ft	\$ 3,056	<p>WORK SURFACE: Tops are constructed of 1¹/₄" thick 3-ply particleboard core. Top surface is laminated with a .050" thick high pressure plastic laminate sheet and bottom surface laminated with a backing sheet not less than .020" thick for balanced construction. Front work surface edge is 1¹/₄" thick x 1¹/₄" high solid external hardwood with edges eased. Tops will be set back from the back panel 2" to provide a wire drop and will be fitted with a retainer lip. Work surface is 26" deep and is adjustable at four increments 39", 32", 29" and 27" high.</p> <p>END PANELS: Panel frame construction consists of a 1³/₁₆" thick 3-ply particleboard core with plain sliced veneer both faces and externally banded on all four sides with a 1¹/₄" thick solid hardwood. Panels are fitted with two 1¹/₂" wide horizontal decorative metal bars spaced 5" apart. All edges of panel frame are eased.</p> <p>INTERMEDIATE PANELS Panels are constructed of 1³/₁₆" thick 3-ply particleboard core with plain sliced veneer both faces, 1¹/₄" solid hardwood framed on four sides with all edges eased.</p> <p>BACK PANEL: Back is constructed of 1³/₁₆" thick 3-ply particleboard core with plain sliced veneer both faces, 1¹/₄" solid hardwood at top and bottom with eased edges.</p> <p>BOTTOM SHELF: Shelf construction consists of 3³/₄" thick 3-ply particleboard core with plain sliced veneer both faces and the front edge is banded with a 1¹/₄" solid external edge. Shelf is 12" deep positioned 21" above the floor.</p>
	EL-RC-36-SA	36" Adder	36 ¹ / ₄ "	31"	48"	165 Lbs.	11 Cu Ft	\$ 2,475	
	EL-RC-48-SS	48" Starter	49 ¹ / ₂ "	31"	48"	370 Lbs.	11 Cu Ft	\$ 3,125	
EL-RC-48-SA	48" Adder	48 ¹ / ₄ "	31"	48"	200 Lbs.	11 Cu Ft	\$ 2,544		
		Double Face Reference Carrels:							
	EL-RC-36-DS	36" Starter	37 ¹ / ₂ "	59 ¹ / ₂ "	48"	715 Lbs.	22 Cu Ft	\$ 4,538	
	EL-RC-36-DA	36" Adder	36 ¹ / ₄ "	59 ¹ / ₂ "	48"	250 Lbs.	22 Cu Ft	\$ 3,450	
	EL-RC-48-DS	48" Starter	49 ¹ / ₂ "	59 ¹ / ₂ "	48"	715 Lbs.	22 Cu Ft	\$ 4,656	
EL-RC-48-DA	48" Adder	48 ¹ / ₄ "	59 ¹ / ₂ "	48"	310 Lbs.	22 Cu Ft	\$ 3,569		

MODEL NUMBER	PRODUCT	W	D	H	WEIGHT	VOLUME	LIST PRICE	DESCRIPTION	
									
1 Person PAC Tables:									
EL-PAC-1-29-W	Sitting Height, Wood Divider	36"	36"	37"	65 Lbs.	10 Cu Ft	\$ 3,613	<p>WORK SURFACE: Tops are constructed of 1 1/4" thick 3-ply particleboard core. Top surface is laminated with a .050" thick high pressure plastic laminate sheet and bottom surface laminated with a backing sheet not less than .020" thick for balanced construction. Surrounding edges will be banded with a 1/2" thick x 1 1/2" solid hardwood external edge. All edges are eased.</p> <p>TABLE TOP SUPPORTS: All tables 60" and longer will be fitted with a v-shaped, 14 gauge steel keel. All tables 48" wide and 60" long and longer will be fitted with two parallel steel keels.</p> <p>LEG ASSEMBLY: Legs are 2 3/8" x 2 3/8" glued up solid stock. The two inside edges are tapered down to 1 1/2" x 1 1/2". The leg is attached to a 5" x 5" x 1/4" thick steel plate by means of two threaded machine bolts fastened to a barrel nut embedded in the leg. Two steel decorative angle bars are attached to the upper outside corners of the leg spaced 5" apart. Plate and leg assembly shall be mounted to the underside of the table top by means of threaded inserts embedded in the underside of the top. Inserts are capable of receiving machine bolts.</p> <p>WOOD DIVIDERS: Sloped side dividers constructed of 3/4" thick x 8" high solid hardwood and back divider constructed of 3/4" x 7 3/4" high veneer particleboard, top edge banded with 1/4" external hardwood.</p> <p>ACRYLIC DIVIDERS: Sloped side panels and rectangular back divider consisting of 1/4" thick x 8" high frosted acrylic complete with diameter brushed steel stand-off.</p> <p>WORK SURFACE HEIGHT: Table heights of 25" (children), 27" (youth), and 32" (wheelchair) are available by request.</p> <p>ELECTRICAL ACCESSORIES: Each seating position shall receive a 3" diameter black plastic grommet and a black metal j-channel for wire management.</p>	
EL-PAC-1-29-A	Sitting Height, Acrylic Divider	36"	36"	37"	65 Lbs.	10 Cu Ft	\$ 3,800		
EL-PAC-1-32-W	Wheelchair Height, Wood Divider	36"	36"	40"	65 Lbs.	10 Cu Ft	\$ 3,669		
EL-PAC-1-32-A	Wheelchair Height, Acrylic Divider	36"	36"	40"	65 Lbs.	10 Cu Ft	\$ 3,856		
EL-PAC-1-39-W	Standing Height, Wood Divider	36"	36"	47"	67 Lbs.	10 Cu Ft	\$ 3,706		
EL-PAC-1-39-A	Standing Height, Acrylic Divider	36"	36"	47"	67 Lbs.	10 Cu Ft	\$ 3,900		
									
2 Person (1 Place Back to Back) PAC Tables:									
EL-PAC-1D-29-W	Sitting Height, Wood Divider	36"	48"	37"	65 Lbs.	10 Cu Ft	\$ 3,756		
EL-PAC-1D-29-A	Sitting Height, Acrylic Divider	36"	48"	37"	65 Lbs.	10 Cu Ft	\$ 3,994		
EL-PAC-1D-32-W	Wheelchair Height, Wood Divider	36"	48"	40"	65 Lbs.	10 Cu Ft	\$ 3,813		
EL-PAC-1D-32-A	Wheelchair Height, Acrylic Divider	36"	48"	40"	65 Lbs.	10 Cu Ft	\$ 4,050		
EL-PAC-1D-39-W	Standing Height, Wood Divider	36"	48"	47"	67 Lbs.	10 Cu Ft	\$ 3,913		
EL-PAC-1D-39-A	Standing Height, Acrylic Divider	36"	48"	47"	67 Lbs.	10 Cu Ft	\$ 4,150		

MODEL NUMBER	PRODUCT	W	D	H	WEIGHT	VOLUME	LIST PRICE	DESCRIPTION
--------------	---------	---	---	---	--------	--------	------------	-------------





2 Person PAC Tables:



EL-PAC-2-29-W	Sitting Height, Wood Divider	72"	36"	37"	100 Lbs.	21 Cu Ft	\$ 4,031	<p>WORK SURFACE: Tops are constructed of 1 1/4" thick 3-ply particleboard core. Top surface is laminated with a .050" thick high pressure plastic laminate sheet and bottom surface laminated with a backing sheet not less than .020" thick for balanced construction. Surrounding edges will be banded with a 1/2" thick x 1 1/2" solid hardwood external edge. All edges are eased.</p> <p>TABLE TOP SUPPORTS: All tables 60" and longer will be fitted with a v-shaped, 14 gauge steel keel. All tables 48" wide and 60" long and longer will be fitted with two parallel steel keels.</p> <p>LEG ASSEMBLY: Legs are 2 3/8" x 2 3/8" glued up solid stock. The two inside edges are tapered down to 1 1/2" x 1 1/2". The leg is attached to a 5" x 5" x 1/4" thick steel plate by means of two threaded machine bolts fastened to a barrel nut embedded in the leg. Two steel decorative angle bars are attached to the upper outside corners of the leg spaced 5" apart. Plate and leg assembly shall be mounted to the underside of the table top by means of threaded inserts embedded in the underside of the top. Inserts are capable of receiving machine bolts.</p> <p>WOOD DIVIDERS: Sloped side dividers constructed of 3/4" thick x 8" high solid hardwood and back divider constructed of 3/4" x 7 3/4" high veneer particleboard, top edge banded with 1/4" external hardwood.</p> <p>ACRYLIC DIVIDERS: Sloped side panels and rectangular back divider consisting of 1/4" thick x 8" high frosted acrylic complete with diameter brushed steel stand-off.</p> <p>WORK SURFACE HEIGHT: Table heights of 25" (children), 27" (youth), and 32" (wheelchair) are available by request.</p> <p>ELECTRICAL ACCESSORIES: Each seating position shall receive a 3" diameter black plastic grommet and a black metal j-channel for wire management.</p>
EL-PAC-2-29-A	Sitting Height, Acrylic Divider	72"	36"	37"	100 Lbs.	21 Cu Ft	\$ 4,625	
EL-PAC-2-32-W	Wheelchair Height, Wood Divider	72"	36"	40"	100 Lbs.	21 Cu Ft	\$ 4,088	
EL-PAC-2-32-A	Wheelchair Height, Acrylic Divider	72"	36"	40"	100 Lbs.	21 Cu Ft	\$ 4,681	
EL-PAC-2-39-W	Standing Height, Wood Divider	72"	36"	47"	100 Lbs.	21 Cu Ft	\$ 4,219	
EL-PAC-2-39-A	Standing Height, Acrylic Divider	72"	36"	47"	100 Lbs.	21 Cu Ft	\$ 4,813	







4 Person (2 Place Back to Back) PAC Tables:



EL-PAC-2D-29-W	Sitting Height, Wood Divider	72"	48"	37"	100 Lbs.	21 Cu Ft	\$ 4,538
EL-PAC-2D-29-A	Sitting Height, Acrylic Divider	72"	48"	37"	100 Lbs.	21 Cu Ft	\$ 5,013
EL-PAC-2D-32-W	Wheelchair Height, Wood Divider	72"	48"	40"	100 Lbs.	21 Cu Ft	\$ 4,594
EL-PAC-2D-32-A	Wheelchair Height, Acrylic Divider	72"	48"	40"	100 Lbs.	21 Cu Ft	\$ 5,069
EL-PAC-2D-39-W	Standing Height, Wood Divider	72"	48"	47"	100 Lbs.	21 Cu Ft	\$ 4,688
EL-PAC-2D-39-A	Standing Height, Acrylic Divider	72"	48"	47"	100 Lbs.	21 Cu Ft	\$ 5,163

MODEL NUMBER	PRODUCT	W	D	H	WEIGHT	VOLUME	LIST PRICE	DESCRIPTION	
									
3 Person PAC Tables:									
EL-PAC-3-29-W	Sitting Height, Wood Divider	90"	36"	37"	110 Lbs.	26 Cu Ft	\$ 4,256	<p>WORK SURFACE: Tops are constructed of 1 1/4" thick 3-ply particleboard core. Top surface is laminated with a .050" thick high pressure plastic laminate sheet and bottom surface laminated with a backing sheet not less than .020" thick for balanced construction. Surrounding edges will be banded with a 1/2" thick x 1 1/2" solid hardwood external edge. All edges are eased.</p> <p>TABLE TOP SUPPORTS: All tables 60" and longer will be fitted with a v-shaped, 14 gauge steel keel. All tables 48" wide and 60" long and longer will be fitted with two parallel steel keels.</p> <p>LEG ASSEMBLY: Legs are 2 3/8" x 2 3/8" glued up solid stock. The two inside edges are tapered down to 1 1/2" x 1 1/2". The leg is attached to a 5" x 5" x 1/4" thick steel plate by means of two threaded machine bolts fastened to a barrel nut embedded in the leg. Two steel decorative angle bars are attached to the upper outside corners of the leg spaced 5" apart. Plate and leg assembly shall be mounted to the underside of the table top by means of threaded inserts embedded in the underside of the top. Inserts are capable of receiving machine bolts.</p> <p>WOOD DIVIDERS: Sloped side dividers constructed of 3/4" thick x 8" high solid hardwood and back divider constructed of 3/4" x 7 3/4" high veneer particleboard, top edge banded with 1/4" external hardwood.</p> <p>ACRYLIC DIVIDERS: Sloped side panels and rectangular back divider consisting of 1/4" thick x 8" high frosted acrylic complete with diameter brushed steel stand-off.</p> <p>WORK SURFACE HEIGHT: Table heights of 25" (children), 27" (youth), and 32" (wheelchair) are available by request.</p> <p>ELECTRICAL ACCESSORIES: Each seating position shall receive a 3" diameter black plastic grommet and a black metal j-channel for wire management.</p>	
EL-PAC-3-29-A	Sitting Height, Acrylic Divider	90"	36"	37"	110 Lbs.	26 Cu Ft	\$ 5,281		
EL-PAC-3-32-W	Wheelchair Height, Wood Divider	90"	36"	40"	110 Lbs.	26 Cu Ft	\$ 4,313		
EL-PAC-3-32-A	Wheelchair Height, Acrylic Divider	90"	36"	40"	110 Lbs.	26 Cu Ft	\$ 5,338		
EL-PAC-3-39-W	Standing Height, Wood Divider	90"	36"	47"	114 Lbs.	26 Cu Ft	\$ 4,531		
EL-PAC-3-39-A	Standing Height, Acrylic Divider	90"	36"	47"	114 Lbs.	26 Cu Ft	\$ 5,550		
									
6 Person (3 Place Back to Back) PAC Tables:									
EL-PAC-3D-29-W	Sitting Height, Wood Divider	90"	48"	37"	110 Lbs.	26 Cu Ft	\$ 4,850		
EL-PAC-3D-29-A	Sitting Height, Acrylic Divider	90"	48"	37"	110 Lbs.	26 Cu Ft	\$ 5,763		
EL-PAC-3D-32-W	Wheelchair Height, Wood Divider	90"	48"	40"	110 Lbs.	26 Cu Ft	\$ 4,906		
EL-PAC-3D-32-A	Wheelchair Height, Acrylic Divider	90"	48"	40"	110 Lbs.	26 Cu Ft	\$ 5,819		
EL-PAC-3D-39-W	Standing Height, Wood Divider	90"	48"	47"	114 Lbs.	26 Cu Ft	\$ 5,088		
EL-PAC-3D-39-A	Standing Height, Acrylic Divider	90"	48"	47"	114 Lbs.	26 Cu Ft	\$ 6,000		

MODEL NUMBER	PRODUCT	W	D	H	WEIGHT	VOLUME	LIST PRICE	DESCRIPTION	
									
1 Person PAC Tables, Panel Base:									
EL-PAC-1-PB-29-W	Sitting Height, Wood Divider	36"	36"	37"	65 Lbs.	10 Cu Ft	\$ 2,769	<p>WORK SURFACE: Tops are constructed of 1 1/4" thick 3-ply particleboard core. Top surface is laminated with a .050" thick high pressure plastic laminate sheet and bottom surface laminated with a backing sheet not less than .020" thick for balanced construction. Front work surface edge is 1/4" thick x 1 1/4" high solid external hardwood with edges eased.</p> <p>TABLE TOP SUPPORTS: All tables will be fitted with a 1" thick x 6" high 3-ply particleboard core wood keel. All tables 48" wide and 60" long and longer will be fitted with two parallel wood keels.</p> <p>END PANELS: Panel frame construction consists of a 1 3/16" thick 3-ply particleboard core with plain sliced veneer both faces and externally banded on all four sides with a 1/4" thick solid hardwood. Panels are fitted with two 1/2" wide horizontal decorative metal bars spaced 5" apart. All edges of panel frame are eased.</p> <p>WOOD DIVIDERS: Sloped side dividers constructed of 3/4" thick x 8" high solid hardwood and back divider constructed of 3/4" x 7 3/4" high veneer particleboard, top edge banded with 1/4" external hardwood.</p> <p>ACRYLIC DIVIDERS: Sloped side panels and rectangular back divider consisting of 1/4" thick x 8" high frosted acrylic complete with diameter brushed steel stand-off.</p> <p>WORK SURFACE HEIGHT: Table heights of 25" (children), 27" (youth), and 32" (wheelchair) are available by request.</p> <p>ELECTRICAL ACCESSORIES: Each seating position shall receive a 3" diameter black plastic grommet and a black metal j-channel for wire management.</p>	
EL-PAC-1-PB-29-A	Sitting Height, Acrylic Divider	36"	36"	37"	65 Lbs.	10 Cu Ft	\$ 3,138		
EL-PAC-1-PB-32-W	Wheelchair Height, Wood Divider 36"	36"	36"	40"	65 Lbs.	10 Cu Ft	\$ 2,781		
EL-PAC-1-PB-32-A	Wheelchair Height, Acrylic Divider 36"	36"	36"	40"	65 Lbs.	10 Cu Ft	\$ 3,150		
EL-PAC-1-PB-39-W	Standing Height, Wood Divider	36"	36"	47"	67 Lbs.	10 Cu Ft	\$ 2,825		
EL-PAC-1-PB-39-A	Standing Height, Acrylic Divider	36"	36"	47"	67 Lbs.	10 Cu Ft	\$ 3,194		
									
2 Person (1 Place Back to Back) PAC Tables, Panel Base:									
EL-PAC-1D-PB-29-W	Sitting Height, Wood Divider	36"	48"	37"	65 Lbs.	10 Cu Ft	\$ 3,200		
EL-PAC-1D-PB-29-A	Sitting Height, Acrylic Divider	36"	48"	37"	65 Lbs.	10 Cu Ft	\$ 3,613		
EL-PAC-1D-PB-32-W	Wheelchair Height, Wood Divider 36"	36"	48"	40"	65 Lbs.	10 Cu Ft	\$ 3,219		
EL-PAC-1D-PB-32-A	Wheelchair Height, Acrylic Divider 36"	36"	48"	40"	65 Lbs.	10 Cu Ft	\$ 3,631		
EL-PAC-1D-PB-39-W	Standing Height, Wood Divider	36"	48"	47"	67 Lbs.	10 Cu Ft	\$ 3,250		
EL-PAC-1D-PB-39-A	Standing Height, Acrylic Divider	36"	48"	47"	67 Lbs.	10 Cu Ft	\$ 3,669		

MODEL NUMBER	PRODUCT	W	D	H	WEIGHT	VOLUME	LIST PRICE	DESCRIPTION	
									
2 Person PAC Tables, Panel Base:									
EL-PAC-2-PB-29-W	Sitting Height, Wood Divider	72"	36"	37"	100 Lbs.	21 Cu Ft	\$ 3,031	<p>WORK SURFACE: Tops are constructed of 1 1/4" thick 3-ply particleboard core. Top surface is laminated with a .050" thick high pressure plastic laminate sheet and bottom surface laminated with a backing sheet not less than .020" thick for balanced construction. Front work surface edge is 1/4" thick x 1 1/4" high solid external hardwood with edges eased.</p> <p>TABLE TOP SUPPORTS: All tables will be fitted with a 1" thick x 6" high 3-ply particleboard core wood keel. All tables 48" wide and 60" long and longer will be fitted with two parallel wood keels.</p> <p>END PANELS: Panel frame construction consists of a 1 3/16" thick 3-ply particleboard core with plain sliced veneer both faces and externally banded on all four sides with a 1/4" thick solid hardwood. Panels are fitted with two 1/2" wide horizontal decorative metal bars spaced 5" apart. All edges of panel frame are eased.</p> <p>WOOD DIVIDERS: Sloped side dividers constructed of 3/4" thick x 8" high solid hardwood and back divider constructed of 3/4" x 7 3/4" high veneer particleboard, top edge banded with 1/4" external hardwood.</p> <p>ACRYLIC DIVIDERS: Sloped side panels and rectangular back divider consisting of 1/4" thick x 8" high frosted acrylic complete with diameter brushed steel stand-off.</p> <p>WORK SURFACE HEIGHT: Table heights of 25" (children), 27" (youth), and 32" (wheelchair) are available by request.</p> <p>ELECTRICAL ACCESSORIES: Each seating position shall receive a 3" diameter black plastic grommet and a black metal j-channel for wire management.</p>	
EL-PAC-2-PB-29-A	Sitting Height, Acrylic Divider	72"	36"	37"	100 Lbs.	21 Cu Ft	\$ 3,800		
EL-PAC-2-PB-32-W	Wheelchair Height, Wood Divider 72"	72"	36"	40"	100 Lbs.	21 Cu Ft	\$ 3,044		
EL-PAC-2-PB-32-A	Wheelchair Height, Acrylic Divider 72"	72"	36"	40"	100 Lbs.	21 Cu Ft	\$ 3,813		
EL-PAC-2-PB-39-W	Standing Height, Wood Divider	72"	36"	47"	100 Lbs.	21 Cu Ft	\$ 3,081		
EL-PAC-2-PB-39-A	Standing Height, Acrylic Divider	72"	36"	47"	100 Lbs.	21 Cu Ft	\$ 3,856		
									
4 Person (2 Place Back to Back) PAC Tables, Panel Base:									
EL-PAC-2D-PB-29-W	Sitting Height, Wood Divider	72"	48"	37"	100 Lbs.	21 Cu Ft	\$ 3,550		
EL-PAC-2D-PB-29-A	Sitting Height, Acrylic Divider	72"	48"	37"	100 Lbs.	21 Cu Ft	\$ 4,406		
EL-PAC-2D-PB-32-W	Wheelchair Height, Wood Divider 72"	72"	48"	40"	100 Lbs.	21 Cu Ft	\$ 3,569		
EL-PAC-2D-PB-32-A	Wheelchair Height, Acrylic Divider 72"	72"	48"	40"	100 Lbs.	21 Cu Ft	\$ 4,425		
EL-PAC-2D-PB-39-W	Standing Height, Wood Divider	72"	48"	47"	100 Lbs.	21 Cu Ft	\$ 3,606		
EL-PAC-2D-PB-39-A	Standing Height, Acrylic Divider	72"	48"	47"	100 Lbs.	21 Cu Ft	\$ 4,456		

MODEL NUMBER	PRODUCT	W	D	H	WEIGHT	VOLUME	LIST PRICE	DESCRIPTION	
									
3 Person PAC Tables, Panel Base:									
EL-PAC-3-PB-29-W	Sitting Height, Wood Divider	90"	36"	37"	110 Lbs.	26 Cu Ft	\$ 3,225	<p>WORK SURFACE: Tops are constructed of 1 1/4" thick 3-ply particleboard core. Top surface is laminated with a .050" thick high pressure plastic laminate sheet and bottom surface laminated with a backing sheet not less than .020" thick for balanced construction. Front work surface edge is 1/4" thick x 1 1/4" high solid external hardwood with edges eased.</p> <p>TABLE TOP SUPPORTS: All tables will be fitted with a 1" thick x 6" high 3-ply particleboard core wood keel. All tables 48" wide and 60" long and longer will be fitted with two parallel wood keels.</p> <p>END PANELS: Panel frame construction consists of a 1 3/16" thick 3-ply particleboard core with plain sliced veneer both faces and externally banded on all four sides with a 1/4" thick solid hardwood. Panels are fitted with two 1/2" wide horizontal decorative metal bars spaced 5" apart. All edges of panel frame are eased.</p> <p>WOOD DIVIDERS: Sloped side dividers constructed of 3/4" thick x 8" high solid hardwood and back divider constructed of 3/4" x 7 3/4" high veneer particleboard, top edge banded with 1/4" external hardwood.</p> <p>ACRYLIC DIVIDERS: Sloped side panels and rectangular back divider consisting of 1/4" thick x 8" high frosted acrylic complete with diameter brushed steel stand-off.</p> <p>WORK SURFACE HEIGHT: Table heights of 25" (children), 27" (youth), and 32" (wheelchair) are available by request.</p> <p>ELECTRICAL ACCESSORIES: Each seating position shall receive a 3" diameter black plastic grommet and a black metal j-channel for wire management.</p>	
EL-PAC-3-PB-29-A	Sitting Height, Acrylic Divider	90"	36"	37"	110 Lbs.	26 Cu Ft	\$ 4,425		
EL-PAC-3-PB-32-W	Wheelchair Height, Wood Divider	90"	36"	40"	110 Lbs.	26 Cu Ft	\$ 3,231		
EL-PAC-3-PB-32-A	Wheelchair Height, Acrylic Divider	90"	36"	40"	110 Lbs.	26 Cu Ft	\$ 4,431		
EL-PAC-3-PB-39-W	Standing Height, Wood Divider	90"	36"	47"	114 Lbs.	26 Cu Ft	\$ 3,275		
EL-PAC-3-PB-39-A	Standing Height, Acrylic Divider	90"	36"	47"	114 Lbs.	26 Cu Ft	\$ 4,475		
									
6 Person (3 Place Back to Back) PAC Tables, Panel Base:									
EL-PAC-3D-PB-29-W	Sitting Height, Wood Divider	90"	48"	37"	110 Lbs.	26 Cu Ft	\$ 4,031		
EL-PAC-3D-PB-29-A	Sitting Height, Acrylic Divider	90"	48"	37"	110 Lbs.	26 Cu Ft	\$ 5,300		
EL-PAC-3D-PB-32-W	Wheelchair Height, Wood Divider	90"	48"	40"	110 Lbs.	26 Cu Ft	\$ 4,050		
EL-PAC-3D-PB-32-A	Wheelchair Height, Acrylic Divider	90"	48"	40"	110 Lbs.	26 Cu Ft	\$ 5,319		
EL-PAC-3D-PB-39-W	Standing Height, Wood Divider	90"	48"	47"	114 Lbs.	26 Cu Ft	\$ 4,088		
EL-PAC-3D-PB-39-A	Standing Height, Acrylic Divider	90"	48"	47"	114 Lbs.	26 Cu Ft	\$ 5,350		

	MODEL NUMBER	PRODUCT	W	D	H	WEIGHT	VOLUME	LIST PRICE	DESCRIPTION
	EL-R36	Round Reading Tables	36"	36"	29"	90 Lbs.	8 Cu Ft	\$ 2,869	<p>WORK SURFACE: Tops are constructed of 1 1/4" thick 3-ply particleboard core. Top surface is laminated with a .050" thick high pressure plastic laminate sheet and bottom surface laminated with a backing sheet not less than .020" thick for balanced construction. Surrounding edges will be banded with a 1/2" thick x 1 1/2" solid hardwood external edge. All edges are eased.</p> <p>TABLE TOP SUPPORTS: All tables 60" and longer will be fitted with a v-shaped, 14 gauge steel keel. All tables 48" wide and 60" long and longer will be fitted with two parallel steel keels.</p> <p>LEG ASSEMBLY: Legs are 2 3/8" x 2 3/8" glued up solid stock. The two inside edges are tapered down to 1 1/2" x 1 1/2". The leg is attached to a 5" x 5" x 1/4" thick steel plate by means of two threaded machine bolts fastened to a barrel nut embedded in the leg. Two steel decorative angle bars are attached to the upper outside corners of the leg spaced 5" apart. Plate and leg assembly shall be mounted to the underside of the table top by means of threaded inserts embedded in the underside of the top. Inserts are capable of receiving machine bolts.</p> <p>WORK SURFACE HEIGHT: Table heights of 25" (children), 27" (youth), and 32" (wheelchair) are available by request.</p>
	EL-R42		42"	42"	29"	90 Lbs.	8 Cu Ft	\$ 2,950	
	EL-R48		48"	48"	29"	100 Lbs.	10 Cu Ft	\$ 3,031	
	EL-R60		60"	60"	29"	155 Lbs.	10 Cu Ft	\$ 3,488	
	EL-4242	Square Reading Tables	42"	42"	29"	170 Lbs.	8 Cu Ft	\$ 2,888	
	EL-4848		48"	48"	29"	230 Lbs.	10 Cu Ft	\$ 2,963	
	EL-6036	60" Wide Rectangle Reading Tables	60"	36"	29"	200 Lbs.	10 Cu Ft	\$ 3,069	
	EL-6048		60"	48"	29"	270 Lbs.	13 Cu Ft	\$ 3,250	
	EL-7236	72" Wide Rectangle Reading Tables	72"	36"	29"	230 Lbs.	12 Cu Ft	\$ 3,150	
	EL-7248		72"	48"	29"	290 Lbs.	15 Cu Ft	\$ 3,344	
	EL-8436	84" Wide Rectangle Reading Tables	84"	36"	29"	290 Lbs.	13 Cu Ft	\$ 3,231	
	EL-8448		84"	48"	29"	290 Lbs.	18 Cu Ft	\$ 3,444	
EL-9636	96" Wide Rectangle Reading Tables	96"	36"	29"	290 Lbs.	15 Cu Ft	\$ 3,306		
EL-9648		96"	48"	29"	340 Lbs.	20 Cu Ft	\$ 3,538		

	MODEL NUMBER	PRODUCT	W	D	H	WEIGHT	VOLUME	LIST PRICE	DESCRIPTION
	FS-AS	Atlas Stand	31"	28"	43"	170 Lbs.	32 Cu Ft	\$ 4,200	<p>TOP: Sloped top is constructed of 1 1/4" thick 3-ply particleboard core. Top surface is laminated with a .050" thick high pressure plastic laminate sheet and bottom surface laminated with a backing sheet not less than .020" thick for balanced construction. Surrounding edges will be banded with a 3/4" wide x 1 1/4" thick solid hardwood external edge, mitered and radiused to 1/2" at the top and eased at the bottom and fitted with a wood book rail 5/8" thick x 5/8" wide.</p> <p>CONSTRUCTION ASSEMBLY: Cabinet construction consists of a 3/4" thick 3-ply particleboard core sides with plain sliced veneer both faces, a 1/2" thick back, five 3/4" thick 3-ply particleboard core pull-out shelves with 3/4" thick x 1 3/4" high solid wood retainer lip operating on bottom mounted single extension drawer runners.</p> <p>END PANELS: Panel frame construction consists of a 1 1/16" thick 3-ply particleboard core with plain sliced veneer both faces 1 3/4" thick x 2 1/2" wide solid hardwood framed on four sides and three inset 1/2" thick x 1 3/4" wide solid vertical pilasters. All edges of panel frame and pilasters are eased.</p>

MODEL NUMBER	PRODUCT	W	D	H	WEIGHT	VOLUME	LIST PRICE	DESCRIPTION	
	FS-DC	Dictionary Stand	26 ³ / ₄ "	19"	42"	70 Lbs.	15 Cu Ft	\$ 2,988	<p>TOP: Sloped top is constructed of 1¹/₄" thick 3-ply particleboard core. Top surface is laminated with a .050" thick high pressure plastic laminate sheet and bottom surface laminated with a backing sheet not less than .020" thick for balanced construction. Surrounding edges will be banded with a ³/₄" wide x 1¹/₄" thick solid hardwood external edge, mitered and radiused to ¹/₂" at the top and eased at the bottom and fitted with a wood book rail ⁵/₈" thick x ⁵/₈" wide.</p> <p>CONSTRUCTION ASSEMBLY: Cabinet construction consists of ³/₄" thick 3-ply particleboard core sides with plain sliced veneer both faces, a ¹/₄" thick back, a ³/₄" thick 3-ply particleboard core adjustable shelf and a ¹/₁₆" thick 3-ply particleboard core bottom.</p> <p>END PANELS: Panel construction consists of a ¹/₁₆" thick 3-ply particleboard core with plain sliced veneer both faces and ¹/₄" thick solid top and bottom edge. Front and back edge machined to receive 1¹/₂" x 1¹/₂" tubular, 16 gauge steel posts.</p>

	MODEL NUMBER	PRODUCT	W	D	H	WEIGHT	VOLUME	LIST PRICE	DESCRIPTION
	FS-DP	Display Table	31 1/2"	63 1/2"	39"	180 Lbs.	40 Cu Ft	\$ 7,756	<p>DISPLAY CASE CONSTRUCTION: Wood frame is constructed of 1 1/2" thick x 1 1/2" wide solid hardwood with 1/4" thick glass on all 4 sides and top with all edges eased. One long back side of the case is equipped with sliding glass doors complete with lock. Display case size: 30" deep x 62" wide x 10" high.</p> <p>WORK SURFACE: Tops are constructed of 1 1/4" thick 3-ply particleboard core. Top surface is laminated with a .050" thick high pressure plastic laminate sheet and bottom surface laminated with a backing sheet not less than .020" thick for balanced construction. Work surface edge is 3/4" thick x 1 1/4" solid external hardwood edge, mitered and radiused 1/2" at the top and eased at the bottom.</p> <p>FRAME ASSEMBLY: Each frame assembly shall consist of two steel legs and a top horizontal stretcher constructed of 2" x 2" tubular 16 gauge steel. All welds and grinds will be smooth. Two 2" x 2" tubular 16 gauge stretchers will be mechanically fastened to each end frame assembly by means of bolt assembly. The top corners of each frame shall be fitted with a 3/4" diameter steel pentel and is mechanically fastened to a 5" x 5" steel plate creating a 2" floating effect.</p>

MODEL NUMBER

PRODUCT

W

D

H

WEIGHT

VOLUME

LIST PRICE

DESCRIPTION



Single Face Modular Carrels

Version 1:

- FS-SC-V1-36-SS 36" Starter
- FS-SC-V1-36-SA 36" Adder
- FS-SC-V1-48-SS 48" Starter
- FS-SC-V1-48-SA 48" Adder

- 36" Starter
- 36" Adder
- 48" Starter
- 48" Adder

- 37 1/2"
- 36"
- 49 1/2"
- 48"

- 31"
- 31"
- 31"
- 31"

- 36"
- 36"
- 36"
- 36"

- 180 Lbs.
- 130 Lbs.
- 200 Lbs.
- 160 Lbs.

- 10 Cu Ft
- 7 Cu Ft
- 11 Cu Ft
- 8 Cu Ft

- \$ 2,819
- \$ 2,500
- \$ 2,925
- \$ 2,600

WORK SURFACE:

Tops are constructed of 1 1/4" thick 3-ply particleboard core. Top surface is laminated with a .050" thick high pressure plastic laminate sheet and bottom surface laminated with a backing sheet not less than .020" thick for balanced construction. Front work surface edge is 3/4" thick x 1 1/4" high solid external hardwood with 1/2" radius at the top and eased at the bottom. Work surface is 28" deep x 29" high.

END AND MID PANELS:

Panel construction consists of a 1 1/16" thick 3-ply particleboard core with plain sliced veneer both faces and 1/4" thick solid top and bottom edge. Front and back edge machined to receive 1 1/2" x 1 1/2" tubular, 16 gauge steel posts.

BACK PANEL:

Back is constructed of 1 1/16" thick 3-ply particleboard core with plain sliced veneer both faces, 1/4" solid hardwood at top and bottom with eased edges.



Double Face Modular Carrels

Version 1:

- FS-SC-V1-36-DS 36" Starter
- FS-SC-V1-36-DA 36" Adder
- FS-SC-V1-48-DS 48" Starter
- FS-SC-V1-48-DA 48" Adder

- 36" Starter
- 36" Adder
- 48" Starter
- 48" Adder

- 37 1/2"
- 36"
- 49 1/2"
- 48"

- 62"
- 62"
- 62"
- 62"

- 36"
- 36"
- 36"
- 36"

- 255 Lbs.
- 160 Lbs.
- 290 Lbs.
- 210 Lbs.

- 14 Cu Ft
- 11 Cu Ft
- 16 Cu Ft
- 12 Cu Ft

- \$ 3,881
- \$ 3,419
- \$ 4,063
- \$ 3,606

MODEL NUMBER	PRODUCT	W	D	H	WEIGHT	VOLUME	LIST PRICE	DESCRIPTION
--------------	---------	---	---	---	--------	--------	------------	-------------



Single Face Modular Carrels

Version 2:



FS-SC-V2-36-SS	36" Starter	37 1/2"	31"	36"	180 Lbs.	10 Cu Ft	\$ 3,150	<p>WORK SURFACE: Tops are constructed of 1 1/4" thick 3-ply particleboard core. Top surface is laminated with a .050" thick high pressure plastic laminate sheet and bottom surface laminated with a backing sheet not less than .020" thick for balanced construction. Front work surface edge is 3/4" thick x 1 1/4" high solid external hardwood with 1/2" radius at the top and eased at the bottom. Work surface is 28" deep x 29" high.</p> <p>END AND MID PANELS: Panel construction consists of a 1 1/16" thick 3-ply particleboard core with plain sliced veneer both faces. Upper portion is fitted with 1/4" thick frosted acrylic screen and 1/4" thick solid bottom edge. Front and back edge machined to receive 1 1/2" x 1 1/2" tubular, 16 gauge steel posts.</p> <p>BACK PANEL: Back is constructed of 1 1/16" thick 3-ply particleboard core with plain sliced veneer both faces, 1/4" solid hardwood at top and bottom with eased edges.</p>
FS-SC-V2-36-SA	36" Adder	36"	31"	36"	130 Lbs.	7 Cu Ft	\$ 2,706	
FS-SC-V2-48-SS	48" Starter	49 1/2"	31"	36"	200 Lbs.	11 Cu Ft	\$ 3,250	
FS-SC-V2-48-SA	48" Adder	48"	31"	36"	160 Lbs.	8 Cu Ft	\$ 2,813	







Double Face Modular Carrels



Version 2:



FS-SC-V2-36-DS	36" Starter	37 1/2"	62"	36"	255 Lbs.	14 Cu Ft	\$ 4,444
FS-SC-V2-36-DA	36" Adder	36"	62"	36"	160 Lbs.	11 Cu Ft	\$ 3,744
FS-SC-V2-48-DS	48" Starter	49 1/2"	62"	36"	290 Lbs.	16 Cu Ft	\$ 4,631
FS-SC-V2-48-DA	48" Adder	48"	62"	36"	210 Lbs.	12 Cu Ft	\$ 3,931



MODEL NUMBER	PRODUCT	W	D	H	WEIGHT	VOLUME	LIST PRICE	DESCRIPTION
		Single Face Modular Carrels Version 3:						
FS-SC-V3-36-SS	36" Starter	37 ¹ / ₂ "	31"	36"	180 Lbs.	10 Cu Ft	\$ 3,269	WORK SURFACE: Tops are constructed of 1 ¹ / ₄ " thick 3-ply particleboard core. Top surface is laminated with a .050" thick high pressure plastic laminate sheet and bottom surface laminated with a backing sheet not less than .020" thick for balanced construction. Front work surface edge is 3 ³ / ₄ " thick x 1 ¹ / ₄ " high solid external hardwood with 1 ¹ / ₂ " radius at the top and eased at the bottom. Work surface is 28" deep x 29" high. END AND MID PANELS: Panel construction consists of a 1 ¹ / ₁₆ " thick 3-ply particleboard core with plain sliced veneer both faces and 1 ¹ / ₄ " thick solid top and bottom edge. Front and back edge machined to receive 1 ¹ / ₂ " x 1 ¹ / ₂ " tubular, 16 gauge steel posts. BACK PANEL: Back is constructed of 3 ³ / ₈ " thick frosted acrylic screen, mechanically fastened to 1 ¹ / ₂ " x 1 ¹ / ₂ " tubular, 16 gauge steel posts.
FS-SC-V3-36-SA	36" Adder	36"	31"	36"	130 Lbs.	7 Cu Ft	\$ 2,831	
FS-SC-V3-48-SS	48" Starter	49 ¹ / ₂ "	31"	36"	200 Lbs.	11 Cu Ft	\$ 3,381	
FS-SC-V3-48-SA	48" Adder	48"	31"	36"	160 Lbs.	8 Cu Ft	\$ 2,944	
		Double Face Modular Carrels Version 3:						
FS-SC-V3-36-DS	36" Starter	37 ¹ / ₂ "	62"	36"	255 Lbs.	14 Cu Ft	\$ 4,569	
FS-SC-V3-36-DA	36" Adder	36"	62"	36"	160 Lbs.	11 Cu Ft	\$ 3,869	
FS-SC-V3-48-DS	48" Starter	49 ¹ / ₂ "	62"	36"	290 Lbs.	16 Cu Ft	\$ 4,763	
FS-SC-V3-48-DA	48" Adder	48"	62"	36"	210 Lbs.	12 Cu Ft	\$ 4,063	

MODEL NUMBER	PRODUCT	W	D	H	WEIGHT	VOLUME	LIST PRICE	DESCRIPTION
	Single Face Reference Carrels:							
	FS-RC-36-SS 36" Starter	37 ¹ / ₂ "	31"	48 ¹ / ₂ "	200 Lbs.	10 Cu Ft	\$ 3,069	<p>WORK SURFACE: Tops are constructed of 1¹/₄" thick 3-ply particleboard core. Top surface is laminated with a .050" thick high pressure plastic laminate sheet and bottom surface laminated with a backing sheet not less than .020" thick for balanced construction. Front work surface edge is 3³/₄" thick x 1¹/₄" high solid external hardwood with 1¹/₂" radius at the top and eased at the bottom. Tops will be set back from the back panel 2" to provide a wire drop and will be fitted with a retainer lip. Work surface is 26" deep and is adjustable at four increments 39", 32", 29" and 27" high.</p> <p>END AND MID PANELS: Panel frame construction consists of a 1¹/₁₆" thick 3-ply particleboard core with plain sliced veneer both faces and 1¹/₄" thick solid top and bottom edge. Front and back edge machined to receive 1¹/₂" x 1¹/₂" tubular, 16 gauge steel posts.</p> <p>BACK PANEL: Back is constructed of 1¹/₁₆" thick 3-ply particleboard core with plain sliced veneer both faces, 1¹/₄" solid hardwood at top and bottom with eased edges.</p> <p>BOTTOM SHELF: Shelf construction consists of 3³/₄" thick 3-ply particleboard core with plain sliced veneer both faces and the front edge is banded with a 1¹/₄" solid external edge. Shelf is 12" deep positioned 21" above the floor.</p>
	FS-RC-36-SA 36" Adder	36 ¹ / ₄ "	31"	48 ¹ / ₂ "	150 Lbs.	7 Cu Ft	\$ 2,719	
	FS-RC-48-SS 48" Starter	49 ¹ / ₄ "	31"	48 ¹ / ₂ "	230 Lbs.	11 Cu Ft	\$ 3,188	
FS-RC-48-SA 48" Adder	48 ¹ / ₄ "	31"	48 ¹ / ₂ "	180 Lbs.	8 Cu Ft	\$ 2,838		
	Double Face Reference Carrels:							
	FS-RC-36-DS 36" Starter	37 ¹ / ₂ "	60 ¹ / ₂ "	48 ¹ / ₂ "	275 Lbs.	14 Cu Ft	\$ 4,188	
	FS-RC-36-DA 36" Adder	36 ¹ / ₄ "	60 ¹ / ₂ "	48 ¹ / ₂ "	180 Lbs.	11 Cu Ft	\$ 3,675	
	FS-RC-48-DS 48" Starter	49 ¹ / ₄ "	60 ¹ / ₂ "	48 ¹ / ₂ "	310 Lbs.	16 Cu Ft	\$ 4,550	
FS-RC-48-DA 48" Adder	48 ¹ / ₄ "	60 ¹ / ₂ "	48 ¹ / ₂ "	230 Lbs.	12 Cu Ft	\$ 4,044		

MODEL NUMBER	PRODUCT	W	D	H	WEIGHT	VOLUME	LIST PRICE	DESCRIPTION	
									
1 Person PAC Tables:									
FS-PAC-1-29-W	Sitting Height, Wood Divider	36"	36"	37"	100 Lbs.	10 Cu Ft	\$ 3,606	<p>WORK SURFACE: Tops are constructed of 1 1/4" thick 3-ply particleboard core. Top surface is laminated with a .050" thick high pressure plastic laminate sheet and bottom surface laminated with a backing sheet not less than .020" thick for balanced construction. Work surface edge is 3/4" thick x 1 1/4" solid external hardwood edge, mitered and radiused 1/2" at the top and eased at the bottom.</p> <p>FRAME ASSEMBLY: Each frame assembly shall consist of two steel legs and a top horizontal stretcher constructed of 2" x 2" tubular 16 gauge steel. All welds and grinds will be smooth. Two 2" x 2" tubular 16 gauge stretchers will be mechanically fastened to each end frame assembly by means of bolt assembly. The top corners of each frame shall be fitted with a 3/4" diameter steel pentel and is mechanically fastened to a 5" x 5" steel plate creating a 2" floating effect.</p> <p>WOOD DIVIDERS: Sloped side dividers constructed of 3/4" thick x 8" high solid hardwood and back divider constructed of 3/4" x 7 3/4" high veneer particleboard, top edge banded with 1/4" external hardwood.</p> <p>ACRYLIC DIVIDERS: Sloped side panels and rectangular back divider consisting of 1/4" thick x 8" high frosted acrylic complete with diameter brushed steel stand-off.</p> <p>WORK SURFACE HEIGHT: Table heights of 25" (children), 27" (youth), and 32" (wheelchair) are available by request.</p> <p>ELECTRICAL ACCESSORIES: Each seating position shall receive a 3" diameter black plastic grommet and a black metal j-channel for wire management.</p>	
FS-PAC-1-29-A	Sitting Height, Acrylic Divider	36"	36"	37"	100 Lbs.	10 Cu Ft	\$ 3,800		
FS-PAC-1-32-W	Wheelchair Height, Wood Divider	36"	36"	40"	100 Lbs.	10 Cu Ft	\$ 3,669		
FS-PAC-1-32-A	Wheelchair Height, Acrylic Divider	36"	36"	40"	100 Lbs.	10 Cu Ft	\$ 3,856		
FS-PAC-1-39-W	Standing Height, Wood Divider	36"	36"	47"	100 Lbs.	10 Cu Ft	\$ 3,725		
FS-PAC-1-39-A	Standing Height, Acrylic Divider	36"	36"	47"	100 Lbs.	10 Cu Ft	\$ 3,913		
									
2 Person (1 Place Back to Back) PAC Tables:									
FS-PAC-1D-29-W	Sitting Height, Wood Divider	36"	48"	37"	100 Lbs.	10 Cu Ft	\$ 3,813		
FS-PAC-1D-29-A	Sitting Height, Acrylic Divider	36"	48"	37"	100 Lbs.	10 Cu Ft	\$ 4,050		
FS-PAC-1D-32-W	Wheelchair Height, Wood Divider	36"	48"	40"	100 Lbs.	10 Cu Ft	\$ 3,869		
FS-PAC-1D-32-A	Wheelchair Height, Acrylic Divider	36"	48"	40"	100 Lbs.	10 Cu Ft	\$ 4,106		
FS-PAC-1D-39-W	Standing Height, Wood Divider	36"	48"	47"	100 Lbs.	10 Cu Ft	\$ 3,925		
FS-PAC-1D-39-A	Standing Height, Acrylic Divider	36"	48"	47"	100 Lbs.	10 Cu Ft	\$ 4,163		

MODEL NUMBER	PRODUCT	W	D	H	WEIGHT	VOLUME	LIST PRICE	DESCRIPTION	
									
2 Person PAC Tables:									
FS-PAC-2-29-W	Sitting Height, Wood Divider	72"	36"	37"	150 Lbs.	21 Cu Ft	\$ 4,238	<p>WORK SURFACE: Tops are constructed of 1 1/4" thick 3-ply particleboard core. Top surface is laminated with a .050" thick high pressure plastic laminate sheet and bottom surface laminated with a backing sheet not less than .020" thick for balanced construction. Work surface edge is 3/4" thick x 1 1/4" solid external hardwood edge, mitered and radiused 1/2" at the top and eased at the bottom.</p> <p>FRAME ASSEMBLY: Each frame assembly shall consist of two steel legs and a top horizontal stretcher constructed of 2" x 2" tubular 16 gauge steel. All welds and grinds will be smooth. Two 2" x 2" tubular 16 gauge stretchers will be mechanically fastened to each end frame assembly by means of bolt assembly. The top corners of each frame shall be fitted with a 3/4" diameter steel pentel and is mechanically fastened to a 5" x 5" steel plate creating a 2" floating effect.</p> <p>WOOD DIVIDERS: Sloped side dividers constructed of 3/4" thick x 8" high solid hardwood and back divider constructed of 3/4" x 7 3/4" high veneer particleboard, top edge banded with 1/4" external hardwood.</p> <p>ACRYLIC DIVIDERS: Sloped side panels and rectangular back divider consisting of 1/4" thick x 8" high frosted acrylic complete with diameter brushed steel stand-off.</p> <p>WORK SURFACE HEIGHT: Table heights of 25" (children), 27" (youth), and 32" (wheelchair) are available by request.</p> <p>ELECTRICAL ACCESSORIES: Each seating position shall receive a 3" diameter black plastic grommet and a black metal j-channel for wire management.</p>	
FS-PAC-2-29-A	Sitting Height, Acrylic Divider	72"	36"	37"	150 Lbs.	21 Cu Ft	\$ 4,831		
FS-PAC-2-32-W	Wheelchair Height, Wood Divider 72"	72"	36"	40"	150 Lbs.	21 Cu Ft	\$ 4,294		
FS-PAC-2-32-A	Wheelchair Height, Acrylic Divider 72"	72"	36"	40"	150 Lbs.	21 Cu Ft	\$ 4,888		
FS-PAC-2-39-W	Standing Height, Wood Divider	72"	36"	47"	150 Lbs.	21 Cu Ft	\$ 4,350		
FS-PAC-2-39-A	Standing Height, Acrylic Divider	72"	36"	47"	150 Lbs.	21 Cu Ft	\$ 4,944		
									
4 Person (2 Place Back to Back) PAC Tables:									
FS-PAC-2D-29-W	Sitting Height, Wood Divider	72"	48"	37"	150 Lbs.	21 Cu Ft	\$ 4,625		
FS-PAC-2D-29-A	Sitting Height, Acrylic Divider	72"	48"	37"	150 Lbs.	21 Cu Ft	\$ 5,188		
FS-PAC-2D-32-W	Wheelchair Height, Wood Divider 72"	72"	48"	40"	150 Lbs.	21 Cu Ft	\$ 4,681		
FS-PAC-2D-32-A	Wheelchair Height, Acrylic Divider 72"	72"	48"	40"	150 Lbs.	21 Cu Ft	\$ 5,244		
FS-PAC-2D-39-W	Standing Height, Wood Divider	72"	48"	47"	150 Lbs.	21 Cu Ft	\$ 4,738		
FS-PAC-2D-39-A	Standing Height, Acrylic Divider	72"	48"	47"	150 Lbs.	21 Cu Ft	\$ 5,300		

MODEL NUMBER	PRODUCT	W	D	H	WEIGHT	VOLUME	LIST PRICE	DESCRIPTION	
									
3 Person PAC Tables:									
FS-PAC-3-29-W	Sitting Height, Wood Divider	90"	36"	37"	185 Lbs.	26 Cu Ft	\$ 4,619	<p>WORK SURFACE: Tops are constructed of 1 1/4" thick 3-ply particleboard core. Top surface is laminated with a .050" thick high pressure plastic laminate sheet and bottom surface laminated with a backing sheet not less than .020" thick for balanced construction. Work surface edge is 3/4" thick x 1 1/4" solid external hardwood edge, mitered and radiused 1/2" at the top and eased at the bottom.</p> <p>FRAME ASSEMBLY: Each frame assembly shall consist of two steel legs and a top horizontal stretcher constructed of 2" x 2" tubular 16 gauge steel. All welds and grinds will be smooth. Two 2" x 2" tubular 16 gauge stretchers will be mechanically fastened to each end frame assembly by means of bolt assembly. The top corners of each frame shall be fitted with a 3/4" diameter steel pentel and is mechanically fastened to a 5" x 5" steel plate creating a 2" floating effect.</p> <p>WOOD DIVIDERS: Sloped side dividers constructed of 3/4" thick x 8" high solid hardwood and back divider constructed of 3/4" x 7 3/4" high veneer particleboard, top edge banded with 1/4" external hardwood.</p> <p>ACRYLIC DIVIDERS: Sloped side panels and rectangular back divider consisting of 1/4" thick x 8" high frosted acrylic complete with diameter brushed steel stand-off.</p> <p>WORK SURFACE HEIGHT: Table heights of 25" (children), 27" (youth), and 32" (wheelchair) are available by request.</p> <p>ELECTRICAL ACCESSORIES: Each seating position shall receive a 3" diameter black plastic grommet and a black metal j-channel for wire management.</p>	
FS-PAC-3-29-A	Sitting Height, Acrylic Divider	90"	36"	37"	185 Lbs.	26 Cu Ft	\$ 5,638		
FS-PAC-3-32-W	Wheelchair Height, Wood Divider	90"	36"	40"	185 Lbs.	26 Cu Ft	\$ 4,675		
FS-PAC-3-32-A	Wheelchair Height, Acrylic Divider	90"	36"	40"	185 Lbs.	26 Cu Ft	\$ 5,694		
FS-PAC-3-39-W	Standing Height, Wood Divider	90"	36"	47"	185 Lbs.	26 Cu Ft	\$ 4,731		
FS-PAC-3-39-A	Standing Height, Acrylic Divider	90"	36"	47"	185 Lbs.	26 Cu Ft	\$ 5,750		
									
6 Person (3 Place Back to Back) PAC Tables:									
FS-PAC-3D-29-W	Sitting Height, Wood Divider	90"	48"	37"	185 Lbs.	26 Cu Ft	\$ 5,069		
FS-PAC-3D-29-A	Sitting Height, Acrylic Divider	90"	48"	37"	185 Lbs.	26 Cu Ft	\$ 6,069		
FS-PAC-3D-32-W	Wheelchair Height, Wood Divider	90"	48"	40"	185 Lbs.	26 Cu Ft	\$ 5,131		
FS-PAC-3D-32-A	Wheelchair Height, Acrylic Divider	90"	48"	40"	185 Lbs.	26 Cu Ft	\$ 6,125		
FS-PAC-3D-39-W	Standing Height, Wood Divider	90"	48"	47"	185 Lbs.	26 Cu Ft	\$ 5,188		
FS-PAC-3D-39-A	Standing Height, Acrylic Divider	90"	48"	47"	185 Lbs.	26 Cu Ft	\$ 6,188		

	MODEL NUMBER	PRODUCT	W	D	H	WEIGHT	VOLUME	LIST PRICE	DESCRIPTION
	FS-R42	Round Reading Tables	42"	42"	29"	90 Lbs.	5 Cu Ft	\$ 3,313	<p>WORK SURFACE: Tops are constructed of 1 1/4" thick 3-ply particleboard core. Top surface is laminated with a .050" thick high pressure plastic laminate sheet and bottom surface laminated with a backing sheet not less than .020" thick for balanced construction. Work surface edge is 3/4" thick x 1 1/4" solid external hardwood edge, mitered and radiused 1/2" at the top and eased at the bottom.</p> <p>FRAME ASSEMBLY: Each frame assembly shall consist of two steel legs and a top horizontal stretcher constructed of 2" x 2" tubular 16 gauge steel. All welds and grinds will be smooth. Two 2" x 2" tubular 16 gauge stretchers will be mechanically fastened to each end frame assembly by means of bolt assembly. The top corners of each frame shall be fitted with a 3/4" diameter steel pentel and is mechanically fastened to a 5" x 5" steel plate creating a 2" floating effect. Table heights of 25" (children), 27" (youth), and 32" (wheelchair) are available by request.</p>
	FS-R48		48"	48"	29"	100 Lbs.	6 Cu Ft	\$ 3,444	
	FS-4242	Square Reading Tables	42"	42"	29"	90 Lbs.	6 Cu Ft	\$ 2,869	
	FS-4848		48"	48"	29"	100 Lbs.	6 Cu Ft	\$ 2,975	
	FS-6036	60" Wide Rectangle Reading Tables	60"	36"	29"	110 Lbs.	7 Cu Ft	\$ 3,238	
	FS-6048		60"	48"	29"	135 Lbs.	9 Cu Ft	\$ 3,363	
	FS-7236	72" Wide Rectangle Reading Tables	72"	36"	29"	125 Lbs.	8 Cu Ft	\$ 3,350	
	FS-7248		72"	48"	29"	160 Lbs.	10 Cu Ft	\$ 3,519	
	FS-8436	84" Wide Rectangle Reading Tables	84"	36"	29"	142 Lbs.	8 Cu Ft	\$ 3,556	
	FS-8448		84"	48"	29"	180 Lbs.	10 Cu Ft	\$ 3,725	
FS-9636	96" Wide Rectangle Reading Tables	96"	36"	29"	140 Lbs.	10 Cu Ft	\$ 3,694		
FS-9648		96"	48"	29"	200 Lbs.	12 Cu Ft	\$ 3,875		



MODEL NUMBER	PRODUCT	W	D	H	WEIGHT	VOLUME	LIST PRICE	DESCRIPTION
PT-NP	Newspaper Table	36"	26"	38"	190 Lbs.	25 Cu Ft	\$ 5,469	<p>TABLE RACK: Open frame construction consists of 7/8" thick x 3" wide solid hardwood, all edges eased with newspaper stick holders fitted on either side of rack to accommodate 10 wood newspaper sticks.</p> <p>END PANELS: Panel frame construction consists of a 2 1/2" thick built-up particleboard core with plain sliced veneer interior face. Front face of panels shall be designed using rift sawn veneers 2" wide running horizontally and vertically around the perimeter meeting at mitered corners. Panels are framed on top and two vertical sides with 1/8" thick x 2 1/2" wide solid hardwood. The center of the panel is routed to accept a 1/8" deep x 3/16" wide solid ebony inlay. Podium base construction consists of a 3" thick built-up particleboard core with 1/4" thick x 4" high solid hardwood mitered corners.</p>



MODEL NUMBER	PRODUCT	W	D	H	WEIGHT	VOLUME	LIST PRICE	DESCRIPTION
PT-AS	Atlas Stand	32 ¹ / ₂ "	29 ¹ / ₂ "	44 ¹ / ₂ "	270 Lbs.	33 Cu Ft	\$ 5,825	<p>TOP: Sloped top is constructed of ³/₄" particleboard core with plastic laminate surfaces and fitted with a wood book rail ⁵/₈" thick x ⁵/₈" wide.</p> <p>CONSTRUCTION ASSEMBLY: Cabinet construction consists of a ³/₄" thick 3-ply particleboard core back with plain sliced veneer both faces, five ³/₄" thick 3-ply particleboard core pull-out shelves with ³/₄" thick x 1³/₄" high solid wood retainer lip operating on bottom mounted single extension drawer runners.</p> <p>END PANELS: Panel frame construction consists of a 2¹/₂" thick built-up particleboard core with plain sliced veneer interior face. Front face of panels shall be designed using rift sawn veneers 2" wide running horizontally and vertically around the perimeter meeting at mitered corners. Panels are framed on top and two vertical sides with ¹/₈" thick x 2¹/₂" wide solid hardwood. The center of the panel is routed to accept a ¹/₈" deep x ³/₁₆" wide solid ebony inlay. Podium base construction consists of a 3" thick built-up particleboard core with ¹/₄" thick x 4" high solid hardwood mitered corners.</p>





MODEL NUMBER	PRODUCT	W	D	H	WEIGHT	VOLUME	LIST PRICE	DESCRIPTION
PT-DC	Dictionary Stand	28 ¹ / ₄ "	16 ³ / ₄ "	44 ¹ / ₂ "	190 Lbs.	16 Cu Ft	\$ 4,219	<p>TOP: Sloped top is constructed of ³/₄" particleboard core with plastic laminate surfaces and fitted with a wood book rail ⁵/₈" thick x ⁵/₈" wide.</p> <p>CONSTRUCTION ASSEMBLY: Cabinet construction consists of a ³/₄" thick 3-ply particleboard core back with plain sliced veneer both faces, a ³/₄" thick 3-ply particleboard core adjustable shelf and a ³/₄" thick 3-ply particleboard core fixed bottom shelf with ³/₄" thick x 1³/₄" high solid wood drop edge.</p> <p>END PANELS: Panel frame construction consists of a 2¹/₂" thick built-up particleboard core with plain sliced veneer interior face. Front face of panels shall be designed using rift sawn veneers 2" wide running horizontally and vertically around the perimeter meeting at mitered corners. Panels are framed on top and two vertical sides with ¹/₈" thick x 2¹/₂" wide solid hardwood. The center of the panel is routed to accept a ¹/₈" deep x ³/₁₆" wide solid ebony inlay. Podium base construction consists of a 3" thick built-up particleboard core with ¹/₄" thick x 4" high solid hardwood mitered corners.</p>









MODEL NUMBER	PRODUCT	W	D	H	WEIGHT	VOLUME	LIST PRICE	DESCRIPTION
PT-DP	Display Table	30 1/2"	62 1/2"	39"	255 Lbs.	23 Cu Ft	\$ 10,863	<p>CASE CONSTRUCTION: Wood framing constructed from 1 1/2" x 1 1/2" solid. Framing to be routed to receive 1/4" thick glass on all four sides. Wood framing shall incorporate glass by means of tongue and groove assembly. All wood edges to be slightly radiused. The back side of the case is equipped with sliding glass doors complete with lock. Case will be fastened to top by means of wood screws.</p>
PT-DP-FB	Display Table Fabric Covered Bottom	30 1/2"	62 1/2"	39"	255 Lbs.	23 Cu Ft	\$ 11,694	<p>Display top shall be constructed of 1 1/4" thick 3-ply particleboard core. Top surface to be laminated with a .050" thick high pressure laminate sheet, bottom surface laminated with a backing sheet not less than .020" thick. The four edges will have a 1/4" thick solid internal band, edges will be banded before the laminate and backer sheets have been applied. All edges shall be eased.</p> <p>TOP SUPPORT: A 2" thick x 6" high solid hardwood keel shall be fitted between the panels and the underside of the top by means of metal key-hole inserts, fasteners and wood screws.</p> <p>PODIUM BASE PANEL: Base panels shall be constructed 3" thick built-up high density particle core, with premium grade "A" face veneers. The panels shall be designed with a 4 1/4" wide x 1/2" deep indentation separating two raised panel faces. The center indentation shall receive a 3/16" thick x 1/8" deep solid black inlay, the inlay will begin and end 2" from the top and bottom. The front panel of each face shall be designed using rift-cut veneers 2" wide running horizontally and vertically around the perimeter of the panel meeting at mitered corners. Panels are framed on four sides with 1/8" thick x 3" wide solid hardwood, having the top and bottom members overlapping the vertical edges. The base shall be constructed in a podium fashion with 1/4" thick x 4" high solid hardwood faces mitered on four sides of the panel and throughout the indentation.</p> <p>GLIDES: The underside of each panel will be routed and countersunk to accept two leveling glides.</p> <p>OPTION: Display table with fabric covered bottom (PR-156-FB)</p>









MODEL NUMBER	PRODUCT	W	D	H	WEIGHT	VOLUME	LIST PRICE	DESCRIPTION
PT-AV	AV Browser	52 1/4"	23 1/2"	42 1/2"	260 Lbs.	37 Cu Ft	\$ 5,463	<p>MULTIMEDIA DISPLAY BIN: Constructed from 3/4" thick 3-ply particleboard core with grade "A" face veneer. Storage bin is divided into 7 compartments each 6 1/4" wide complete with six removable black 1/4" thick masonite dividers. Bottom of bin will be lined with black ribbed rubber. Bin capacity approximately 290 compact discs. Unit may also accommodate tapes.</p> <p>End panels shall be constructed 2 1/2" thick built-up high density particle core, with premium grade "A" face veneers. The front panel face shall be designed using rift-cut veneers 2" wide running horizontally and vertically around the perimeter of the panel meeting at mitered corners. Panels are framed on four sides with 1/8" thick x 2 1/2" wide solid hardwood, having the top and bottom members overlapping the vertical edges. The center of the panel will then be routed to insert a 28" long x 3/16" thick x 1/8" deep solid black inlay. The base shall be constructed in a podium fashion with 1/4" thick x 4" high solid hardwood faces mitered on four sides of the panel. A 2" thick x 6" high solid hardwood keel shall be fitted between the panels by means of metal key-hole inserts and fasteners.</p> <p>GLIDES: The underside of each panel will be routed and countersunk to accept two leveling glides.</p>

	MODEL NUMBER	PRODUCT	W	D	H	WEIGHT	VOLUME	LIST PRICE	DESCRIPTION
	PT-IT-DS-4P	4 Person Index Table Double Sided Double Tier	60"	48"	52 ³ / ₄ "	440 Lbs.	64 Cu Ft	\$ 9,569	<p>SUPERSTRUCTURE: Side panels, mid panels, shelves and back shall be constructed from ³/₄" thick veneer plywood. All edges and corners shall be eased. The top of the side and back panels shall be banded with a ³/₄" thick x 2" high solid, the front and back vertical edges shall be banded with ¹/₈" thick solid hardwood. Side Panels shall be tapered down from a top dimension of 17" wide to 20" wide at the bottom. Rack dimensions shall be 23³/₄" high x 20" deep. The back panel shall be 23⁵/₈" high. The rack shall be inset 1¹/₂" from the side edges and centered on the work surface. The shelves shall be 8¹/₄" deep with premium grade "A" face veneer, the front edge banded with a ¹/₄" solid external hardwood edge. The shelf shall be installed 13" above the work surface. The outside faces of each side panel shall be accentuated with a ³/₁₆" thick x ¹/₈" deep solid black inlay. The inlay will begin 4" below the top edge of the panel and 2" up from the bottom of the panel. The superstructure shall be assembled by means concealed metal key-hole fasteners. Mounted to the work surface by means of wood screws passing through the underside of the top and into the rack.</p> <p>VENEER TOP (OPTION): Top shall constitute the same construction as above only that the work surface will be veneered and finished with a polyurethane finish. The work surface shall be accentuated with a black reveal. A ³/₁₆" black reveal shall be inlayed 7" from the leading edge on either side of the work surface and run horizontally across the table and down the side edges.</p> <p>TOP SUPPORT: A 2" thick x 6" high solid hardwood keel shall be fitted between the panel bases and the underside of the sub-top by means of metal key-hole inserts, fasteners and wood screws.</p> <p>PODIUM END PANEL: Base panels shall be constructed 3" thick built-up high density particle core, with premium grade "A" face veneers. The panels shall be designed with a 4¹/₄" wide x ¹/₂" deep indentation separating two raised panel faces. The center indentation shall receive a ³/₁₆" thick x ¹/₈" deep solid black inlay, the inlay will begin and end 2" from the top and bottom. The front panel of each face shall be designed using rift-cut veneers 2" wide running horizontally and vertically around the perimeter of the panel meeting at mitered corners, thus giving a raised panel effect. Panels are framed on four sides with a ¹/₈" thick x 3" wide solid hardwood, having the top and bottom members overlapping the vertical edges. The base shall be constructed in a podium fashion with ¹/₄" thick x 4" high solid hardwood faces mitered on four sides of the panel and throughout the indentation."</p> <p>GLIDES: The underside of each panel will be routed and countersunk to accept two leveling glides.</p>
	PT-IT-DS-6P	6 Person Index Table Double Sided Double Tier	90"	48"	52 ³ / ₄ "	470 Lbs.	96 Cu Ft	\$ 10,538	

	MODEL NUMBER	PRODUCT	W	D	H	WEIGHT	VOLUME	LIST PRICE	DESCRIPTION
	PT-MC-SS	Single Modular Carrel	35 ³ / ₄ "	26 ¹ / ₂ "	48"	140 Lbs.	16 Cu Ft	\$ 5,956	<p>SUPERSTRUCTURE: Side panels, mid panels, shelves and back shall be constructed from ³/₄" thick veneer plywood. All edges and corners shall be eased. The top of the side and back panels shall be banded with a ³/₄" thick x 2" high solid, the front and back vertical edges shall be banded with ¹/₈" thick solid hardwood. Single face study carrel panels shall be tapered down from a top dimension of 15⁷/₈" wide to 17³/₈" wide at the bottom. Double face carrel panels shall be tapered down from a top dimension of 27" wide to 30" wide at the bottom. Single face rack shall be 19" high x 17³/₈" deep, double face rack shall be 19" high x 30" deep. The back panel for both single and double face units shall be 18⁷/₈" high. The rack on single face units shall be inset 1³/₈" from the back edge and 1¹/₂" from the side edges. The rack on double face units shall be centered on the work surface. The shelf for both single face and double face units shall be 9" deep wit premium grade "A" face veneer, the front edge banded with a ¹/₄" solid external hardwood edge. The shelf shall be installed 15" above the work surface. The outside faces of each side panel shall be accentuated with a ³/₁₆" thick x ¹/₈" deep solid black inlay. The inlay will begin 4" below the top edge of the panel and 2" up from the bottom of the panel. The superstructure shall be assembled by means concealed metal key-hole fasteners. Mounted to the work surface by means of wood screws passing through the underside of the top and into the rack.</p> <p> veneer TOP (OPTION): Top shall constitute the same construction as above only that the work surface will be veneered and finished with a polyurethane finish. The work surface shall be accentuated with a black reveal. A ³/₁₆" black reveal shall be inlaid 7" from the leading edge and run horizontally across the table and down the work surface. Single face units shall receive one reveal inlay and two reveal inlays for double face units.</p> <p>TOP SUPPORT: A 2" thick x 6" high solid hardwood keel shall be fitted between the panel bases and the underside of the sub-top by means of metal key-hole inserts, fasteners and wood screws.</p>
	PT-MC-DS	Double Modular Carrel	35 ³ / ₄ "	48"	48"	210 Lbs.	32 Cu Ft	\$ 9,369	
	PT-MC-Q	Four Place Modular Carrel	70 ¹ / ₂ "	48"	48"	310 Lbs.	62 Cu Ft	\$ 10,138	

	MODEL NUMBER	PRODUCT	W	D	H	WEIGHT	VOLUME	LIST PRICE	DESCRIPTION
	PT-PAC-1-29	1 Person PAC Tables: Sitting Height	36"	36"	37"	135 Lbs.	13 Cu Ft	\$ 5,888	<p>SUPERSTRUCTURE: Side panels, and back shall be constructed from $\frac{3}{4}$" thick solid hardwood. All edges and corners shall be eased. The side panels shall be tapered down from a top dimension of 7" wide to 8" wide at the bottom. Single face rack shall be 8" high x 8" deep, double face rack shall be constructed from $\frac{3}{4}$" thick veneer plywood 8" high x 15" deep. The back panel for both single and double face units shall be $\frac{7}{8}$" high. The rack on single face units shall be inset $1\frac{3}{8}$" from the back edge and $1\frac{1}{2}$" from the side edges. The rack on double face units shall be centered on the work surface.</p> <p>VENEER TOP (OPTION): Top shall constitute the same construction as above only that the work surface will be veneered and finished with a polyurethane finish. The work surface shall be accentuated with a black reveal. A $\frac{3}{16}$" black reveal shall be inlaid 7" from the leading edge and run horizontally across the table and down the work surface. Single face units shall receive one reveal inlay and two reveal inlays for double face units.</p> <p>TOP SUPPORT: A 2" thick x 6" high solid hardwood keel shall be fitted between the panel bases and the underside of the sub-top by means of metal key-hole inserts, fasteners and wood screws.</p> <p>PODIUM END PANEL - SINGLE FACE PAC: Base panels shall be constructed $2\frac{1}{2}$" thick built-up high density particle core, with premium grade "A" face veneers. The front panel face shall be designed using rift-cut veneers 2" wide running horizontally and vertically around the perimeter of the panel meeting at mitered corners, thus giving a raised panel effect. Panels are framed on four sides with $\frac{1}{8}$" thick x $2\frac{1}{2}$" wide solid hardwood, having the top and bottom members overlapping the vertical edges. The center of the panel will then be routed to insert a $14\frac{1}{4}$" long x $\frac{3}{16}$" thick x $\frac{1}{8}$" deep solid black inlay. The base shall be constructed in a podium fashion with $\frac{1}{4}$" thick x 4" high solid hardwood faces mitered on four sides of the panel. A 2" thick x 6" high solid hardwood keel shall be fitted between the panels by means of metal key-hole inserts and fasteners.</p>
	PT-PAC-1-32	Wheelchair Accessible	36"	36"	40"	135 Lbs.	16 Cu Ft	\$ 5,913	
	PT-PAC-1-39	Standing Height	36"	36"	47"	140 Lbs.	23 Cu Ft	\$ 5,988	
	PT-PAC-2-29	2 Person PAC Tables: Sitting Height	72"	36"	37"	205 Lbs.	27 Cu Ft	\$ 6,338	
	PT-PAC-2-32	Wheelchair Accessible	72"	36"	40"	205 Lbs.	33 Cu Ft	\$ 6,369	
	PT-PAC-2-39	Standing Height	72"	36"	47"	210 Lbs.	46 Cu Ft	\$ 6,438	
	PT-PAC-3-29	3 Person PAC Tables: Sitting Height	90"	36"	37"	260 Lbs.	34 Cu Ft	\$ 6,850	
	PT-PAC-3-32	Wheelchair Accessible	90"	36"	40"	260 Lbs.	41 Cu Ft	\$ 6,881	
	PT-PAC-3-39	Standing Height	90"	36"	47"	270 Lbs.	58 Cu Ft	\$ 6,950	

MODEL NUMBER	PRODUCT	W	D	H	WEIGHT	VOLUME	LIST PRICE	DESCRIPTION	
	2 Person (1 Place Back to Back) PAC Tables:							<p>SUPERSTRUCTURE: Side panels, and back shall be constructed from 3/4" thick solid hardwood. All edges and corners shall be eased. The side panels shall be tapered down from a top dimension of 7" wide to 8" wide at the bottom. Single face rack shall be 8" high x 8" deep, double face rack shall be constructed from 3/4" thick veneer plywood 8" high x 15" deep. The back panel for both single and double face units shall be 7 7/8" high. The rack on single face units shall be inset 1 3/8" from the back edge and 1 1/2" from the side edges. The rack on double face units shall be centered on the work surface.</p> <p>VENEER TOP (OPTION): Top shall constitute the same construction as above only that the work surface will be veneered and finished with a polyurethane finish. The work surface shall be accentuated with a black reveal. A 3/16" black reveal shall be inlaid 7" from the leading edge and run horizontally across the table and down the work surface. Single face units shall receive one reveal inlay and two reveal inlays for double face units.</p> <p>TOP SUPPORT: A 2" thick x 6" high solid hardwood keel shall be fitted between the panel bases and the underside of the sub-top by means of metal key-hole inserts, fasteners and wood screws.</p> <p>PODIUM END PANEL - SINGLE FACE PAC: Base panels shall be constructed 2 1/2" thick built-up high density particle core, with premium grade "A" face veneers. The front panel face shall be designed using rift-cut veneers 2" wide running horizontally and vertically around the perimeter of the panel meeting at mitered corners, thus giving a raised panel effect. Panels are framed on four sides with 1/8" thick x 2 1/2" wide solid hardwood, having the top and bottom members overlapping the vertical edges. The center of the panel will then be routed to insert a 14 1/4" long x 3/16" thick x 1/8" deep solid black inlay. The base shall be constructed in a podium fashion with 1/4" thick x 4" high solid hardwood faces mitered on four sides of the panel. A 2" thick x 6" high solid hardwood keel shall be fitted between the panels by means of metal key-hole inserts and fasteners.</p> <p>PODIUM END PANEL - DOUBLE FACE PAC: Base panels shall be constructed 3" thick built-up high density particle core, with premium grade "A" face veneers. The panels shall be designed with a 4 1/4" wide x 1/2" deep indentation separating two raised panel faces. The center indentation shall receive a 3/16" thick x 1/8" deep solid black inlay, the inlay will begin and end 2" from the top and bottom. The front panel of each face shall be designed using rift-cut veneers 2" wide running horizontally and vertically around the perimeter of the panel meeting at mitered corners, thus giving a raised panel effect. Panels are framed on four sides with a 1/8" thick x 3" wide solid hardwood, having the top and bottom members overlapping the vertical edges. The base shall be constructed in a podium fashion with 1/4" thick x 4" high solid hardwood faces mitered on four sides of the panel and throughout the indentation.</p>	
	PT-PAC-1D-29	Sitting Height	36"	60"	37"	260 Lbs.	22 Cu Ft		\$ 9,263
	PT-PAC-1D-32	Wheelchair Accessible	36"	60"	40"	260 Lbs.	27 Cu Ft		\$ 9,313
PT-PAC-1D-39	Standing Height	36"	60"	47"	270 Lbs.	38 Cu Ft	\$ 9,444		
	4 Person (2 Place Back to Back) PAC Tables:							<p>SUPERSTRUCTURE: Side panels, and back shall be constructed from 3/4" thick solid hardwood. All edges and corners shall be eased. The side panels shall be tapered down from a top dimension of 7" wide to 8" wide at the bottom. Single face rack shall be 8" high x 8" deep, double face rack shall be constructed from 3/4" thick veneer plywood 8" high x 15" deep. The back panel for both single and double face units shall be 7 7/8" high. The rack on single face units shall be inset 1 3/8" from the back edge and 1 1/2" from the side edges. The rack on double face units shall be centered on the work surface.</p> <p>VENEER TOP (OPTION): Top shall constitute the same construction as above only that the work surface will be veneered and finished with a polyurethane finish. The work surface shall be accentuated with a black reveal. A 3/16" black reveal shall be inlaid 7" from the leading edge and run horizontally across the table and down the work surface. Single face units shall receive one reveal inlay and two reveal inlays for double face units.</p> <p>TOP SUPPORT: A 2" thick x 6" high solid hardwood keel shall be fitted between the panel bases and the underside of the sub-top by means of metal key-hole inserts, fasteners and wood screws.</p> <p>PODIUM END PANEL - SINGLE FACE PAC: Base panels shall be constructed 2 1/2" thick built-up high density particle core, with premium grade "A" face veneers. The front panel face shall be designed using rift-cut veneers 2" wide running horizontally and vertically around the perimeter of the panel meeting at mitered corners, thus giving a raised panel effect. Panels are framed on four sides with 1/8" thick x 2 1/2" wide solid hardwood, having the top and bottom members overlapping the vertical edges. The center of the panel will then be routed to insert a 14 1/4" long x 3/16" thick x 1/8" deep solid black inlay. The base shall be constructed in a podium fashion with 1/4" thick x 4" high solid hardwood faces mitered on four sides of the panel. A 2" thick x 6" high solid hardwood keel shall be fitted between the panels by means of metal key-hole inserts and fasteners.</p> <p>PODIUM END PANEL - DOUBLE FACE PAC: Base panels shall be constructed 3" thick built-up high density particle core, with premium grade "A" face veneers. The panels shall be designed with a 4 1/4" wide x 1/2" deep indentation separating two raised panel faces. The center indentation shall receive a 3/16" thick x 1/8" deep solid black inlay, the inlay will begin and end 2" from the top and bottom. The front panel of each face shall be designed using rift-cut veneers 2" wide running horizontally and vertically around the perimeter of the panel meeting at mitered corners, thus giving a raised panel effect. Panels are framed on four sides with a 1/8" thick x 3" wide solid hardwood, having the top and bottom members overlapping the vertical edges. The base shall be constructed in a podium fashion with 1/4" thick x 4" high solid hardwood faces mitered on four sides of the panel and throughout the indentation.</p>	
	PT-PAC-2D-29	Sitting Height	72"	60"	37"	400 Lbs.	45 Cu Ft		\$ 10,056
	PT-PAC-2D-32	Wheelchair Accessible	72"	60"	40"	400 Lbs.	54 Cu Ft		\$ 10,106
PT-PAC-2D-39	Standing Height	72"	60"	47"	410 Lbs.	77 Cu Ft	\$ 10,231		
	6 Person (3 Place Back to Back) PAC Tables:							<p>SUPERSTRUCTURE: Side panels, and back shall be constructed from 3/4" thick solid hardwood. All edges and corners shall be eased. The side panels shall be tapered down from a top dimension of 7" wide to 8" wide at the bottom. Single face rack shall be 8" high x 8" deep, double face rack shall be constructed from 3/4" thick veneer plywood 8" high x 15" deep. The back panel for both single and double face units shall be 7 7/8" high. The rack on single face units shall be inset 1 3/8" from the back edge and 1 1/2" from the side edges. The rack on double face units shall be centered on the work surface.</p> <p>VENEER TOP (OPTION): Top shall constitute the same construction as above only that the work surface will be veneered and finished with a polyurethane finish. The work surface shall be accentuated with a black reveal. A 3/16" black reveal shall be inlaid 7" from the leading edge and run horizontally across the table and down the work surface. Single face units shall receive one reveal inlay and two reveal inlays for double face units.</p> <p>TOP SUPPORT: A 2" thick x 6" high solid hardwood keel shall be fitted between the panel bases and the underside of the sub-top by means of metal key-hole inserts, fasteners and wood screws.</p> <p>PODIUM END PANEL - SINGLE FACE PAC: Base panels shall be constructed 2 1/2" thick built-up high density particle core, with premium grade "A" face veneers. The front panel face shall be designed using rift-cut veneers 2" wide running horizontally and vertically around the perimeter of the panel meeting at mitered corners, thus giving a raised panel effect. Panels are framed on four sides with 1/8" thick x 2 1/2" wide solid hardwood, having the top and bottom members overlapping the vertical edges. The center of the panel will then be routed to insert a 14 1/4" long x 3/16" thick x 1/8" deep solid black inlay. The base shall be constructed in a podium fashion with 1/4" thick x 4" high solid hardwood faces mitered on four sides of the panel. A 2" thick x 6" high solid hardwood keel shall be fitted between the panels by means of metal key-hole inserts and fasteners.</p> <p>PODIUM END PANEL - DOUBLE FACE PAC: Base panels shall be constructed 3" thick built-up high density particle core, with premium grade "A" face veneers. The panels shall be designed with a 4 1/4" wide x 1/2" deep indentation separating two raised panel faces. The center indentation shall receive a 3/16" thick x 1/8" deep solid black inlay, the inlay will begin and end 2" from the top and bottom. The front panel of each face shall be designed using rift-cut veneers 2" wide running horizontally and vertically around the perimeter of the panel meeting at mitered corners, thus giving a raised panel effect. Panels are framed on four sides with a 1/8" thick x 3" wide solid hardwood, having the top and bottom members overlapping the vertical edges. The base shall be constructed in a podium fashion with 1/4" thick x 4" high solid hardwood faces mitered on four sides of the panel and throughout the indentation.</p>	
	PT-PAC-3D-29	Sitting Height	90"	60"	37"	500 Lbs.	56 Cu Ft		\$ 10,738
	PT-PAC-3D-32	Wheelchair Accessible	90"	60"	40"	500 Lbs.	68 Cu Ft		\$ 10,788
PT-PAC-3D-39	Standing Height	90"	60"	47"	520 Lbs.	96 Cu Ft	\$ 10,913		

	MODEL NUMBER	PRODUCT	W	D	H	WEIGHT	VOLUME	LIST PRICE	DESCRIPTION
	PT-R42	Round Reading Tables	42"	42"	29"	90 Lbs.	8 Cu Ft	\$ 3,263	<p>APRON: A solid apron base $\frac{3}{4}$" thick x $3\frac{3}{8}$" shall be fitted together by means of metal corner brackets. The underside of the base shall be machined to form an arch beginning 5" from either side and arching in upwards towards the center of the base. The base shall be fastened to the underside of the table top by means of metal "L" brackets and wood screws.</p> <p>TABLE TOP (SQUARE AND RECTANGULAR): Table tops shall be constructed of $1\frac{1}{4}$" thick 3-ply particleboard core. Top surface to be laminated with a .050" thick high pressure plastic laminate sheet, bottom surface laminated with a backing sheet not less than .020" thick for balanced construction. Plastic laminate will meet or exceed NEMA standards. Table edges shall be $2\frac{1}{4}$" wide x $1\frac{5}{8}$" thick solid hardwood. The edge shall be machined in two parts, $\frac{3}{4}$ of the leading edge shall be radiused $\frac{3}{8}$" top and bottom, the remaining solid shall be chamfered inward creating a knife edge detail. The edges shall be mitered at four corners.</p> <p>TABLE TOP (CIRCULAR): Circular tables shall receive a $2\frac{1}{4}$" wide x $1\frac{1}{4}$" thick solid edge band. The edges shall be fabricated in four section. All edges are eased</p> <p>TABLE TOP SUPPORTS: All tables 60" and longer shall be fitted with a V-shaped, 14 gauge steel keel. The keel shall be mounted to the underside of the top by means of wood screws. All tables 48" wide and 60" long and longer shall be fitted with two parallel running steel keels.</p> <p>LEG ASSEMBLY: Legs are $2\frac{3}{8}$" x $2\frac{3}{8}$" glued-up solid stock, all edges eased. Each leg shall receive a $\frac{1}{8}$" x $\frac{1}{8}$" reveal saw cut $2\frac{1}{2}$" from the bottom of the leg. Each leg will be fitted with a hanger bolt which shall pass between the intersecting rails and through the metal corner bracket.</p> <p>GLIDES: Each leg will be fitted with a threaded T-nut to accept a $1\frac{1}{8}$" diameter cushioned glide with a $1" \times \frac{5}{16}$" threaded stem.</p> <p>WORKSURFACE HEIGHT: Standard work surface height shall be 29" high. Optional heights of 32" - wheelchair, 27" and 25" may be specified at no additional upcharge.</p>
	PT-R48		48"	48"	29"	100 Lbs.	10 Cu Ft	\$ 3,419	
	PT-4242	Square Reading Tables	42"	42"	29"	90 Lbs.	8 Cu Ft	\$ 2,744	
	PT-4848		48"	48"	29"	100 Lbs.	10 Cu Ft	\$ 2,913	
	PT-6036	60" Wide Rectangle Reading Tables	60"	36"	29"	170 Lbs.	10 Cu Ft	\$ 3,350	
	PT-6048		60"	48"	29"	230 Lbs.	13 Cu Ft	\$ 3,550	
	PT-7236	72" Wide Rectangle Reading Tables	72"	36"	29"	200 Lbs.	12 Cu Ft	\$ 3,513	
	PT-7248		72"	48"	29"	270 Lbs.	15 Cu Ft	\$ 3,731	
	PT-8436	84" Wide Rectangle Reading Tables	84"	36"	29"	250 Lbs.	13 Cu Ft	\$ 3,681	
PT-8448	84"		48"	29"	280 Lbs.	18 Cu Ft	\$ 3,906		
PT-9636	96" Wide Rectangle Reading Tables	96"	36"	29"	310 Lbs.	15 Cu Ft	\$ 3,844		
PT-9648		96"	48"	29"	320 Lbs.	20 Cu Ft	\$ 4,088		

	MODEL NUMBER	PRODUCT	W	D	H	WEIGHT	VOLUME	LIST PRICE	DESCRIPTION
	PT-6048-PB	60" Wide Rectangle Panel Base Reading Table	60"	48"	29"	250 Lbs.	21 Cu Ft	\$ 7,556	<p>PODIUM BASE PANEL: Base panels shall be constructed 3" thick built-up high density particle core, with premium grade "A" face veneers. The panels shall be designed with a 4¹/₄" wide x 1/2" deep indentation separating two raised panel faces. The center indentation shall receive a 3/16" thick x 1/8" deep solid black inlay, the inlay will begin and end 2" from the top and bottom. The front panel of each face shall be designed using rift-cut veneers 2" wide running horizontally and vertically around the perimeter of the panel meeting at mitered corners, thus giving a raised panel effect. Panels are framed on four sides with 1/8" thick x 3" wide solid hardwood, having the top and bottom members overlapping the vertical edges. The base shall be constructed in a podium fashion with 1/4" thick x 4" high solid hardwood faces mitered on four sides of the panel and throughout the indentation.</p> <p>VENEER TOP (OPTION): Work surface shall constitute the same construction as above only that the top will be veneered and finished with a polyurethane finish. The work surface shall be accentuated with a black reveal. A 3/16" black reveal shall be inlayed 7" from the leading edge and run horizontally across the table and down the top on either side.</p> <p>TOP SUPPORT: A 2" thick x 6" high solid hardwood keel shall be fitted between the panels and the underside of the sub-top by means of metal key-hole inserts, fasteners and wood screws.</p> <p>GLIDES: Each leg will be fitted with a threaded T-nut to accept a 1 1/8" diameter cushioned glide with a 1" x 5/16" threaded stem.</p> <p>WORK SURFACE: Work surface shall be constructed 2" thick built-up high density particle core. Work surface to be laminated with a .050" thick high pressure laminate sheet, bottom surface laminated with a backing sheet not less than .020" thick. The two long horizontal edges of the work surface shall be banded with a 2" wide x 2" thick solid external edge. The edge shall be machined inward creating a chamfered knife edge detail. The finished edge shall be 3/4" thick at the leading edge and 2" thick at the back. The top and bottom of the leading edge shall be radiused 3/16". The two short vertical edges shall be externally banded with 1/8" thick x 2" high solid hardwood. Edges shall be banded to top after the top and bottom laminate sheets have been applied. The tapered edges of the work surface shall extend 8 3/4" beyond the table bases. A 3/4" thick sub-top shall be incorporated into the construction and assembly of the top and the base panels. The sub-top shall be fastened to the top by means of wood screws passing through the sub-top and into the work surface.</p> <p>WORK SURFACE HEIGHT: Standard work surface height shall be 29" high. Optional heights of 32" - wheelchair, 27" and 25" may be specified at no additional upcharge</p>
	PT-7248-PB	72" Wide Rectangle Panel Base Reading Table	72"	48"	29"	310 Lbs.	30 Cu Ft	\$ 7,663	
	PT-8448-PB	84" Wide Rectangle Panel Base Reading Table	84"	48"	29"	250 Lbs.	21 Cu Ft	\$ 8,038	
	PT-9648-PB	96" Wide Rectangle Panel Base Reading Table	96"	48"	29"	330 Lbs.	34 Cu Ft	\$ 8,144	











MODEL NUMBER	PRODUCT	W	D	H	WEIGHT	VOLUME	LIST PRICE	DESCRIPTION
VT-AS	Atlas Stand	30 ¹ / ₂ "	29"	44 ¹ / ₂ "	260 Lbs.	30 Cu Ft	\$ 5,150	<p>CONSTRUCTION ASSEMBLY: A ³/₄" thick particleboard core back complete with grade "A" veneer faces shall be attached to the end panels by means of hidden key-hole fasteners. The top will be fastened to the end panels and back by means of male and female beta clips. The unit will accommodate five pull-out shelves operating on blum slides. Shelves will be constructed of ³/₄" thick plywood with grade "A" veneer faces and the front edge banded with a ³/₄" thick x 1³/₄" high solid retainer lip.</p> <p>Sloped top assembly shall be constructed from ³/₄" thick high density particleboard core, assembled by means of tongue and groove. All surfaces of top to be laminated with a .050" thick laminate. Top will be fitted with a book support rail ⁵/₈" thick x ⁵/₈" deep.</p> <p>END PANEL FRAME ASSEMBLY: End panels shall be constructed 1³/₄" thick, consisting of a 1¹/₄" thick 3-ply particleboard core with plain sliced veneer both faces. Panels are framed on four sides with 1³/₄" thick x 2¹/₂" wide solid hardwood, having the top and bottom members overlapping the vertical frames. The panel will then be fitted with three ⁵/₈" thick x 2" wide solid vertical pilasters inset with the top and bottom solid frame members. All edges of panel frame and pilasters will be eased.</p> <p>GLIDES: Each leg will be fitted with a threaded T-nut to accept a 1¹/₈" diameter cushioned glide with a 1" x ⁵/₁₆" threaded stem.</p>



















MODEL NUMBER	PRODUCT	W	D	H	WEIGHT	VOLUME	LIST PRICE	DESCRIPTION
VT-DC	Dictionary Stand	27 ¹ / ₂ "	21"	44 ¹ / ₂ "	180 Lbs.	20 Cu Ft	\$ 4,013	<p>CONSTRUCTION ASSEMBLY: A ³/₄" thick particleboard core back complete with grade "A" veneer faces shall be attached to the end panels by means of hidden key-hole fasteners. The top will be fastened to the end panels and back by means of male and female beta clips. Unit will come complete with one shelf and a fixed bottom, constructed from ³/₄" thick plywood with grade "A" veneer on both faces, front edge of shelf banded with a ¹/₄" thick solid hardwood. Shelf will be adjustable on 1¹/₄" increments. The fixed bottom shelf will have a ³/₄" x 1³/₄" drop edge mounted to the front edge.</p> <p>Sloped top assembly shall be constructed from ³/₄" thick high density particleboard core, assembled by means of tongue and groove. All surfaces of top to be laminated with a .050" thick laminate. Top will be fitted with a book support rail ⁵/₈" thick x ⁵/₈" deep.</p> <p>END PANEL FRAME ASSEMBLY: End panels shall be constructed 1³/₄" thick, consisting of a 1¹/₄" thick 3-ply particleboard core with plain sliced veneer both faces. Panels are framed on four sides with 1³/₄" thick x 2¹/₂" wide solid hardwood, having the top and bottom members overlapping the vertical frames. The panel will then be fitted with three ⁵/₈" thick x 2" wide solid vertical pilasters inset with the top and bottom solid frame members. All edges of panel frame and pilasters will be eased.</p> <p>GLIDES: Each leg will be fitted with a threaded T-nut to accept a 1¹/₈" diameter cushioned glide with a 1" x ⁵/₁₆" threaded stem.</p>



















MODEL NUMBER	PRODUCT	W	D	H	WEIGHT	VOLUME	LIST PRICE	DESCRIPTION
VT-DP	Display Table	30 1/2"	62 1/2"	39"	245 Lbs.	23 Cu Ft	\$ 8,400	<p>CASE CONSTRUCTION: Wood framing constructed from 1 1/2" x 1 1/2" solid. Framing to be routed to receive 1/4" thick glass on all four sides. Wood framing shall incorporate glass by means of tongue and groove assembly. All wood edges to be slightly radiused. The back side of the case is equipped with sliding glass doors complete with lock. Case will be fastened to top by means of wood screws.</p> <p>TOP: Display top shall be constructed of 1 1/4" thick 3-ply particleboard core. Top surface to be laminated with a .050" thick high pressure laminate sheet, bottom surface laminated with a backing sheet not less than .020" thick for balanced construction. The two long edges shall receive a 3/4" x 1 5/8" solid external hardwood edge. Edges shall be applied to top after the top and bottom laminate sheets have been applied. Top shall receive a 1/32" V-groove detail where laminate and solid meet.</p> <p>TOP SUPPORT: The top will be fitted with a 6" high x 1" thick wood keel. The keel shall be mounted to the underside of the top and fastened to the end panels by means of wood cleats and screws.</p> <p>END PANEL FRAME ASSEMBLY: End panels shall be constructed 1 3/4" thick, consisting of a 1 1/4" thick 3-ply particleboard core with plain sliced veneer both faces. Panels are framed on four sides with 1 3/4" thick x 2 1/2" wide solid hardwood, having the top and bottom members overlapping the vertical frames. The panel will then be fitted with three 5/8" thick x 2" wide solid vertical pilasters inset with the top and bottom solid frame members. All edges of panel frame and pilasters will be eased. Panels will be fastened to top by means of solid hardwood cleats.</p> <p>GLIDES: Each leg will be fitted with a threaded T-nut to accept a 1 1/8" diameter cushioned glide with a 1" x 5/16" threaded stem.</p> <p>OPTION: Fabric bottom</p>
VT-DP-FB	Display Table with Fabric Covered Bottom	30 1/2"	62 1/2"	39"	245 Lbs.	23 Cu Ft	\$ 9,231	



MODEL NUMBER	PRODUCT	W	D	H	WEIGHT	VOLUME	LIST PRICE	DESCRIPTION	
	Single Face Study Carrel Version 1, 36" High:	VT-SC-V1-36-SS	36" Starter	38 ¹ / ₂ "	31"	36"	340 Lbs.	11 Cu Ft	\$ 3,994
		VT-SC-V1-36-SA	36" Adder	36 ³ / ₄ "	31"	36"			\$ 3,269
		VT-SC-V1-48-SS	48" Starter	50 ¹ / ₂ "	31"	36"	340 Lbs.	11 Cu Ft	\$ 4,069
		VT-SC-V1-48-SA	48" Adder	48 ³ / ₄ "	31"	36"			\$ 3,344
	Double Face Study Carrel Version 1, 36" High:	VT-SC-V1-36-DS	36" Starter	38 ¹ / ₂ "	60 ¹ / ₂ "	36"	655 Lbs.	22 Cu Ft	\$ 5,856
		VT-SC-V1-36-DA	36" Adder	36 ³ / ₄ "	60 ¹ / ₂ "	36"			\$ 4,719
		VT-SC-V1-48-DS	48" Starter	50 ¹ / ₂ "	60 ¹ / ₂ "	36"	710 Lbs.	22 Cu Ft	\$ 5,963
		VT-SC-V1-48-DA	48" Adder	48 ³ / ₄ "	60 ¹ / ₂ "	36"			\$ 4,825
	Single Face Modular Carrel Version 1, 48" High:	VT-MC-V1-36-SS	36" Starter	38 ¹ / ₂ "	31"	48"	340 Lbs.	11 Cu Ft	\$ 4,438
		VT-MC-V1-36-SA	36" Adder	36 ³ / ₄ "	31"	48"			\$ 3,581
		VT-MC-V1-48-SS	48" Starter	50 ¹ / ₂ "	31"	48"	340 Lbs.	11 Cu Ft	\$ 4,513
		VT-MC-V1-48-SA	48" Adder	48 ³ / ₄ "	31"	48"			\$ 3,650
	Double Face Modular Carrel Version 1, 48" High:	VT-MC-V1-36-DS	36" Starter	38 ¹ / ₂ "	60 ¹ / ₂ "	48"	655 Lbs.	22 Cu Ft	\$ 6,475
		VT-MC-V1-36-DA	36" Adder	36 ³ / ₄ "	60 ¹ / ₂ "	48"			\$ 5,106
		VT-MC-V1-48-DS	48" Starter	50 ¹ / ₂ "	60 ¹ / ₂ "	48"	710 Lbs.	22 Cu Ft	\$ 6,588
		VT-MC-V1-48-DA	48" Adder	48 ³ / ₄ "	60 ¹ / ₂ "	48"			\$ 5,225



MODEL NUMBER	PRODUCT	W	D	H	WEIGHT	VOLUME	LIST PRICE	DESCRIPTION	
	Single Face Study Carrel Version 2, 36" High:	VT-SC-V2-36-SS	36" Starter	38 1/2"	31"	36"	340 Lbs.	11 Cu Ft	\$ 3,950
		VT-SC-V2-36-SA	36" Adder	36 3/4"	31"	36"			\$ 3,238
		VT-SC-V2-48-SS	48" Starter	50 1/2"	31"	36"	340 Lbs.	11 Cu Ft	\$ 4,031
		VT-SC-V2-48-SA	48" Adder	48 3/4"	31"	36"			\$ 3,313
	Double Face Study Carrel Version 2, 36" High:	VT-SC-V2-36-DS	36" Starter	38 1/2"	60 1/2"	36"	655 Lbs.	22 Cu Ft	\$ 5,775
		VT-SC-V2-36-DA	36" Adder	36 3/4"	60 1/2"	36"			\$ 4,581
		VT-SC-V2-48-DS	48" Starter	50 1/2"	60 1/2"	36"	710 Lbs.	22 Cu Ft	\$ 5,881
		VT-SC-V2-48-DA	48" Adder	48 3/4"	60 1/2"	36"			\$ 4,688
	Single Face Modular Carrel Version 2, 48" High:	VT-MC-V2-36-SS	36" Starter	38 1/2"	31"	48"	340 Lbs.	11 Cu Ft	\$ 4,394
		VT-MC-V2-36-SA	36" Adder	36 3/4"	31"	48"			\$ 3,550
		VT-MC-V2-48-SS	48" Starter	50 1/2"	31"	48"	340 Lbs.	11 Cu Ft	\$ 4,469
		VT-MC-V2-48-SA	48" Adder	48 3/4"	31"	48"			\$ 3,625
	Double Face Modular Carrel Version 2, 48" High:	VT-MC-V2-36-DS	36" Starter	38 1/2"	60 1/2"	48"	655 Lbs.	22 Cu Ft	\$ 6,394
		VT-MC-V2-36-DA	36" Adder	36 3/4"	60 1/2"	48"			\$ 4,969
		VT-MC-V2-48-DS	48" Starter	50 1/2"	60 1/2"	48"	710 Lbs.	22 Cu Ft	\$ 6,506
		VT-MC-V2-48-DA	48" Adder	48 3/4"	60 1/2"	48"			\$ 5,081



MODEL NUMBER	PRODUCT	W	D	H	WEIGHT	VOLUME	LIST PRICE	DESCRIPTION	
	Single Face Study Carrel Version 3, 36" High:	VT-SC-V3-36-SS	36" Starter	38 ¹ / ₂ "	31"	36"	340 Lbs.	11 Cu Ft	\$ 3,794
		VT-SC-V3-36-SA	36" Adder	36 ³ / ₄ "	31"	36"			\$ 3,119
		VT-SC-V3-48-SS	48" Starter	50 ¹ / ₂ "	31"	36"	340 Lbs.	11 Cu Ft	\$ 3,869
		VT-SC-V3-48-SA	48" Adder	48 ³ / ₄ "	31"	36"			\$ 3,194
	Double Face Study Carrel Version 3, 36" High:	VT-SC-V3-36-DS	36" Starter	38 ¹ / ₂ "	60 ¹ / ₂ "	36"	655 Lbs.	22 Cu Ft	\$ 5,456
		VT-SC-V3-36-DA	36" Adder	36 ³ / ₄ "	60 ¹ / ₂ "	36"			\$ 4,419
		VT-SC-V3-48-DS	48" Starter	50 ¹ / ₂ "	60 ¹ / ₂ "	36"	710 Lbs.	22 Cu Ft	\$ 5,563
		VT-SC-V3-48-DA	48" Adder	48 ³ / ₄ "	60 ¹ / ₂ "	36"			\$ 4,525
	Single Face Modular Carrel Version 3, 48" High:	VT-MC-V3-36-SS	36" Starter	38 ¹ / ₂ "	31"	48"	340 Lbs.	11 Cu Ft	\$ 4,250
		VT-MC-V3-36-SA	36" Adder	36 ³ / ₄ "	31"	48"			\$ 3,444
		VT-MC-V3-48-SS	48" Starter	50 ¹ / ₂ "	31"	48"	340 Lbs.	11 Cu Ft	\$ 4,325
		VT-MC-V3-48-SA	48" Adder	48 ³ / ₄ "	31"	48"			\$ 3,519
	Double Face Modular Carrel Version 3, 48" High:	VT-MC-V3-36-DS	36" Starter	38 ¹ / ₂ "	60 ¹ / ₂ "	48"	655 Lbs.	22 Cu Ft	\$ 6,100
		VT-MC-V3-36-DA	36" Adder	36 ³ / ₄ "	60 ¹ / ₂ "	48"			\$ 4,819
		VT-MC-V3-48-DS	48" Starter	50 ¹ / ₂ "	60 ¹ / ₂ "	48"	710 Lbs.	22 Cu Ft	\$ 6,219
		VT-MC-V3-48-DA	48" Adder	48 ³ / ₄ "	60 ¹ / ₂ "	48"			\$ 4,938



MODEL NUMBER	PRODUCT	W	D	H	WEIGHT	VOLUME	LIST PRICE	DESCRIPTION	
	Single Face Study Carrel Version 4, 36" High:	VT-SC-V4-36-SS	36" Starter	38 ¹ / ₂ "	31"	36"	340 Lbs.	11 Cu Ft	\$ 3,894
		VT-SC-V4-36-SA	36" Adder	36 ³ / ₄ "	31"	36"			\$ 3,169
		VT-SC-V4-48-SS	48" Starter	50 ¹ / ₂ "	31"	36"	340 Lbs.	11 Cu Ft	\$ 3,975
		VT-SC-V4-48-SA	48" Adder	48 ³ / ₄ "	31"	36"			\$ 3,244
	Double Face Study Carrel Version 4, 36" High:	VT-SC-V4-36-DS	36" Starter	38 ¹ / ₂ "	60 ¹ / ₂ "	36"	655 Lbs.	22 Cu Ft	\$ 5,663
		VT-SC-V4-36-DA	36" Adder	36 ³ / ₄ "	60 ¹ / ₂ "	36"			\$ 4,519
		VT-SC-V4-48-DS	48" Starter	50 ¹ / ₂ "	60 ¹ / ₂ "	36"	710 Lbs.	22 Cu Ft	\$ 5,769
		VT-SC-V4-48-DA	48" Adder	48 ³ / ₄ "	60 ¹ / ₂ "	36"			\$ 4,625
	Single Face Modular Carrel Version 4, 48" High:	VT-MC-V4-36-SS	36" Starter	38 ¹ / ₂ "	31"	48"	340 Lbs.	11 Cu Ft	\$ 4,350
		VT-MC-V4-36-SA	36" Adder	36 ³ / ₄ "	31"	48"			\$ 3,494
		VT-MC-V4-48-SS	48" Starter	50 ¹ / ₂ "	31"	48"	340 Lbs.	11 Cu Ft	\$ 4,425
		VT-MC-V4-48-SA	48" Adder	48 ³ / ₄ "	31"	48"			\$ 3,569
	Double Face Modular Carrel Version 4, 48" High:	VT-MC-V4-36-DS	36" Starter	38 ¹ / ₂ "	60 ¹ / ₂ "	48"	655 Lbs.	22 Cu Ft	\$ 6,306
		VT-MC-V4-36-DA	36" Adder	36 ³ / ₄ "	60 ¹ / ₂ "	48"			\$ 4,938
		VT-MC-V4-48-DS	48" Starter	50 ¹ / ₂ "	60 ¹ / ₂ "	48"	710 Lbs.	22 Cu Ft	\$ 6,419
		VT-MC-V4-48-DA	48" Adder	48 ³ / ₄ "	60 ¹ / ₂ "	48"			\$ 5,050



MODEL NUMBER	PRODUCT	W	D	H	WEIGHT	VOLUME	LIST PRICE	DESCRIPTION	
	Single Face Study Carrel Version 5, 36" High:	VT-SC-V5-36-SS	36" Starter	38 ¹ / ₂ "	31"	36"	340 Lbs.	11 Cu Ft	\$ 3,888
		VT-SC-V5-36-SA	36" Adder	36 ³ / ₄ "	31"	36"			\$ 3,163
		VT-SC-V5-48-SS	48" Starter	50 ¹ / ₂ "	31"	36"	340 Lbs.	11 Cu Ft	\$ 3,969
		VT-SC-V5-48-SA	48" Adder	48 ³ / ₄ "	31"	36"			\$ 3,244
	Double Face Study Carrel Version 5, 36" High:	VT-SC-V5-36-DS	36" Starter	38 ¹ / ₂ "	60 ¹ / ₂ "	36"	655 Lbs.	22 Cu Ft	\$ 5,656
		VT-SC-V5-36-DA	36" Adder	36 ³ / ₄ "	60 ¹ / ₂ "	36"			\$ 4,519
		VT-SC-V5-48-DS	48" Starter	50 ¹ / ₂ "	60 ¹ / ₂ "	36"	710 Lbs.	22 Cu Ft	\$ 5,763
		VT-SC-V5-48-DA	48" Adder	48 ³ / ₄ "	60 ¹ / ₂ "	36"			\$ 4,625
	Single Face Modular Carrel Version 5, 48" High:	VT-MC-V5-36-SS	36" Starter	38 ¹ / ₂ "	31"	48"	340 Lbs.	11 Cu Ft	\$ 4,331
		VT-MC-V5-36-SA	36" Adder	36 ³ / ₄ "	31"	48"			\$ 3,475
		VT-MC-V5-48-SS	48" Starter	50 ¹ / ₂ "	31"	48"	340 Lbs.	11 Cu Ft	\$ 4,406
		VT-MC-V5-48-SA	48" Adder	48 ³ / ₄ "	31"	48"			\$ 3,550
	Double Face Modular Carrel Version 5, 48" High:	VT-MC-V5-36-DS	36" Starter	38 ¹ / ₂ "	60 ¹ / ₂ "	48"	655 Lbs.	22 Cu Ft	\$ 6,275
		VT-MC-V5-36-DA	36" Adder	36 ³ / ₄ "	60 ¹ / ₂ "	48"			\$ 4,906
		VT-MC-V5-48-DS	48" Starter	50 ¹ / ₂ "	60 ¹ / ₂ "	48"	710 Lbs.	22 Cu Ft	\$ 6,388
		VT-MC-V5-48-DA	48" Adder	48 ³ / ₄ "	60 ¹ / ₂ "	48"			\$ 5,019



	MODEL NUMBER	PRODUCT	W	D	H	WEIGHT	VOLUME	LIST PRICE	DESCRIPTION
	VT-PAC-1-V1-29	1 Person PAC Table, Version 1: Sitting Height	37 ¹ / ₂ "	36"	37"	130 Lbs.	13 Cu Ft	\$ 5,056	
	VT-PAC-1-V1-32	Wheelchair Accessible	37 ¹ / ₂ "	36"	40"	130 Lbs.	16 Cu Ft	\$ 5,113	
	VT-PAC-1-V1-39	Standing Height	37 ¹ / ₂ "	36"	47"	135 Lbs.	23 Cu Ft	\$ 5,250	
	VT-PAC-2-V1-29	2 Person PAC Table, Version 1: Sitting Height	73 ¹ / ₂ "	36"	37"	200 Lbs.	27 Cu Ft	\$ 5,975	
	VT-PAC-2-V1-32	Wheelchair Accessible	73 ¹ / ₂ "	36"	40"	200 Lbs.	33 Cu Ft	\$ 6,038	
	VT-PAC-2-V1-39	Standing Height	73 ¹ / ₂ "	36"	47"	205 Lbs.	46 Cu Ft	\$ 6,169	
	VT-PAC-3-V1-29	3 Person PAC Table, Version 1: Sitting Height	91 ¹ / ₂ "	36"	37"	250 Lbs.	34 Cu Ft	\$ 6,588	
	VT-PAC-3-V1-32	Wheelchair Accessible	91 ¹ / ₂ "	36"	40"	250 Lbs.	41 Cu Ft	\$ 6,644	
	VT-PAC-3-V1-39	Standing Height	91 ¹ / ₂ "	36"	47"	260 Lbs.	58 Cu Ft	\$ 6,781	



	MODEL NUMBER	PRODUCT	W	D	H	WEIGHT	VOLUME	LIST PRICE	DESCRIPTION
	VT-PAC-1-V2-29	1 Person PAC Table, Version 2: Sitting Height	37 ¹ / ₂ "	36"	37"	130 Lbs.	13 Cu Ft	\$ 4,950	
	VT-PAC-1-V2-32	Wheelchair Accessible	37 ¹ / ₂ "	36"	40"	130 Lbs.	16 Cu Ft	\$ 4,963	
	VT-PAC-1-V2-39	Standing Height	37 ¹ / ₂ "	36"	47"	135 Lbs.	23 Cu Ft	\$ 5,000	
	VT-PAC-2-V2-29	2 Person PAC Table, Version 2: Sitting Height	73 ¹ / ₂ "	36"	37"	200 Lbs.	27 Cu Ft	\$ 5,869	
	VT-PAC-2-V2-32	Wheelchair Accessible	73 ¹ / ₂ "	36"	40"	200 Lbs.	33 Cu Ft	\$ 5,881	
	VT-PAC-2-V2-39	Standing Height	73 ¹ / ₂ "	36"	47"	205 Lbs.	46 Cu Ft	\$ 5,919	
	VT-PAC-3-V2-29	3 Person PAC Table, Version 2: Sitting Height	91 ¹ / ₂ "	36"	37"	250 Lbs.	34 Cu Ft	\$ 6,481	
	VT-PAC-3-V2-32	Wheelchair Accessible	91 ¹ / ₂ "	36"	40"	250 Lbs.	41 Cu Ft	\$ 6,494	
	VT-PAC-3-V2-39	Standing Height	91 ¹ / ₂ "	36"	47"	260 Lbs.	58 Cu Ft	\$ 6,531	



	MODEL NUMBER	PRODUCT	W	D	H	WEIGHT	VOLUME	LIST PRICE	DESCRIPTION
	VT-PAC-1-V3-29	1 Person PAC Table, Version 3: Sitting Height	37 ¹ / ₂ "	36"	37"	130 Lbs.	13 Cu Ft	\$ 4,794	
	VT-PAC-1-V3-32	Wheelchair Accessible	37 ¹ / ₂ "	36"	40"	130 Lbs.	16 Cu Ft	\$ 4,806	
	VT-PAC-1-V3-39	Standing Height	37 ¹ / ₂ "	36"	47"	135 Lbs.	23 Cu Ft	\$ 4,819	
	VT-PAC-2-V3-29	2 Person PAC Table, Version 3: Sitting Height	73 ¹ / ₂ "	36"	37"	200 Lbs.	27 Cu Ft	\$ 5,713	
	VT-PAC-2-V3-32	Wheelchair Accessible	73 ¹ / ₂ "	36"	40"	200 Lbs.	33 Cu Ft	\$ 5,725	
	VT-PAC-2-V3-39	Standing Height	73 ¹ / ₂ "	36"	47"	205 Lbs.	46 Cu Ft	\$ 5,738	
	VT-PAC-3-V3-29	3 Person PAC Table, Version 3: Sitting Height	91 ¹ / ₂ "	36"	37"	250 Lbs.	34 Cu Ft	\$ 6,325	
	VT-PAC-3-V3-32	Wheelchair Accessible	91 ¹ / ₂ "	36"	40"	250 Lbs.	41 Cu Ft	\$ 6,338	
	VT-PAC-3-V3-39	Standing Height	91 ¹ / ₂ "	36"	47"	260 Lbs.	58 Cu Ft	\$ 6,350	



	MODEL NUMBER	PRODUCT	W	D	H	WEIGHT	VOLUME	LIST PRICE	DESCRIPTION
	VT-PAC-1-V4-29	1 Person PAC Table, Version 4: Sitting Height	37 ¹ / ₂ "	36"	37"	130 Lbs.	13 Cu Ft	\$ 4,894	
	VT-PAC-1-V4-32	Wheelchair Accessible	37 ¹ / ₂ "	36"	40"	130 Lbs.	16 Cu Ft	\$ 4,906	
	VT-PAC-1-V4-39	Standing Height	37 ¹ / ₂ "	36"	47"	135 Lbs.	23 Cu Ft	\$ 4,919	
	VT-PAC-2-V4-29	2 Person PAC Table, Version 4: Sitting Height	73 ¹ / ₂ "	36"	37"	200 Lbs.	27 Cu Ft	\$ 5,813	
	VT-PAC-2-V4-32	Wheelchair Accessible	73 ¹ / ₂ "	36"	40"	200 Lbs.	33 Cu Ft	\$ 5,825	
	VT-PAC-2-V4-39	Standing Height	73 ¹ / ₂ "	36"	47"	205 Lbs.	46 Cu Ft	\$ 5,838	
	VT-PAC-3-V4-29	3 Person PAC Table, Version 4: Sitting Height	91 ¹ / ₂ "	36"	37"	250 Lbs.	34 Cu Ft	\$ 6,425	
	VT-PAC-3-V4-32	Wheelchair Accessible	91 ¹ / ₂ "	36"	40"	250 Lbs.	41 Cu Ft	\$ 6,438	
	VT-PAC-3-V4-39	Standing Height	91 ¹ / ₂ "	36"	47"	260 Lbs.	58 Cu Ft	\$ 6,450	



	MODEL NUMBER	PRODUCT	W	D	H	WEIGHT	VOLUME	LIST PRICE	DESCRIPTION
	VT-PAC-1-V5-29	1 Person PAC Table, Version 5: Sitting Height	37 1/2"	36"	37"	130 Lbs.	13 Cu Ft	\$ 4,969	
	VT-PAC-1-V5-32	Wheelchair Accessible	37 1/2"	36"	40"	130 Lbs.	16 Cu Ft	\$ 4,988	
	VT-PAC-1-V5-39	Standing Height	37 1/2"	36"	47"	135 Lbs.	23 Cu Ft	\$ 5,038	
	VT-PAC-2-V5-29	2 Person PAC Table, Version 5: Sitting Height	73 1/2"	36"	37"	200 Lbs.	27 Cu Ft	\$ 5,888	
	VT-PAC-2-V5-32	Wheelchair Accessible	73 1/2"	36"	40"	200 Lbs.	33 Cu Ft	\$ 5,906	
	VT-PAC-2-V5-39	Standing Height	73 1/2"	36"	47"	205 Lbs.	46 Cu Ft	\$ 5,956	
	VT-PAC-3-V5-29	3 Person PAC Table, Version 5: Sitting Height	91 1/2"	36"	37"	250 Lbs.	34 Cu Ft	\$ 6,500	
	VT-PAC-3-V5-32	Wheelchair Accessible	91 1/2"	36"	40"	250 Lbs.	41 Cu Ft	\$ 6,519	
	VT-PAC-3-V5-39	Standing Height	91 1/2"	36"	47"	260 Lbs.	58 Cu Ft	\$ 6,569	



	MODEL NUMBER	PRODUCT	W	D	H	WEIGHT	VOLUME	LIST PRICE	DESCRIPTION
	VT-R42	Round Reading Table	42" Dia.		29"	90 Lbs.	8 Cu Ft	\$ 2,669	
	VT-R48		48" Dia.		29"	100 Lbs.	10 Cu Ft	\$ 2,813	
	VT-4242	Square Reading Table	42"	42"	29"	170 Lbs.	8 Cu Ft	\$ 3,156	
	VT-4848		48"	48"	29"	230 Lbs.	10 Cu Ft	\$ 3,388	



	MODEL NUMBER	PRODUCT	W	D	H	WEIGHT	VOLUME	LIST PRICE	DESCRIPTION
	VT-V1-6036	Rectangle Reading Table, Version 1	60"	36"	29"	200 Lbs.	10 Cu Ft	\$ 4,231	
	VT-V1-6048		60"	48"	29"	270 Lbs.	13 Cu Ft	\$ 4,569	
	VT-V1-7236		72"	36"	29"	230 Lbs.	12 Cu Ft	\$ 4,444	
	VT-V1-7248		72"	48"	29"	290 Lbs.	15 Cu Ft	\$ 4,800	
	VT-V1-8436		84"	36"	29"	290 Lbs.	13 Cu Ft	\$ 4,688	
	VT-V1-8448		84"	48"	29"	290 Lbs.	18 Cu Ft	\$ 5,069	
	VT-V1-9636		96"	36"	29"	290 Lbs.	15 Cu Ft	\$ 4,900	
	VT-V1-9648		96"	48"	29"	340 Lbs.	20 Cu Ft	\$ 5,300	
	VT-V1R-6036	Rectangle Reading Table With Rail, Version 1	60"	36"	29"	200 Lbs.	10 Cu Ft	\$ 4,419	
	VT-V1R-6048		60"	48"	29"	270 Lbs.	13 Cu Ft	\$ 4,756	
	VT-V1R-7236		72"	36"	29"	230 Lbs.	12 Cu Ft	\$ 4,681	
	VT-V1R-7248		72"	48"	29"	290 Lbs.	15 Cu Ft	\$ 5,031	
	VT-V1R-8436		84"	36"	29"	290 Lbs.	13 Cu Ft	\$ 4,963	
	VT-V1R-8448		84"	48"	29"	290 Lbs.	18 Cu Ft	\$ 5,344	
	VT-V1R-9636		96"	36"	29"	290 Lbs.	15 Cu Ft	\$ 5,225	
	VT-V1R-9648		96"	48"	29"	340 Lbs.	20 Cu Ft	\$ 5,619	



	MODEL NUMBER	PRODUCT	W	D	H	WEIGHT	VOLUME	LIST PRICE	DESCRIPTION
	VT-V2-6036	Rectangle Reading Table, Version 2	60"	36"	29"	200 Lbs.	10 Cu Ft	\$ 4,119	
	VT-V2-6048		60"	48"	29"	270 Lbs.	13 Cu Ft	\$ 4,500	
	VT-V2-7236		72"	36"	29"	230 Lbs.	12 Cu Ft	\$ 4,338	
	VT-V2-7248		72"	48"	29"	290 Lbs.	15 Cu Ft	\$ 4,738	
	VT-V2-8436		84"	36"	29"	290 Lbs.	13 Cu Ft	\$ 4,575	
	VT-V2-8448		84"	48"	29"	290 Lbs.	18 Cu Ft	\$ 5,000	
	VT-V2-9636		96"	36"	29"	290 Lbs.	15 Cu Ft	\$ 4,794	
	VT-V2-9648		96"	48"	29"	340 Lbs.	20 Cu Ft	\$ 5,238	
	VT-V2R-6036	Rectangle Reading Table With Rail, Version 2	60"	36"	29"	200 Lbs.	10 Cu Ft	\$ 4,306	
	VT-V2R-6048		60"	48"	29"	270 Lbs.	13 Cu Ft	\$ 4,694	
	VT-V2R-7236		72"	36"	29"	230 Lbs.	12 Cu Ft	\$ 4,569	
	VT-V2R-7248		72"	48"	29"	290 Lbs.	15 Cu Ft	\$ 4,969	
	VT-V2R-8436		84"	36"	29"	290 Lbs.	13 Cu Ft	\$ 4,681	
	VT-V2R-8448		84"	48"	29"	290 Lbs.	18 Cu Ft	\$ 5,275	
	VT-V2R-9636		96"	36"	29"	290 Lbs.	15 Cu Ft	\$ 5,113	
	VT-V2R-9648		96"	48"	29"	340 Lbs.	20 Cu Ft	\$ 5,556	

	MODEL NUMBER	PRODUCT	W	D	H	WEIGHT	VOLUME	LIST PRICE	DESCRIPTION
	VT-V3-6036	Rectangle Reading Table, Version 3	60"	36"	29"	200 Lbs.	10 Cu Ft	\$ 3,963	
	VT-V3-6048		60"	48"	29"	270 Lbs.	13 Cu Ft	\$ 4,306	
	VT-V3-7236		72"	36"	29"	230 Lbs.	12 Cu Ft	\$ 4,181	
	VT-V3-7248		72"	48"	29"	290 Lbs.	15 Cu Ft	\$ 4,538	
	VT-V3-8436		84"	36"	29"	290 Lbs.	13 Cu Ft	\$ 4,419	
	VT-V3-8448		84"	48"	29"	290 Lbs.	18 Cu Ft	\$ 4,800	
	VT-V3-9636		96"	36"	29"	290 Lbs.	15 Cu Ft	\$ 4,638	
	VT-V3-9648		96"	48"	29"	340 Lbs.	20 Cu Ft	\$ 5,038	
	VT-V3R-6036	Rectangle Reading Table With Rail, Version 3	60"	36"	29"	200 Lbs.	10 Cu Ft	\$ 4,150	
	VT-V3R-6048		60"	48"	29"	270 Lbs.	13 Cu Ft	\$ 4,494	
	VT-V3R-7236		72"	36"	29"	230 Lbs.	12 Cu Ft	\$ 4,413	
	VT-V3R-7248		72"	48"	29"	290 Lbs.	15 Cu Ft	\$ 4,769	
	VT-V3R-8436		84"	36"	29"	290 Lbs.	13 Cu Ft	\$ 4,700	
	VT-V3R-8448		84"	48"	29"	290 Lbs.	18 Cu Ft	\$ 5,075	
	VT-V3R-9636		96"	36"	29"	290 Lbs.	15 Cu Ft	\$ 4,956	
	VT-V3R-9648		96"	48"	29"	340 Lbs.	20 Cu Ft	\$ 5,356	



	MODEL NUMBER	PRODUCT	W	D	H	WEIGHT	VOLUME	LIST PRICE	DESCRIPTION
	VT-V4-6036	Rectangle Reading Table, Version 4	60"	36"	29"	200 Lbs.	10 Cu Ft	\$ 4,063	
	VT-V4-6048		60"	48"	29"	270 Lbs.	13 Cu Ft	\$ 4,450	
	VT-V4-7236		72"	36"	29"	230 Lbs.	12 Cu Ft	\$ 4,281	
	VT-V4-7248		72"	48"	29"	290 Lbs.	15 Cu Ft	\$ 4,681	
	VT-V4-8436		84"	36"	29"	290 Lbs.	13 Cu Ft	\$ 4,519	
	VT-V4-8448		84"	48"	29"	290 Lbs.	18 Cu Ft	\$ 4,944	
	VT-V4-9636		96"	36"	29"	290 Lbs.	15 Cu Ft	\$ 4,738	
	VT-V4-9648		96"	48"	29"	340 Lbs.	20 Cu Ft	\$ 5,181	
	VT-V4R-6036	Rectangle Reading Table With Rail, Version 4	60"	36"	29"	200 Lbs.	10 Cu Ft	\$ 4,250	
	VT-V4R-6048		60"	48"	29"	270 Lbs.	13 Cu Ft	\$ 4,638	
	VT-V4R-7236		72"	36"	29"	230 Lbs.	12 Cu Ft	\$ 4,513	
	VT-V4R-7248		72"	48"	29"	290 Lbs.	15 Cu Ft	\$ 4,913	
	VT-V4R-8436		84"	36"	29"	290 Lbs.	13 Cu Ft	\$ 4,800	
	VT-V4R-8448		84"	48"	29"	290 Lbs.	18 Cu Ft	\$ 5,225	
	VT-V4R-9636		96"	36"	29"	290 Lbs.	15 Cu Ft	\$ 5,056	
	VT-V4R-9648		96"	48"	29"	340 Lbs.	20 Cu Ft	\$ 5,500	



	MODEL NUMBER	PRODUCT	W	D	H	WEIGHT	VOLUME	LIST PRICE	DESCRIPTION
	VT-V5-6036	Rectangle Reading Table, Version 5	60"	36"	29"	200 Lbs.	10 Cu Ft	\$ 4,138	
	VT-V5-6048		60"	48"	29"	270 Lbs.	13 Cu Ft	\$ 4,519	
	VT-V5-7236		72"	36"	29"	230 Lbs.	12 Cu Ft	\$ 4,356	
	VT-V5-7248		72"	48"	29"	290 Lbs.	15 Cu Ft	\$ 4,756	
	VT-V5-8436		84"	36"	29"	290 Lbs.	13 Cu Ft	\$ 4,594	
	VT-V5-8448		84"	48"	29"	290 Lbs.	18 Cu Ft	\$ 5,019	
	VT-V5-9636		96"	36"	29"	290 Lbs.	15 Cu Ft	\$ 4,813	
	VT-V5-9648		96"	48"	29"	340 Lbs.	20 Cu Ft	\$ 5,256	
	VT-V5R-6036	Rectangle Reading Table With Rail, Version 5	60"	36"	29"	200 Lbs.	10 Cu Ft	\$ 4,325	
	VT-V5R-6048		60"	48"	29"	270 Lbs.	13 Cu Ft	\$ 4,713	
	VT-V5R-7236		72"	36"	29"	230 Lbs.	12 Cu Ft	\$ 4,588	
	VT-V5R-7248		72"	48"	29"	290 Lbs.	15 Cu Ft	\$ 4,988	
	VT-V5R-8436		84"	36"	29"	290 Lbs.	13 Cu Ft	\$ 4,869	
	VT-V5R-8448		84"	48"	29"	290 Lbs.	18 Cu Ft	\$ 5,294	
	VT-V5R-9636		96"	36"	29"	290 Lbs.	15 Cu Ft	\$ 5,131	
	VT-V5R-9648		96"	48"	29"	340 Lbs.	20 Cu Ft	\$ 5,575	

	MODEL NUMBER	PRODUCT	W	D	H	EDGE	WEIGHT	VOLUME	LIST PRICE	DESCRIPTION
	LX-200-32-SO	Open Shelf Unit	36"	27"	32"	Square	225 Lbs.	30 Cu Ft	\$ 3,025	Unit complete with fixed bottom 39" high unit has two adjustable shelves. 32" high unit complete with one adjustable shelf.
	LX-200-39-SO		36"	27"	39"	Square	225 Lbs.	30 Cu Ft	\$ 3,025	
	LX-200-32-CH	Open Shelf Unit	36"	27"	32"	Chamfered	225 Lbs.	30 Cu Ft	\$ 3,113	
	LX-200-39-CH		36"	27"	39"	Chamfered	225 Lbs.	30 Cu Ft	\$ 3,113	
	LX-200-32-BN	Open Shelf Unit	36"	27"	32"	Bullnose	225 Lbs.	30 Cu Ft	\$ 3,113	
	LX-200-39-BN		36"	27"	39"	Bullnose	225 Lbs.	30 Cu Ft	\$ 3,113	
	LX-201-32-SO	Cupboard Unit	36"	27"	32"	Square	225 Lbs.	30 Cu Ft	\$ 3,769	Doors function on chrome piano hinges complete with lock. 39" high unit comes complete with two adjustable shelves. 32" high unit receives one adjustable shelf.
	LX-201-39-SO		36"	27"	39"	Square	225 Lbs.	30 Cu Ft	\$ 3,769	
	LX-201-32-CH	Cupboard Unit	36"	27"	32"	Chamfered	225 Lbs.	30 Cu Ft	\$ 3,856	
	LX-201-39-CH		36"	27"	39"	Chamfered	225 Lbs.	30 Cu Ft	\$ 3,856	
	LX-201-32-BN	Cupboard Unit	36"	27"	32"	Bullnose	225 Lbs.	30 Cu Ft	\$ 3,856	
	LX-201-39-BN		36"	27"	39"	Bullnose	225 Lbs.	30 Cu Ft	\$ 3,856	

	MODEL NUMBER	PRODUCT	W	D	H	EDGE	WEIGHT	VOLUME	LIST PRICE	DESCRIPTION
	LX-202T-32-SQ	Closed Triangular Corner Unit	27"	27"	32"	Square	150 Lbs.	25 Cu Ft	\$ 3,694	Triangular closed faced corner unit. Unit is used to form a 90 degree angle in a circulation desk configuration.
	LX-202T-39-SQ		27"	27"	39"	Square	150 Lbs.	25 Cu Ft	\$ 3,694	
	LX-202T-32-CH	27"	27"	32"	Chamfered	150 Lbs.	25 Cu Ft	\$ 3,781		
	LX-202T-39-CH	27"	27"	39"	Chamfered	150 Lbs.	25 Cu Ft	\$ 3,781		
	LX-202T-32-BN	27"	27"	32"	Bullnose	150 Lbs.	25 Cu Ft	\$ 3,781		
	LX-202T-39-BN	27"	27"	39"	Bullnose	150 Lbs.	25 Cu Ft	\$ 3,781		
	LX-202C-32-SQ	Closed Curved Corner Unit	27"	27"	32"	Square	150 Lbs.	25 Cu Ft	\$ 3,950	Curved closed unit, used to form a 90 degree angle in a circulation desk configuration.
	LX-202C-39-SQ		27"	27"	39"	Square	150 Lbs.	25 Cu Ft	\$ 3,950	
	LX-202C-32-CH	27"	27"	32"	Chamfered	150 Lbs.	25 Cu Ft	\$ 4,038		
	LX-202C-39-CH	27"	27"	39"	Chamfered	150 Lbs.	25 Cu Ft	\$ 4,038		
	LX-202C-32-BN	27"	27"	32"	Bullnose	150 Lbs.	25 Cu Ft	\$ 4,038		
	LX-202C-39-BN	27"	27"	39"	Bullnose	150 Lbs.	25 Cu Ft	\$ 4,038		
	LX-202S-32-SQ	Closed Square Corner Unit	27"	27"	32"	Square	150 Lbs.	25 Cu Ft	\$ 3,319	Square closed corner unit used to form a 90 degree angle in a circulation desk configuration. Unit complete with closed flush panel design.
	LX-202S-39-SQ		27"	27"	39"	Square	150 Lbs.	25 Cu Ft	\$ 3,319	
	LX-202S-32-CH	27"	27"	32"	Chamfered	150 Lbs.	25 Cu Ft	\$ 3,406		
	LX-202S-39-CH	27"	27"	39"	Chamfered	150 Lbs.	25 Cu Ft	\$ 3,406		
	LX-202S-32-BN	27"	27"	32"	Bullnose	150 Lbs.	25 Cu Ft	\$ 3,406		
	LX-202S-39-BN	27"	27"	39"	Bullnose	150 Lbs.	25 Cu Ft	\$ 3,406		

MODEL NUMBER	PRODUCT	W	D	H	EDGE	WEIGHT	VOLUME	LIST PRICE	DESCRIPTION	
	LX-203-32-SO	Knee Space Unit with Cash and Pencil Drawer	36"	27"	32"	Square	210 Lbs.	30 Cu Ft	\$ 3,613	Unit complete with one pencil drawer, one locking cash drawer and a fixed shelf. Cash drawer will be 5 1/2" high x 12" wide.
	LX-203-39-SO		36"	27"	39"	Square	210 Lbs.	30 Cu Ft	\$ 3,613	
	LX-203-32-CH	36"	27"	32"	Chamfered	210 Lbs.	30 Cu Ft	\$ 3,700		
	LX-203-39-CH	36"	27"	39"	Chamfered	210 Lbs.	30 Cu Ft	\$ 3,700		
	LX-203-32-BN	36"	27"	32"	Bullnose	210 Lbs.	30 Cu Ft	\$ 3,700		
	LX-203-39-BN	36"	27"	39"	Bullnose	210 Lbs.	30 Cu Ft	\$ 3,700		

	MODEL NUMBER	PRODUCT	W	D	H	EDGE	WEIGHT	VOLUME	LIST PRICE	DESCRIPTION
	LX-204-32-SO	Open Triangle Corner Unit	27"	27"	32"	Square	150 Lbs.	25 Cu Ft	\$ 3,306	Triangular open face corner unit is used to form a 90 degree angle in a circulation desk configuration. 39" high unit complete with two adjustable shelves. 32" high unit complete with one adjustable shelf.
	LX-204-39-SO		27"	27"	39"	Square	150 Lbs.	25 Cu Ft	\$ 3,306	
	LX-204-32-CH	27"	27"	32"	Chamfered	150 Lbs.	25 Cu Ft	\$ 3,400		
	LX-204-39-CH	27"	27"	39"	Chamfered	150 Lbs.	25 Cu Ft	\$ 3,400		
	LX-204-32-BN	27"	27"	32"	Bullnose	150 Lbs.	25 Cu Ft	\$ 3,400		
	LX-204-39-BN	27"	27"	39"	Bullnose	150 Lbs.	25 Cu Ft	\$ 3,400		
	LX-204B-32-SO	Open Binder Post Corner Unit	27"	27"	32"	Square	150 Lbs.	25 Cu Ft	\$ 3,756	This unit is an open unit complete with 10 ¹ / ₄ " thick black painted hardboard dividers per shelf, used for storage of binders. Unit also forms a 90 degree angle in a circulation desk configuration.
	LX-204B-39-SO		27"	27"	39"	Square	150 Lbs.	25 Cu Ft	\$ 3,756	
	LX-204B-32-CH	27"	27"	32"	Chamfered	150 Lbs.	25 Cu Ft	\$ 3,844		
	LX-204B-39-CH	27"	27"	39"	Chamfered	150 Lbs.	25 Cu Ft	\$ 3,844		
	LX-204B-32-BN	27"	27"	32"	Bullnose	150 Lbs.	25 Cu Ft	\$ 3,844		
	LX-204B-39-BN	27"	27"	39"	Bullnose	150 Lbs.	25 Cu Ft	\$ 3,844		
	LX-204C-32-SO	Open Curved Corner Unit	27"	27"	32"	Square	150 Lbs.	25 Cu Ft	\$ 3,313	Curved corner unit is used to form a 90 degree angle in a circulation desk configuration. 39" high unit complete with two fixed shelves. 32" high complete with one fixed shelf.
	LX-204C-39-SO		27"	27"	39"	Square	150 Lbs.	25 Cu Ft	\$ 3,313	
	LX-204C-32-CH	27"	27"	32"	Chamfered	150 Lbs.	25 Cu Ft	\$ 3,406		
	LX-204C-39-CH	27"	27"	39"	Chamfered	150 Lbs.	25 Cu Ft	\$ 3,406		
	LX-204C-32-BN	27"	27"	32"	Bullnose	150 Lbs.	25 Cu Ft	\$ 3,406		
	LX-204C-39-BN	27"	27"	39"	Bullnose	150 Lbs.	25 Cu Ft	\$ 3,406		

	MODEL NUMBER	PRODUCT	W	D	H	EDGE	WEIGHT	VOLUME	LIST PRICE	DESCRIPTION
	LX-206-32-SQ	Single Drawer Charge Unit with Shelf	36"	27"	32"	Square	220 Lbs.	30 Cu Ft	\$ 3,600	Unit complete with one single drawer and one adjustable shelf. Drawer will be 5 1/2" high.
	LX-206-39-SQ		36"	27"	39"	Square	220 Lbs.	30 Cu Ft	\$ 3,600	
	LX-206-32-CH	36"	27"	32"	Chamfered	220 Lbs.	30 Cu Ft	\$ 3,688		
	LX-206-39-CH	36"	27"	39"	Chamfered	220 Lbs.	30 Cu Ft	\$ 3,688		
	LX-206-32-BN	36"	27"	32"	Bullnose	220 Lbs.	30 Cu Ft	\$ 3,688		
	LX-206-39-BN	36"	27"	39"	Bullnose	220 Lbs.	30 Cu Ft	\$ 3,688		
	LX-207-32-SQ	Single Drawer Charge Unit	36"	27"	32"	Square	210 Lbs.	30 Cu Ft	\$ 3,513	Unit complete with one single drawer. Drawer will be 5 1/2" high x 20" deep.
	LX-207-39-SQ		36"	27"	39"	Square	210 Lbs.	30 Cu Ft	\$ 3,513	
	LX-207-32-CH	36"	27"	32"	Chamfered	210 Lbs.	30 Cu Ft	\$ 3,600		
	LX-207-39-CH	36"	27"	39"	Chamfered	210 Lbs.	30 Cu Ft	\$ 3,600		
	LX-207-32-BN	36"	27"	32"	Bullnose	210 Lbs.	30 Cu Ft	\$ 3,600		
	LX-207-39-BN	36"	27"	39"	Bullnose	210 Lbs.	30 Cu Ft	\$ 3,600		
	LX-208-32-SQ	Book Return Unit	36"	27"	32"	Square	175 Lbs.	30 Cu Ft	\$ 2,981	Unit will fit a T-100 depressible book truck. (Sold separately) Front panel complete with a 3" high x 14" long slanted book chute. Front edges of chute banded with 1/4" solid hardwood.
	LX-208-39-SQ		36"	27"	39"	Square	175 Lbs.	30 Cu Ft	\$ 2,981	
	LX-208-32-CH	36"	27"	32"	Chamfered	175 Lbs.	30 Cu Ft	\$ 3,069		
	LX-208-39-CH	36"	27"	39"	Chamfered	175 Lbs.	30 Cu Ft	\$ 3,069		
	LX-208-32-BN	36"	27"	32"	Bullnose	175 Lbs.	30 Cu Ft	\$ 3,069		
	LX-208-39-BN	36"	27"	39"	Bullnose	175 Lbs.	30 Cu Ft	\$ 3,069		











MODEL NUMBER	PRODUCT	W	D	H	EDGE	WEIGHT	VOLUME	LIST PRICE	DESCRIPTION
LX-209-3632-SQ	36" Wide Desk Unit with Surround	36"	27"	32"	Square	190 Lbs.	30 Cu Ft	\$ 3,313	Unit is 36", 48", 60" or 72" wide x 27" deep complete with a 29" high work surface. A V-shaped metal keel will be fastened to the underside of the work surface for added support or the 60" and 72" wide units.
LX-209-3639-SQ		36"	27"	39"	Square	190 Lbs.	30 Cu Ft	\$ 3,313	
LX-209-3632-CH	36"	27"	32"	Chamfered	190 Lbs.	30 Cu Ft	\$ 3,400		
LX-209-3639-CH	36"	27"	39"	Chamfered	190 Lbs.	30 Cu Ft	\$ 3,400		
LX-209-3632-BN	36"	27"	32"	Bullnose	190 Lbs.	30 Cu Ft	\$ 3,400		
LX-209-3639-BN	36"	27"	39"	Bullnose	190 Lbs.	30 Cu Ft	\$ 3,400		
LX-209-4832-SQ	48" Wide Desk Unit with Surround	48"	27"	32"	Square	250 Lbs.	40 Cu Ft	\$ 3,438	
LX-209-4839-SQ		48"	27"	39"	Square	250 Lbs.	40 Cu Ft	\$ 3,438	
LX-209-4832-CH	48"	27"	32"	Chamfered	250 Lbs.	40 Cu Ft	\$ 3,556		
LX-209-4839-CH	48"	27"	39"	Chamfered	250 Lbs.	40 Cu Ft	\$ 3,556		
LX-209-4832-BN	48"	27"	32"	Bullnose	250 Lbs.	40 Cu Ft	\$ 3,556		
LX-209-4839-BN	48"	27"	39"	Bullnose	250 Lbs.	40 Cu Ft	\$ 3,556		
LX-209-6032-SQ	60" Wide Desk Unit with Surround	60"	27"	32"	Square	320 Lbs.	50 Cu Ft	\$ 3,669	
LX-209-6039-SQ		60"	27"	39"	Square	320 Lbs.	50 Cu Ft	\$ 3,669	
LX-209-6032-CH	60"	27"	32"	Chamfered	320 Lbs.	50 Cu Ft	\$ 3,819		
LX-209-6039-CH	60"	27"	39"	Chamfered	320 Lbs.	50 Cu Ft	\$ 3,819		
LX-209-6032-BN	60"	27"	32"	Bullnose	320 Lbs.	50 Cu Ft	\$ 3,819		
LX-209-6039-BN	60"	27"	39"	Bullnose	320 Lbs.	50 Cu Ft	\$ 3,819		
LX-209-7232-SQ	72" Wide Desk Unit with Surround	72"	27"	32"	Square	390 Lbs.	60 Cu Ft	\$ 3,794	
LX-209-7239-SQ		72"	27"	39"	Square	390 Lbs.	60 Cu Ft	\$ 3,794	
LX-209-7232-CH	72"	27"	32"	Chamfered	390 Lbs.	60 Cu Ft	\$ 3,969		
LX-209-7239-CH	72"	27"	39"	Chamfered	390 Lbs.	60 Cu Ft	\$ 3,969		
LX-209-7232-BN	72"	27"	32"	Bullnose	390 Lbs.	60 Cu Ft	\$ 3,969		
LX-209-7239-BN	72"	27"	39"	Bullnose	390 Lbs.	60 Cu Ft	\$ 3,969		

	MODEL NUMBER	PRODUCT	W	D	H	EDGE	WEIGHT	VOLUME	LIST PRICE	DESCRIPTION
	LX-209CD-32-SQ	Corner Desk Unit with Surround	65"	29"	32"	Square	500 Lbs.	70 Cu Ft	\$ 4,931	Unit has 27" wide knee space complete with a 29" high work surface and a surround. Corner desk unit is used to form a 90 degree angle in a circulation desk configuration.
	LX-209CD-39-SQ		65"	29"	39"	Square	500 Lbs.	70 Cu Ft	\$ 4,931	
	LX-209CD-32-CH	Corner Desk Unit with Surround	65"	29"	32"	Chamfered	500 Lbs.	70 Cu Ft	\$ 5,194	
	LX-209CD-39-CH		65"	29"	39"	Chamfered	500 Lbs.	70 Cu Ft	\$ 5,194	
	LX-209CD-32-BN	Corner Desk Unit with Surround	65"	29"	32"	Bullnose	500 Lbs.	70 Cu Ft	\$ 5,194	
	LX-209CD-39-BN		65"	29"	39"	Bullnose	500 Lbs.	70 Cu Ft	\$ 5,194	







MODEL NUMBER	PRODUCT	W	D	H	EDGE	WEIGHT	VOLUME	LIST PRICE	DESCRIPTION
LX-219-3632-SQ	36" Wide Desk Unit	36"	27"	32"	Square	190 Lbs.	30 Cu Ft	\$ 2,900	Unit is 36", 48", 60" or 72" wide x 27" deep complete with no surround. A V-shaped metal keel will be fastened to the underside of the work surface for added support on the 60" and 72" wide units.
LX-219-3639-SQ		36"	27"	39"	Square	190 Lbs.	30 Cu Ft	\$ 2,900	
LX-219-3632-CH	36" Wide Desk Unit	36"	27"	32"	Chamfered	190 Lbs.	30 Cu Ft	\$ 2,988	
LX-219-3639-CH		36"	27"	39"	Chamfered	190 Lbs.	30 Cu Ft	\$ 2,988	
LX-219-3632-BN	36" Wide Desk Unit	36"	27"	32"	Bullnose	190 Lbs.	30 Cu Ft	\$ 2,988	
LX-219-3639-BN		36"	27"	39"	Bullnose	190 Lbs.	30 Cu Ft	\$ 2,988	
LX-219-4832-SQ	48" Wide Desk Unit	48"	27"	32"	Square	250 Lbs.	40 Cu Ft	\$ 3,025	
LX-219-4839-SQ		48"	27"	39"	Square	250 Lbs.	40 Cu Ft	\$ 3,025	
LX-219-4832-CH	48" Wide Desk Unit	48"	27"	32"	Chamfered	250 Lbs.	40 Cu Ft	\$ 3,144	
LX-219-4839-CH		48"	27"	39"	Chamfered	250 Lbs.	40 Cu Ft	\$ 3,144	
LX-219-4832-BN	48" Wide Desk Unit	48"	27"	32"	Bullnose	250 Lbs.	40 Cu Ft	\$ 3,144	
LX-219-4839-BN		48"	27"	39"	Bullnose	250 Lbs.	40 Cu Ft	\$ 3,144	
LX-219-6032-SQ	60" Wide Desk Unit	60"	27"	32"	Square	320 Lbs.	50 Cu Ft	\$ 3,256	
LX-219-6039-SQ		60"	27"	39"	Square	320 Lbs.	50 Cu Ft	\$ 3,256	
LX-219-6032-CH	60" Wide Desk Unit	60"	27"	32"	Chamfered	320 Lbs.	50 Cu Ft	\$ 3,400	
LX-219-6039-CH		60"	27"	39"	Chamfered	320 Lbs.	50 Cu Ft	\$ 3,400	
LX-219-6032-BN	60" Wide Desk Unit	60"	27"	32"	Bullnose	320 Lbs.	50 Cu Ft	\$ 3,400	
LX-219-6039-BN		60"	27"	39"	Bullnose	320 Lbs.	50 Cu Ft	\$ 3,400	
LX-219-7232-SQ	72" Wide Desk Unit	72"	27"	32"	Square	390 Lbs.	60 Cu Ft	\$ 3,375	
LX-219-7239-SQ		72"	27"	39"	Square	390 Lbs.	60 Cu Ft	\$ 3,375	
LX-219-7232-CH	72" Wide Desk Unit	72"	27"	32"	Chamfered	390 Lbs.	60 Cu Ft	\$ 3,556	
LX-219-7239-CH		72"	27"	39"	Chamfered	390 Lbs.	60 Cu Ft	\$ 3,556	
LX-219-7232-BN	72" Wide Desk Unit	72"	27"	32"	Bullnose	390 Lbs.	60 Cu Ft	\$ 3,556	
LX-219-7239-BN		72"	27"	39"	Bullnose	390 Lbs.	60 Cu Ft	\$ 3,556	

	MODEL NUMBER	PRODUCT	W	D	H	EDGE	WEIGHT	VOLUME	LIST PRICE	DESCRIPTION
	LX-219CD-32-SQ	Corner Desk Unit	65"	29"	32"	Square	500 Lbs.	70 Cu Ft	\$ 4,413	Unit has 27" wide knee space. Corner desk unit is used to form a 90 degree angle in a circulation desk configuration.
	LX-219CD-39-SQ		65"	29"	39"	Square	500 Lbs.	70 Cu Ft	\$ 4,413	
	LX-219CD-32-CH	Corner Desk Unit	65"	29"	32"	Chamfered	500 Lbs.	70 Cu Ft	\$ 4,681	
	LX-219CD-39-CH		65"	29"	39"	Chamfered	500 Lbs.	70 Cu Ft	\$ 4,681	
	LX-219CD-32-BN	Corner Desk Unit	65"	29"	32"	Bullnose	500 Lbs.	70 Cu Ft	\$ 4,681	
	LX-219CD-39-BN		65"	29"	39"	Bullnose	500 Lbs.	70 Cu Ft	\$ 4,681	
	LX-217-32-SQ	45 Degree Wedge Corner Unit	20 ⁵ / ₈ "	27"	32"	Square	135 Lbs.	15 Cu Ft	\$ 3,375	Triangular closed wedge corner unit, used to form a 45 degree angle in a circulation desk configuration.
	LX-217-39-SQ		20 ⁵ / ₈ "	27"	39"	Square	135 Lbs.	15 Cu Ft	\$ 3,375	
	LX-217-32-CH	45 Degree Wedge Corner Unit	20 ⁵ / ₈ "	27"	32"	Chamfered	135 Lbs.	15 Cu Ft	\$ 3,463	
	LX-217-39-CH		20 ⁵ / ₈ "	27"	39"	Chamfered	135 Lbs.	15 Cu Ft	\$ 3,463	
	LX-217-32-BN	45 Degree Wedge Corner Unit	20 ⁵ / ₈ "	27"	32"	Bullnose	135 Lbs.	15 Cu Ft	\$ 3,463	
	LX-217-39-BN		20 ⁵ / ₈ "	27"	39"	Bullnose	135 Lbs.	15 Cu Ft	\$ 3,463	
	LX-223-32-SQ	ADA Unit	36"	27"	32"	Square	190 Lbs.	30 Cu Ft	\$ 2,944	Unit used for wheelchair access for either patrons or library staff. Please specify how unit is to be positioned when ordering.
	LX-223-32-CH		36"	27"	32"	Chamfered	190 Lbs.	30 Cu Ft	\$ 3,031	
	LX-223-32-BN		36"	27"	32"	Bullnose	190 Lbs.	30 Cu Ft	\$ 3,031	

	MODEL NUMBER	PRODUCT	W	D	H	EDGE	WEIGHT	VOLUME	LIST PRICE	DESCRIPTION
	LX-212-32-SO	Closed Cupboard with Single Drawer	36"	27"	32"	Square	270 Lbs.	30 Cu Ft	\$ 4,300	Unit complete with one single drawer 5 1/2" high x 20" deep, cupboard doors and one adjustable shelf. Doors function using 95 degree hinges with lock and door pulls. 32" high unit supplied without adjustable shelf
	LX-212-32-CH		36"	27"	32"	Chamfered	270 Lbs.	30 Cu Ft	\$ 4,388	
	LX-212-32-BN		36"	27"	32"	Bullnose	270 Lbs.	30 Cu Ft	\$ 4,388	
	LX-213-39-SO	Hard Drive and Drawer Unit	36"	27"	39"	Square	270 Lbs.	30 Cu Ft	\$ 5,375	Unit complete with two locking box drawers and two file drawers. Box drawers used to store and lock away discs. Cupboard used to store hard-drive. Door uses 95 degree hinges with lock and door pulls. 32" high unit has no box drawers.
	LX-213-39-CH		36"	27"	39"	Chamfered	270 Lbs.	30 Cu Ft	\$ 5,469	
	LX-213-39-BN		36"	27"	39"	Bullnose	270 Lbs.	30 Cu Ft	\$ 5,469	
	LX-214-32-SO	Hard Drive and Open Shelf Unit	36"	27"	32"	Square	260 Lbs.	30 Cu Ft	\$ 4,231	Unit complete with one locking box drawer and open shelves. Cupboard used to store hard-drive. Door uses 95 degree hinges with lock and door pulls. 32" high unit has no box drawers.
	LX-214-39-SO		36"	27"	39"	Square	260 Lbs.	30 Cu Ft	\$ 4,231	
	LX-214-32-CH		36"	27"	32"	Chamfered	260 Lbs.	30 Cu Ft	\$ 4,325	
	LX-214-39-CH		36"	27"	39"	Chamfered	260 Lbs.	30 Cu Ft	\$ 4,325	
	LX-214-32-BN		36"	27"	32"	Bullnose	260 Lbs.	30 Cu Ft	\$ 4,325	
LX-214-39-BN	36"	27"	39"	Bullnose	260 Lbs.	30 Cu Ft	\$ 4,325			
	LX-215-32-SO	Drawer and Cupboard Unit	36"	27"	32"	Square	270 Lbs.	30 Cu Ft	\$ 5,444	Unit complete with one locking box drawer, two file drawers, and a cupboard compartment complete with two adjustable shelves. Door uses 95 degree hinges with lock and door pulls. 32" high unit is supplied without a box drawer and has only one adjustable shelf in cupboard section.
	LX-215-39-SO		36"	27"	39"	Square	270 Lbs.	30 Cu Ft	\$ 5,444	
	LX-215-32-CH		36"	27"	32"	Chamfered	270 Lbs.	30 Cu Ft	\$ 5,538	
	LX-215-39-CH		36"	27"	39"	Chamfered	270 Lbs.	30 Cu Ft	\$ 5,538	
	LX-215-32-BN		36"	27"	32"	Bullnose	270 Lbs.	30 Cu Ft	\$ 5,538	
LX-215-39-BN	36"	27"	39"	Bullnose	270 Lbs.	30 Cu Ft	\$ 5,538			
	LX-216-32-SO	Open Shelf and Drawer Unit	36"	27"	32"	Square	270 Lbs.	30 Cu Ft	\$ 5,219	Unit complete with one locking box drawer and two file drawers, and two adjustable shelves. 32" high unit comes without box drawer and only one adjustable shelf.
	LX-216-39-SO		36"	27"	39"	Square	270 Lbs.	30 Cu Ft	\$ 5,219	
	LX-216-32-CH		36"	27"	32"	Chamfered	270 Lbs.	30 Cu Ft	\$ 5,306	
	LX-216-39-CH		36"	27"	39"	Chamfered	270 Lbs.	30 Cu Ft	\$ 5,306	
	LX-216-32-BN		36"	27"	32"	Bullnose	270 Lbs.	30 Cu Ft	\$ 5,306	
LX-216-39-BN	36"	27"	39"	Bullnose	270 Lbs.	30 Cu Ft	\$ 5,306			



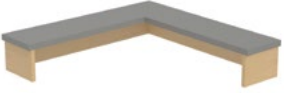



	MODEL NUMBER	PRODUCT	W	D	H	EDGE	WEIGHT	VOLUME	LIST PRICE	DESCRIPTION
	LX-218-32-SO	Curved Desk Unit	65"	29"	32"	Square	320 Lbs.	50 Cu Ft	\$ 5,800	Unit has a 27" wide knee space. Curved desk unit is used to form a 90 degree angle in a circulation desk configuration.
	LX-218-39-SO		65"	29"	39"	Square	320 Lbs.	50 Cu Ft	\$ 5,800	
	LX-218-32-CH	Curved Desk Unit	65"	29"	32"	Chamfered	320 Lbs.	50 Cu Ft	\$ 6,088	
	LX-218-39-CH		65"	29"	39"	Chamfered	320 Lbs.	50 Cu Ft	\$ 6,088	
	LX-218-32-BN	Curved Desk Unit	65"	29"	32"	Bullnose	320 Lbs.	50 Cu Ft	\$ 6,088	
	LX-218-39-BN		65"	29"	39"	Bullnose	320 Lbs.	50 Cu Ft	\$ 6,088	
	LX-218S-32-SO	Curved Desk Unit with Surround	65"	29"	32"	Square	500 Lbs.	70 Cu Ft	\$ 6,413	Unit has 27" wide knee space complete with a 29" high work surface and a surround. Corner desk unit is used to form a 90 degree angle in a circulation desk configuration.
	LX-218S-39-SO		65"	29"	39"	Square	500 Lbs.	70 Cu Ft	\$ 6,413	
	LX-218S-32-CH	Curved Desk Unit with Surround	65"	29"	32"	Chamfered	500 Lbs.	70 Cu Ft	\$ 6,738	
	LX-218S-39-CH		65"	29"	39"	Chamfered	500 Lbs.	70 Cu Ft	\$ 6,738	
	LX-218S-32-BN	Curved Desk Unit with Surround	65"	29"	32"	Bullnose	500 Lbs.	70 Cu Ft	\$ 6,738	
	LX-218S-39-BN		65"	29"	39"	Bullnose	500 Lbs.	70 Cu Ft	\$ 6,738	





	MODEL NUMBER	PRODUCT	W	D	H	EDGE	WEIGHT	VOLUME	LIST PRICE	DESCRIPTION
	LX-225-SQ	Curved Desk Patron Ledge	65"	8 1/2"	7"	Square	70 Lbs.	7 Cu Ft	\$ 2,681	Patron compatible with LX216 curved corner desk unit.
	LX-225-CH		65"	8 1/2"	7"	Chamfered	70 Lbs.	7 Cu Ft	\$ 2,813	
	LX-225-BN		65"	8 1/2"	7"	Bullnose	70 Lbs.	7 Cu Ft	\$ 2,813	
	LX-220-36-SQ	36" Wide Straight Patron Ledge	36"	8 1/2"	7"	Square	30 Lbs.	3 Cu Ft	\$ 1,056	Patron ledge compatible with all standard units. Available 36", 48", 60" or 72" wide.
	LX-220-36-CH		36"	8 1/2"	7"	Chamfered	30 Lbs.	3 Cu Ft	\$ 1,144	
	LX-220-36-BN		36"	8 1/2"	7"	Bullnose	30 Lbs.	3 Cu Ft	\$ 1,144	
	LX-220-48-SQ	48" Wide Straight Patron Ledge	48"	8 1/2"	7"	Square	40 Lbs.	4 Cu Ft	\$ 1,125	
	LX-220-48-CH		48"	8 1/2"	7"	Chamfered	40 Lbs.	4 Cu Ft	\$ 1,238	
	LX-220-48-BN		48"	8 1/2"	7"	Bullnose	40 Lbs.	4 Cu Ft	\$ 1,238	
	LX-220-60-SQ	60" Wide Straight Patron Ledge	60"	8 1/2"	7"	Square	50 Lbs.	5 Cu Ft	\$ 1,194	
	LX-220-60-CH		60"	8 1/2"	7"	Chamfered	50 Lbs.	5 Cu Ft	\$ 1,338	
	LX-220-60-BN		60"	8 1/2"	7"	Bullnose	50 Lbs.	5 Cu Ft	\$ 1,338	
LX-220-72-SQ	72" Wide Straight Patron Ledge	72"	8 1/2"	7"	Square	60 Lbs.	6 Cu Ft	\$ 1,263		
LX-220-72-CH		72"	8 1/2"	7"	Chamfered	60 Lbs.	6 Cu Ft	\$ 1,438		
LX-220-72-BN		72"	8 1/2"	7"	Bullnose	60 Lbs.	6 Cu Ft	\$ 1,438		



	MODEL NUMBER	PRODUCT	W	D	H	EDGE	WEIGHT	VOLUME	LIST PRICE	DESCRIPTION
	LX-220S-SQ	Square Corner Patron Ledge	27"	8 1/2"	7"	Square	40 Lbs.	4 Cu Ft	\$ 1,569	Patron ledge compatible with LX202S square corner units.
	LX-220S-CH		27"	8 1/2"	7"	Chamfered	40 Lbs.	4 Cu Ft	\$ 1,656	
	LX-220S-BN		27"	8 1/2"	7"	Bullnose	40 Lbs.	4 Cu Ft	\$ 1,656	
	LX-220C-SQ	Curved Corner Patron Ledge	27"	8 1/2"	7"	Square	40 Lbs.	4 Cu Ft	\$ 1,881	Patron ledge compatible with LX202C, LX204B, LX204C curved corner units.
	LX-220C-CH		27"	8 1/2"	7"	Chamfered	40 Lbs.	4 Cu Ft	\$ 1,981	
	LX-220C-BN		27"	8 1/2"	7"	Bullnose	40 Lbs.	4 Cu Ft	\$ 1,981	
	LX-220CD-SQ	Corner Desk Patron Ledge	65"	8 1/2"	7"	Square	70 Lbs.	7 Cu Ft	\$ 2,438	Patron ledge compatible with LX219CD Corner desk unit
	LX-220CD-CH		65"	8 1/2"	7"	Chamfered	70 Lbs.	7 Cu Ft	\$ 2,619	
	LX-220CD-BN		65"	8 1/2"	7"	Bullnose	70 Lbs.	7 Cu Ft	\$ 2,619	





MODEL NUMBER	PRODUCT	W	D	H	EDGE	WEIGHT	VOLUME	LIST PRICE	DESCRIPTION
LX-222-32-SO LX-222-39-SO	Finish End Panels	32"	27 ¹ / ₄ "		Square	50 Lbs.	30 Cu Ft	\$ 769	27 ¹ / ₄ " deep x 1 ¹ / ₄ " thick
		32"	27 ¹ / ₄ "		Square	50 Lbs.	30 Cu Ft	\$ 769	
LX-222-32-CH LX-222-39-CH		32"	27 ¹ / ₄ "		Chamfered	50 Lbs.	30 Cu Ft	\$ 769	
		32"	27 ¹ / ₄ "		Chamfered	50 Lbs.	30 Cu Ft	\$ 769	
LX-222-32-BN LX-222-39-BN		32"	27 ¹ / ₄ "		Bullnose	50 Lbs.	30 Cu Ft	\$ 769	
		32"	27 ¹ / ₄ "		Bullnose	50 Lbs.	30 Cu Ft	\$ 769	











	MODEL NUMBER	PRODUCT	W	D	H	EDGE	WEIGHT	VOLUME	LIST PRICE	DESCRIPTION
	GS-200-32-SQ	Open Shelf Unit	34"	30"	32"	Square	235 Lbs.	30 Cu Ft	\$ 2,288	Unit complete with fixed bottom and two adjustable shelves. 32" high unit complete with one adjustable shelf.
	GS-200-39-SQ		34"	30"	39"	Square	235 Lbs.	30 Cu Ft	\$ 2,288	
	GS-200-32-BN	34"	30"	32"	Bullnose	235 Lbs.	30 Cu Ft	\$ 2,375		
	GS-200-39-BN	34"	30"	39"	Bullnose	235 Lbs.	30 Cu Ft	\$ 2,375		
	GS-201-32-SQ	Cupboard Unit	34"	30"	32"	Square	260 Lbs.	30 Cu Ft	\$ 3,031	Unit comes complete with two adjustable shelves. Doors function using 95 degree hinges with lock and door pulls. 32" high unit receives one adjustable shelf.
	GS-201-39-SQ		34"	30"	39"	Square	260 Lbs.	30 Cu Ft	\$ 3,031	
	GS-201-32-BN	34"	30"	32"	Bullnose	260 Lbs.	30 Cu Ft	\$ 3,119		
	GS-201-39-BN	34"	30"	39"	Bullnose	260 Lbs.	30 Cu Ft	\$ 3,119		
	GS-202T-32-SQ	Closed Triangular Corner Unit	30"	30"	32"	Square	160 Lbs.	25 Cu Ft	\$ 2,900	Triangular closed face corner unit. Unit is used to form a 90 degree angle in a circulation desk configuration.
	GS-202T-39-SQ		30"	30"	39"	Square	160 Lbs.	25 Cu Ft	\$ 2,900	
	GS-202T-32-BN	30"	30"	32"	Bullnose	160 Lbs.	25 Cu Ft	\$ 2,994		
	GS-202T-39-BN	30"	30"	39"	Bullnose	160 Lbs.	25 Cu Ft	\$ 2,994		
	GS-202C-32-SQ	Closed Curved Corner Unit	30"	30"	32"	Square	160 Lbs.	25 Cu Ft	\$ 3,931	Curved closed corner unit used to form a 90 degree angle in a circulation desk configuration.
	GS-202C-39-SQ		30"	30"	39"	Square	160 Lbs.	25 Cu Ft	\$ 3,931	
	GS-202C-32-BN	30"	30"	32"	Bullnose	160 Lbs.	25 Cu Ft	\$ 4,025		
	GS-202C-39-BN	30"	30"	39"	Bullnose	160 Lbs.	25 Cu Ft	\$ 4,025		
	GS-202S-32-SQ	Closed Square Corner Unit	30"	30"	32"	Square	160 Lbs.	25 Cu Ft	\$ 2,631	Square corner unit used to form a 90 degree angle in a circulation desk configuration. Unit complete with closed flush panel design.
	GS-202S-39-SQ		30"	30"	39"	Square	160 Lbs.	25 Cu Ft	\$ 2,631	
	GS-202S-32-BN	30"	30"	32"	Bullnose	160 Lbs.	25 Cu Ft	\$ 2,725		
	GS-202S-39-BN	30"	30"	39"	Bullnose	160 Lbs.	25 Cu Ft	\$ 2,725		
	GS-203-32-SQ	Knee Space Unit with Cash and Pencil Drawer	34"	30"	32"	Square	210 Lbs.	30 Cu Ft	\$ 2,825	Unit complete with one pencil drawer, one locking cash drawer and a fixed shelf. Cash drawer will be 5 1/2" high x 12" wide.
	GS-203-39-SQ		34"	30"	39"	Square	210 Lbs.	30 Cu Ft	\$ 2,825	
	GS-203-32-BN	34"	30"	32"	Bullnose	210 Lbs.	30 Cu Ft	\$ 2,913		
	GS-203-39-BN	34"	30"	39"	Bullnose	210 Lbs.	30 Cu Ft	\$ 2,913		





	MODEL NUMBER	PRODUCT	W	D	H	EDGE	WEIGHT	VOLUME	LIST PRICE	DESCRIPTION
	GS-204-32-SQ	Open Triangle Corner Unit	30"	30"	32"	Square	150 Lbs.	25 Cu Ft	\$ 2,456	Triangular open face corner unit complete with two adjustable shelves. Unit is used to form a 90 degree angle in a circulation desk configuration. 32" high unit complete with one adjustable shelf.
	GS-204-39-SQ		30"	30"	39"	Square	150 Lbs.	25 Cu Ft	\$ 2,456	
	GS-204-32-BN	30"	30"	32"	Bullnose	150 Lbs.	25 Cu Ft	\$ 2,556		
	GS-204-39-BN	30"	30"	39"	Bullnose	150 Lbs.	25 Cu Ft	\$ 2,556		
	GS-206-32-SQ	Single Drawer Charge Unit	34"	30"	32"	Square	220 Lbs.	30 Cu Ft	\$ 2,725	Unit complete with one single drawer. Drawer will be 5 1/2" high x 20" deep.
	GS-206-39-SQ		34"	30"	39"	Square	220 Lbs.	30 Cu Ft	\$ 2,725	
	GS-206-32-BN	34"	30"	32"	Bullnose	220 Lbs.	30 Cu Ft	\$ 2,813		
	GS-206-39-BN	34"	30"	39"	Bullnose	220 Lbs.	30 Cu Ft	\$ 2,813		
	GS-207-32-SQ	Single Drawer Open Shelf Unit	34"	30"	32"	Square	250 Lbs.	30 Cu Ft	\$ 2,900	Unit complete with one single drawer and two adjustable shelves. Drawer will be 5 1/2" high x 20" deep. 32" high unit complete with one adjustable shelf.
	GS-207-39-SQ		34"	30"	39"	Square	250 Lbs.	30 Cu Ft	\$ 2,900	
	GS-207-32-BN	34"	30"	32"	Bullnose	250 Lbs.	30 Cu Ft	\$ 2,994		
	GS-207-39-BN	34"	30"	39"	Bullnose	250 Lbs.	30 Cu Ft	\$ 2,994		
	GS-208-32-SQ	Book Return Unit	34"	30"	32"	Square	185 Lbs.	30 Cu Ft	\$ 2,194	Unit will fit a T-100 depressible book truck. (Sold separately) Front panel complete with a 3" high x 14" long slanted book shute. Front edges of shute banded with 1/4" solid hardwood.
	GS-208-39-SQ		34"	30"	39"	Square	185 Lbs.	30 Cu Ft	\$ 2,194	
	GS-208-32-BN	34"	30"	32"	Bullnose	185 Lbs.	30 Cu Ft	\$ 2,281		
	GS-208-39-BN	34"	30"	39"	Bullnose	185 Lbs.	30 Cu Ft	\$ 2,281		

MODEL NUMBER	PRODUCT	W	D	H	EDGE	WEIGHT	VOLUME	LIST PRICE	DESCRIPTION	
	GS-209-3632-SQ	34" Wide Desk Unit	34"	30"	32"	Square	200 Lbs.	30 Cu Ft	\$ 2,600	Unit is 34", 46", 58" or 70" wide x 30" deep complete with a 29" high work surface. Alternate work surface heights may be specified at no additional charge. Patron ledge is at 39" or 32" high. A V-shaped metal keel will be fastened to the underside of the work surface for added support on the 58" and 70" wide units.
	GS-209-3639-SQ	with Patron	34"	30"	39"	Square	200 Lbs.	30 Cu Ft	\$ 2,600	
	GS-209-3632-BN		34"	30"	32"	Bullnose	200 Lbs.	30 Cu Ft	\$ 2,681	
	GS-209-3639-BN		34"	30"	39"	Bullnose	200 Lbs.	30 Cu Ft	\$ 2,681	
	GS-209-4832-SQ	46" Wide Desk Unit	46"	30"	32"	Square	250 Lbs.	40 Cu Ft	\$ 2,750	
	GS-209-4839-SQ	with Patron	46"	30"	39"	Square	250 Lbs.	40 Cu Ft	\$ 2,750	
	GS-209-4832-BN		46"	30"	32"	Bullnose	250 Lbs.	40 Cu Ft	\$ 2,863	
	GS-209-4839-BN		46"	30"	39"	Bullnose	250 Lbs.	40 Cu Ft	\$ 2,863	
	GS-209-6032-SQ	58" Wide Desk Unit	58"	30"	32"	Square	320 Lbs.	50 Cu Ft	\$ 3,006	
	GS-209-6039-SQ	with Patron	58"	30"	39"	Square	320 Lbs.	50 Cu Ft	\$ 3,006	
	GS-209-6032-BN		58"	30"	32"	Bullnose	320 Lbs.	50 Cu Ft	\$ 3,144	
	GS-209-6039-BN		58"	30"	39"	Bullnose	320 Lbs.	50 Cu Ft	\$ 3,144	
	GS-209-7232-SQ	70" Wide Desk Unit	70"	30"	32"	Square	390 Lbs.	60 Cu Ft	\$ 3,156	
	GS-209-7239-SQ	with Patron	70"	30"	39"	Square	390 Lbs.	60 Cu Ft	\$ 3,156	
	GS-209-7232-BN		70"	30"	32"	Bullnose	390 Lbs.	60 Cu Ft	\$ 3,319	
	GS-209-7239-BN		70"	30"	39"	Bullnose	390 Lbs.	60 Cu Ft	\$ 3,319	
	GS-209CD-32-SQ	Corner Desk Unit	68 ³ / ₄ "	32"	32"	Square	500 Lbs.	70 Cu Ft	\$ 4,675	Unit has a 27" wide knee space complete with a 29" high work surface and a surround. Unit also forms a 90 degree angle in a circulation desk configuration.
	GS-209CD-39-SQ	with Surround	68 ³ / ₄ "	32"	39"	Square	500 Lbs.	70 Cu Ft	\$ 4,675	
	GS-209CD-32-BN		68 ³ / ₄ "	32"	32"	Bullnose	500 Lbs.	70 Cu Ft	\$ 5,206	
	GS-209CD-39-BN		68 ³ / ₄ "	32"	39"	Bullnose	500 Lbs.	70 Cu Ft	\$ 5,206	



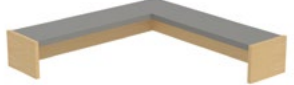

	MODEL NUMBER	PRODUCT	W	D	H	EDGE	WEIGHT	VOLUME	LIST PRICE	DESCRIPTION	
	GS-219-3632-SQ	34" Wide Desk Unit	34"	30"	32"	Square	200 Lbs.	30 Cu Ft	\$ 2,113	Unit is 34", 46", 58" or 70" wide x 30" deep no patron ledge. A V-shaped metal keel will be fastened to the underside of the work surface for added support on the 58" and 70" wide units.	
	GS-219-3639-SQ		34"	30"	39"	Square	200 Lbs.	30 Cu Ft	\$ 2,113		
	GS-219-3632-BN	34"	34"	30"	32"	Bullnose	200 Lbs.	30 Cu Ft	\$ 2,200		
	GS-219-3639-BN		34"	30"	39"	Bullnose	200 Lbs.	30 Cu Ft	\$ 2,200		
		GS-219-4832-SQ	46" Wide Desk Unit	46"	30"	32"	Square	250 Lbs.	40 Cu Ft		\$ 2,231
		GS-219-4839-SQ		46"	30"	39"	Square	250 Lbs.	40 Cu Ft		\$ 2,231
GS-219-4832-BN		46"	46"	30"	32"	Bullnose	250 Lbs.	40 Cu Ft	\$ 2,288		
GS-219-4839-BN			46"	30"	39"	Bullnose	250 Lbs.	40 Cu Ft	\$ 2,288		
		GS-219-6032-SQ	58" Wide Desk Unit	58"	30"	32"	Square	320 Lbs.	50 Cu Ft	\$ 2,456	
		GS-219-6039-SQ		58"	30"	39"	Square	320 Lbs.	50 Cu Ft	\$ 2,456	
	GS-219-6032-BN	58"	58"	30"	32"	Bullnose	320 Lbs.	50 Cu Ft	\$ 2,600		
	GS-219-6039-BN		58"	30"	39"	Bullnose	320 Lbs.	50 Cu Ft	\$ 2,600		
		GS-219-7232-SQ	70" Wide Desk Unit	70"	30"	32"	Square	390 Lbs.	60 Cu Ft	\$ 2,575	
		GS-219-7239-SQ		70"	30"	39"	Square	390 Lbs.	60 Cu Ft	\$ 2,575	
GS-219-7232-BN		70"	70"	30"	32"	Bullnose	390 Lbs.	60 Cu Ft	\$ 2,750		
GS-219-7239-BN			70"	30"	39"	Bullnose	390 Lbs.	60 Cu Ft	\$ 2,750		
		GS-219CD-32-SQ	Corner Desk Unit	68 ³ / ₄ "	32"	32"	Square	500 Lbs.	70 Cu Ft	\$ 3,731	Unit has a 27" wide knee space. Unit also forms a 90 degree angle in a circulation desk configuration.
		GS-219CD-39-SQ		68 ³ / ₄ "	32"	39"	Square	500 Lbs.	70 Cu Ft	\$ 3,731	
	GS-219CD-32-BN	68 ³ / ₄ "	68 ³ / ₄ "	32"	32"	Bullnose	500 Lbs.	70 Cu Ft	\$ 4,013		
	GS-219CD-39-BN		68 ³ / ₄ "	32"	39"	Bullnose	500 Lbs.	70 Cu Ft	\$ 4,013		





	MODEL NUMBER	PRODUCT	W	D	H	EDGE	WEIGHT	VOLUME	LIST PRICE	DESCRIPTION
	GS-212-39-SQ	Closed Cupboard with Single Drawer	34"	30"	39"	Square	270 Lbs.	30 Cu Ft	\$ 3,494	Unit complete with one single drawer 5 1/2" high x 20" deep, cupboard doors and one adjustable shelf. Doors function using 95 degree hinges with lock and door pulls. 32" high unit has no adjustable shelf.
	GS-212-39-BN		34"	30"	39"	Bullnose	270 Lbs.	30 Cu Ft	\$ 3,581	
	GS-213-39-SQ	Hard Drive and Drawer Unit	34"	30"	39"	Square	270 Lbs.	30 Cu Ft	\$ 5,413	Unit complete with two locking box drawers and two file drawers. Box drawers used to store and lock away discs. Cupboard used to store hard-drive. Door uses 95 degree hinges with lock and door pulls. 32" high unit has no box drawers.
	GS-213-39-BN		34"	30"	39"	Bullnose	270 Lbs.	30 Cu Ft	\$ 5,500	
	GS-214-32-SQ	Hard Drive and Open Shelf Unit	34"	30"	32"	Square	260 Lbs.	30 Cu Ft	\$ 4,269	Unit complete with one box drawer above hard-drive compartment used to store and lock away discs, cupboard, used to store hard-drive, and two adjustable shelves. Door uses 95 degree hinges with lock and door pulls. 32" high unit has no box drawer and only one adjustable shelf.
	GS-214-39-SQ		34"	30"	39"	Square	260 Lbs.	30 Cu Ft	\$ 4,269	
	GS-214-32-BN		34"	30"	32"	Bullnose	260 Lbs.	30 Cu Ft	\$ 4,356	
	GS-214-39-BN		34"	30"	39"	Bullnose	260 Lbs.	30 Cu Ft	\$ 4,356	
	GS-215-32-SQ	Drawer and Cupboard Unit	34"	30"	32"	Square	270 Lbs.	30 Cu Ft	\$ 5,431	Unit complete with one locking box drawer, two file drawers, and a cupboard compartment complete with two adjustable shelves. Door uses 95 degree hinges with, lock and door pulls. 32" high unit has no box drawer and only one adjustable shelf in cupboard section.
	GS-215-39-SQ		34"	30"	39"	Square	270 Lbs.	30 Cu Ft	\$ 5,431	
	GS-215-32-BN		34"	30"	32"	Bullnose	270 Lbs.	30 Cu Ft	\$ 5,519	
	GS-215-39-BN		34"	30"	39"	Bullnose	270 Lbs.	30 Cu Ft	\$ 5,519	
	GS-216-32-SQ	Open Shelf and Drawer Unit	34"	30"	32"	Square	270 Lbs.	30 Cu Ft	\$ 5,250	Unit complete with one locking box drawer and two file drawers, and two adjustable shelves. 32" high unit has no box drawer and only one adjustable shelf.
	GS-216-39-SQ		34"	30"	39"	Square	270 Lbs.	30 Cu Ft	\$ 5,250	
	GS-216-32-BN		34"	30"	32"	Bullnose	270 Lbs.	30 Cu Ft	\$ 5,338	
	GS-216-39-BN		34"	30"	39"	Bullnose	270 Lbs.	30 Cu Ft	\$ 5,338	





	MODEL NUMBER	PRODUCT	W	D	H	EDGE	WEIGHT	VOLUME	LIST PRICE	DESCRIPTION
	GS-218-32-SQ	Curved Desk Unit	68"	32"	32"	Square	320 Lbs.	50 Cu Ft	\$ 5,244	Unit has a 27" wide knee space. Unit used to form a 90 degree angle in a circulation desk configuration.
	GS-218-39-SQ		68"	32"	39"	Square	320 Lbs.	50 Cu Ft	\$ 5,244	
	GS-218-32-BN	68"	32"	32"	Bullnose	320 Lbs.	50 Cu Ft	\$ 5,506		
	GS-218-39-BN	68"	32"	39"	Bullnose	320 Lbs.	50 Cu Ft	\$ 5,506		
	GS-218S-32-SQ	Curved Corner Desk with Surround	68"	32"	32"	Square	500 Lbs.	70 Cu Ft	\$ 6,238	Unit has 27" wide knee space complete with a 29" high work surface and a surround. Corner desk unit is used to form a 90 degree angle in a circulation desk configuration.
	GS-218S-39-SQ		68"	32"	39"	Square	500 Lbs.	70 Cu Ft	\$ 6,238	
	GS-218S-32-BN	68"	32"	32"	Bullnose	500 Lbs.	70 Cu Ft	\$ 6,550		
	GS-218S-39-BN	68"	32"	39"	Bullnose	500 Lbs.	70 Cu Ft	\$ 6,550		
	GS-223-32-SQ	ADA Unit	68"	32"	32"	Square	200 Lbs.	30 Cu Ft	\$ 2,175	Unit used for wheelchair access for either patrons or library staff. Please specify how unit is to be positioned when ordering.
	GS-223-32-BN		68"	32"	32"	Bullnose	500 Lbs.	70 Cu Ft	\$ 2,269	

	MODEL NUMBER	PRODUCT	W	D	H	EDGE	WEIGHT	VOLUME	LIST PRICE	DESCRIPTION
	GS-225-SQ	Curved Corner Desk Patron Ledge	68"	8 1/2"	7"	Square	70 Lbs.	7 Cu Ft	\$ 3,000	Patron ledge is compatible with GS218 curved corner desk unit
	GS-225-BN		68"	8 1/2"	7"	Bullnose	70 Lbs.	7 Cu Ft	\$ 3,150	
	GS-220-36-SQ	36" Wide Straight Patron Ledge	36"	8 1/2"	7"	Square	30 Lbs.	3 Cu Ft	\$ 1,056	Patron ledge compatible with all standard units. Available 36", 48", 60" or 72" wide.
	GS-220-36-BN		36"	8 1/2"	7"	Bullnose	30 Lbs.	3 Cu Ft	\$ 1,144	
	GS-220-48-SQ	48" Wide Straight Patron Ledge	48"	8 1/2"	7"	Square	40 Lbs.	4 Cu Ft	\$ 1,125	
	GS-220-48-BN		48"	8 1/2"	7"	Bullnose	40 Lbs.	4 Cu Ft	\$ 1,238	
	GS-220-60-SQ	60" Wide Straight Patron Ledge	60"	8 1/2"	7"	Square	50 Lbs.	5 Cu Ft	\$ 1,188	
	GS-220-60-BN		60"	8 1/2"	7"	Bullnose	50 Lbs.	5 Cu Ft	\$ 1,338	
GS-220-72-SQ	72" Wide Straight Patron Ledge	72"	8 1/2"	7"	Square	60 Lbs.	6 Cu Ft	\$ 1,256		
GS-220-72-BN		72"	8 1/2"	7"	Bullnose	60 Lbs.	6 Cu Ft	\$ 1,431		
	GS-220S-SQ	Square Corner Patron Ledge	29"	8 1/2"	7"	Square	40 Lbs.	4 Cu Ft	\$ 1,594	Patron ledge compatible with GS202S square corner units.
	GS-220S-BN		29"	8 1/2"	7"	Bullnose	40 Lbs.	4 Cu Ft	\$ 1,694	
	GS-220C-SQ	Curved Corner Patron Ledge	29"	8 1/2"	7"	Square	40 Lbs.	4 Cu Ft	\$ 1,813	Patron ledge compatible with SC202C curved corner unit.
	GS-220C-BN		29"	8 1/2"	7"	Bullnose	40 Lbs.	4 Cu Ft	\$ 1,906	
	GS-220CD-SQ	Corner Desk Patron Ledge	68 3/4"	8 1/2"	7"	Square	70 Lbs.	7 Cu Ft	\$ 2,506	Patron ledge compatible with GS219CD Corner desk unit.
	GS-220CD-BN		68 3/4"	8 1/2"	7"	Bullnose	70 Lbs.	7 Cu Ft	\$ 2,775	

MODEL NUMBER	PRODUCT	W	D	H	EDGE	WEIGHT	VOLUME	LIST PRICE	DESCRIPTION
 GS-EP-32 GS-EP-39	End Panels	32"	30 ¹ / ₂ "			50 Lbs.	30 Cu Ft	\$ 775	1 ¹ / ₄ " thick x 30 ¹ / ₂ " deep. Circulation desk end panel.
		39"	30 ¹ / ₂ "			50 Lbs.	30 Cu Ft	\$ 775	
GS-MP-32 GS-MP-39	Intermediate Panels	32"	30 ¹ / ₂ "			50 Lbs.	30 Cu Ft	\$ 875	
		39"	30 ¹ / ₂ "			50 Lbs.	30 Cu Ft	\$ 875	

	MODEL NUMBER	PRODUCT	W	D	H	WEIGHT	VOLUME	LIST PRICE	DESCRIPTION
	CD-M20	Mobile Pedestal: Open Shelf	20 1/2"	20 1/2"	26 1/2"	65 Lbs.	8 Cu.Ft	\$ 1,844	Unit complete with plastic laminate top, 4 dual swivel casters and one adjustable shelf.
	CD-M30	Mobile Pedestal: Cupboard Unit	20 1/2"	20 1/2"	26 1/2"	70 Lbs.	8 Cu.Ft	\$ 2,281	Unit complete with plastic laminate top, 4 dual swivel casters and one adjustable shelf. Cupboard doors function on chrome piano hinges complete with lock.
	CD-M40	Mobile Pedestal: Drawer Unit	20 1/2"	20 1/2"	26 1/2"	75 Lbs.	8 Cu.Ft	\$ 2,494	Unit complete with plastic laminate top, 4 dual swivel casters, two box drawers, one file drawer and lock.
	CD-M50	Mobile File Unit	20 1/2"	20 1/2"	26 1/2"	75 Lbs.	8 Cu.Ft	\$ 2,544	Unit complete with plastic laminate top, 4 dual swivel caster, two files drawers and lock.

	MODEL NUMBER	PRODUCT	W	D	H	WEIGHT	VOLUME	LIST PRICE	DESCRIPTION
	CD-250-BF	Hanging Pedestal: 1 Box, 1 File	18"	21 ⁵ / ₈ "	20 ¹ / ₂ "	50 Lbs.	4 Cu.Ft	\$ 1,575	Hanging pedestal complete with one box drawer and one file drawer and lock. Constructed of 3/4" thick veneer particleboard core.
	CD-250-B3	Hanging Pedestal: 3 Box	18"	21 ⁵ / ₈ "	20 ¹ / ₂ "	50 Lbs.	4 Cu.Ft	\$ 1,763	Hanging pedestal complete with 3 box drawers and lock. Constructed of 3/4" thick veneer particleboard core.
	CD-250-F2	Hanging Pedestal: 2 File	18"	21 ⁵ / ₈ "	20 ¹ / ₂ "	50 Lbs.	4 Cu.Ft	\$ 1,856	Hanging pedestal complete with 2 file drawers and lock. Constructed of 3/4" thick veneer particle core.
	CD-250-2BF	Hanging Pedestal: 2 Box, 1 File	18"	21 ⁵ / ₈ "	20 ¹ / ₂ "	50 Lbs.	4 Cu.Ft	\$ 1,900	Hanging pedestal complete with 2 box drawers and 1 file drawer and lock. Constructed of 3/4" thick veneer particle core.
	CD-250-CPU	Hanging Pedestal: CPU Storage	11 ³ / ₄ "	21 ¹ / ₂ "	20"	70 Lbs.	6 Cu.Ft	\$ 1,375	CPU pedestal with locking compartment to accommodate hard drive. Inside compartment measures. 10-1/4" wide x 21-3/4" high x 22" deep. Ventilation holes 2" x 12" are cut out on top and bottom of each side of pedestal. Cabinet constructed from 3/4" thick 3-ply veneer particleboard, assembled together by means of tongue and groove assembly. Front door operates with the use of chrome piano hinge complete with lock.

	MODEL NUMBER	PRODUCT	W	D	H	WEIGHT	VOLUME	LIST PRICE	DESCRIPTION
	CD-250-P	Pencil Drawer	18"	18 ³ / ₄ "	3 ³ / ₈ "	10 Lbs.	0.5 Cu.Ft	\$ 631	Hanging pencil drawer constructed from 1/2" thick mahogany veneer plywood, bottom constructed of 1/4". Drawer front constructed from 3/4" thick x 3" high 3-ply particleboard core with grade "A" select veneer faces. Drawer assembled together by means of tongue and groove assembly. Drawers run on blum slides.
	CD-250-PK	Pull-out Keyboard	23 ¹ / ₂ "	17"	3 ³ / ₄ "	15 Lbs.	0.5 Cu.Ft	\$ 638	Keyboard tray 9-1/4" deep x 22" wide inside dimension. Keyboard constructed from black ABS plastic. Tray slides out on ball bearing drawer slides and locks into place. Unit comes complete with mounting brackets.
	CD-250-AK	Articulating Keyboard	23 ³ / ₄ "	11"	3/4"	15 Lbs.	0.5 Cu.Ft	\$ 638	Unit complete with a 9-1/4" deep x 22" wide inside dimension keyboard tray. Keyboard constructed from ABS plastic, sits and functions on an adjustable retractable metal neck. Tray swivels a full 360 degrees and tilts up 15 degrees. Available in black only.
	CD-200-32	Swing Gate 32"	34"	1"	22"	10 Lbs.	1 Cu.Ft	\$ 1,594	Gate constructed from 1" thick 3-ply veneer core, grade "A" veneer both faces. All edges banded with 1/4" solid external hardwood. Gate mounting support constructed from 3/4" thick x 3" wide solid hardwood. Gate swings using double action spring-loaded hinges.
	CD-200-39	Swing Gate 39"	34"	1"	29"	10 Lbs.	1 Cu.Ft	\$ 1,594	

Palmieri Furniture Limited ("Palmieri") warrants that its products and collections are free from defects in materials and workmanship for the life of the product, except as set forth below. Palmieri Limited Lifetime Warranty is valid from the date of delivery.

Exceptions to the Limited Lifetime Warranty: Seating: two (2) years

Goods sold hereunder are covered by a Limited Lifetime Warranty, free against defects in material and workmanship provided the goods and services are subjected to normal use and service. The applicable warranty period commences from shipping date to Purchaser of any item of the goods, whichever occurs first, or any other warranty period otherwise stipulated in writing by Palmieri under this sale. For components not supplied by Palmieri, the original manufacturer's warranty shall apply to the extent assignable by Palmieri. The obligation under this warranty is limited to the repair or replacement, at Palmieri's option, of defective parts F.O.B. point of shipment provided that prompt notice of any defect is given by Purchaser to Palmieri in writing within the applicable warranty period and that upon the Purchaser's return of the defective parts to Palmieri or, if designated by Palmieri, to the location where the works are made, properly packed and with transportation charges prepaid by Purchaser, an inspection thereof shall reveal to Palmieri's satisfaction that Purchaser's claim is valid under the terms of this warranty. Purchaser shall assume all responsibility and expense for dismantling, removal, re-installation and freight in connection with the foregoing. The same obligations and conditions extend to replacement parts furnished by Palmieri hereunder.

Palmieri does not assume liability for installation, labour or consequential damages. Palmieri makes no warranty other than the one set forth herein. All other warranties, legal, expressed or implied, including but not limited to any expressed or implied warranty of merchantability, of fitness for the intended use thereof or against infringement are hereby expressly excluded. The applicable warranty ceases to be effective if the goods are altered or repaired other than by persons authorized or approved by Palmieri to perform such work. Repairs or replacement deliveries do not interrupt or prolong the term of the warranty. The warranty ceases to be effective if Purchaser fails to handle and use the goods sold hereunder in a safe and reasonable manner and in accordance with any written instructions from the manufacturers.

Warranty Does Not Apply To Product Failure Or Loss Resulting From:

Abuse, misuse or accident, alteration or modification of product by customer or third party, normal wear and tear, improper installation, handling or incorrect use. The substitution of part components or hardware not approved or authorized by Palmieri, acts of God, unauthorized repairs, improper storage, and environmental conditions such as irregular temperature control either inside or outside the environment.

Warranty Provides Exclusive Remedies:

If a product fails under ordinary use as a result of a defect in material or workmanship, Palmieri will: (A) repair, or (B) replace the furniture. The replacement or repair of the Furniture or Seating will be at the discretion of Palmieri. If the defect or workmanship cannot be remedied on site, repairs can be made at the factory. (C) If the product repair or replacement is not commercially practicable or cannot be remade in a timely manner Palmieri will refund the purchase price of the affected product. A product "**Defect**" means: an inadequacy in the materials or workmanship of the product that (A) existed at the time when you received the product from Palmieri or Palmieri authorized Reseller and (B) causes a failure of the product to perform under ordinary use in accordance with the materials and documentation accompanying the product. "**Ordinary Use**" means: use of the product (A) in accordance with all applicable local, state or federal laws, codes and regulations and (B) in accordance with manufacturer recommendations and or instructions in the materials and documentation accompanying the product or through shop drawings. A "**Palmieri Authorized Reseller**" means: any dealer that is legally permitted to conduct business in the jurisdiction where the product is sold and is duly authorized by Palmieri to sell the product.

Warranty work must be approved by authorized personnel of Palmieri Furniture Limited in Richmond Hill, Ontario, Canada.

A copy of the original purchase order must accompany all claims.

Warranty Does Not Cover:

Matching of colours, stains, textures, grains and any other variations in materials. Select and Custom Surfaces and materials are only warranted for their application on the specified product and are not covered by our warranty, except as warranted by the original supplier, for quality, colorfastness, shade variations or abrasion and textiles purchased for Palmieri product.

This limited warranty is the sole remedy for product defect and no other express or implied warranty is provided. Warranty is not transferable and valid only for the original purchaser acquiring a product from Palmieri or a Palmieri authorized reseller for the purchaser's own use and not for resale, remarketing or distribution. Limited Lifetime Warranty (25 years)

GENERAL

The following Terms and Conditions of Quote and Sale shall apply to any sale of goods and services by Palmieri Furniture Limited (hereinafter called "Palmieri"). Purchaser shall be deemed to have full knowledge of the terms and conditions herein and such terms and conditions shall be binding if either the goods and services referred to herein are delivered to and accepted by Purchaser, or if Purchaser does not within five (5) days from the date hereof deliver to Palmieri written objection to said terms and conditions or any part thereof.

In the event of any conflict or inconsistency between the terms and conditions of sale herein and the terms and conditions contained in Purchaser's order or in any other form issued by Purchaser, whether or not any such form has been acknowledged or accepted by Palmieri, Palmieri's terms and conditions herein shall prevail. No waiver, alteration or modification of these terms and conditions shall be binding upon Palmieri unless made in writing and signed by a duly authorized representative of Palmieri.

1. QUOTATIONS / PRODUCT QUOTED

Unless otherwise stated, **Palmieri's quotations shall be null and void unless accepted by Purchaser within thirty (30) days from the date of quotation.** Quotes may be subject to change before order placement, due to increased material costs and or other factors that could impact the final cost of production and our final understanding of the product required. If the items quoted do not reflect the intended product requirements of the customer, Palmieri will not be held responsible for increased costs for those product changes. We reserve the right to edit or re-quote any portion of a previously submitted quotation subject to our final understanding of the product required by the client.

2. PALMIERI DRAWINGS

Palmieri provides drawings for Custom & Standard product we produce to our clients upon request. We consider these drawings to be Private and Confidential and are provided for the sole purpose and use of our clients to understand the product we are providing. The use of these confidential materials is limited to the transaction between the parties and at no point are these confidential materials to be sent to any of our competitors or parties quoting for the same purpose.

A minimum \$85.00 NET Engineering Administrative Fee will apply for Custom Product Drawings

(Note: The first set of Custom product drawings will be free of charge)

A minimum \$120.00 NET Engineering Administrative Fee will apply for all Standard Product Drawings

3. TERMS OF PAYMENT

For authorized customers; Orders at a \$75,000.00 threshold will require a mandatory 25% deposit. Orders over and above \$100,000.00 requires a mandatory (25%) deposit at time of order, a mandatory (25%) deposit prior to product shipment and the balance to be paid within thirty (30) days of date of shipment. Payment not be made to Palmieri when due, Palmieri reserves the right to charge Purchaser with interest on such overdue payments. Interest of 2% per month (24% per annum) is charged on all overdue accounts, unless otherwise specified. The charging of such interest shall not be construed as obligating Palmieri to grant any extension of time in the terms of payment. All goods remain the property of Palmieri, until balance is paid in full to Palmieri.

4. TITLE

Title to the goods or any part thereof shall not pass from Palmieri to Purchaser until all payments due hereunder have been duly made, except as otherwise expressly stipulated herein. The goods shall be and remain personal or moveable property, notwithstanding their mode of attachment to realty or other property. If default is made in any of the payments herein, Purchaser agrees that Palmieri may retain all payments which have been made on account of the purchase price as liquidated damages, and Palmieri shall be free to enter the premises where the goods may be located and remove them as Palmieri's property, without prejudice to Palmieri's right to recover any further expenses or damages Palmieri may suffer by reason of such nonpayment.

5. TAXES

Prices do not include Goods & Services Tax, Provincial or Municipal sales, use, value-added or similar tax. All applicable taxes are extra. Our Harmonized Sales Tax (HST) registration number is R104055066.

6. THE AGREEMENT

An acceptance and official confirmation of Purchasers' order by signing Palmieri's Order Confirmation the Purchaser therefore is accepting terms and conditions as expressed herein Palmieri's Terms and Conditions of Quote and Sale by Palmieri and shall constitute the complete agreement, subject to the terms and conditions of sale herein set forth, and shall supersede all previous quotations, orders or agreements.

7. LEAD TIME / DELIVERY / DELAYS

Lead time is determined only when final material/finish selection and drawing approvals are received by Palmieri from the client. The accuracy of Palmieri's lead times, is created to the best of our ability with the information provided to us. Confirmed lead time is conveyed to the client by means of Order Confirmation. They do not preclude the client from checking the accuracy of your requirement and our Order Confirmation. Any noted discrepancies are to be reported immediately to Palmieri Customer Service Department for correction and re-issue of revised Order Confirmation. By signing and dating the Order Confirmation the client accepts the terms and conditions of quote and sale.

Lead time on our Order Confirmation do not account for delays that could potentially occur for special materials specified by the client that are outside of our standard finishes and materials program that are out of our control

and will affect the lead time on the order. Palmieri will notify the client immediately when these delays occur and adjust the lead time accordingly.

Delivery schedules are approximate and are based on prevailing market conditions applicable respectively at the time of Palmieri's quotation and Palmieri's acceptance of clients' order, if certain portions of an order are completed by the quoted lead time while other portions have experienced delays outside of our control. The client may choose to part ship the order at their discretion and expense. Otherwise the entire order will ship with the delayed portion at a later date. Palmieri may extend delivery schedules or may, at its option, cancel Purchaser's order in full or in part without liability other than to return any deposit or prepayment which is unearned by reason of the cancellation.

8. CHANGES AND CANCELLATION

Orders accepted by Palmieri are not subject to changes or cancellation by Purchaser without the written consent of Palmieri. In such cases where Palmieri authorizes changes or cancellation, Palmieri reserves the right to charge the Purchaser with reasonable costs based upon expenses already incurred and commitments made by Palmieri, including, without limitation, any labour done, material purchased and also including Supplier's usual overhead and reasonable profit and cancellation charges from Palmieri's suppliers. Palmieri will communicate to the Purchaser additional costs incurred by way of Revised Order Confirmation. Revised Order Confirmation will include applicable costs incurred and modification to lead times (if applicable). The Purchaser must provide Palmieri written confirmation of additional costs, before any changes can be processed on the order.

A minimum charge of \$100.00 NET Change Order Request fee will apply

A minimum charge of \$150.00 NET Cancel Order Request fee will apply.

9. SHIPPING LOCATION / SHIPPING QUOTES / COST OF TRANSPORTATION

Unless otherwise stated, all prices are F.O.B. our factory in Richmond Hill, Ontario, Canada.

Customary methods of transportation shall be selected by Palmieri and such transportation will be at Purchaser's expense. Shipping quotations are made at time of furniture quotation and are outside the control of Palmieri. **Shipping quotes are valid for ten (10) business days from the time of quote.** We do our best to maintain shipping costs as quoted, however all shipping weights and cubic feet shown are approximate only, various construction materials and packaging methods may add to the weights given. All quoted prices, unless otherwise stated on the quotation, are based on the current exchange rates, tariffs, fuel surcharges and costs of manufacture and are subject to change by Palmieri with or without notice until Purchaser's acceptance. Palmieri does not assume responsibility or liability for shipping costs, product during transit, or variances from the shipping weights or cubic feet shown in our specification guides. Special methods of transportation will be used upon Purchaser's request and at Purchaser's additional expense, provided reasonable notice of Purchaser's transportation requirements are given by Purchaser to Palmieri prior to shipment. Palmieri will notify the client prior to shipping product if shipping costs as quoted change, at which point the client must approve the adjusted shipping costs.

10. RECEIVING PRODUCT / REPORTING DAMAGE / STORAGE OF PRODUCT

Upon receipt of Palmieri product, the receiver of the goods must immediately inspect the product to ensure it is free of shipping damage. If the product is deemed in good order, the receiver of the product must ensure

to sign off on the accompanying carriers Bill of lading in good condition. Except for obligations stated under "Warranty" herein, Palmieri' responsibility for the product ceases once the product has been received and signed off in good order and is the full responsibility of the receiver and subsequently the owner.

In the event shipping damage is discovered during receipt of shipment, it is the responsibility of the receiver to ensure all noted damage is recorded on the carrier's Bill of Lading prior to sign off. All noted shipping damage claims must be reported to Palmieri within **24 hours** of receipt of the product onsite, failure to do so will result in the claim being deemed null and void. All shipping damage claims are to be reported directly to Palmieri's Shipping Manager. Please call our toll free number at **1-800-413-4440 ext. 33** or submit the claim by Fax directly to **1-905-731-9878**. Palmieri will not accept any shipping damage claims submitted **after 24 hours** and it shall be conclusively presumed that the goods were delivered in good condition.

Storage of product, Palmieri will not be held responsible for any potential damages or shortages for product shipped and received by Purchaser and is subsequently placed into storage and not inspected within 24 hours of receipt.

11. INSTALLATION / SHORTAGES / BACK CHARGES

Unless otherwise expressly stipulated, the goods shall be installed by and at the risk and expense of Purchaser.

In the event that Palmieri is requested to supervise such installation, Palmieri's responsibility shall be limited to exercising that degree of skill customary in the trade in supervising installations of the same type. Purchaser shall remain responsible for all other aspects of the work including compliance with the local regulations. It is the responsibility of the Purchaser to ensure hardware and parts are received in good order. Packing slip and hardware list to be provided by Palmieri with every order at time of shipping. Purchaser has the responsibility to notify Palmieri immediately without delay of issues that arise; subsequently Palmieri will take action to provide prompt resolution.

Shortages must be reported to Palmieri within **24 hours** of receipt of the goods and failure to do so may be at the expense of the Purchaser.

If deemed missing hardware and parts short shipped from the factory, Palmieri will arrange to ship freight prepaid to destination. Palmieri will only be responsible for replacement costs of missing hardware and parts, any labour costs incurred will be the responsibility of the Purchaser and will not be approved by Palmieri.

Back Charges will only be approved if we deemed a defect in the material or workmanship is found during the installation period resulting in a return trip to the job-site to complete installation. It shall remain the sole discretion of Palmieri to approve (A) repair or (B) replace the furniture and any labour costs incurred by the Purchaser.

12. FORCE MAJEURE

Palmieri shall not be responsible or liable for any loss or damage incurred by Purchaser herein resulting from causes beyond the reasonable control of Palmieri including, but without limitation, abuse, misuse or accident, alteration or modification of product by customer or third party, normal wear and tear, improper installation, handling or incorrect use, unauthorized repairs, the substitution of part components or hardware not approved or authorized by Palmieri, improper storage, and environmental conditions such as irregular temperature control

either inside or outside the environment, acts of God, fire, flood, delays in transportation, or the failure of Palmieri's suppliers to meet their delivery promises. The acceptance of delivery of the goods by Purchaser shall constitute a waiver of all claims for loss or damage due to any delay whatsoever.

13. RETURNED GOODS

No goods may be returned to Palmieri for a credit or exchanged without Palmieri's prior written consent.

Palmieri reserves the right to accept all returns and subject to a handling/restocking charge or to decline all returns. Even after Palmieri has authorized the return of goods for credit, Palmieri reserves the right to adjust the amount of any credit given to Purchaser on return of the goods based on the conditions of the goods on arrival in Palmieri's warehouse. Credit for returned goods will be issued to Purchaser only where such goods are returned by Purchaser and not by any subsequent owner of the goods. Goods will be considered for return only if they are in their original condition and packaging. Palmieri Goods Return Authorization Form to be issued and **must** accompany all shipments returning back to the factory. **Return freight must be prepaid by Purchaser. A minimum 20% re-stocking fee will apply.**

1230 Reid Street
Richmond Hill
Ontario Canada
L4B 1C4

T 905 731 9300
F 905 731 9878
TF 800 413 4440

info@palmierifurniture.com
www.PalmieriFurniture.com

SPECIFICATION GUIDE & PRICE LIST

2017

PALMIERI

GENERAL PRODUCTS

CATEGORY: LIBRARY FURNITURE
CONTRACT: BID #ESCNJ 17/18-16

Table of Contents 2-3

Product Materials & Finishes 4-5

Book Trucks 6-15



Displays & Media 16-27



Picture Book 16-27



Browsers 18-19



Pedestal Display 20-21



Display Towers 22-25



Display Cases % Kiosks 26-27

Teaching Board 28-29



Lecterns 28-29



Dictionary Stands & Map Cases 30-31



Electrical 32-41



Warranty 42

Terms & Conditions 43

WOODS & FINISHES:

Natural Maple Standard

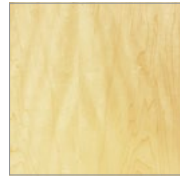

Natural Clear – M-NA

Maple Finishes

The following stains are available, add 10% to list

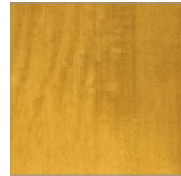

Castle Oak – M-CO

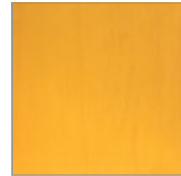

Honey Oak – M-HO

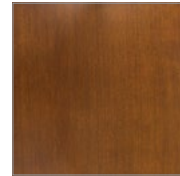

English Oak – M-EN

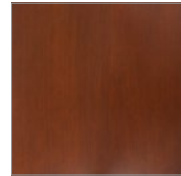

Victorian Cherry – M-VI

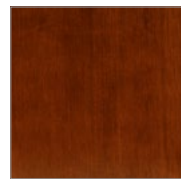

Richmond Cherry – M-RC

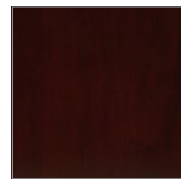

Mahogany – M-MA



Java – M-JA



Wenge – M-WE

Natural Red Oak Standard

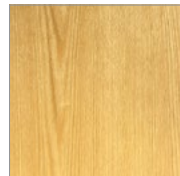

Natural Clear – O-NA

Red Oak Finishes

The following stains are available, add 10% to list

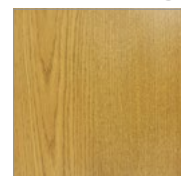

Castle Oak – O-CO

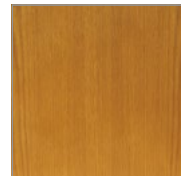

Honey Oak – O-HO

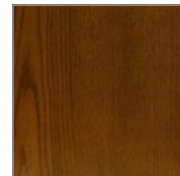

English Oak – O-EN



Victorian Cherry – O-VI

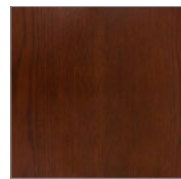

Richmond Cherry – O-RC



Mahogany – O-MA



Java – O-JA



Wenge – O-WE

Natural Cherry Add 20% to list

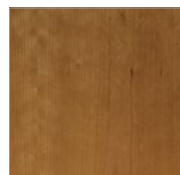

Natural Clear – C-NA

Cherry Finishes

The following stains are available, add 30% to list



Honey Oak – C-HO



Richmond Cherry – C-RC

Natural Walnut Add 20% to list

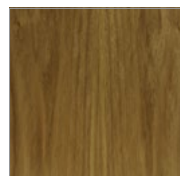

Natural Clear – W-NA

Walnut Finishes

The following stain is available, add 30% to list



Java – W-JA

METAL PAINT:

Thermal Paint Colours

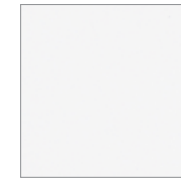

White
PS-111-W374



Antique White
W11



Beige
H23

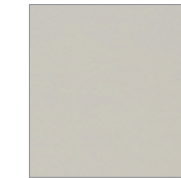

Desert
H432

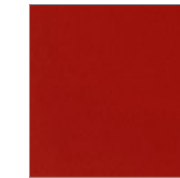

Red
R66



Ruby
R7



Blue
B11



Navy
B17

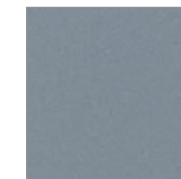

Zinc
A67

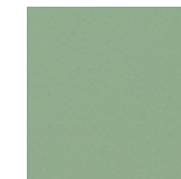

Hydro Green
G96



Green
G58



Grey
A16



Charcoal
A230



Black
N49



Pebble
M237



Black Sandtex
N31

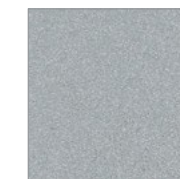

Sparkling Silver
S11





Champagne
S14





HARDWOODS: All hardwood materials used in the manufacturing of Palmieri products shall be Northern grown hardwoods. Hardwoods will be air and kiln dried to a moisture content of 5-7%. All hardwoods shall be of grade "A" material, free of material stains, imperfections, conformity of grain, texture and color. Hardwood species shall be Northern grown Red Oak, Clear White Northern Maple and Birch. American Cherry and Honduras Mahogany and Walnut are available. Please inquire for pricing.





FINISHING PROCEDURES: All materials shall be inspected and treated with a final sanding and polishing operation before any staining and final finishing can be performed. All machine and mill marks are to be removed. Once the polishing and sanding has been performed, the furniture will then undergo the following stain and finishing procedures:





- Step 1 A base stain will be uniformly applied, wiped and then allowed to dry under factory controlled conditions.
- Step 2 A uniform coat of sealer will be applied and allowed to dry.
- Step 3 Sealer will be lightly sanded using 240 grit silicon paper.
- Step 4 A catalytic lacquer of 34-45 degree sheen is evenly applied and allowed to dry under factory controlled conditions.

METAL FINISHING PROCEDURES: All metal components are thoroughly cleaned and coated electrostatically with an epoxy powder coat paint finish. The metal components are then oven baked and cured for a lasting finish.







	MODEL NUMBER	PRODUCT	WIDTH	DEPTH	HEIGHT	WEIGHT	VOLUME	PRICE	DESCRIPTION
	BT-100-39	Book Return Truck	25 ¹ / ₄ "	23 ¹ / ₂ "	31 ³ / ₄ "	90 Lbs.	12 Cu.Ft.	\$ 3,369	Fits into Linx and Gemini Desk System Book Return Units, LX-208 and GS-208. Unit constructed from 3/4 plywood, assembled together by means of tongue and groove assembly. Descending platform will be of veneer. Platform will be mounted to a coiled tension spring that will descend as books are dropped off and ascend as they are removed. 4 diameter swivel casters are mounted to the underside of the truck.
	BT-100-32	Book Return Truck Small	25 ¹ / ₄ "	23 ¹ / ₂ "	26 ³ / ₄ "	80 Lbs.	11 Cu.Ft.	\$ 3,369	
	BT-101	Depressible Book Truck with Lid	25 ¹ / ₄ "	23 ¹ / ₂ "	36 ³ / ₄ "	120 Lbs.	16 Cu.Ft.	\$ 3,869	Used for after hour drop-offs. Unit constructed from 3/4" plywood, assembled together by means of tongue and groove assembly. Descending platform will be of veneer. Platform will be mounted to a coiled tension spring that will descend as books are dropped off and ascend as they are removed. Locking lid 25-1/2" wide x 23-1/2" long x 8" high constructed from 3/4" plywood. Top surface laminated. Assembled by means of tongue and groove assembly. Book return slot is 14" wide x 3" high, banded on all four edges. Unit comes complete with lock. 4" diameter swivel casters are mounted to the underside of the truck.
	BT-102	Wood Truck with 3 Flat Shelves	32 ¹ / ₄ "	15 ¹ / ₂ "	37"	65 Lbs.	11 Cu.Ft.	\$ 1,194	Constructed from 3/4" 3-ply plywood. End panels banded on all sides with 1/2" solid, edges to be radiused 3/8". Bottom constructed as end panels, 1/4" solid external banding on long sides only, edges eased. Shelves constructed from 3/4" 3-ply plywood. Clearance between shelves will be 12-1/8". End panels, shelves and bottom are fastened together by means of 3" long pan head bolts passing through end panels and into metal fasteners imbedded in the underside of the bottom and shelves. Two, 3/4" thick x 4" wide reinforcing rails are mounted to the underside of the bottom. 4" Diameter casters are mounted to the reinforcing rails.
	BT-102X	Oversize Wood Truck with 3 Flat Shelves	38"	17"	39"	70 Lbs.	12 Cu.Ft.	\$ 1,231	Constructed from 3/4" solid maple or solid oak. End panel edges to be radiused 3/8". Bottom constructed as end panels, bottom edges to be eased. Clearance between shelves will be 12-3/4". End panels, shelves and bottom are fastened together by means of 3" long pan head bolts passing through end panels and into metal fasteners imbedded in the underside of the bottom and shelves. Two, 3/4" thick x 4" wide reinforcing rails are mounted to the underside of the bottom. 4" Diameter casters are mounted to the reinforcing rails.





	MODEL NUMBER	PRODUCT	WIDTH	DEPTH	HEIGHT	WEIGHT	VOLUME	PRICE	DESCRIPTION
	BT-103	Wood Display Truck, Double Sided	32 1/4"	15 1/2"	37"	65 Lbs.	11 Cu.Ft.	\$ 1,338	Display book truck has 4 sloping display shelves. Constructed from 3/4" 3-ply plywood. End panels banded on all sides with 1/2" solid, edges to be radiused 3/8". Bottom constructed as end panels, 1/4" solid external banding on long sides only, edges eased. Shelves constructed from 3/4" 3-ply plywood. Clearance between shelves will be 11-1/2". End panels, shelves and bottom are fastened together by means of 3" long pan head bolts passing through end panels and into metal fasteners imbedded in the underside of the bottom and shelves. Two, 3/4" thick x 4" wide reinforcing rails are mounted to the underside of the bottom. 4" Diameter casters are mounted to the reinforcing rails.
	BT-103X	Oversize Display Truck, Double Faced	38"	17"	39"	70 Lbs.	12 Cu.Ft.	\$ 1,394	Display book truck has 4 sloping display shelves. Constructed from 3/4" solid maple or solid oak. End panel edges to be radiused 3/8". Bottom constructed as end panels, edges eased. Clearance between shelves will be 13". End panels, shelves and bottom are fastened together by means of 3" long pan head bolts passing through end panels and into metal fasteners imbedded in the underside of the bottom and shelves. Two, 3/4" thick x 4" wide reinforcing rails are mounted to the underside of the bottom. 4" Diameter casters are mounted to the reinforcing rails.
	BT-104	Wood Display Truck, Single Sided	32 1/4"	15 1/2"	37"	65 Lbs.	11 Cu.Ft.	\$ 1,406	Display book truck has 2 single sided sloping display shelves. Constructed from 3/4" 3-ply plywood. End panels banded on all sides with 1/2" solid, edges to be radiused 3/8". Bottom constructed as end panels, 1/4" solid external banding on long sides only, edges eased. Shelves constructed from 3/4" 3-ply plywood. Clearance between shelves will be 11-1/2". End panels, shelves and bottom are fastened together by means of 3" long pan head bolts passing through end panels and into metal fasteners imbedded in the underside of the bottom and shelves. Two, 3/4" thick x 4" wide reinforcing rails are mounted to the underside of the bottom. 4" Diameter casters are mounted to the reinforcing rails.
	BT-104X	Oversize Wood Display Truck, Single Faced	38"	17"	39"	70 Lbs.	12 Cu.Ft.	\$ 1,431	Display book truck has 2 single sided sloping display shelves. Constructed from 3/4" solid maple or solid oak. End panel edges to be radiused 3/8". Bottom constructed as end panel edges eased. Clearance between shelves will be 13". End panels, shelves and bottom are fastened together by means of 3" long pan head bolts passing through end panels and into metal fasteners imbedded in the underside of the bottom and shelves. Two, 3/4" thick x 4" wide reinforcing rails are mounted to the underside of the bottom. 4" Diameter casters are mounted to the reinforcing rails.



	MODEL NUMBER	PRODUCT	WIDTH	DEPTH	HEIGHT	WEIGHT	VOLUME	PRICE	DESCRIPTION
	BT-277	Steel Display Truck, Single Sided	32"	16 1/2"	43"	65 Lbs.	11 Cu.Ft.	\$ 831	Metal frames constructed from 1" x 1" 16 gauge tubing. Tubing spot welded to panels and shelves. Panels and shelves constructed from 18 gauge sheet metal. 2 sloping shelves 14-3/4" deep x 6" high with 12" clearance between each shelf. Book truck fitted with inserts to accept 4" diameter polyflex casters. Book truck finished in a baked enamel finish: Antique White – W11 as a standard color. Other colors available upon request (upcharge).
	BT-312	Steel Truck with 3 Flat Shelves	32"	16 1/2"	43"	65 Lbs.	11 Cu.F.	\$ 831	Metal frames constructed from 1" x 1" 16 gauge tubing. Tubing spot welded to panels and shelves. Panels and shelves constructed from 18 gauge sheet metal. 3 flat shelves complete with 12" clearance between each shelf. Book truck fitted with inserts to accept 4" diameter polyflex casters. Book truck finished in a baked enamel finish: Antique White – W11 as a standard color. Other colors available upon request (upcharge).
	BT-312-A	Steel Display Truck, Double Sided	32"	16 1/2"	43"	65 Lbs.	11 Cu.Ft	\$ 900	Metal frames constructed from 1" x 1" 16 gauge tubing. Tubing spot welded to panels and shelves. Panels and shelves constructed from 18 gauge sheet metal. 4 sloping shelves back to back each at a 90 degree angle - 6-1/2" deep x 6-1/4" high with 12" clearance between each shelf. Book truck fitted with inserts to accept 4" diameter polyflex casters. Book truck finished in a baked enamel finish: Antique White – W11 as a standard color. Other colors available upon request (upcharge).
	BT-313	Steel Display Book Buddy Truck, Double Sided	32"	16 1/2"	43"	65 Lbs.	11 Cu.Ft	\$ 988	Metal frames constructed from 1" x 1" 16 gauge tubing. Tubing spot welded to panels and shelves. Panels and shelves constructed from 18 gauge sheet metal. Top flat shelf: 16" deep x 3-1/4" high back lip. Bottom picture book compartment is 24-3/4" high with 4 fixed dividers 6" apart. Book truck fitted with inserts to accept 4" diameter polyflex casters. Book truck finished in a baked enamel finish: Antique White – W11 as a standard color. Other colors available upon request (upcharge).

	MODEL NUMBER	PRODUCT	WIDTH	DEPTH	HEIGHT	WEIGHT	VOLUME	PRICE	DESCRIPTION
	BT-316	Steel Book Buddy Truck with 3 Flat Shelves	32"	16 1/2"	43"	65 Lbs.	11 Cu.Ft.	\$ 1,206	Metal frames constructed from 1" x 1" 16 gauge tubing. Tubing spot welded to panels and shelves. Panels and shelves constructed from 18 gauge sheet metal. 3 flat shelves complete with 12" clearance between each shelf. Book truck fitted with inserts to accept 4" diameter polyflex casters. Book truck finished in a baked enamel finish: Antique White – W11 as a standard color. Other colors available upon request (upcharge).
	BT-316-A	Steel Display Book Buddy Truck, Double Sided	32"	16 1/2"	43"	65 Lbs.	11 Cu.F.	\$ 1,206	Metal frames constructed from 1" x 1" 16 gauge tubing. Tubing spot welded to panels and shelves. Panels and shelves constructed from 18 gauge sheet metal. 4 sloping shelves back to back each at a 90 degree angle - 6-1/2" deep x 6-1/4" high with 12" clearance between each shelf. Book truck fitted with inserts to accept 4" diameter polyflex casters. Book truck finished in a baked enamel finish: Antique White – W11 as a standard color. Other colors available upon request (upcharge).
	BT-ST1	Steer 1 Book Truck	32"	16 1/2"	43"			\$ 1,394	Metal frames constructed from 1" x 1" 16 gauge tubing. Tubing spot welded to panels and shelves. Panels and shelves constructed from 18 gauge sheet metal. 3 flat shelves complete with 12" clearance between each shelf. Sides are fitted with wood veneer panels. Book truck fitted with inserts to accept 4" diameter polyflex casters. Book truck finished in a baked enamel finish.
	BT-ST2	Steer 2 Book Truck	43"	16 1/2"	43"			\$ 1,900	Metal frames constructed from 1" x 1" 16 gauge tubing. Constructed from 3/4" 3-ply plywood. End panels banded on all sides with 1/2" solid, edges to be radiused 3/8". Bottom constructed as end panels, 1/4" solid external banding on long sides only, edges eased. Shelves constructed from 3/4" 3-ply plywood. Clearance between shelves will be 12-1/8". End panels, shelves and bottom are fastened together by means of 3" long pan head bolts passing through end panels and into metal fasteners imbedded in the underside of the bottom and shelves. Two, 3/4" thick x 4" wide reinforcing rails are mounted to the underside of the bottom. 4" Diameter casters are mounted to the reinforcing rails.



	MODEL NUMBER	PRODUCT	WIDTH	DEPTH	HEIGHT	WEIGHT	VOLUME	PRICE	DESCRIPTION
	BT-ST3-O	Steer 3 Book Truck	43"	16 1/2"	43"	65 Lbs.	11 Cu.Ft.	\$ 2,106	Metal frames constructed from 1" x 1" 16 gauge tubing. Display book truck has 4 sloping display shelves. Constructed from 3/4" 3-ply plywood. End panels banded on all sides with 1/2" solid, edges to be radiused 3/8". Bottom constructed as end panels, 1/4" solid external banding on long sides only, edges eased. Shelves constructed from 3/4" 3-ply plywood. Clearance between shelves will be 11-1/2". End panels, shelves and bottom are fastened together by means of 3" long pan head bolts passing through end panels and into metal fasteners imbedded in the underside of the bottom and shelves. Two, 3/4" thick x 4" wide reinforcing rails are mounted to the underside of the bottom. 4" Diameter casters are mounted to the reinforcing rails.
	BT-ST4-O	Steer 4 Book Truck	42"	16 1/2"	42"			\$ 1,406	Metal Frame, Wood Shelves. Shelf Depth: 15.5". 2 Fixed Shelves: 13" space apart. Frame: 1" x 1" powder coat paint. Book Capacity: Approx. 210
	BT-ST5-O	Steer 5 Book Truck	19"	21"	44"			\$ 2,481	Metal Frame, Wood Bookcase. Wood Bookcase: 9"d x 17"w x 36"h. 2 Shelves: 1 fixed, and 1 adjustable. Frame: 1" diameter, powder coat paint. Book Capacity: Approx. 55
	BT-LC	Locking Casters (Set of 2)				1.5 Lbs.		\$ 56	2 Locking caster - 2 swivel
	BT-5C	5" Diameter Casters (Set of 4) *Upcharge from 4" Casters				1.6 Lbs.		\$ 56	5" Diameter casters upcharge from 4" casters
	BT-RB	Rubber Bumpers (Set of 4)				4 Lbs.		\$ 281	24" Long reinforced steel rubber bumpers mounted to each corner of the book truck - beige color only. NOTE: Bumpers available only on wood book trucks as an option.





	MODEL NUMBER	PRODUCT	WIDTH	DEPTH	HEIGHT	WEIGHT	VOLUME	PRICE	DESCRIPTION
	DP-S-109	Single Picture Book Box	30 ¹ / ₄ "	10"	15 ¹ / ₂ "	30 Lbs.	4 Cu.Ft.	\$ 738	Constructed from 3/4" 3-ply high density particleboard, grade "A" veneer faces. Top, shelf and bottom routed out 1/4" to receive six 1/4" black painted hardboard dividers.
	DP-S-110	Double Picture Book Box	60 ¹ / ₄ "	10"	30 ¹ / ₄ "	30 Lbs.	8 Cu.Ft.	\$ 1,088	Constructed from 3/4" 3-ply high density particleboard, grade "A" veneer faces. Top, shelf and bottom routed out 1/4" to receive twelve 1/4" black painted hardboard dividers.
	DP-S-111	Base for Picture Book Box	35"	10"	6"	10 Lbs.	2 Cu.Ft.	\$ 494	A solid hardwood apron base 3/4" x 3-3/8" fitted together with metal corner brackets. The base is recessed from the table edge 1-1/2" on four sides. Legs are 1-3/4" x 1-3/4" glued-up solid stock, all edges eased. The leg is then fitted with a hanger bolt to pass through the corner bracket.
	DP-S-909	Mobile Picture Book Box, Trapezoidal	58"	21"	35"	125 Lbs.	32 Cu.Ft.	\$ 2,794	Double sided double tiered unit made from 3/4" 3-ply veneer high density particleboard. Assembled by means of tongue and groove assembly. Front edges banded with 1/4" solid hardwood. Backs constructed from 1/4" thick printed hardboard.
	DP-S-105	Mobile Picture Book Browser with Storage	27"	29"	29"	125 Lbs.	18 Cu.Ft.	\$ 2,644	Constructed from 3/4" thick high density particleboard, veneered grade "A". Sloped trough divides top of unit into four, 14" wide x 12" deep compartments. Display trough is 13-1/2" high. Front opening of unit is 25" wide x 14" high. The top underside and the bottom will be routed to receive eight, 1/2" thick veneered dividers. Each compartment is 4-7/8" wide. 4" casters will be mounted to the underside.
	DP-S-106	Single Sided Picture Book Browser with Storage	35 ¹ / ₄ "	13 ³ / ₄ "	32 ¹ / ₂ "	60 Lbs.	10 Cu.Ft.	\$ 2,531	Constructed from 3/4" 3-ply high density particleboard, grade "A" veneer faces. Two, 3/4" thick plywood dividers divide top into 3 compartments. The end compartments are 13" wide x 12-3/8" deep x 8" high and the middle compartment is 7-3/4" wide. Top edges of dividers banded with 1/4" external hardwood. Front face of unit is 8-7/8" high. Underside of cabinet routed to receive seven, 1/2" thick x 23" high wood veneer dividers.

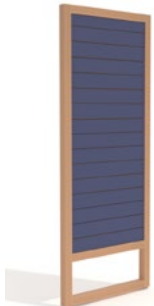



	MODEL NUMBER	PRODUCT	WIDTH	DEPTH	HEIGHT	WEIGHT	VOLUME	PRICE	DESCRIPTION
	DP-S-108	Single Sided Picture Book Browser	43 ¹ / ₂ "	16"	33"	130 Lbs.	13 Cu.Ft	\$ 2,113	Constructed from 3/4" thick high density particleboard core with grade 'A' face veneers. Single faced unit has 3 compartments 13-1/2" wide x 11-7/8" deep. The dividers are fixed. Solid apron base 3/4" x 3-3/8" fitted with metal corner brackets. Legs are 1-3/4" x 1-3/4" solid hardwood, fitted with an adjustable glide.
	DP-S-108D	Double Sided Picture Book Browser	43 ¹ / ₂ "	22"	33"	220 Lbs.	24 Cu.Ft	\$ 2,550	Constructed from 3/4" thick high density particleboard core with grade 'A' face veneers. Double faced has 6 compartment 13-1/2" wide x 11-7/8" deep. The dividers are fixed. Solid apron base 3/4" x 3-3/8" fitted with metal corner brackets. Legs are 1-3/4" x 1-3/4" solid hardwood, fitted with an adjustable glide.
	DP-S-132	Kinder Box	28"	28"	27"	75 Lbs.	16 Cu.Ft	\$ 1,594	Constructed from 3/4" thick 3-ply particleboard core with grade "A" face veneers. Top edges banded with 1/4" solid external hardwood. 3/4" thick veneer faced dividers divide unit into four compartments, each 13" wide x 13" deep x 10" high. Solid base 3/4" thick x 3-3/8" high mounted to underside of unit. Legs are 1-3/4" x 1-3/4" solid hardwood, fitted with an adjustable glide.
	GN-395-A	AV Browser: Adult	39 ³ / ₄ "	18 ¹ / ₂ "	54"	250 Lbs.	22 Cu.Ft	\$ 4,050	Multi media display bins, constructed of 3/4" thick 3-ply particleboard with grade A veneer faces. Each bin is divided into 10 expandable compartments each 3-3/8" wide complete with nine (9) removeable black 1/4" thick masonite dividers. Bottom of bins are lined with black ribbed rubber. The top bin is fixed, whereas the middle and bottom bins pull out, using 16" full extensions slides. In the Children's model the bottom bin pulls out. End panels are constructed of 1" thick 3-ply particleboard with grade A face veneers. All edges banded with 1/4" thick solid external hardwood.
	GN-395-C	AV Browser: Children's	39 ³ / ₄ "	18 ¹ / ₂ "	33 ³ / ₄ "	150 Lbs.	13 Cu.Ft	\$ 3,681	CAPACITY: Adult: 90 videos or 330 compact discs or 390 audio cassettes. Children's: 60 videos or 220 compact discs or 260 audio cassettes.





	MODEL NUMBER	PRODUCT	WIDTH	DEPTH	HEIGHT	WEIGHT	VOLUME	PRICE	DESCRIPTION
	GN-505-5	Pedestal Display Tower: 5-Tier	26"	26"	66 ³ / ₄ "	220 Lbs.	36 Cu.Ft	\$ 5,694	<p>TOP: Constructed in a 3 part assembly. The top and bottom are constructed from 3/4" 3-ply particleboard, complete with veneer faces and 1/4" solid external banding. The fascia top is constructed from 3/4" thick x 23" wide x 23" long x 4" high 3-ply particleboard with all faces laminated with black plastic laminate. The top, mid section and bottom of the top are then assembled together to form one complete top. Underside of top equipped with metal inserts to allow towers to rotate.</p> <p>BASE: Constructed in a 3 part assembly. The top is constructed from 3/4" thick 3-ply particleboard, complete with veneer faces and 1/4" solid external banding. The mid section of the bottom is constructed from 3/4" thick x 23" wide x 23" long x 10" high 3-ply particleboard, assembled together by means of tongue and groove assembly. Outside edges of the mid section to be edged with 1/4" solid external banding. The kick base is 21-1/2" wide x 21-1/2" long x 4" high. All faces of kick to be laminated with black plastic laminate. Bottom equipped with metal inserts to allow towers to rotate.</p> <p>TOWER COLUMN: Constructed from 3/4" thick x 5" wide x 5" long 3-ply particleboard, splined and mitered together. All faces to be veneered. The tower column will be fastened to the top and base of the unit.</p> <p>TOWERS: Individual rotating towers are available in 5 and 6 shelf tiers. Top, bottom and shelves are constructed from 1/2" thick x 10-1/2" x 10-1/2" high density flakeboard, faces veneered. Shelves will be divided into 4 sections by means of 3/8" thick x 3-1/2" solid wood dividers. Each tower will receive four 3/16" thick x 4-1/2" wide acrylic face dividers. Acrylic dividers will be pre-drilled and fastened into the front edges of each shelf. Top and bottom of towers equipped with ball bearing plates.</p> <p>CAPACITIES: 5-Tier: 500 paperbacks 6-Tier: 600 paperbacks</p>
	GN-505-6	Pedestal Display Tower: 6-Tier	26"	26"	66 ³ / ₄ "	220 Lbs.	36 Cu.Ft	\$ 5,825	





	MODEL NUMBER	PRODUCT	WIDTH	DEPTH	HEIGHT	WEIGHT	VOLUME	PRICE	DESCRIPTION
	GN-502-4	Display Tower: 4 Tier (2 Towers Required for Self Supporting)	24 ³ / ₄ "	10 ¹ / ₂ "	48 ⁵ / ₈ "	40 Lbs.	6 Cu.Ft	\$ 1,263	<p>TOWER FRAMES: Constructed from 1-1/3" x 1-3/4" glued-up solid stock. Overall dimensions, 24-3/4" wide x 1-3/4" thick. 4 Tier unit is 48"h and all other units are 62"h. Vertical and horizontal posts are pre-drilled and fitted together by means of wood dowels and glue. Each post will receive a threaded diameter cushioned glide. Each tower post will be pre-drilled in order to receive additional towers. Additional towers will be fastened by means of bolt and washer assembly.</p> <p>ROTATING TOWERS: Individual rotating towers are available in 4, 5, and 6 shelf tiers - easily accommodates videos or paperbacks. Top, bottom and shelves are constructed from 1/2" thick x 10-1/2" x 10-1/2" high density flakeboard, faces veneered. Shelves will be divided into 4 sections by means of 3/8" thick x 3-1/2" solid wood dividers. Each tower will receive four 3/16" thick x 4-1/2" wide acrylic face dividers. Acrylic dividers will be pre-drilled and fastened into the front edges of each shelf. Top and bottom of tower frame and rotating tower will be fitted with metal inserts complete with ball bearing swivel plates that will enable the towers to rotate freely and quietly.</p> <p>NOTE: STARTER UNIT MUST BE ORDERED WITH 2 TOWERS TO BE SELF SUPPORTING.</p> <p>CAPACITIES: 4-Tier: 100 paperbacks or 64 videos. Shelf opening 9". 5-Tier: 125 paperbacks or 80 video. Shelf opening 8-15/16". 6-Tier: 150 adult size paperbacks. Shelf opening 7-3/8".</p>
	GN-502-5	Display Tower: 5 Tier (2 Towers Required for Self Supporting)	24 ³ / ₄ "	10 ¹ / ₂ "	62 ⁵ / ₈ "	43 Lbs.	6 Cu.Ft	\$ 1,281	
	GN-502-6	Display Tower: 6 Tier (2 Towers Required for Self Supporting)	24 ³ / ₄ "	10 ¹ / ₂ "	62 ⁵ / ₈ "	43 Lbs.	6 Cu.Ft	\$ 1,306	
 	GN-502-HB	Display Tower: Hanging Bag (2 Towers Required for Self Supporting)	24 ³ / ₄ "	1 ³ / ₄ "	62 ⁵ / ₈ "	30 Lbs.	2 Cu.Ft	\$ 844	Three 3/8" diameter steel rod inserts complete with wood mounting plates.
	GN-502-TF	Display Tower: Tackable Fabric (2 Towers Required for Self Supporting)	24 ³ / ₄ "	1 ³ / ₄ "	62 ⁵ / ₈ "	40 Lbs.	2 Cu.Ft	\$ 1,319	1-1/2" thick panel complete with tackable core material on two faces and wrapped in fabric - see fabric cards for selection. Top and bottom rails constructed from 3/4" x 3/4" solid hardwood. Bottom rail to be predrilled and fitted with dowel inserts. Top and bottom rails grooved out in order to receive







	MODEL NUMBER	PRODUCT	WIDTH	DEPTH	HEIGHT	WEIGHT	VOLUME	PRICE	DESCRIPTION
	GN-502-SW	Display Tower: Slot Wall (2 Towers Required for Self Supporting)	24 ³ / ₄ "	1 ³ / ₄ "	62 ⁵ / ₈ "	90 Lbs.	2 Cu.Ft	\$ 1,769	SLAT WALL Tower: Constructed from 3/4" M.D.F board. Front and back face to be veneered grade A. Also available in Plastic Laminate.
	GN-502-SW-PL	Display Tower: Slot Wall, Plastic Laminate (2 Towers Required for Self Supporting)	24 ³ / ₄ "	1 ³ / ₄ "	62 ⁵ / ₈ "	90 Lbs.	2 Cu.Ft	\$ 1,319	
	GN-502-SH	Sign Holder for Display Tower	20"	³ / ₄ "	4 ¹ / ₂ "	1 Lbs.	0.1 Cu.Ft	\$ 194	1/8" thick plexiglass divider shields.
	GN-502-SWS-8	Slat Wall Display: 8" Shelf	8"	3 ¹ / ₂ "	5 ¹ / ₂ "	1 Lbs.	0.1 Cu.Ft	\$ 81	
	GN-502-SWS-16	Slat Wall Display: 16" Shelf	16"	3 ¹ / ₂ "	5 ¹ / ₂ "	1.5 Lbs	0.2 Cu.Ft	\$ 119	
	GN-502-SWS-32	Slat Wall Display: 32" Shelf	32"	3 ¹ / ₂ "	5 ¹ / ₂ "	2.5 Lbs	0.3 Cu.Ft	\$ 188	





	MODEL NUMBER	PRODUCT	WIDTH	DEPTH	HEIGHT	WEIGHT	VOLUME	PRICE	DESCRIPTION
	GN-155	Display Case, Glass Shelves and Panels	36"	24"	80"	280 Lbs.	42 Cu.Ft	\$ 7,156	CASE CONSTRUCTION: Wood framing constructed from 1-3/4" x 1-3/4" solid. Framing to be routed to receive 1/4" thick glass on all sides. Wood framing shall incorporate glass by means of a tongue and groove assembly. Unit is equipped with sliding glass doors, 3 adjustable glass shelves and a lock. Base constructed from 3/4" veneer paneling, assembled with wood frame by means of tongue and groove assembly. 4" high kick comes complete with black ribbed rubber.
	GN-155-XL	Fluorescent light for Display Case						\$ 900	Fluorescent light complete with diffuser.
	GN-506	Information Kiosk, Cork Panels	24"	24"	73"	150 Lbs.	24 Cu.Ft	\$ 4,306	TOP: Constructed in a 3 part assembly. The top and bottom are constructed from 3/4" 3-ply particleboard, complete with veneer faces and 1/4" solid external banding. The fascia top is constructed from 3/4" thick x 22-1/2" wide x 22-1/2" long x 4-1/2" high 3-ply particleboard with all faces laminated with black plastic laminate. KIOSK: Kiosk constructed with desired panel selection. Cork board faced panels are standard. Black velcro board or white board panels are available as options. Panels assembled together at the 4 corners by means of 1/4" thick x 7/8" x 7/8" solid vertical corner supports. Paneling mounted to sub-bottom. Bottom equipped with rotating plate.
	GN-506-V	Information Kiosk, Velcro Option (Cost per panel)	24"	24"	73"	150 Lbs.	24 Cu.Ft	\$ 219	BASE: Constructed in a 2 part assembly. The bottom is constructed from 3/4" thick x 24" wide x 24" long x 14" high 3-ply particleboard, assembled together by means of tongue and groove assembly. All faces to be veneered. Outside edges of the mid section to be edged with 1/4" solid external banding. One face panel of base to be equipped with cupboard hinges and lock. The kick base is 21" wide x 21" long x 4" high. All faces of kick to be laminated with black ribbed rubber. Bottom mounted with ball bearing rotating plates.
	GN-506-WB	Information Kiosk, White Board Option (Cost per panel)	24"	24"	73"	150 Lbs.	24 Cu.Ft	\$ 331	

	MODEL NUMBER	PRODUCT	WIDTH	DEPTH	HEIGHT	WEIGHT	VOLUME	PRICE	DESCRIPTION
	GN-904	Teaching Board, Mobile	49 ¹ / ₄ "	24"	72 ¹ / ₂ "	125 Lbs.	20 Cu.Ft	\$ 5,656	Unit accommodates a white board, chart paper holder, pull down projector screen and two flip-up display shelves on one side and cork board on the other side. The frame is constructed from 1-1/4" thick x 3-3/4" wide solid hardwood. Unit mounted to a mobile base consisting of a 48" wide x 5-1/4" deep x 1" thick stretcher and two 24" long x 3-1/4" wide x 2" thick solid hardwood legs. Four 4" diameter lockable casters will be fastened to the underside of the legs.
	GN-122	Lectern For Table Top	20 ¹ / ₄ "	12"	13"	15 Lbs.	3 Cu.Ft	\$ 713	Top constructed from 3/4" 3-ply particleboard, faces veneered. Edges banded with 1/4" solid external band. Front edge to receive a 1/2" thick x 1-1/2" high solid retaining lip. Base constructed from 3/4" 3-ply particleboard, all faces veneered. Edges banded with 1/4" solid external band.
	GN-122-A	Lectern: Open Base, Adjustable Up To 48" Height	23 ¹ / ₂ "	15"	38"	75 Lbs.	9 Cu.Ft	\$ 1,850	Top constructed from 3/4" 3-ply particleboard, faces veneered. Edges banded with 1/4" solid external band. Front edge to receive a 1/4" thick x 1-1/4" high solid retaining lip. Top will be mounted to a 2" x 2" solid wood post. Wood post will be enclosed in a 1/2" thick x 3" x 3" wood sleeve, top of sleeve to be banded with 1/4" solid external band. Top will be adjustable from a range of 38" high to 48" high. A solid wood key will allow lectern to be fixed at desired position. Wood sleeve will be fixed to a 1" thick x 6-1/2" x 6-1/2" veneer core plate mounted to a 23-1/2" wide x 15" deep x 3" high base. Base constructed from 3/4" 3-ply particleboard, all faces veneered.
	GN-162	Lectern: Closed Base, Height Adjustable Shelf	23"	16 ¹ / ₂ "	45"	75 Lbs.	10 Cu.Ft	\$ 2,544	Top constructed from 3/4" 3-ply particleboard, faces veneered. Edges banded with 1/4" solid external band. Front edge to receive a 1/2" thick x 2" high solid retaining lip. Top will overhang case by 3/4" on either side. Case constructed from 3/4" 3-ply particleboard, all faces veneered. Assembled by means of tongue and groove. Front edges banded with 1/4" solid external band. Shelf will be 3/4" thick and adjustable from top to bottom. Base 23" wide x 15" deep x 6" high. Constructed from 3/4" solid material, mitered together at the corners and recessed 3/4" on either side.

	MODEL NUMBER	PRODUCT	WIDTH	DEPTH	HEIGHT	WEIGHT	VOLUME	PRICE	DESCRIPTION
	GN-120-S	Revolving Dictionary Stand, Single Faced	21"	12"	9"	14 Lbs.	2 Cu.Ft	\$ 706	Top constructed from 3/4" thick 3-ply particleboard, faces veneered. Edges banded with 1/4" solid external banding. Top to receive a 3/8" thick x 1/2" high solid retaining lip. Top is sloped at a 12 degree angle. Base, 17" wide x 10" deep x 5-1/2" high, constructed of 3/4" particleboard, all faces veneered. A ball bearing swivel plate is mounted to the underside of the base and fixed to a 3/4" thick x 12" wide x 8" deep wood plate.
	GN-120-D	Revolving Dictionary Stand, Double Faced	21"	17"	9"	16 Lbs.	2 Cu.Ft	\$ 1,025	
	GN-905-5	Map Case: 5 Drawer Large	51"	41"	22 ¹ / ₄ "	310 Lbs.	33 Cu.Ft	\$ 4,106	TOP: Constructed from 1" thick 3-ply particleboard core. Top surface with a high pressure laminate sheet, Surrounding edges shall receive a 1/4" x 1-1/4" solid internal edge band. CABINET CONSTRUCTION: Sub top, bottom and side panels constructed from 3/4" veneer plywood. Front edges banded 1/4" external solid, all edges eased. 4" high base comes complete with black ribbed rubber.
	GN-905-10	Map Case: 10 Drawer Large	51"	41"	39 ³ / ₈ "	560 Lbs.	61 Cu.Ft	\$ 7,419	DRAWERS: 5 drawers (10 drawers for model G-905-10) 47" wide x 37" deep x 2" high constructed from 1/2" mahogany veneer core. Drawer front constructed from 3/4" thick x 2" high solid. Drawers operate on 32" long full extension blum slides.
	GN-154	Map Case	39 ¹ / ₂ "	27"	36 ³ / ₈ "	215 Lbs.	24 Cu.Ft	\$ 6,113	CABINET CONSTRUCTION: Top, bottom and side panels constructed from 3/4" veneer plywood, front edges banded 1/4" external solid. Top surface to be a high pressure laminate. DRAWERS: Six drawers 37" wide x 25" deep x 2-13/16" high constructed from 1/2" mahogany veneer core, drawer front constructed from 3/4" x 4" high solid. Drawers operate on 24" long full extension Blum slides. WOOD BASE: A solid apron base 3/4" x 3-3/8" LEG ASSEMBLY: Legs are 1-3/4" x 1-3/4" glued-up solid stock, all edges eased. GLIDES: Each leg shall be fitted with a threaded T-nut to accept a 1-5/8" diameter cushioned glide complete with a 1-1/2" x 3/8" threaded stem.

	MODEL NUMBER	PRODUCT	WIDTH	DEPTH	HEIGHT	WEIGHT	VOLUME	PRICE	DESCRIPTION
	PW-G2D	Grommet: 2" Diameter	2"	2"	3/4"	0.1 Lbs		\$ 106	Black plastic grommet complete with snap on cover. NOTE: Specify location when ordering.
	PW-G3D	Grommet: 3" Diameter	3"	3"	3/4"	0.1 Lbs		\$ 106	Black plastic grommet complete with snap on cover. NOTE: Specify location when ordering.
	PW-G2X3	Grommet: Square 2" x 3"	3"	2"	3/4"	0.1 Lbs		\$ 106	Black ABS plastic, square grommet. Inside dimensions 1-5/8" x 3". Unit complete with snap on cap. NOTE: Specify location when ordering.
	PW-AGS-3D	Grommet: 3" Diameter Access Sleeve	3"	3"	3/4"	0.1 Lbs		\$ 106	Access panel grommet sleeve, used as electrical conduit for wire passage through panels. NOTE: Specify location when ordering.
	PW-RJ11	Telecom Plate: RJ11 Phone						\$ 50	This RJ11 Cat3 connector is a 6-pin design for voice communication only.
	PW-CAT6	Telecom Plate: RJ45 Data						\$ 69	This RJ45 Cat6 connector is an 8-pin design used to accommodate computers up to 100 mH.
	PW-CAT6-2	Telecom Plate: Two RJ45 Data						\$ 94	Two RJ45 Cat6 Data.

	MODEL NUMBER	PRODUCT	WIDTH	DEPTH	HEIGHT	WEIGHT	VOLUME	PRICE	DESCRIPTION
	PW-OWMT-30	Wire Management: Open Channel	30"	1 1/4"	2 1/2"	1 Lbs	0.3 Cu.Ft	\$ 106	Black plastic channel may be screwed or double sided taped to any flat surface.
		Back Mount J-Channel:							
	PW-BMJC-29	29" Long	29"	4 1/2"	3"	4 Lbs	0.4 Cu.Ft	\$ 131	Unit mounts to back panels. Constructed from 16 gauge steel with electrostatically applied powder paint in black. Special length units are available.
	PW-BMJC-32	32" Long	32"	4 1/2"	3"	4 Lbs	0.4 Cu.Ft	\$ 138	
	PW-BMJC-35	35" Long	35"	4 1/2"	3"	4 Lbs	0.4 Cu.Ft	\$ 144	
	PW-BMJC-41	41" Long	41"	4 1/2"	3"	4 Lbs	0.4 Cu.Ft	\$ 150	
PW-BMJC-47	47" Long	47"	4 1/2"	3"	4 Lbs	0.4 Cu.Ft	\$ 156		
		Top Mount J-Channel:							
	PW-TMJC-29	29" Long	29"	4 1/2"	3"	4 Lbs	0.4 Cu.Ft	\$ 131	Unit mounts to underside of table tops and other work surfaces. Constructed from 16 gauge steel, with electrostatically applied powder paint in black. Special length units are available.
	PW-TMJC-32	32" Long	32"	4 1/2"	3"	4 Lbs	0.4 Cu.Ft	\$ 138	
	PW-TMJC-35	35" Long	35"	4 1/2"	3"	4 Lbs	0.4 Cu.Ft	\$ 144	
	PW-TMJC-41	41" Long	41"	4 1/2"	3"	4 Lbs	0.4 Cu.Ft	\$ 150	
PW-TMJC-47	47" Long	47"	4 1/2"	3"	4 Lbs	0.4 Cu.Ft	\$ 156		
	PW-VWM	Wire Management: Vertical	2"	2"		2 Lbs	0.2 Cu.Ft	\$ 156	Wood vertical wire manager can be located above or below the work surface. Mounted on inside corner of study carrels or circulation desk modules. Available up to 39" high. Specify size required when ordering.
	PW-SLWM	Wire Management: Steel Leg	2 1/2"	2 1/2"		5 Lbs	0.5 Cu.Ft	\$ 388	Steel leg wire manager constructed from 2-1/2" diameter, 16 gauge steel with electrostatically applied powder paint. Top and bottom of leg to receive cut outs to allow cord to feed through top of leg and exit through the bottom. Leg comes complete with leveller. Available up to 39" high. Specify size required when ordering.
	PW-WLWM	Wire Management: Wood Leg	2 3/8"	2 3/8"		5 Lbs	0.5 Cu.Ft	\$ 400	Wood leg wire manager constructed from 2-3/8" x 2-3/8" solid hardwood. Leg mounted to a 1/4" thick steel plate. Top and bottom of leg to receive cut outs to allow cord to feed through top of leg and exit through the bottom. Leg comes complete with leveller. Available up to 39" high. Specify size required when ordering.

	MODEL NUMBER	PRODUCT	WIDTH	DEPTH	HEIGHT	WEIGHT	VOLUME	PRICE	DESCRIPTION
	PW-SPC-4	Power Bar: 4 Outlet	2"	1"	12"	1 Lbs	0.1 Cu.Ft	\$ 156	Slimline power column 4 or 6 receptacle. Power columns are rated 15 Amp, 125 Volts A.C. and feature a resettable 15 Amp circuit breaker. Units have a 3' cord, a switch and indicator light. UL listed and CSA approved. NOTE: Units cannot be interconnected.
	PW-SPC-6	6 Outlet	2"	1"	15"	1 Lbs	0.1 Cu.Ft	\$ 156	
	PW-PCD3-13	Corner Power Column: 3 Outlet, 13" Tall	4 1/4"	1 7/8"	13"	3 Lbs	0.3 Cu.Ft	\$ 475	Unit constructed of heavy gauge galvanized steel with electrostatically applied black powder paint. Assembly comes complete with 3 or 4 grounded receptacles, a 72" cordset with 15 Amp plug and a blank data plate. See telecom section for connector options - ordered separately. NOTE: Units cannot be interconnected.
	PW-PCD3-16	16" Tall	4 1/4"	1 7/8"	16"	3 Lbs	0.3 Cu.Ft	\$ 475	
	PW-PCD4-20	Corner Power Column: 4 Outlet, 20" Tall	4 1/4"	1 7/8"	20"	4 Lbs	0.5 Cu.Ft	\$ 538	
	P-PDS-B	Power Sphere: 2 outlets, 2 data Black	3 3/8"	3 3/8"	1 3/4"	5 Lbs	0.2 Cu.Ft	\$ 269	Unit retrofits into a 3" diameter grommet hole. 15 Amp plug configuration. Provides two simplex outlets and two data communication adapters RJ45 Cat6. 72" Power cord with 15 Amp plug provides direct plug in power. Unit is UL Listed and CSA Approved. Note: Unit cannot be interconnected.
	PW-100J	Junior Flip Up Power Station: Cordset	5 3/4"	5 3/8"				\$ 550	Junior Flip up unit constructed from heavy gauge steel. An easy lift hinge allows cover to be flush with work surface when not in use. Unit complete with 2 power receptacles 15 AMP/125 Volt and 2 data Cat6 connectors. Other power and data configurations are available. Standard finish is black textured. A 72" power cord is provided.
	PW-100F	Flip Up Power Station: Cordset	9	5 3/8"		5 Lbs	0.2 Cu.Ft	\$ 669	Recessed power station unit constructed from heavy gauge steel. An easy lift hinge allows cover to be flush with work surface when not in use. Unit complete with 2 power receptacles 15 AMP/125 Volt and 2 data Cat6 connectors. Other power and data configurations are available. Standard finish is black textured. Unit may be interconnected through a 15 Amp simplex receptacle located on the underside of the unit. A 15 Amp 125 Volt circuit breaker insures overload protection. A 72" power cord is provided.
	PW-100H	Flip Up Power Station: Hard Wired	9	5 3/8"		5 Lbs	0.2 Cu.Ft	\$ 669	Recessed power station unit constructed as above - no interconnected 15 Amp simplex receptacle, replaced by 72" of 14 A.W.G. 3 conductors for hard wiring to main power source.

MODEL NUMBER	PRODUCT	WIDTH	DEPTH	HEIGHT	WEIGHT	VOLUME	PRICE	DESCRIPTION	
	PA-20 System: Wire Manager								
P20-WM-29	29" Long	29"	4"	5 1/2"	5 Lbs	0.4 Cu.Ft	\$ 288	Unit is designed to function as a wire raceway when receptacles are not required. Removeable isolation compartment provides protection from EMI to voice and data lines. Comes complete with a blank data plate. See Telecommunications section for connector options. Mounting holes are provided for future installation of power modules. Constructed from 18 gauge steel with electrostatically applied powder paint. Back mount design.	
P20-WM-32	32" Long	32"	4"	5 1/2"	5 Lbs	0.4 Cu.Ft	\$ 300		
P20-WM-35	35" Long	35"	4"	5 1/2"	5 Lbs	0.4 Cu.Ft	\$ 313		
P20-WM-41	41" Long	41"	4"	5 1/2"	5 Lbs	0.4 Cu.Ft	\$ 331		
P20-WM-47	47" Long	47"	4"	5 1/2"	5 Lbs	0.4 Cu.Ft	\$ 344		
	PA-20 System: 1 Triplex Wire Manager, 8 Wire - 3 Circuit								
P20-1TWM-19-83	19" Long	19"	4"	5 1/2"	8 Lbs	0.4 Cu.Ft	\$ 600	The powered wire management system is available in an 8 wire 3 circuit or an 8 wire 4 circuit system. The raceway housing is constructed from 18 gauge galvanized steel with electrostatically applied black powder paint. The assembly comes complete with 1 triplex power modules either 3 or 4 circuits and 3 simplex receptacles. The receptacles can be configured to activate any of the system's circuits. Each simplex receptacle may be removed and interchanged in various positions utilizing its own circuit without having to change wiring. An authorized simplex removal tool PW-2000 (sold separately) prevents unauthorized access. The system is rated at 20 Amps with each receptacle at 15 Amps. Interconnecting cable is included. Removeable isolation compartment provides protection from EMI to voice and data lines. Comes complete with a blank data plate. See telecom section for connector options - ordered separately. Back mount design.	
P20-1TWM-29-83	29" Long	29"	4"	5 1/2"	8 Lbs	0.4 Cu.Ft	\$ 631		
P20-1TWM-32-83	32" Long	32"	4"	5 1/2"	8 Lbs	0.4 Cu.Ft	\$ 644		
P20-1TWM-35-83	35" Long	35"	4"	5 1/2"	8 Lbs	0.4 Cu.Ft	\$ 756		
P20-1TWM-41-83	41" Long	41"	4"	5 1/2"	8 Lbs	0.4 Cu.Ft	\$ 769		
P20-1TWM-47-83	47" Long	47"	4"	5 1/2"	8 Lbs	0.4 Cu.Ft	\$ 775		
	8 Wire - 4 Circuit								
P20-1TWM-19-84	19" Long	19"	4"	5 1/2"	8 Lbs	0.4 Cu.Ft	\$ 600		
P20-1TWM-29-84	29" Long	29"	4"	5 1/2"	8 Lbs	0.4 Cu.Ft	\$ 631		
P20-1TWM-32-84	32" Long	32"	4"	5 1/2"	8 Lbs	0.4 Cu.Ft	\$ 644		
P20-1TWM-35-84	35" Long	35"	4"	5 1/2"	8 Lbs	0.4 Cu.Ft	\$ 756		
P20-1TWM-41-84	41" Long	41"	4"	5 1/2"	8 Lbs	0.4 Cu.Ft	\$ 769		
P20-1TWM-47-84	47" Long	47"	4"	5 1/2"	8 Lbs	0.4 Cu.Ft	\$ 775		
	PA-20 System: 2 Triplex Wire Manager 8 Wire - 3 Circuit								
P20-2TWM-29-83	29" Long	29"	4"	5 1/2"	8 Lbs	0.4 Cu.Ft	\$ 756		NOTES about PA-20 Systems: *The 8/3 and 8/4 systems are not interchangeable. *Any electrical component specified as a 20 Amp will not function in a regular 15 Amp plug configuration. *Electrical components or assemblies without a cordset and plug must be hard wired to the building's power supply by a qualified electrician. *PA-20 Systems are UL and CSA approved.
P20-2TWM-32-83	32" Long	32"	4"	5 1/2"	8 Lbs	0.4 Cu.Ft	\$ 769		
P20-2TWM-35-83	35" Long	35"	4"	5 1/2"	8 Lbs	0.4 Cu.Ft	\$ 881		
P20-2TWM-41-83	41" Long	41"	4"	5 1/2"	8 Lbs	0.4 Cu.Ft	\$ 894		
P20-2TWM-47-83	47" Long	47"	4"	5 1/2"	8 Lbs	0.4 Cu.Ft	\$ 900		
	8 Wire - 4 Circuit								
P20-2TWM-29-84	29" Long	29"	4"	5 1/2"	8 Lbs	0.4 Cu.Ft	\$ 756		
P20-2TWM-32-84	32" Long	32"	4"	5 1/2"	8 Lbs	0.4 Cu.Ft	\$ 769		
P20-2TWM-35-84	35" Long	35"	4"	5 1/2"	8 Lbs	0.4 Cu.Ft	\$ 881		
P20-2TWM-41-84	41" Long	41"	4"	5 1/2"	8 Lbs	0.4 Cu.Ft	\$ 894		
P20-2TWM-47-84	47" Long	47"	4"	5 1/2"	8 Lbs	0.4 Cu.Ft	\$ 900		





MODEL NUMBER	PRODUCT	WIDTH	DEPTH	HEIGHT	WEIGHT	VOLUME	PRICE	DESCRIPTION
	PA-20 System: Power Data Column, 3 Outlet,							Unit constructed of heavy gauge galvanized steel with electrostatically applied black powder paint. Assembly comes complete with 3 grounded receptacles, 15 amp circuit breaker, dual connector, connecting cable and a blank data plate. See telecom section for connector options - ordered separately. NOTE: Units cannot be interconnected.
P20-PCD3-13-83	13" tall, 8 Wire - 3 Circuit	4 1/4"	17/8"	13"	2.5 Lbs	0.2 Cu.Ft	\$ 650	
P20-PCD3-16-83	16" tall, 8 Wire - 3 Circuit	4 1/4"	17/8"	16"	2.5 Lbs	0.2 Cu.Ft	\$ 650	
P20-PCD3-13-84	13" tall, 8 Wire - 4 Circuit	4 1/4"	17/8"	13"	2.5 Lbs	0.2 Cu.Ft	\$ 650	
P20-PCD3-16-84	16" tall, 8 Wire - 4 Circuit	4 1/4"	17/8"	16"	2.5 Lbs	0.2 Cu.Ft	\$ 650	
	PA-20 System: Single Circuit Power Feed,							The single or multi circuit power feed provides electrical power to the initial power module from an external power source. Assembly constructed from heavy gauge galvanized steel with electrostatically applied black powder paint. Unit supplied with a quick connect metal flex cable at one end and a 24" long cord with molded plug at the other end. For multi circuit has a 36" liquid tight flexible non metallic conduit, instead of the 24" long cord.
P20-SCPF-18-83	18" tall, 8 Wire - 3 Circuit	2"	1"	18"	8 Lbs	0.2 Cu.Ft	\$ 506	
P20-SCPF-26-83	26" tall, 8 Wire - 3 Circuit	2"	1"	26"	8 Lbs	0.2 Cu.Ft	\$ 544	
P20-SCPF-36-83	36" tall, 8 Wire - 3 Circuit	2"	1"	36"	8 Lbs	0.2 Cu.Ft	\$ 613	
P20-SCPF-18-84	18" tall, 8 Wire - 4 Circuit	2"	1"	18"	8 Lbs	0.2 Cu.Ft	\$ 506	
P20-SCPF-26-84	26" tall, 8 Wire - 4 Circuit	2"	1"	26"	8 Lbs	0.2 Cu.Ft	\$ 544	
P20-SCPF-36-84	36" tall, 8 Wire - 4 Circuit	2"	1"	36"	8 Lbs	0.2 Cu.Ft	\$ 613	
	PA-20 System: Multi Circuit Power Feed,							Single Circuit NOTE: The cordset has a 20 Amp plug configuration and cannot be used in a standard 15 Amp receptacle. Multi Circuit NOTE: This unit must be hard wired to the building power source by a qualified and certified electrician.
P20-MCPF-18-83	18" tall, 8 Wire - 3 Circuit	2"	1"	18"	8 Lbs	0.2 Cu.Ft	\$ 588	
P20-MCPF-26-83	26" tall, 8 Wire - 3 Circuit	2"	1"	26"	8 Lbs	0.2 Cu.Ft	\$ 613	
P20-MCPF-36-83	36" tall, 8 Wire - 3 Circuit	2"	1"	36"	8 Lbs	0.2 Cu.Ft	\$ 631	
P20-MCPF-18-84	18" tall, 8 Wire - 4 Circuit	2"	1"	18"	8 Lbs	0.2 Cu.Ft	\$ 588	
P20-MCPF-26-84	26" tall, 8 Wire - 4 Circuit	2"	1"	26"	8 Lbs	0.2 Cu.Ft	\$ 613	
P20-MCPF-36-84	36" tall, 8 Wire - 4 Circuit	2"	1"	36"	8 Lbs	0.2 Cu.Ft	\$ 631	
PW-2000	Authorized Simplex Remover						\$ 19	The authorized simplex remover is a special tool that allows restricted modification of the powered wire management systems to authorized personnel only.
	PA-20 System: Interconnecting Cable,							Interconnecting cables are used to link power outlet starter and add-on modules in a daisy chain configuration. For 8 wire - 3 or 4 Circuit connections.
PW-IC-24-83	24" Long, 8 Wire - 3 Circuit	24"			1 Lbs	0.1 Cu.Ft	\$ 94	
PW-IC-36-83	36" Long, 8 Wire - 3 Circuit	36"			1 Lbs	0.1 Cu.Ft	\$ 100	
PW-IC-48-83	48" Long, 8 Wire - 3 Circuit	48"			1 Lbs	0.1 Cu.Ft	\$ 106	
PW-IC-60-83	60" Long, 8 Wire - 3 Circuit	60"			1 Lbs	0.1 Cu.Ft	\$ 113	
PW-IC-24-84	24" Long, 8 Wire - 4 Circuit	24"			1 Lbs	0.1 Cu.Ft	\$ 94	
PW-IC-36-84	36" Long, 8 Wire - 4 Circuit	36"			1 Lbs	0.1 Cu.Ft	\$ 100	
PW-IC-48-84	48" Long, 8 Wire - 4 Circuit	48"			1 Lbs	0.1 Cu.Ft	\$ 106	
PW-IC-60-84	60" Long, 8 Wire - 4 Circuit	60"			1 Lbs	0.1 Cu.Ft	\$ 113	

NOTES about PA-20 Systems:

*The 8/3 and 8/4 systems are not interchangeable.

*Any electrical component specified as a 20 Amp will not function in a regular 15 Amp plug configuration.

*Electrical components or assemblies without a cordset and plug must be hard wired to the building's power supply by a qualified electrician.

*PA-20 Systems are UL and CSA approved.

Palmieri Furniture Limited ("Palmieri") warrants that its products and collections are free from defects in materials and workmanship for the life of the product, except as set forth below. Palmieri Limited Lifetime Warranty is valid from the date of delivery.

Exceptions to the Limited Lifetime Warranty: Seating: two (2) years

Goods sold hereunder are covered by a Limited Lifetime Warranty, free against defects in material and workmanship provided the goods and services are subjected to normal use and service. The applicable warranty period commences from shipping date to Purchaser of any item of the goods, whichever occurs first, or any other warranty period otherwise stipulated in writing by Palmieri under this sale. For components not supplied by Palmieri, the original manufacturer's warranty shall apply to the extent assignable by Palmieri. The obligation under this warranty is limited to the repair or replacement, at Palmieri's option, of defective parts F.O.B. point of shipment provided that prompt notice of any defect is given by Purchaser to Palmieri in writing within the applicable warranty period and that upon the Purchaser's return of the defective parts to Palmieri or, if designated by Palmieri, to the location where the works are made, properly packed and with transportation charges prepaid by Purchaser, an inspection thereof shall reveal to Palmieri's satisfaction that Purchaser's claim is valid under the terms of this warranty. Purchaser shall assume all responsibility and expense for dismantling, removal, re-installation and freight in connection with the foregoing. The same obligations and conditions extend to replacement parts furnished by Palmieri hereunder.

Palmieri does not assume liability for installation, labour or consequential damages. Palmieri makes no warranty other than the one set forth herein. All other warranties, legal, expressed or implied, including but not limited to any expressed or implied warranty of merchantability, of fitness for the intended use thereof or against infringement are hereby expressly excluded. The applicable warranty ceases to be effective if the goods are altered or repaired other than by persons authorized or approved by Palmieri to perform such work. Repairs or replacement deliveries do not interrupt or prolong the term of the warranty. The warranty ceases to be effective if Purchaser fails to handle and use the goods sold hereunder in a safe and reasonable manner and in accordance with any written instructions from the manufacturers.

Warranty Does Not Apply To Product Failure Or Loss Resulting From:

Abuse, misuse or accident, alteration or modification of product by customer or third party, normal wear and tear, improper installation, handling or incorrect use. The substitution of part components or hardware not approved or authorized by Palmieri, acts of God, unauthorized repairs, improper storage, and environmental conditions such as irregular temperature control either inside or outside the environment.

Warranty Provides Exclusive Remedies:

If a product fails under ordinary use as a result of a defect in material or workmanship, Palmieri will: (A) repair, or (B) replace the furniture. The replacement or repair of the Furniture or Seating will be at the discretion of Palmieri. If the defect or workmanship cannot be remedied on site, repairs can be made at the factory. (C) If the product repair or replacement is not commercially practicable or cannot be remade in a timely manner Palmieri will refund the purchase price of the affected product. A product "**Defect**" means: an inadequacy in the materials or workmanship of the product that (A) existed at the time when you received the product from Palmieri or Palmieri authorized Reseller and (B) causes a failure of the product to perform under ordinary use in accordance with the materials and documentation accompanying the product. "**Ordinary Use**" means: use of the product (A) in accordance with all applicable local, state or federal laws, codes and regulations and (B) in accordance with manufacturer recommendations and or instructions in the materials and documentation accompanying the product or through shop drawings. A "**Palmieri Authorized Reseller**" means: any dealer that is legally permitted to conduct business in the jurisdiction where the product is sold and is duly authorized by Palmieri to sell the product.

Warranty work must be approved by authorized personnel of Palmieri Furniture Limited in Richmond Hill, Ontario, Canada.

A copy of the original purchase order must accompany all claims.

Warranty Does Not Cover:

Matching of colours, stains, textures, grains and any other variations in materials. Select and Custom Surfaces and materials are only warranted for their application on the specified product and are not covered by our warranty, except as warranted by the original supplier, for quality, colorfastness, shade variations or abrasion and textiles purchased for Palmieri product.

This limited warranty is the sole remedy for product defect and no other express or implied warranty is provided. Warranty is not transferable and valid only for the original purchaser acquiring a product from Palmieri or a Palmieri authorized reseller for the purchaser's own use and not for resale, remarketing or distribution. Limited Lifetime Warranty (25 years)

GENERAL

The following Terms and Conditions of Quote and Sale shall apply to any sale of goods and services by Palmieri Furniture Limited (hereinafter called "Palmieri"). Purchaser shall be deemed to have full knowledge of the terms and conditions herein and such terms and conditions shall be binding if either the goods and services referred to herein are delivered to and accepted by Purchaser, or if Purchaser does not within five (5) days from the date hereof deliver to Palmieri written objection to said terms and conditions or any part thereof.

In the event of any conflict or inconsistency between the terms and conditions of sale herein and the terms and conditions contained in Purchaser's order or in any other form issued by Purchaser, whether or not any such form has been acknowledged or accepted by Palmieri, Palmieri's terms and conditions herein shall prevail. No waiver, alteration or modification of these terms and conditions shall be binding upon Palmieri unless made in writing and signed by a duly authorized representative of Palmieri.

1. QUOTATIONS / PRODUCT QUOTED

Unless otherwise stated, **Palmieri's quotations shall be null and void unless accepted by Purchaser within thirty (30) days from the date of quotation.** Quotes may be subject to change before order placement, due to increased material costs and or other factors that could impact the final cost of production and our final understanding of the product required. If the items quoted do not reflect the intended product requirements of the customer, Palmieri will not be held responsible for increased costs for those product changes. We reserve the right to edit or re-quote any portion of a previously submitted quotation subject to our final understanding of the product required by the client.

2. PALMIERI DRAWINGS

Palmieri provides drawings for Custom & Standard product we produce to our clients upon request. We consider these drawings to be Private and Confidential and are provided for the sole purpose and use of our clients to understand the product we are providing. The use of these confidential materials is limited to the transaction between the parties and at no point are these confidential materials to be sent to any of our competitors or parties quoting for the same purpose.

A minimum \$85.00 NET Engineering Administrative Fee will apply for Custom Product Drawings

(Note: The first set of Custom product drawings will be free of charge)

A minimum \$120.00 NET Engineering Administrative Fee will apply for all Standard Product Drawings

3. TERMS OF PAYMENT

For authorized customers; Orders at a \$75,000.00 threshold will require a mandatory 25% deposit. Orders over and above \$100,000.00 requires a mandatory (25%) deposit at time of order, a mandatory (25%) deposit prior to product shipment and the balance to be paid within thirty (30) days of date of shipment. Payment not be made to Palmieri when due, Palmieri reserves the right to charge Purchaser with interest on such overdue payments. Interest of 2% per month (24% per annum) is charged on all overdue accounts, unless otherwise specified. The charging of such interest shall not be construed as obligating Palmieri to grant any extension of time in the terms of payment. All goods remain the property of Palmieri, until balance is paid in full to Palmieri.

4. TITLE

Title to the goods or any part thereof shall not pass from Palmieri to Purchaser until all payments due hereunder have been duly made, except as otherwise expressly stipulated herein. The goods shall be and remain personal or moveable property, notwithstanding their mode of attachment to realty or other property. If default is made in any of the payments herein, Purchaser agrees that Palmieri may retain all payments which have been made on account of the purchase price as liquidated damages, and Palmieri shall be free to enter the premises where the goods may be located and remove them as Palmieri's property, without prejudice to Palmieri's right to recover any further expenses or damages Palmieri may suffer by reason of such nonpayment.

5. TAXES

Prices do not include Goods & Services Tax, Provincial or Municipal sales, use, value-added or similar tax. All applicable taxes are extra. Our Harmonized Sales Tax (HST) registration number is R104055066.

6. THE AGREEMENT

An acceptance and official confirmation of Purchasers' order by signing Palmieri's Order Confirmation the Purchaser therefore is accepting terms and conditions as expressed herein Palmieri's Terms and Conditions of Quote and Sale by Palmieri and shall constitute the complete agreement, subject to the terms and conditions of sale herein set forth, and shall supersede all previous quotations, orders or agreements.

7. LEAD TIME / DELIVERY / DELAYS

Lead time is determined only when final material/finish selection and drawing approvals are received by Palmieri from the client. The accuracy of Palmieri's lead times, is created to the best of our ability with the information provided to us. Confirmed lead time is conveyed to the client by means of Order Confirmation. They do not preclude the client from checking the accuracy of your requirement and our Order Confirmation. Any noted discrepancies are to be reported immediately to Palmieri Customer Service Department for correction and re-issue of revised Order Confirmation. By signing and dating the Order Confirmation the client accepts the terms and conditions of quote and sale.

Lead time on our Order Confirmation do not account for delays that could potentially occur for special materials specified by the client that are outside of our standard finishes and materials program that are out of our control

and will affect the lead time on the order. Palmieri will notify the client immediately when these delays occur and adjust the lead time accordingly.

Delivery schedules are approximate and are based on prevailing market conditions applicable respectively at the time of Palmieri's quotation and Palmieri's acceptance of clients' order, if certain portions of an order are completed by the quoted lead time while other portions have experienced delays outside of our control. The client may choose to part ship the order at their discretion and expense. Otherwise the entire order will ship with the delayed portion at a later date. Palmieri may extend delivery schedules or may, at its option, cancel Purchaser's order in full or in part without liability other than to return any deposit or prepayment which is unearned by reason of the cancellation.

8. CHANGES AND CANCELLATION

Orders accepted by Palmieri are not subject to changes or cancellation by Purchaser without the written consent of Palmieri. In such cases where Palmieri authorizes changes or cancellation, Palmieri reserves the right to charge the Purchaser with reasonable costs based upon expenses already incurred and commitments made by Palmieri, including, without limitation, any labour done, material purchased and also including Supplier's usual overhead and reasonable profit and cancellation charges from Palmieri's suppliers. Palmieri will communicate to the Purchaser additional costs incurred by way of Revised Order Confirmation. Revised Order Confirmation will include applicable costs incurred and modification to lead times (if applicable). The Purchaser must provide Palmieri written confirmation of additional costs, before any changes can be processed on the order.

A minimum charge of \$100.00 NET Change Order Request fee will apply

A minimum charge of \$150.00 NET Cancel Order Request fee will apply.

9. SHIPPING LOCATION / SHIPPING QUOTES / COST OF TRANSPORTATION

Unless otherwise stated, all prices are F.O.B. our factory in Richmond Hill, Ontario, Canada.

Customary methods of transportation shall be selected by Palmieri and such transportation will be at Purchaser's expense. Shipping quotations are made at time of furniture quotation and are outside the control of Palmieri. **Shipping quotes are valid for ten (10) business days from the time of quote.** We do our best to maintain shipping costs as quoted, however all shipping weights and cubic feet shown are approximate only, various construction materials and packaging methods may add to the weights given. All quoted prices, unless otherwise stated on the quotation, are based on the current exchange rates, tariffs, fuel surcharges and costs of manufacture and are subject to change by Palmieri with or without notice until Purchaser's acceptance. Palmieri does not assume responsibility or liability for shipping costs, product during transit, or variances from the shipping weights or cubic feet shown in our specification guides. Special methods of transportation will be used upon Purchaser's request and at Purchaser's additional expense, provided reasonable notice of Purchaser's transportation requirements are given by Purchaser to Palmieri prior to shipment. Palmieri will notify the client prior to shipping product if shipping costs as quoted change, at which point the client must approve the adjusted shipping costs.

10. RECEIVING PRODUCT / REPORTING DAMAGE / STORAGE OF PRODUCT

Upon receipt of Palmieri product, the receiver of the goods must immediately inspect the product to ensure it is free of shipping damage. If the product is deemed in good order, the receiver of the product must ensure

to sign off on the accompanying carriers Bill of lading in good condition. Except for obligations stated under "Warranty" herein, Palmieri's responsibility for the product ceases once the product has been received and signed off in good order and is the full responsibility of the receiver and subsequently the owner.

In the event shipping damage is discovered during receipt of shipment, it is the responsibility of the receiver to ensure all noted damage is recorded on the carrier's Bill of Lading prior to sign off. All noted shipping damage claims must be reported to Palmieri within **24 hours** of receipt of the product onsite, failure to do so will result in the claim being deemed null and void. All shipping damage claims are to be reported directly to Palmieri's Shipping Manager. Please call our toll free number at **1-800-413-4440 ext. 33** or submit the claim by Fax directly to **1-905-731-9878**. Palmieri will not accept any shipping damage claims submitted **after 24 hours** and it shall be conclusively presumed that the goods were delivered in good condition.

Storage of product, Palmieri will not be held responsible for any potential damages or shortages for product shipped and received by Purchaser and is subsequently placed into storage and not inspected within 24 hours of receipt.

11. INSTALLATION / SHORTAGES / BACK CHARGES

Unless otherwise expressly stipulated, the goods shall be installed by and at the risk and expense of Purchaser.

In the event that Palmieri is requested to supervise such installation, Palmieri's responsibility shall be limited to exercising that degree of skill customary in the trade in supervising installations of the same type. Purchaser shall remain responsible for all other aspects of the work including compliance with the local regulations. It is the responsibility of the Purchaser to ensure hardware and parts are received in good order. Packing slip and hardware list to be provided by Palmieri with every order at time of shipping. Purchaser has the responsibility to notify Palmieri immediately without delay of issues that arise; subsequently Palmieri will take action to provide prompt resolution.

Shortages must be reported to Palmieri within **24 hours** of receipt of the goods and failure to do so may be at the expense of the Purchaser.

If deemed missing hardware and parts short shipped from the factory, Palmieri will arrange to ship freight prepaid to destination. Palmieri will only be responsible for replacement costs of missing hardware and parts, any labour costs incurred will be the responsibility of the Purchaser and will not be approved by Palmieri.

Back Charges will only be approved if we deemed a defect in the material or workmanship is found during the installation period resulting in a return trip to the job-site to complete installation. It shall remain the sole discretion of Palmieri to approve (A) repair or (B) replace the furniture and any labour costs incurred by the Purchaser.

12. FORCE MAJEURE

Palmieri shall not be responsible or liable for any loss or damage incurred by Purchaser herein resulting from causes beyond the reasonable control of Palmieri including, but without limitation, abuse, misuse or accident, alteration or modification of product by customer or third party, normal wear and tear, improper installation, handling or incorrect use, unauthorized repairs, the substitution of part components or hardware not approved or authorized by Palmieri, improper storage, and environmental conditions such as irregular temperature control

either inside or outside the environment, acts of God, fire, flood, delays in transportation, or the failure of Palmieri's suppliers to meet their delivery promises. The acceptance of delivery of the goods by Purchaser shall constitute a waiver of all claims for loss or damage due to any delay whatsoever.

13. RETURNED GOODS

No goods may be returned to Palmieri for a credit or exchanged without Palmieri's prior written consent.

Palmieri reserves the right to accept all returns and subject to a handling/restocking charge or to decline all returns. Even after Palmieri has authorized the return of goods for credit, Palmieri reserves the right to adjust the amount of any credit given to Purchaser on return of the goods based on the conditions of the goods on arrival in Palmieri's warehouse. Credit for returned goods will be issued to Purchaser only where such goods are returned by Purchaser and not by any subsequent owner of the goods. Goods will be considered for return only if they are in their original condition and packaging. Palmieri Goods Return Authorization Form to be issued and **must** accompany all shipments returning back to the factory. **Return freight must be prepaid by Purchaser. A minimum 20% re-stocking fee will apply.**

1230 Reid Street
Richmond Hill
Ontario Canada
L4B 1C4

T 905 731 9300
F 905 731 9878
TF 800 413 4440

info@palmierifurniture.com
www.PalmieriFurniture.com

SPECIFICATION GUIDE & PRICE LIST

2017

PALMIERI

PALMIERI EUROFORM[®]

CATEGORY: LIBRARY FURNITURE
CONTRACT: BID #ESCNJ 17/18-16

Introduction	1
Table of Contents	2-3
Product Materials & Finishes	4-7

Addison	8-11
----------------	-------------

 Display Shelves, Display Box	8-9
---	-----

 Display Cupboard, Display Divider	10-11
--	-------

Alden	12-13
--------------	--------------

 Display	12-13
---	-------

Aurora	14-17
---------------	--------------

 Tables	14-15
---	-------

 Workstations	16-17
---	-------

Benson	18-19
---------------	--------------

 Benson Display	20-21
---	-------

Burke & Celoron	20-21
----------------------------	--------------

 Burke Display	20-21
--	-------

 Celoron Display	20-21
--	-------

Flex	22-29
-------------	--------------

 Tables	22-25
--	-------

 Computer Stations	26-29
---	-------

Harris	30-31
---------------	--------------

 Shelves	30-31
---	-------

Pace	32-33
-------------	--------------

 Ottoman	32-33
---	-------

Shore & Tivoli	34-35
---------------------------	--------------

 Shore Display	34-35
---	-------

 Tivoli Display	34-35
--	-------

Welsley	36-37
----------------	--------------

 Welsley Display	36-37
---	-------

Terminal	38-49
-----------------	--------------

 Terminal Stations	38-47
---	-------

 Mounting Plate	48-49
--	-------

Warranty	50
-----------------	-----------

Terms & Conditions	51
-------------------------------	-----------

WOODS & FINISHES:

Natural Maple Standard

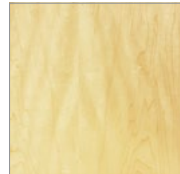

Natural Clear – M-NA

Maple Finishes

The following stains are available, add 10% to list

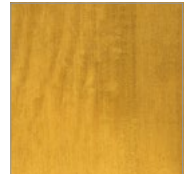

Castle Oak – M-CO



Honey Oak – M-HO

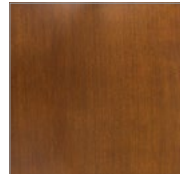

English Oak – M-EN

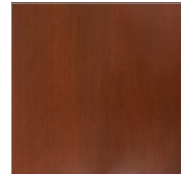

Victorian Cherry – M-VI

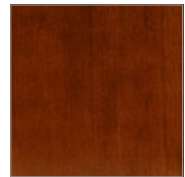

Richmond Cherry – M-RC

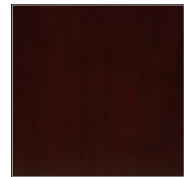

Mahogany – M-MA



Java – M-JA



Wenge – M-WE

Natural Red Oak Standard

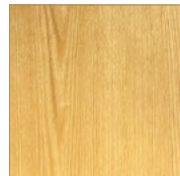

Natural Clear – O-NA

Red Oak Finishes

The following stains are available, add 10% to list

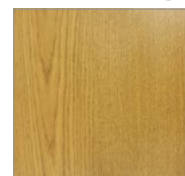

Castle Oak – O-CO

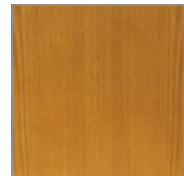

Honey Oak – O-HO

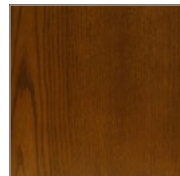

English Oak – O-EN



Victorian Cherry – O-VI

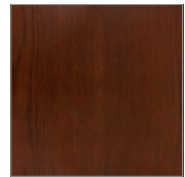

Richmond Cherry – O-RC



Mahogany – O-MA



Java – O-JA



Wenge – O-WE

Natural Cherry

Add 20% to list

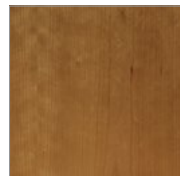

Natural Clear – C-NA

Cherry Finishes

The following stains are available, add 30% to list



Honey Oak – C-HO



Richmond Cherry – C-RC

Natural Walnut

Add 20% to list

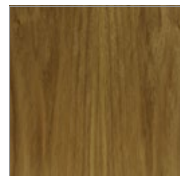

Natural Clear – W-NA

Walnut Finishes

The following stain is available, add 30% to list



Java – W-JA

WILSONART® LAMINATES:

Solid, Abstract and Wood Grain Options

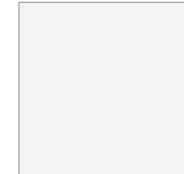

Frosty White
1573-60



Black
1595-60



Island
D498-60

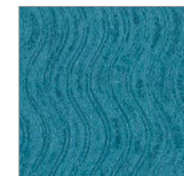

Blue Agave
4919-60

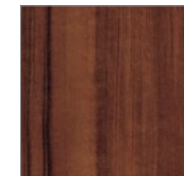

Mambo
7948-60



Grey Elm
8201-38

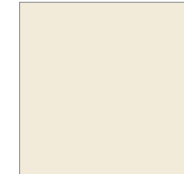

Natural Almond
D30-60



Indigo
D379-60



Hunter Green
D79-60



Eggplant
4913-60

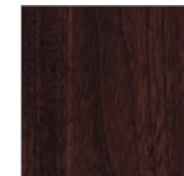

Cocobala
7942-38

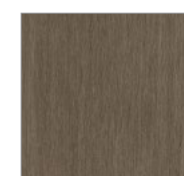

Phantom Cocoa
8213-38



Beige
1530-60

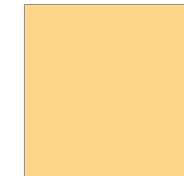

Sunshine
D499-60



Ocean
D502-60

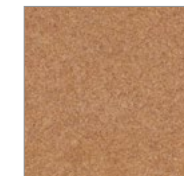

Spiced Zephyr
4859-60

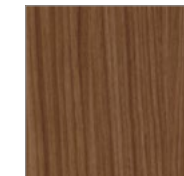

Walnut Heights
7965-38

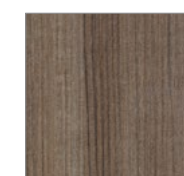

Studio Teak
7960-38



Fashion Grey
D381-60



Orange Grove
D501-60



Lapis Blue
D417-60



Morro Zephyr
4846-60

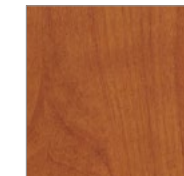

Wild Cherry
7054-60



Skyline Walnut
7964-38



Dove Grey
D92-60



Hollyberry
D307-60



Maroochy Brush
4745-60

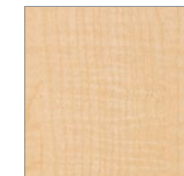

Fusion Maple
7909-60



Phantom Pearl
8211-38



Phantom Charcoal
8214-38



Slate Grey
D91-60



Port
D14-60



Woolamai Brush
4746-60

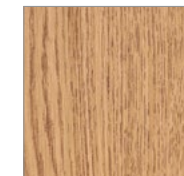

Bannister Oak
7806-60



White Driftwood
8200-38



Asian Night
7949-38

METAL PAINT:

Thermal Paint Colours



White
PS-111-W374



Antique White
W11



Beige
H23

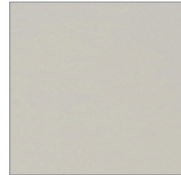

Desert
H432



Red
R66



Ruby
R7



Blue
B11



Navy
B17



Zinc
A67

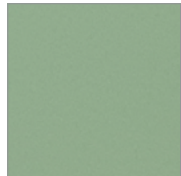

Hydro Green
G96



Green
G58

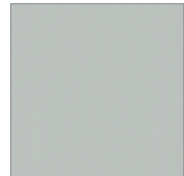

Grey
A16

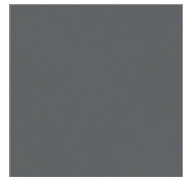

Charcoal
A230



Black
N49



Pebble
M237

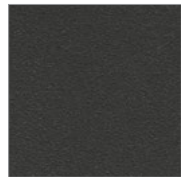

Black Sandtex
N31



Sparkling Silver
S11



Champagne
S14

HARDWOODS: All hardwood materials used in the manufacturing of Palmieri products shall be Northern grown hardwoods. Hardwoods will be air and kiln dried to a moisture content of 5-7%. All hardwoods shall be of grade "A" material, free of material stains, imperfections, conformity of grain, texture and color. Hardwood species shall be Northern grown Red Oak, Clear White Northern Maple and Birch. American Cherry and Honduras Mahogany and Walnut are available. Please inquire for pricing.

VENEER: Exposed face veneers shall be not less than 1/28" thick plain sliced veneers. Veneers are to be selected for conformity of grain direction and color. Veneers are to be stitched tightly in a book match, slip match or plain sliced configuration. Unexposed veneers are to be of hardwood but not selected for color, or grain quality. Veneers are not to be lap joined or reveal any tape or glue lines.

PARTICLE BOARD CORE: The particleboard shall be formed of wood chips, bonded with a water resistance adhesive. The particleboard material is to be of a high density 45 lbs/cu. ft. having a minimum average modulus of rupture of 2400 psi and a minimum average modulus of elasticity of 4,000,000 psi.

VENEER CORE: Veneer core is to be constructed with odd numbers of plies. Each ply is to be laminated in pairs and cross banded in opposite directions with grain direction at a 90 degree angle to the grain of the center core. All plies are to be free from knots, wrinkles, laps or other natural or manufacturing defects.



LUMBER CORE: Lumber core is to be of the highest quality grade. Grade "A" select stock. Lumber core shall be constructed of solid random width strips not less than 2" wide nor more than 3 1/2" wide by 1" thick. Wood strips will be free from knots or other defects. All strips will be tightly joined using water resistance adhesives.

HIGH PRESSURE LAMINATE: Work surface laminate shall be .050" thick and used with balancing backer sheet of no less than .028" thick. Laminate shall conform to standards set by the National Electrical Manufacturers' Association (NEMA).

FINISHING PROCEDURES: All materials shall be inspected and treated with a final sanding and polishing operation before any staining and final finishing can be performed. All machine and mill marks are to be removed. Once the polishing and sanding has been performed, the furniture will then undergo the following stain and finishing procedures:

- Step 1 A base stain will be uniformly applied, wiped and then allowed to dry under factory controlled conditions.
- Step 2 A uniform coat of sealer will be applied and allowed to dry.
- Step 3 Sealer will be lightly sanded using 240 grit silicon paper.
- Step 4 A catalytic lacquer of 34-45 degree sheen is evenly applied and allowed to dry under factory controlled conditions.

METAL FINISHING PROCEDURES: All metal components are thoroughly cleaned and coated electrostatically with an epoxy powder coat paint finish. The metal components are then oven baked and cured for a lasting finish.

	MODEL NUMBER	PRODUCT	WIDTH	DEPTH	HEIGHT	SHELF DEPTH	# OF SHELVES	# OF OPENINGS	WEIGHT	VOLUME	LIST PRICE	DESCRIPTION	
 <p>Model Shown AD-DPS-60-SS</p>	Display Shelves												
	AD-DPS-48-SS	Single Face Starter	37 1/4"	11 1/2"	48"	11 1/2"	3	3			\$ 1,481	Metal Frame: 1" x 2" powder coat paint. Fixed Wood Shelves: 11 1/2" deep x 35" wide, fixed 13" space apart. Decorative Side Screen: 1/2" Frosted acrylic.	
	AD-DPS-48-SA	Single Face Adder	36"	11 1/2"	48"	11 1/2"	3	3			\$ 1,188		
	AD-DPS-60-SS	Single Face Starter	37 1/4"	11 1/2"	60"	11 1/2"	4	4			\$ 1,706		
	AD-DPS-60-SA	Single Face Adder	36"	11 1/2"	60"	11 1/2"	4	4			\$ 1,388		
	AD-DPS-72-SS	Single Face Starter	37 1/4"	11 1/2"	72"	11 1/2"	5	5			\$ 2,131		
	AD-DPS-72-SA	Single Face Adder	36"	11 1/2"	72"	11 1/2"	5	5			\$ 1,619		
	AD-DPS-84-SS	Single Face Starter	37 1/4"	11 1/2"	84"	11 1/2"	6	6			\$ 2,350		
	AD-DPS-84-SA	Single Face Adder	36"	11 1/2"	84"	11 1/2"	6	6			\$ 1,813		
	 <p>Model Shown AD-DPS-60-SA</p>	Display Box											
AD-DPB-48-SS		Single Face Starter	37 1/4"	11 1/2"	48"	11 1/2"	1	4			\$ 2,056		Metal Frame: 1" x 2" powder coat paint. Fixed Wood Shelf: 11 1/2" deep x 35" wide. Decorative Side Screen: 1/2" Frosted acrylic. Shelf Box: 11 1/2" deep x 35 1/4" width x 26" height. Shelf box has one adjustable shelf.
AD-DPB-48-SA		Single Face Adder	36"	11 1/2"	48"	11 1/2"	1	4			\$ 1,863		
AD-DPB-60-SS		Single Face Starter	37 1/4"	11 1/2"	60"	11 1/2"	1	4			\$ 2,219		
AD-DPB-60-SA		Single Face Adder	36"	11 1/2"	60"	11 1/2"	1	4			\$ 2,013		
AD-DPB-72-SS		Single Face Starter	37 1/4"	11 1/2"	72"	11 1/2"	2	5			\$ 2,394		
AD-DPB-72-SA		Single Face Adder	36"	11 1/2"	72"	11 1/2"	2	5			\$ 2,169		
AD-DPB-84-SS		Single Face Starter	37 1/4"	11 1/2"	84"	11 1/2"	3	6			\$ 2,581		
AD-DPB-84-SA		Single Face Adder	36"	11 1/2"	84"	11 1/2"	3	6			\$ 2,338		
 <p>Model Shown AD-DPB-60-SA</p>													

MODEL NUMBER	PRODUCT	WIDTH	DEPTH	HEIGHT	SHELF DEPTH	# OF SHELVES	# OF OPENINGS	WEIGHT	VOLUME	LIST PRICE	DESCRIPTION
Display Cupboard											
AD-DPC-48-SS	Single Face Starter	37 1/4"	11 1/2"	48"	11 1/2"	1	4			\$ 2,606	Metal Frame: 1" x 2" powder coat paint.
AD-DPC-48-SA	Single Face Adder	36"	11 1/2"	48"	11 1/2"	1	4			\$ 2,419	Fixed Wood Shelf: 11 1/2" deep x 35" wide.
AD-DPC-60-SS	Single Face Starter	37 1/4"	11 1/2"	60"	11 1/2"	1	4			\$ 2,813	Decorative Side Screen: 1/2" Frosted acrylic.
AD-DPC-60-SA	Single Face Adder	36"	11 1/2"	60"	11 1/2"	1	4			\$ 2,606	Cupboard: 11 1/2" deep x 35 1/4" wide x 26" high. Cupboard has one adjustable shelf.
AD-DPC-72-SS	Single Face Starter	37 1/4"	11 1/2"	72"	11 1/2"	2	5			\$ 3,031	
AD-DPC-72-SA	Single Face Adder	36"	11 1/2"	72"	11 1/2"	2	5			\$ 2,813	
AD-DPC-84-SS	Single Face Starter	37 1/4"	11 1/2"	84"	11 1/2"	3	6			\$ 3,275	
AD-DPC-84-SA	Single Face Adder	36"	11 1/2"	84"	11 1/2"	3	6			\$ 3,031	
Display Divider											
AD-DPD-48-SS	Single Face Starter	37 1/4"	11 1/2"	48"	11 1/2"	1	4			\$ 2,431	Metal Frame: 1" x 2" powder coat paint.
AD-DPD-48-SA	Single Face Adder	36"	11 1/2"	48"	11 1/2"	1	4			\$ 2,238	Fixed Wood Shelf: 11 1/2" deep x 35" wide.
AD-DPD-60-SS	Single Face Starter	37 1/4"	11 1/2"	60"	11 1/2"	1	4			\$ 2,619	Decorative Side Screen: 1/2" Frosted acrylic.
AD-DPD-60-SA	Single Face Adder	36"	11 1/2"	60"	11 1/2"	1	4			\$ 2,419	Divider Box: 11 1/2" deep x 35 1/4" wide x 26" high. Divider box has 6 slots 5" wide x 11.75" high.
AD-DPD-72-SS	Single Face Starter	37 1/4"	11 1/2"	72"	11 1/2"	2	5			\$ 2,831	
AD-DPD-72-SA	Single Face Adder	36"	11 1/2"	72"	11 1/2"	2	5			\$ 2,606	
AD-DPD-84-SS	Single Face Starter	37 1/4"	11 1/2"	84"	11 1/2"	3	6			\$ 3,050	
AD-DPD-84-SA	Single Face Adder	36"	11 1/2"	84"	11 1/2"	3	6			\$ 2,813	



Model Shown
AD-DPC-60-SS



Model Shown
AD-DPC-60-SA





Model Shown
AD-DPD-60-SS



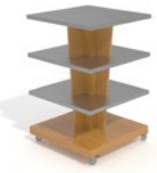





Model Shown
AD-DPD-60-SA



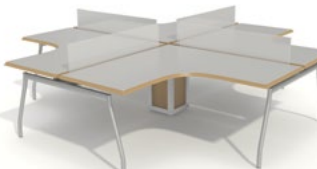





MODEL NUMBER	PRODUCT	WIDTH	DEPTH	HEIGHT	WEIGHT	VOLUME	LIST PRICE	DESCRIPTION
AL-DP-36-W	Wood Display	30"	30"	36"			\$ 2,531	36" High unit is a 3 Tier Platform.
AL-DP-36-L	Laminate Display	30"	30"	36"			\$ 2,094	45" High unit is a 4 Tier Platform.
AL-DP-45-W	Wood Display	30"	30"	45"			\$ 2,888	12" space between shelves. 12" shelf depth.
AL-DP-45-L	Laminate Display	30"	30"	45"			\$ 2,238	Locking casters.





	MODEL NUMBER	PRODUCT	WIDTH	DEPTH	HEIGHT	WEIGHT	VOLUME	LIST PRICE	DESCRIPTION
	AU-3036-SQ	Rectangular Tables	36"	30"	29"			\$ 1,869	Table Top: High pressure laminate surface, 1 1/8" particleboard construction. Wood edge: 3/4" wide external, square profile. Leg: 1 1/2" diameter angle metal, powder coat paint
	AU-3060-SQ		60"	30"	29"			\$ 2,050	
	AU-3072-SQ		72"	30"	29"			\$ 2,144	
	AU-3090-SQ		90"	30"	29"			\$ 2,469	
	AU-3660-SQ		60"	36"	29"			\$ 2,125	
	AU-3672-SQ		72"	36"	29"			\$ 2,225	
	AU-3690-SQ		90"	36"	29"			\$ 2,563	
	AU-4860-SQ		60"	48"	29"			\$ 2,256	
	AU-4872-SQ		72"	48"	29"			\$ 2,375	
	AU-4890-SQ		90"	48"	29"			\$ 2,738	
	AU-3636-SQ	Square Tables	36"	36"	29"			\$ 1,925	
	AU-4242-SQ		42"	42"	29"			\$ 2,025	
	AU-4848-SQ		48"	48"	29"			\$ 2,113	
	AU-R42-SQ	Round Tables	42"	42"	29"			\$ 1,969	
	AU-R48-SQ		48"	48"	29"			\$ 2,056	
	AU-R60-SQ		60"	60"	29"			\$ 2,706	







	MODEL NUMBER	PRODUCT	WIDTH	LENGTH	DEPTH	HEIGHT	WEIGHT	VOLUME	LIST PRICE	DESCRIPTION
	AU-WS2-SQ	Double Workstation	58"	118"	27"	29"			\$ 6,388	<p>Table top: High pressure laminate surface, 1 1/8" particleboard construction.</p> <p>Wood edge: 3/4" wide external, square profile.</p> <p>Leg: 1 1/2" diameter angle metal, powder coat paint.</p> <p>Divider screen: 1/4" x 9" high frosted acrylic. Vertical wire chase 1" x 1" metal frame with removable wood panels.</p>
	AU-WS3-SQ	Triple Workstation	112"	130"	27"	29"			\$ 9,156	
	AU-WS4-SQ	Quad Workstation	118"	118"	27"	29"			\$ 9,775	







	MODEL NUMBER	PRODUCT	WIDTH	DEPTH	HEIGHT	WEIGHT	VOLUME	LIST PRICE	DESCRIPTION
	BE-DP-V1	Display Unit Version 1	32"	24"	66"			\$ 2,694	<p>4 Double faced adjustable shelves: 11 1/2" deep x 20 1/2" wide.</p> <p>4 Side end adjustable shelves: 9 3/4" deep x 10 3/4" wide.</p> <p>Metal Base: Diameter trumpet base, chrome.</p>
	BE-DP-V2	Display Unit Version 2	30"	12 1/2"	66"			\$ 3,294	<p>3 wood adjustable shelves: 11 1/2" deep x 24" wide.</p> <p>Metal Base: Diameter trumpet base, chrome.</p>
	BE-DP-V3	Display Unit Version 3	26"	23"	67"			\$ 3,981	<p>6 wood double sided slant periodical shelves: 23 1/4" wide x 12" high.</p> <p>Decorative side screen: 1/4" frosted acrylic.</p> <p>Metal Base: Diameter trumpet base, chrome.</p>

	MODEL NUMBER	PRODUCT	WIDTH	DEPTH	HEIGHT	WEIGHT	VOLUME	LIST PRICE	DESCRIPTION
	BU-DP	Burke Display Unit	47"	26"	54"			\$ 4,444	<p>3 Media towers: 10³/₄" deep x 10³/₄" wide x 28¹/₂" high.</p> <p>36 total compartments: 5" deep x 5" wide x 8³/₄" high.</p> <p>Metal base: 1¹/₂" x 1¹/₂" powder coat paint.</p>
	CE-DP-42	Celoron Display Unit	33"	26"	42"			\$ 2,044	<p>Wood fixed slant periodical shelves: 23¹/₄" wide x 12" high.</p> <p>42" High Unit has 2 shelves.</p> <p>54" High Unit has 3 shelves.</p> <p>66" High Unit has 4 shelves.</p> <p>78" High Unit has 5 shelves.</p> <p>Metal frame: 1¹/₂" x 1¹/₂" powder coat paint.</p>
	CE-DP-54		33"	26"	54"			\$ 2,094	
	CE-DP-66		33"	26"	66"			\$ 2,150	
	CE-DP-78		33"	26"	78"			\$ 2,200	

	MODEL NUMBER	PRODUCT	WIDTH	DEPTH	HEIGHT	WEIGHT	VOLUME	LIST PRICE	DESCRIPTION			
	FX-3036-SQ	Rectangular Tables	36"	30"	29"			\$ 2,113	Table Top: High pressure laminate surface, 1 1/2" plastic laminate construction. Wood Edge: 1/4" wide internal, square profile. Leg Frame: 1/4" thick x 2" wide metal, power coat paint.			
	FX-3060-SQ		60"	30"	29"			\$ 2,344				
	FX-3072-SQ		72"	30"	29"			\$ 2,444				
	FX-3090-SQ		90"	30"	29"			\$ 2,606				
	FX-3660-SQ		60"	36"	29"			\$ 2,425				
	FX-3672-SQ		72"	36"	29"			\$ 2,531				
	FX-3690-SQ		90"	36"	29"			\$ 2,706				
	FX-4860-SQ		60"	48"	29"			\$ 2,575				
	FX-4872-SQ		72"	48"	29"			\$ 2,706				
	FX-4890-SQ		90"	48"	29"			\$ 2,906				
	FX-3636-SQ	Square Tables	36"	36"	29"			\$ 2,163				
	FX-4242-SQ		42"	42"	29"			\$ 2,219				
	FX-4848-SQ		48"	48"	29"			\$ 2,406				
	FX-3036-SQ-PB-A	Rectangular Tables with Acrylic Panels	36"	30"	29"			\$ 2,575	Table Top: High pressure laminate surface, 1 1/2" plastic laminate construction. Wood Edge: 1/4" wide internal, square profile. Leg Frame: 1/4" thick x 2" wide metal, power coat paint. Panel insert: 1/2" thick Frosted Acrylic.			
	FX-3060-SQ-PB-A		60"	30"	29"			\$ 2,806				
	FX-3072-SQ-PB-A		72"	30"	29"			\$ 2,906				
	FX-3090-SQ-PB-A		90"	30"	29"			\$ 3,069				
	FX-3660-SQ-PB-A		60"	36"	29"			\$ 2,963				
	FX-3672-SQ-PB-A		72"	36"	29"			\$ 3,069				
	FX-3690-SQ-PB-A		90"	36"	29"			\$ 3,244				
	FX-4860-SQ-PB-A		60"	48"	29"			\$ 3,275				
	FX-4872-SQ-PB-A		72"	48"	29"			\$ 3,400				
	FX-4890-SQ-PB-A		90"	48"	29"			\$ 3,600				
			FX-3636-SQ-PB-A	Square Tables with Acrylic Panels	36"	36"	29"				\$ 2,700	
			FX-4242-SQ-PB-A		42"	42"	29"				\$ 2,813	
FX-4848-SQ-PB-A		48"	48"		29"			\$ 3,100				

	MODEL NUMBER	PRODUCT	WIDTH	DEPTH	HEIGHT	WEIGHT	VOLUME	LIST PRICE	DESCRIPTION
	FX-3036-SQ-PB-L	Rectangular Tables with Laminate Panels	36"	30"	29"			\$ 2,375	Table Top: High pressure laminate surface, 1 1/2" plastic laminate construction. Wood Edge: 1/4" wide internal, square profile. Leg Frame: 1/4" thick x 2" wide metal, power coat paint. Panel insert: 3/4" thick with plastic laminate faces and edges.
	FX-3060-SQ-PB-L		60"	30"	29"			\$ 2,606	
	FX-3072-SQ-PB-L		72"	30"	29"			\$ 2,706	
	FX-3090-SQ-PB-L		90"	30"	29"			\$ 2,869	
	FX-3660-SQ-PB-L	Rectangular Tables with Laminate Panels	60"	36"	29"			\$ 2,719	
	FX-3672-SQ-PB-L		72"	36"	29"			\$ 2,825	
	FX-3690-SQ-PB-L		90"	36"	29"			\$ 3,000	
	FX-4860-SQ-PB-L	Rectangular Tables with Laminate Panels	60"	48"	29"			\$ 2,944	
	FX-4872-SQ-PB-L		72"	48"	29"			\$ 3,069	
	FX-4890-SQ-PB-L		90"	48"	29"			\$ 3,275	
		FX-3636-SQ-PB-L	Square Tables with Laminate Panels	36"	36"	29"			\$ 2,456
		FX-4242-SQ-PB-L		42"	42"	29"			\$ 2,538
FX-4848-SQ-PB-L		48"		48"	29"			\$ 2,769	
	FX-3036-SQ-PB-W	Rectangular Tables with Wood Panels	36"	30"	29"			\$ 2,288	Table Top: High pressure laminate surface, 1 1/2" plastic laminate construction. Wood Edge: 1/4" wide internal, square profile. Leg Frame: 1/4" thick x 2" wide metal, power coat paint. Panel insert: 3/4" thick with wood veneer faces and 1/8" wood edges.
	FX-3060-SQ-PB-W		60"	30"	29"			\$ 2,519	
	FX-3072-SQ-PB-W		72"	30"	29"			\$ 2,619	
	FX-3090-SQ-PB-W		90"	30"	29"			\$ 2,781	
	FX-3660-SQ-PB-W	Rectangular Tables with Wood Panels	60"	36"	29"			\$ 2,606	
	FX-3672-SQ-PB-W		72"	36"	29"			\$ 2,719	
	FX-3690-SQ-PB-W		90"	36"	29"			\$ 2,894	
	FX-4860-SQ-PB-W	Rectangular Tables with Wood Panels	60"	48"	29"			\$ 2,788	
	FX-4872-SQ-PB-W		72"	48"	29"			\$ 2,919	
	FX-4890-SQ-PB-W		90"	48"	29"			\$ 3,119	
		FX-3636-SQ-PB-W	Square Tables with Wood Panels	36"	36"	29"			\$ 2,344
		FX-4242-SQ-PB-W		42"	42"	29"			\$ 2,419
FX-4848-SQ-PB-W		48"		48"	29"			\$ 2,619	

	MODEL NUMBER	PRODUCT	WIDTH	DEPTH	HEIGHT	WEIGHT	VOLUME	LIST PRICE	DESCRIPTION
	FX-CS2-SQ	2 Person Computer Station	36"	60"	29"			\$ 3,350	<p>Table Top: High pressure laminate surface, 1 1/2" plastic laminate construction.</p> <p>Wood Edge: 1/4" wide internal, square profile.</p> <p>Leg Frame: 1/4" thick x 2" wide metal, power coat paint.</p> <p>Design feature: separated double top.</p> <p>Divider screen: 9" high frosted acrylic.</p>
	FX-CS4-SQ	4 Person Computer Station	72"	60"	29"			\$ 4,150	
	FX-CS6-SQ	6 Person Computer Station	96"	60"	29"			\$ 4,650	
	FX-CS2-SQ-PB-A	2 Person Computer Station with Acrylic Panels	36"	60"	29"			\$ 5,288	<p>Table Top: High pressure laminate surface, 1 1/2" plastic laminate construction.</p> <p>Wood Edge: 1/4" wide internal, square profile.</p> <p>Leg Frame: 1/4" thick x 2" wide metal, power coat paint.</p> <p>Panel insert: 1/2" thick Frosted Acrylic.</p> <p>Design feature: separated double top.</p> <p>Divider screen: 9" high frosted acrylic.</p>
	FX-CS4-SQ-PB-A	4 Person Computer Station with Acrylic Panels	72"	60"	29"			\$ 6,081	
	FX-CS6-SQ-PB-A	6 Person Computer Station with Acrylic Panels	96"	60"	29"			\$ 6,588	

	MODEL NUMBER	PRODUCT	WIDTH	DEPTH	HEIGHT	WEIGHT	VOLUME	LIST PRICE	DESCRIPTION
	FX-CS2-SQ-PB-L	2 Person Computer Station with Laminate Panels	36"	60"	29"			\$ 3,931	<p>Table Top: High pressure laminate surface, 1 1/2" plastic laminate construction.</p> <p>Wood Edge: 1/4" wide internal, square profile.</p> <p>Leg Frame: 1/4" thick x 2" wide metal, power coat paint.</p>
	FX-CS4-SQ-PB-L	4 Person Computer Station with Laminate Panels	72"	60"	29"			\$ 4,731	<p>Panel insert: 3/4" thick with plastic laminate faces and edges.</p> <p>Design feature: separated double top.</p> <p>Divider screen: 9" high frosted acrylic.</p>
	FX-CS6-SQ-PB-L	6 Person Computer Station with Laminate Panels	96"	60"	29"			\$ 5,231	
	FX-CS2-SQ-PB-W	2 Person Computer Station with Wood Panels	36"	60"	29"			\$ 3,856	<p>Table Top: High pressure laminate surface, 1 1/2" plastic laminate construction.</p> <p>Wood Edge: 1/4" wide internal, square profile.</p> <p>Leg Frame: 1/4" thick x 2" wide metal, power coat paint.</p>
	FX-CS4-SQ-PB-W	4 Person Computer Station with Wood Panels	72"	60"	29"			\$ 4,650	<p>Panel insert: 3/4" thick with wood veneer faces and 1/8" wood edges.</p> <p>Design feature: separated double top.</p> <p>Divider screen: 9" high frosted acrylic.</p>
	FX-CS6-SQ-PB-W	6 Person Computer Station with Wood Panels	96"	60"	29"			\$ 5,156	



Model Shown
AD-DPC-60-SS



Model Shown
AD-DPC-60-SA





Model Shown
AD-DPD-60-SS





Model Shown
AD-DPD-60-SA

MODEL NUMBER	PRODUCT	WIDTH	DEPTH	HEIGHT	SHELF DEPTH	# OF SHELVES	# OF OPENINGS	WEIGHT	VOLUME	LIST PRICE	DESCRIPTION	
	Flat Shelves, Original Box Base											
HA-DP-1A-52-W	Wood	40"	23"	52"	19"	1	2			\$ 2,513	All shelves are 37 1/2" wide and are fixed spaced 13" apart. Metal frame: 1" x 2", powder coat paint. Closed wood base: 23" deep x 40" wide x 24" high.	
HA-DP-1A-52-L	Laminate	40"	23"	52"	19"	1	2			\$ 2,306		
HA-DP-1A-66-W	Wood	40"	23"	66"	19"	2	3			\$ 2,719		
HA-DP-1A-66-L	Laminate	40"	23"	66"	19"	2	3			\$ 2,519		
HA-DP-1A-78-W	Wood	40"	23"	78"	19"	3	4			\$ 2,938		
HA-DP-1A-78-L	Laminate	40"	23"	78"	19"	3	4			\$ 2,731		
	Flat Shelves, 2 Drawer Base											
HA-DP-1B-52-W	Wood	40"	23"	52"	19"	1	2			\$ 2,656		All shelves are 37 1/2" wide and are fixed spaced 13" apart. Metal frame: 1" x 2", powder coat paint. Wood base: 23" deep x 40" wide x 24" high. 2 Drawers: 18" deep x 37 1/2" wide x 7 1/2" high.
HA-DP-1B-52-L	Laminate	40"	23"	52"	19"	1	2			\$ 2,456		
HA-DP-1B-66-W	Wood	40"	23"	66"	19"	2	3			\$ 2,869		
HA-DP-1B-66-L	Laminate	40"	23"	66"	19"	2	3			\$ 2,663		
HA-DP-1B-78-W	Wood	40"	23"	78"	19"	3	4			\$ 3,081		
HA-DP-1B-78-L	Laminate	40"	23"	78"	19"	3	4			\$ 2,875		
	Flat Shelves, 2 Cubie Doors Base											
HA-DP-1C-52-W	Wood	40"	23"	52"	19"	1	2			\$ 2,600	All shelves are 37 1/2" wide and are fixed spaced 13" apart. Metal frame: 1" x 2", powder coat paint. Wood base: 23" deep x 40" wide x 24" high, with cupboard doors and one adjustable shelf.	
HA-DP-1C-52-L	Laminate	40"	23"	52"	19"	1	2			\$ 2,444		
HA-DP-1C-66-W	Wood	40"	23"	66"	19"	2	3			\$ 2,813		
HA-DP-1C-66-L	Laminate	40"	23"	66"	19"	2	3			\$ 2,650		
HA-DP-1C-78-W	Wood	40"	23"	78"	19"	3	4			\$ 3,025		
HA-DP-1C-78-L	Laminate	40"	23"	78"	19"	3	4			\$ 2,863		
	Flat Shelves, Open Box Base											
HA-DP-1D-52-W	Wood	40"	23"	52"	19"	1	2			\$ 2,519		All shelves are 37 1/2" wide and are fixed spaced 13" apart. Metal frame: 1" x 2", powder coat paint. Wood base: 23" deep x 40" wide x 24" high. Open shelf unit with one adjustable shelf.
HA-DP-1D-52-L	Laminate	40"	23"	52"	19"	1	2			\$ 2,325		
HA-DP-1D-66-W	Wood	40"	23"	66"	19"	2	3			\$ 2,725		
HA-DP-1D-66-L	Laminate	40"	23"	66"	19"	2	3			\$ 2,488		
HA-DP-1D-78-W	Wood	40"	23"	78"	19"	3	4			\$ 2,944		
HA-DP-1D-78-L	Laminate	40"	23"	78"	19"	3	4			\$ 2,738		

	MODEL NUMBER	PRODUCT	WIDTH	DEPTH	HEIGHT	WEIGHT	VOLUME	LIST PRICE	DESCRIPTION
	PA-OMT-90-V1	Mobile Ottoman Triangle Version 1	25 ³ / ₄ "	25 ³ / ₄ "	21"			\$ 2,469	Seat: 6 ¹ / ₄ " foam. Seat Height: 17". Caster: 2 ¹ / ₂ " hidden casters
	PA-OMT-90-V2	Mobile Ottoman Triangle Version 2	24"	24"	17"			\$ 2,406	





MODEL NUMBER	PRODUCT	WIDTH	DEPTH	HEIGHT	WEIGHT	VOLUME	LIST PRICE	DESCRIPTION
SH-DP-48	Shore Display Unit	36"	36"	48"			\$ 2,844	<p>Contains metal slant periodical shelves, each 24" wide x 12" high.</p> <p>48" high unit consists of 9 shelves. 60" high unit consists of 12 shelves. 72" high unit consists of 15 shelves.</p> <p>Metal triangle frame is 1 1/2" x 1 1/2" powder coat paint.</p> <p>Wood base and top is 36" diameter, plywood construction.</p>
SH-DP-60		36"	36"	60"			\$ 3,481	
SH-DP-72		36"	36"	72"			\$ 3,756	
TV-DP-48	Tivoli Display Unit	31"	31"	48"			\$ 3,688	<p>48" high unit consists of 2 tier with 4 shelves. 60" high unit consists of 3 tier with 8 shelves. 72" high unit consists of 4 tier with 12 shelves.</p> <p>Unit has a 360 degree swivel.</p> <p>Each compartment in the unit is 11" deep x 18" wide.</p> <p>Decorative side screen is 1/2" frosted acrylic.</p> <p>Wood base is 14" high.</p>
TV-DP-60		31"	31"	60"			\$ 4,025	
TV-DP-72		31"	31"	72"			\$ 4,388	

	MODEL NUMBER	PRODUCT	WIDTH	DEPTH	HEIGHT	WEIGHT	VOLUME	LIST PRICE	DESCRIPTION
	WE-DP-1A	Closed Base	50"	32"	45 1/2"			\$ 2,575	<p>Unit consists of a 3 tier platform, each spaced 12" apart from the other.</p> <p>Top Platform: 8 3/4" deep x 12" wide Middle Platform: 19 1/4" deep x 30" wide Bottom Platform: 31 3/4" deep x 50" wide</p> <p>Metal frame: 1 1/2" x 1 1/2", powder coat paint.</p> <p>Closed Wood Base: 30" deep x 49 1/2" wide x 14 1/2" high with mobile casters.</p>
	WE-DP-1D	Open Box Base	50"	32"	45 1/2"			\$ 2,694	<p>Unit consists of a 3 tier platform, each spaced 12" apart from the other.</p> <p>Top Platform: 8 3/4" deep x 12" wide Middle Platform: 19 1/4" deep x 30" wide Bottom Platform: 31 3/4" deep x 50" wide</p> <p>Metal frame: 1 1/2" x 1 1/2", powder coat paint.</p> <p>Open Box Wood Base: 14" deep x 49 1/2" wide x 14 1/2" high with mobile casters.</p>

MODEL NUMBER	PRODUCT	WIDTH	DEPTH	HEIGHT	WEIGHT	VOLUME	LIST PRICE	DESCRIPTION
 TM-1-L	Terminal 1 Laminate Top	36"	33 1/2"	60"			\$ 5,819	<p>KEYBOARD SURFACE & MOUSE LEDGE: Tops are constructed of 1" thick 3-ply particleboard core. The tops' surfaces are laminated with a .050" thick high pressure plastic laminate sheet and bottom surface laminated with a backing sheet not less than .020" thick for balanced construction. All edges will be banded with a 1/8" thick acrylic edge and is 37" high from finished floor.</p> <p>CPU CABINET: Constructed from 3/4" high density particleboard core with grade 'A' face veneers. Cabinet consists of a vented locking side door with dimensions 14 1/4" deep x 24" wide x 26" high. The rear of the unit consists of a wood column and a 1/2" thick frosted acrylic arched panel. For custom decorative panel or graphics, please inquire with Palmieri for pricing.</p> <p>TERMINAL BASE: Metal legs are 1 1/2" x 1 1/2" epoxy powder coated.</p> <p>MONITOR CAPABILITY: A wood mounting plate is provided and utilizes monitor arm TM-MA-1, offered separately.</p>

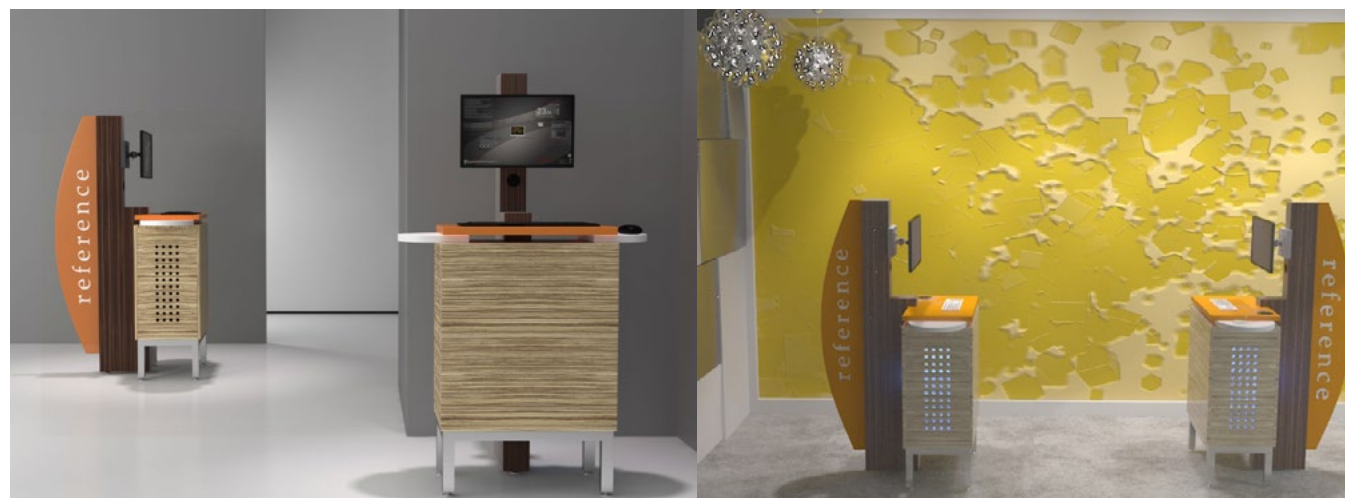
TM-1 Layout Options



MODEL NUMBER	PRODUCT	WIDTH	DEPTH	HEIGHT	WEIGHT	VOLUME	LIST PRICE	DESCRIPTION
 TM-2-L	Terminal 2 Laminate Top	24"	24"	57"			\$ 4,550	<p>KEYBOARD SURFACE & MOUSE LEDGE: Tops are constructed of 1" thick 3-ply particleboard core. The top surface is laminated with a .050" thick high pressure plastic laminate sheet and bottom surface laminated with a backing sheet not less than .020" thick for balanced construction. All edges will be banded with a 1/8" thick acrylic edge and is 37" high from finished floor.</p> <p>CPU CABINET: Constructed from 3/4" high density particleboard core with grade 'A' face veneers. Cabinet consists of a vented locking side door with dimensions 12" deep x 24" wide x 24" high.</p> <p>TERMINAL BASE: Metal structural column is 2" x 2" epoxy powder coated and consists of a 24" deep x 24" wide x 4" high wood angled platform base..</p> <p>MONITOR CAPABILITY: A wood mounting plate is provided and utilizes monitor arm TM-MA-1, offered separately.</p>

TM-2 Usage Option



MODEL NUMBER	PRODUCT	WIDTH	DEPTH	HEIGHT	WEIGHT	VOLUME	LIST PRICE	DESCRIPTION
 TM-3-L	Terminal 3 Laminate Top	24"	28 1/4"	60"			\$ 5,888	<p>KEYBOARD SURFACE & MOUSE LEDGE: Tops are constructed of 1" thick 3-ply particleboard core. The top surface is laminated with a .050" thick high pressure plastic laminate sheet and bottom surface laminated with a backing sheet not less than .020" thick for balanced construction. All edges will be banded with a 1/8" thick acrylic edge and is 37" high from finished floor.</p> <p>CPU CABINET: Constructed from 3/4" high density particleboard core with grade 'A' face veneers. Cabinet consists of a vented locking side door with dimensions 12" deep x 24" wide x 24" high and the rear of the unit consists of a wood column.</p> <p>TERMINAL BASE: Metal structural column is 2 1/2" diameter epoxy powder coated and consists of a 23" deep x 23" wide x 4" high wood platform base.</p> <p>MONITOR CAPABILITY: A wood mounting plate is provided and utilizes monitor arm TM-MA-1, offered separately.</p>

TM-3 Usage Option



MODEL NUMBER	PRODUCT	WIDTH	DEPTH	HEIGHT	WEIGHT	VOLUME	LIST PRICE	DESCRIPTION
TM-4-L	Terminal 4 Laminate Top	24"	23 ³ / ₄ "	48"			\$ 4,863	<p>KEYBOARD SURFACE & MONITOR LEDGE: Tops are constructed of 1" thick 3-ply particleboard core. The tops' surfaces are laminated with a .050" thick high pressure plastic laminate sheet and bottom surface laminated with a backing sheet not less than .020" thick for balanced construction. All edges will be banded with a 1/8" thick acrylic edge. Monitor ledge consists of a 7" high frosted acrylic screen and is 41" high from finished floor. The keyboard surface is 37" high from finished floor.</p> <p>CPU CABINET: Constructed from 3/4" high density particleboard core with grade 'A' face veneers. Cabinet consists of a perforated metal vent locking side door with dimensions 12" deep x 24" wide x 24" high and enveloped with diameter metal tubing.</p> <p>TERMINAL BASE: Metal framing tubing is 1 1/2" diameter epoxy powder coated.</p>



TM-4 Usage Option



MODEL NUMBER	PRODUCT	WIDTH	DEPTH	HEIGHT	WEIGHT	VOLUME	LIST PRICE	DESCRIPTION
 TM-5-L	Terminal 5 Laminate Top	24"	20 ¹ / ₄ "	48"			\$ 4,656	<p>KEYBOARD SURFACE & MONITOR LEDGE: Tops are constructed of 1" thick 3-ply particleboard core. The Tops' surfaces are laminated with a .050" thick high pressure plastic laminate sheet and bottom surface laminated with a backing sheet not less than .020" thick for balanced construction. All edges will be banded with a 1/8" thick acrylic edge. Monitor ledge consists of a 7" high metal surround and is 41" high from finished floor. The keyboard surface is 37" high from finished floor.</p> <p>CPU CABINET: Constructed from 3/4" high density particleboard core with grade 'A' face veneers. Cabinet consists of a perforated metal vent locking side door with dimensions 12" deep x 24" wide x 24" high.</p> <p>TERMINAL BASE: Metal structural column is 1 1/2" x 1 1/2" epoxy powder coated and consists of a 24" deep x 24" wide metal platform base.</p>

TM-5 Usage Option

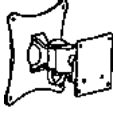

	MODEL NUMBER	PRODUCT	WIDTH	DEPTH	HEIGHT	WEIGHT	VOLUME	LIST PRICE	DESCRIPTION
	TM-MA-1	Short Mounting Plate		4 ³ / ₄ "				\$ 469	<p>COLOR: Black wall and monitor mounting plate with silver arm.</p> <p>CAPABILITY: 360 degree monitor rotation, up and down tilt and holds monitors up to 17 pounds.</p>

Palmieri Furniture Limited ("Palmieri") warrants that its products and collections are free from defects in materials and workmanship for the life of the product, except as set forth below. Palmieri Limited Lifetime Warranty is valid from the date of delivery.

Exceptions to the Limited Lifetime Warranty: Seating: two (2) years

Goods sold hereunder are covered by a Limited Lifetime Warranty, free against defects in material and workmanship provided the goods and services are subjected to normal use and service. The applicable warranty period commences from shipping date to Purchaser of any item of the goods, whichever occurs first, or any other warranty period otherwise stipulated in writing by Palmieri under this sale. For components not supplied by Palmieri, the original manufacturer's warranty shall apply to the extent assignable by Palmieri. The obligation under this warranty is limited to the repair or replacement, at Palmieri's option, of defective parts F.O.B. point of shipment provided that prompt notice of any defect is given by Purchaser to Palmieri in writing within the applicable warranty period and that upon the Purchaser's return of the defective parts to Palmieri or, if designated by Palmieri, to the location where the works are made, properly packed and with transportation charges prepaid by Purchaser, an inspection thereof shall reveal to Palmieri's satisfaction that Purchaser's claim is valid under the terms of this warranty. Purchaser shall assume all responsibility and expense for dismantling, removal, re-installation and freight in connection with the foregoing. The same obligations and conditions extend to replacement parts furnished by Palmieri hereunder.

Palmieri does not assume liability for installation, labour or consequential damages. Palmieri makes no warranty other than the one set forth herein. All other warranties, legal, expressed or implied, including but not limited to any expressed or implied warranty of merchantability, of fitness for the intended use thereof or against infringement are hereby expressly excluded. The applicable warranty ceases to be effective if the goods are altered or repaired other than by persons authorized or approved by Palmieri to perform such work. Repairs or replacement deliveries do not interrupt or prolong the term of the warranty. The warranty ceases to be effective if Purchaser fails to handle and use the goods sold hereunder in a safe and reasonable manner and in accordance with any written instructions from the manufacturers.

Warranty Does Not Apply To Product Failure Or Loss Resulting From:

Abuse, misuse or accident, alteration or modification of product by customer or third party, normal wear and tear, improper installation, handling or incorrect use. The substitution of part components or hardware not approved or authorized by Palmieri, acts of God, unauthorized repairs, improper storage, and environmental conditions such as irregular temperature control either inside or outside the environment.

Warranty Provides Exclusive Remedies:

If a product fails under ordinary use as a result of a defect in material or workmanship, Palmieri will: (A) repair, or (B) replace the furniture. The replacement or repair of the Furniture or Seating will be at the discretion of Palmieri. If the defect or workmanship cannot be remedied on site, repairs can be made at the factory. (C) If the product repair or replacement is not commercially practicable or cannot be remade in a timely manner Palmieri will refund the purchase price of the affected product. A product "**Defect**" means: an inadequacy in the materials or workmanship of the product that (A) existed at the time when you received the product from Palmieri or Palmieri authorized Reseller and (B) causes a failure of the product to perform under ordinary use in accordance with the materials and documentation accompanying the product. "**Ordinary Use**" means: use of the product (A) in accordance with all applicable local, state or federal laws, codes and regulations and (B) in accordance with manufacturer recommendations and or instructions in the materials and documentation accompanying the product or through shop drawings. A "**Palmieri Authorized Reseller**" means: any dealer that is legally permitted to conduct business in the jurisdiction where the product is sold and is duly authorized by Palmieri to sell the product.

Warranty work must be approved by authorized personnel of Palmieri Furniture Limited in Richmond Hill, Ontario, Canada.

A copy of the original purchase order must accompany all claims.

Warranty Does Not Cover:

Matching of colours, stains, textures, grains and any other variations in materials. Select and Custom Surfaces and materials are only warranted for their application on the specified product and are not covered by our warranty, except as warranted by the original supplier, for quality, colorfastness, shade variations or abrasion and textiles purchased for Palmieri product.

This limited warranty is the sole remedy for product defect and no other express or implied warranty is provided. Warranty is not transferable and valid only for the original purchaser acquiring a product from Palmieri or a Palmieri authorized reseller for the purchaser's own use and not for resale, remarketing or distribution. Limited Lifetime Warranty (25 years)

GENERAL

The following Terms and Conditions of Quote and Sale shall apply to any sale of goods and services by Palmieri Furniture Limited (hereinafter called "Palmieri"). Purchaser shall be deemed to have full knowledge of the terms and conditions herein and such terms and conditions shall be binding if either the goods and services referred to herein are delivered to and accepted by Purchaser, or if Purchaser does not within five (5) days from the date hereof deliver to Palmieri written objection to said terms and conditions or any part thereof.

In the event of any conflict or inconsistency between the terms and conditions of sale herein and the terms and conditions contained in Purchaser's order or in any other form issued by Purchaser, whether or not any such form has been acknowledged or accepted by Palmieri, Palmieri's terms and conditions herein shall prevail. No waiver, alteration or modification of these terms and conditions shall be binding upon Palmieri unless made in writing and signed by a duly authorized representative of Palmieri.

1. QUOTATIONS / PRODUCT QUOTED

Unless otherwise stated, **Palmieri's quotations shall be null and void unless accepted by Purchaser within thirty (30) days from the date of quotation.** Quotes may be subject to change before order placement, due to increased material costs and or other factors that could impact the final cost of production and our final understanding of the product required. If the items quoted do not reflect the intended product requirements of the customer, Palmieri will not be held responsible for increased costs for those product changes. We reserve the right to edit or re-quote any portion of a previously submitted quotation subject to our final understanding of the product required by the client.

2. PALMIERI DRAWINGS

Palmieri provides drawings for Custom & Standard product we produce to our clients upon request. We consider these drawings to be Private and Confidential and are provided for the sole purpose and use of our clients to understand the product we are providing. The use of these confidential materials is limited to the transaction between the parties and at no point are these confidential materials to be sent to any of our competitors or parties quoting for the same purpose.

A minimum \$85.00 NET Engineering Administrative Fee will apply for Custom Product Drawings

(Note: The first set of Custom product drawings will be free of charge)

A minimum \$120.00 NET Engineering Administrative Fee will apply for all Standard Product Drawings

3. TERMS OF PAYMENT

For authorized customers; Orders at a \$75,000.00 threshold will require a mandatory 25% deposit. Orders over and above \$100,000.00 requires a mandatory (25%) deposit at time of order, a mandatory (25%) deposit prior to product shipment and the balance to be paid within thirty (30) days of date of shipment. Payment not be made to Palmieri when due, Palmieri reserves the right to charge Purchaser with interest on such overdue payments. Interest of 2% per month (24% per annum) is charged on all overdue accounts, unless otherwise specified. The charging of such interest shall not be construed as obligating Palmieri to grant any extension of time in the terms of payment. All goods remain the property of Palmieri, until balance is paid in full to Palmieri.

4. TITLE

Title to the goods or any part thereof shall not pass from Palmieri to Purchaser until all payments due hereunder have been duly made, except as otherwise expressly stipulated herein. The goods shall be and remain personal or moveable property, notwithstanding their mode of attachment to realty or other property. If default is made in any of the payments herein, Purchaser agrees that Palmieri may retain all payments which have been made on account of the purchase price as liquidated damages, and Palmieri shall be free to enter the premises where the goods may be located and remove them as Palmieri's property, without prejudice to Palmieri's right to recover any further expenses or damages Palmieri may suffer by reason of such nonpayment.

5. TAXES

Prices do not include Goods & Services Tax, Provincial or Municipal sales, use, value-added or similar tax. All applicable taxes are extra. Our Harmonized Sales Tax (HST) registration number is R104055066.

6. THE AGREEMENT

An acceptance and official confirmation of Purchasers' order by signing Palmieri's Order Confirmation the Purchaser therefore is accepting terms and conditions as expressed herein Palmieri's Terms and Conditions of Quote and Sale by Palmieri and shall constitute the complete agreement, subject to the terms and conditions of sale herein set forth, and shall supersede all previous quotations, orders or agreements.

7. LEAD TIME / DELIVERY / DELAYS

Lead time is determined only when final material/finish selection and drawing approvals are received by Palmieri from the client. The accuracy of Palmieri's lead times, is created to the best of our ability with the information provided to us. Confirmed lead time is conveyed to the client by means of Order Confirmation. They do not preclude the client from checking the accuracy of your requirement and our Order Confirmation. Any noted discrepancies are to be reported immediately to Palmieri Customer Service Department for correction and re-issue of revised Order Confirmation. By signing and dating the Order Confirmation the client accepts the terms and conditions of quote and sale.

Lead time on our Order Confirmation do not account for delays that could potentially occur for special materials specified by the client that are outside of our standard finishes and materials program that are out of our control

and will affect the lead time on the order. Palmieri will notify the client immediately when these delays occur and adjust the lead time accordingly.

Delivery schedules are approximate and are based on prevailing market conditions applicable respectively at the time of Palmieri's quotation and Palmieri's acceptance of clients' order, if certain portions of an order are completed by the quoted lead time while other portions have experienced delays outside of our control. The client may choose to part ship the order at their discretion and expense. Otherwise the entire order will ship with the delayed portion at a later date. Palmieri may extend delivery schedules or may, at its option, cancel Purchaser's order in full or in part without liability other than to return any deposit or prepayment which is unearned by reason of the cancellation.

8. CHANGES AND CANCELLATION

Orders accepted by Palmieri are not subject to changes or cancellation by Purchaser without the written consent of Palmieri. In such cases where Palmieri authorizes changes or cancellation, Palmieri reserves the right to charge the Purchaser with reasonable costs based upon expenses already incurred and commitments made by Palmieri, including, without limitation, any labour done, material purchased and also including Supplier's usual overhead and reasonable profit and cancellation charges from Palmieri's suppliers. Palmieri will communicate to the Purchaser additional costs incurred by way of Revised Order Confirmation. Revised Order Confirmation will include applicable costs incurred and modification to lead times (if applicable). The Purchaser must provide Palmieri written confirmation of additional costs, before any changes can be processed on the order.

A minimum charge of \$100.00 NET Change Order Request fee will apply

A minimum charge of \$150.00 NET Cancel Order Request fee will apply.

9. SHIPPING LOCATION / SHIPPING QUOTES / COST OF TRANSPORTATION

Unless otherwise stated, all prices are F.O.B. our factory in Richmond Hill, Ontario, Canada.

Customary methods of transportation shall be selected by Palmieri and such transportation will be at Purchaser's expense. Shipping quotations are made at time of furniture quotation and are outside the control of Palmieri. **Shipping quotes are valid for ten (10) business days from the time of quote.** We do our best to maintain shipping costs as quoted, however all shipping weights and cubic feet shown are approximate only, various construction materials and packaging methods may add to the weights given. All quoted prices, unless otherwise stated on the quotation, are based on the current exchange rates, tariffs, fuel surcharges and costs of manufacture and are subject to change by Palmieri with or without notice until Purchaser's acceptance. Palmieri does not assume responsibility or liability for shipping costs, product during transit, or variances from the shipping weights or cubic feet shown in our specification guides. Special methods of transportation will be used upon Purchaser's request and at Purchaser's additional expense, provided reasonable notice of Purchaser's transportation requirements are given by Purchaser to Palmieri prior to shipment. Palmieri will notify the client prior to shipping product if shipping costs as quoted change, at which point the client must approve the adjusted shipping costs.

10. RECEIVING PRODUCT / REPORTING DAMAGE / STORAGE OF PRODUCT

Upon receipt of Palmieri product, the receiver of the goods must immediately inspect the product to ensure it is free of shipping damage. If the product is deemed in good order, the receiver of the product must ensure

to sign off on the accompanying carriers Bill of lading in good condition. Except for obligations stated under "Warranty" herein, Palmieri's responsibility for the product ceases once the product has been received and signed off in good order and is the full responsibility of the receiver and subsequently the owner.

In the event shipping damage is discovered during receipt of shipment, it is the responsibility of the receiver to ensure all noted damage is recorded on the carrier's Bill of Lading prior to sign off. All noted shipping damage claims must be reported to Palmieri within **24 hours** of receipt of the product onsite, failure to do so will result in the claim being deemed null and void. All shipping damage claims are to be reported directly to Palmieri's Shipping Manager. Please call our toll free number at **1-800-413-4440 ext. 33** or submit the claim by Fax directly to **1-905-731-9878**. Palmieri will not accept any shipping damage claims submitted **after 24 hours** and it shall be conclusively presumed that the goods were delivered in good condition.

Storage of product, Palmieri will not be held responsible for any potential damages or shortages for product shipped and received by Purchaser and is subsequently placed into storage and not inspected within 24 hours of receipt.

11. INSTALLATION / SHORTAGES / BACK CHARGES

Unless otherwise expressly stipulated, the goods shall be installed by and at the risk and expense of Purchaser.

In the event that Palmieri is requested to supervise such installation, Palmieri's responsibility shall be limited to exercising that degree of skill customary in the trade in supervising installations of the same type. Purchaser shall remain responsible for all other aspects of the work including compliance with the local regulations. It is the responsibility of the Purchaser to ensure hardware and parts are received in good order. Packing slip and hardware list to be provided by Palmieri with every order at time of shipping. Purchaser has the responsibility to notify Palmieri immediately without delay of issues that arise; subsequently Palmieri will take action to provide prompt resolution.

Shortages must be reported to Palmieri within **24 hours** of receipt of the goods and failure to do so may be at the expense of the Purchaser.

If deemed missing hardware and parts short shipped from the factory, Palmieri will arrange to ship freight prepaid to destination. Palmieri will only be responsible for replacement costs of missing hardware and parts, any labour costs incurred will be the responsibility of the Purchaser and will not be approved by Palmieri.

Back Charges will only be approved if we deemed a defect in the material or workmanship is found during the installation period resulting in a return trip to the job-site to complete installation. It shall remain the sole discretion of Palmieri to approve (A) repair or (B) replace the furniture and any labour costs incurred by the Purchaser.

12. FORCE MAJEURE

Palmieri shall not be responsible or liable for any loss or damage incurred by Purchaser herein resulting from causes beyond the reasonable control of Palmieri including, but without limitation, abuse, misuse or accident, alteration or modification of product by customer or third party, normal wear and tear, improper installation, handling or incorrect use, unauthorized repairs, the substitution of part components or hardware not approved or authorized by Palmieri, improper storage, and environmental conditions such as irregular temperature control

either inside or outside the environment, acts of God, fire, flood, delays in transportation, or the failure of Palmieri's suppliers to meet their delivery promises. The acceptance of delivery of the goods by Purchaser shall constitute a waiver of all claims for loss or damage due to any delay whatsoever.

13. RETURNED GOODS

No goods may be returned to Palmieri for a credit or exchanged without Palmieri's prior written consent.

Palmieri reserves the right to accept all returns and subject to a handling/restocking charge or to decline all returns. Even after Palmieri has authorized the return of goods for credit, Palmieri reserves the right to adjust the amount of any credit given to Purchaser on return of the goods based on the conditions of the goods on arrival in Palmieri's warehouse. Credit for returned goods will be issued to Purchaser only where such goods are returned by Purchaser and not by any subsequent owner of the goods. Goods will be considered for return only if they are in their original condition and packaging. Palmieri Goods Return Authorization Form to be issued and **must** accompany all shipments returning back to the factory. **Return freight must be prepaid by Purchaser. A minimum 20% re-stocking fee will apply.**

1230 Reid Street
Richmond Hill
Ontario Canada
L4B 1C4

T 905 731 9300
F 905 731 9878
TF 800 413 4440

info@palmierifurniture.com
www.PalmieriFurniture.com

SPECIFICATION GUIDE & PRICE LIST

2017

PALMIERI

END PANELS & TOPS

CATEGORY: LIBRARY FURNITURE
CONTRACT: BID #ESCNJ 17/18-16

Table of Contents	2-3
-------------------	-----

Product Materials & Finishes	4-5
------------------------------	-----

Canopy Tops:	6-15
---------------------	-------------



Bannister



Beta



Delicato



Element



Ronda

End Panels:	16-41
--------------------	--------------

 Aspen	16-17
--	-------

 Aspen II	18-19
---	-------

 Bannister	20-21
--	-------

 Beta	22-25
---	-------

End Panels (continued):

 Delicato	26-29
--	-------

 Element	30-31
---	-------

 Fusion	32-33
--	-------

 Princeton	34-35
--	-------

 Ronda	36-39
---	-------

 Vista	40-41
---	-------

 Slatwall	42-53
--	-------

 Slatwall - 1" Thick	54-65
---	-------

Warranty	66
-----------------	-----------

Terms & Conditions	67
-------------------------------	-----------

WOODS & FINISHES:

Natural Maple

Standard



Natural Clear – M-NA

Maple Finishes

The following stains are available, add 10% to list



Castle Oak – M-CO



Honey Oak – M-HO

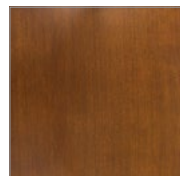

English Oak – M-EN

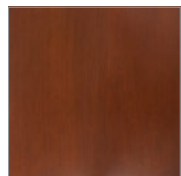

Victorian Cherry – M-VI

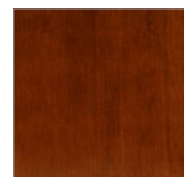

Richmond Cherry – M-RC



Mahogany – M-MA



Java – M-JA



Wenge – M-WE

Natural Red Oak

Standard

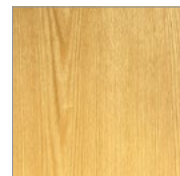

Natural Clear – O-NA

Red Oak Finishes

The following stains are available, add 10% to list

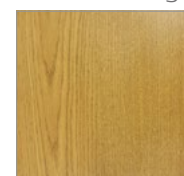

Castle Oak – O-CO

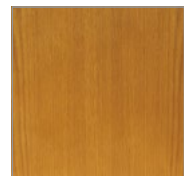

Honey Oak – O-HO

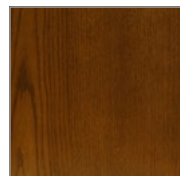

English Oak – O-EN



Victorian Cherry – O-VI



Richmond Cherry – O-RC



Mahogany – O-MA



Java – O-JA



Wenge – O-WE

Natural Cherry

Add 20% to list

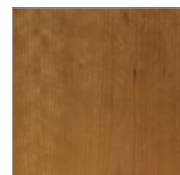

Natural Clear – C-NA

Cherry Finishes

The following stains are available, add 30% to list



Honey Oak – C-HO



Richmond Cherry – C-RC

Natural Walnut

Add 20% to list

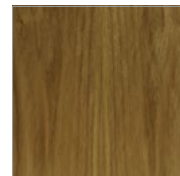

Natural Clear – W-NA

Walnut Finishes

The following stain is available, add 30% to list



Java – W-JA

HARDWOODS: All hardwood materials used in the manufacturing of Palmieri products shall be Northern grown hardwoods. Hardwoods will be air and kiln dried to a moisture content of 5-7%. All hardwoods shall be of grade "A" material, free of material stains, imperfections, conformity of grain, texture and color. Hardwood species shall be Northern grown Red Oak, Clear White Northern Maple and Birch. American Cherry and Honduras Mahogany and Walnut are available. Please inquire for pricing.

VENEER: Exposed face veneers shall be not less than 1/28" thick plain sliced veneers. Veneers are to be selected for conformity of grain direction and color. Veneers are to be stitched tightly in a book match, slip match or plain sliced configuration. Unexposed veneers are to be of hardwood but not selected for color, or grain quality. Veneers are not to be lap joined or reveal any tape or glue lines.

PARTICLE BOARD CORE: The particleboard shall be formed of wood chips, bonded with a water resistance adhesive. The particleboard material is to be of a high density 45 lbs/cu. ft. having a minimum average modulus of rupture of 2400 psi and a minimum average modulus of elasticity of 4,000,000 psi.

VENEER CORE: Veneer core is to be constructed with odd numbers of plies. Each ply is to be laminated in pairs and cross banded in opposite directions with grain direction at a 90 degree angle to the grain of the center core. All plies are to be free from knots, wrinkles, laps or other natural or manufacturing defects.

LUMBER CORE: Lumber core is to be of the highest quality grade. Grade "A" select stock. Lumber core shall be constructed of solid random width strips not less than 2" wide nor more than 3 1/2" wide by 1" thick. Wood strips will be free from knots or other defects. All strips will be tightly joined using water resistance adhesives.

HIGH PRESSURE LAMINATE: Work surface laminate shall be .050" thick and used with balancing backer sheet of no less than .028" thick. Laminate shall conform to standards set by the National Electrical Manufacturers' Association (NEMA).

FINISHING PROCEDURES: All materials shall be inspected and treated with a final sanding and polishing operation before any staining and final finishing can be performed. All machine and mill marks are to be removed. Once the polishing and sanding has been performed, the furniture will then undergo the following stain and finishing procedures:

Step 1 A base stain will be uniformly applied, wiped and then allowed to dry under factory controlled conditions.

Step 2 A uniform coat of sealer will be applied and allowed to dry.



Step 3 Sealer will be lightly sanded using 240 grit silicon paper.



Step 4 A catalytic lacquer of 34-45 degree sheen is evenly applied and allowed to dry under factory controlled conditions.

METAL FINISHING PROCEDURES: All metal components are thoroughly cleaned and coated electrostatically with an epoxy powder coat paint finish. The metal components are then oven baked and cured for a lasting finish.

MODEL NUMBER	PRODUCT	WIDTH	DEPTH	HEIGHT	WEIGHT	VOLUME	PRICE	DESCRIPTION
	Bannister - Canopy Top:							
CT-BA-14-36	Single Face, 14" Depth	36"	14"	1 1/4"	30 Lbs.		\$ 506	Canopy tops shall be 1-1/4" thick 3-ply high density particle core. Top shall receive a .050" thick plastic laminate surface and a backer sheet of .020" thick for balanced construction. The edges shall be banded with a 3/4" thick x 1-1/4" high solid external band with the bottom edge chamfered forming a knife edge detail. Edges shall be banded to top after the top and bottom laminate sheets have been applied. Edges shall be butt joined together. Single face tops shall receive edges on 2 short and 1 long edge and double face tops shall receive edges on 2 long edges and short edges banded on end units only. Tops longer than 108" shall be joined together using tight joined fasteners.
CT-BA-14-72		72"	14"	1 1/4"	60 Lbs.		\$ 706	
CT-BA-14-108		108"	14"	1 1/4"	90 Lbs.		\$ 900	
CT-BA-14-144		144"	14"	1 1/4"	120 Lbs.		\$ 1,263	
CT-BA-14-180		180"	14"	1 1/4"	150 Lbs.		\$ 1,400	
CT-BA-14-216		216"	14"	1 1/4"	180 Lbs.		\$ 1,594	
CT-BA-14-252		252"	14"	1 1/4"	210 Lbs.		\$ 1,900	
CT-BA-14-288		288"	14"	1 1/4"	240 Lbs.		\$ 2,094	
CT-BA-26-36	Double Face, 26" Depth	36"	26"	1 1/4"	60 Lbs.		\$ 819	
CT-BA-26-72		72"	26"	1 1/4"	120 Lbs.		\$ 1,163	
CT-BA-26-108		108"	26"	1 1/4"	180 Lbs.		\$ 1,569	
CT-BA-26-144		144"	26"	1 1/4"	240 Lbs.		\$ 1,944	
CT-BA-26-180		180"	26"	1 1/4"	300 Lbs.		\$ 2,350	
CT-BA-26-216		216"	26"	1 1/4"	360 Lbs.		\$ 2,763	
CT-BA-26-252		252"	26"	1 1/4"	420 Lbs.		\$ 3,138	
CT-BA-26-288		288"	26"	1 1/4"	480 Lbs.		\$ 3,544	
CT-BA-30-36	Double Face, 30" Depth	36"	30"	1 1/4"	75 Lbs.		\$ 888	NOTES: *Canopy tops do not include any hardware. *When ordering tops exact dimensions must be specified, nominal dimensions are inadequate.
CT-BA-30-72		72"	30"	1 1/4"	150 Lbs.		\$ 1,281	
CT-BA-30-108		108"	30"	1 1/4"	180 Lbs.		\$ 1,619	
CT-BA-30-144		144"	30"	1 1/4"	255 Lbs.		\$ 2,188	
CT-BA-30-180		180"	30"	1 1/4"	330 Lbs.		\$ 2,525	
CT-BA-30-216		216"	30"	1 1/4"	405 Lbs.		\$ 2,869	
CT-BA-30-252		252"	30"	1 1/4"	480 Lbs.		\$ 3,444	
CT-BA-30-288		288"	30"	1 1/4"	555 Lbs.		\$ 3,763	

MODEL NUMBER	PRODUCT	WIDTH	DEPTH	HEIGHT	WEIGHT	VOLUME	PRICE	DESCRIPTION
	Beta - Canopy Top:							
CT-BT-14-36	Single Face, 14" Depth	36"	14"	1 1/4"	30 Lbs.		\$ 338	Canopy tops shall be 1-1/4" thick 3-ply high density particle core. Top shall receive a .050" thick plastic laminate surface and a backer sheet of .020" thick for balanced construction. The edges shall be banded with a 1/4" thick x 1-1/4" high solid internal band. Edges shall be banded to top before laminate sheets have been applied, all edges shall be eased. Single face tops shall receive edges on 2 short and 1 long edge and double face tops shall receive edges on 2 long edges and short edges banded on end units only. Tops longer than 108" shall be joined together using tight joined fasteners.
CT-BT-14-72		72"	14"	1 1/4"	60 Lbs.		\$ 469	
CT-BT-14-108		108"	14"	1 1/4"	90 Lbs.		\$ 631	
CT-BT-14-144		144"	14"	1 1/4"	120 Lbs.		\$ 944	
CT-BT-14-180		180"	14"	1 1/4"	150 Lbs.		\$ 1,088	
CT-BT-14-216		216"	14"	1 1/4"	180 Lbs.		\$ 1,244	
CT-BT-14-252		252"	14"	1 1/4"	210 Lbs.		\$ 1,569	
CT-BT-14-288		288"	14"	1 1/4"	240 Lbs.		\$ 1,719	
CT-BT-26-36	Double Face, 26" Depth	36"	26"	1 1/4"	60 Lbs.		\$ 475	
CT-BT-26-72		72"	26"	1 1/4"	120 Lbs.		\$ 681	
CT-BT-26-108		108"	26"	1 1/4"	180 Lbs.		\$ 856	
CT-BT-26-144		144"	26"	1 1/4"	240 Lbs.		\$ 1,319	
CT-BT-26-180		180"	26"	1 1/4"	300 Lbs.		\$ 1,513	
CT-BT-26-216		216"	26"	1 1/4"	360 Lbs.		\$ 1,694	
CT-BT-26-252		252"	26"	1 1/4"	420 Lbs.		\$ 2,188	
CT-BT-26-288		288"	26"	1 1/4"	480 Lbs.		\$ 2,369	
CT-BT-30-36	Double Face, 30" Depth	36"	30"	1 1/4"	75 Lbs.		\$ 544	*Canopy tops do not include any hardware. *When ordering tops exact dimensions must be specified, nominal dimensions are inadequate.
CT-BT-30-72		72"	30"	1 1/4"	150 Lbs.		\$ 844	
CT-BT-30-108		108"	30"	1 1/4"	225 Lbs.		\$ 906	
CT-BT-30-144		144"	30"	1 1/4"	300 Lbs.		\$ 1,425	
CT-BT-30-180		180"	30"	1 1/4"	375 Lbs.		\$ 1,731	
CT-BT-30-216		216"	30"	1 1/4"	450 Lbs.		\$ 1,788	
CT-BT-30-252		252"	30"	1 1/4"	525 Lbs.		\$ 2,275	
CT-BT-30-288		288"	30"	1 1/4"	600 Lbs.		\$ 2,638	

MODEL NUMBER	PRODUCT	WIDTH	DEPTH	HEIGHT	WEIGHT	VOLUME	PRICE	DESCRIPTION	
	Delicato - Canopy Top:								
CT-DL-14-36	Single Face, 14" Depth	36"	14"	1 1/4"	30 Lbs.		\$ 381	Canopy tops shall be 1-1/4" thick 3-ply high density particle core. Top shall receive a .050" thick plastic laminate surface and a backer sheet of .020" thick for balanced construction. The edges shall be banded with a 1/2" thick x 1-1/4" high solid external band. Edges shall be banded to top after the top and bottom laminate sheets have been applied. Single face tops shall receive edges on 2 short and 1 long edge and double face tops shall receive edges on 2 long edges and short edges banded on end units only. Tops longer than 108" shall be joined together using tight joined fasteners.	
CT-DL-14-72		72"	14"	1 1/4"	60 Lbs.		\$ 538		
CT-DL-14-108		108"	14"	1 1/4"	90 Lbs.		\$ 700		
CT-DL-14-144		144"	14"	1 1/4"	120 Lbs.		\$ 1,069		
CT-DL-14-180		180"	14"	1 1/4"	150 Lbs.		\$ 1,225		
CT-DL-14-216		216"	14"	1 1/4"	180 Lbs.		\$ 1,394		
CT-DL-14-252		252"	14"	1 1/4"	210 Lbs.		\$ 1,763		
CT-DL-14-288		288"	14"	1 1/4"	240 Lbs.		\$ 1,919		
	Double Face, 26" Depth								
CT-DL-26-36		36"	26"	1 1/4"	60 Lbs.		\$ 544		
CT-DL-26-72		72"	26"	1 1/4"	120 Lbs.		\$ 763		
CT-DL-26-108		108"	26"	1 1/4"	180 Lbs.		\$ 956		
CT-DL-26-144		144"	26"	1 1/4"	240 Lbs.		\$ 1,419		
CT-DL-26-180		180"	26"	1 1/4"	300 Lbs.		\$ 1,700		
CT-DL-26-216		216"	26"	1 1/4"	360 Lbs.		\$ 1,900		
CT-DL-26-252		252"	26"	1 1/4"	420 Lbs.		\$ 2,444		
CT-DL-26-288		288"	26"	1 1/4"	480 Lbs.		\$ 2,638		
NOTES:									
*Canopy tops do not include any hardware.									
*When ordering tops exact dimensions must be specified, nominal dimensions are inadequate.									
Double Face, 30" Depth									
CT-DL-30-36		36"	30"	1 1/4"	75 Lbs.		\$ 606		
CT-DL-30-72		72"	30"	1 1/4"	150 Lbs.		\$ 950		
CT-DL-30-108		108"	30"	1 1/4"	225 Lbs.		\$ 1,013		
CT-DL-30-144		144"	30"	1 1/4"	300 Lbs.		\$ 1,594		
CT-DL-30-180		180"	30"	1 1/4"	375 Lbs.		\$ 1,944		
CT-DL-30-216		216"	30"	1 1/4"	450 Lbs.		\$ 2,006		
CT-DL-30-252		252"	30"	1 1/4"	525 Lbs.		\$ 2,594		
CT-DL-30-288		288"	30"	1 1/4"	600 Lbs.		\$ 2,938		

MODEL NUMBER	PRODUCT	WIDTH	DEPTH	HEIGHT	WEIGHT	VOLUME	PRICE	DESCRIPTION
	Element - Canopy Top:							
CT-EL-14-36	Single Face, 14" Depth	36"	14"	1 1/4"	30 Lbs.		\$ 363	Canopy tops shall be 1-1/4" thick 3-ply high density particle core. Top shall receive a .050" thick plastic laminate surface and a backer sheet of not less than .020" thick for balanced construction. The edges shall be banded with a 1/4" thick x 1-1/4" high solid external band. Edges shall be banded to top after laminate sheets have been applied. All edges are eased. Single face tops shall receive edges on 2 short and 1 long edge and double face tops shall receive edges on 2 long sides only. Tops longer than 108" shall be joined together using tight joined fasteners.
CT-EL-14-72		72"	14"	1 1/4"	60 Lbs.		\$ 513	
CT-EL-14-108		108"	14"	1 1/4"	90 Lbs.		\$ 669	
CT-EL-14-144		144"	14"	1 1/4"	120 Lbs.		\$ 1,013	
CT-EL-14-180		180"	14"	1 1/4"	150 Lbs.		\$ 1,169	
CT-EL-14-216		216"	14"	1 1/4"	180 Lbs.		\$ 1,338	
CT-EL-14-252		252"	14"	1 1/4"	210 Lbs.		\$ 1,681	
CT-EL-14-288		288"	14"	1 1/4"	240 Lbs.		\$ 1,831	
								
CT-EL-26-36	Double Face, 26" Depth	36"	26"	1 1/4"	60 Lbs.		\$ 506	
CT-EL-26-72		72"	26"	1 1/4"	120 Lbs.		\$ 719	
CT-EL-26-108		108"	26"	1 1/4"	180 Lbs.		\$ 906	
CT-EL-26-144		144"	26"	1 1/4"	240 Lbs.		\$ 1,350	
CT-EL-26-180		180"	26"	1 1/4"	300 Lbs.		\$ 1,619	
CT-EL-26-216		216"	26"	1 1/4"	360 Lbs.		\$ 1,806	
CT-EL-26-252		252"	26"	1 1/4"	420 Lbs.		\$ 2,331	
CT-EL-26-288		288"	26"	1 1/4"	480 Lbs.		\$ 2,531	
								NOTES:
								*Canopy tops do not include hardware.
								*When ordering tops, exact dimensions are required. Nominal dimensions are inadequate.
CT-EL-30-36	Double Face, 30" Depth	36"	30"	1 1/4"	75 Lbs.		\$ 575	
CT-EL-30-72		72"	30"	1 1/4"	150 Lbs.		\$ 900	
CT-EL-30-108		108"	30"	1 1/4"	225 Lbs.		\$ 956	
CT-EL-30-144		144"	30"	1 1/4"	300 Lbs.		\$ 1,519	
CT-EL-30-180		180"	30"	1 1/4"	375 Lbs.		\$ 1,850	
CT-EL-30-216		216"	30"	1 1/4"	450 Lbs.		\$ 1,900	
CT-EL-30-252		252"	30"	1 1/4"	525 Lbs.		\$ 2,475	
CT-EL-30-288		288"	30"	1 1/4"	600 Lbs.		\$ 2,800	

MODEL NUMBER	PRODUCT	WIDTH	DEPTH	HEIGHT	WEIGHT	VOLUME	PRICE	DESCRIPTION
	Ronda - Canopy Top:							
	Single Face, 14" Depth							
CT-RD-14-36		36"	14"	1 1/4"	30 Lbs.		\$ 400	Canopy tops shall be 1-1/4" thick 3-ply high density particle core. Top shall receive a .050" thick plastic laminate surface and a backer sheet of .020" thick for balanced construction. The edges shall be banded with a 3/4" thick x 1-1/4" high solid external band with top and bottom edges radiused 1/2" forming a full bullnose edge detail. Edges shall be banded to top after the top and bottom laminate sheets have been applied. Edges shall be butt joined together. Single face tops shall receive edges on 2 short and 1 long edge and double face tops shall receive edges on 2 long edges and short edges banded on end units only. Tops longer than 108" shall be joined together using tight joined fasteners.
CT-RD-14-72		72"	14"	1 1/4"	60 Lbs.		\$ 550	
CT-RD-14-108		108"	14"	1 1/4"	90 Lbs.		\$ 731	
CT-RD-14-144		144"	14"	1 1/4"	120 Lbs.		\$ 1,094	
CT-RD-14-180		180"	14"	1 1/4"	150 Lbs.		\$ 1,269	
CT-RD-14-216		216"	14"	1 1/4"	180 Lbs.		\$ 1,444	
CT-RD-14-252		252"	14"	1 1/4"	210 Lbs.		\$ 1,819	
CT-RD-14-288		288"	14"	1 1/4"	240 Lbs.		\$ 1,988	
	Double Face, 26" Depth							
CT-RD-26-36		36"	26"	1 1/4"	60 Lbs.		\$ 556	
CT-RD-26-72		72"	26"	1 1/4"	120 Lbs.		\$ 781	
CT-RD-26-108		108"	26"	1 1/4"	180 Lbs.		\$ 994	
CT-RD-26-144		144"	26"	1 1/4"	240 Lbs.		\$ 1,469	
CT-RD-26-180		180"	26"	1 1/4"	300 Lbs.		\$ 1,763	
CT-RD-26-216		216"	26"	1 1/4"	360 Lbs.		\$ 1,963	
CT-RD-26-252		252"	26"	1 1/4"	420 Lbs.		\$ 2,531	
CT-RD-26-288		288"	26"	1 1/4"	480 Lbs.		\$ 2,731	
	Double Face, 30" Depth							
CT-RD-30-36		36"	30"	1 1/4"	75 Lbs.		\$ 638	
CT-RD-30-72		72"	30"	1 1/4"	150 Lbs.		\$ 988	
CT-RD-30-108		108"	30"	1 1/4"	225 Lbs.		\$ 1,031	
CT-RD-30-144		144"	30"	1 1/4"	300 Lbs.		\$ 1,650	
CT-RD-30-180		180"	30"	1 1/4"	375 Lbs.		\$ 2,025	
CT-RD-30-216		216"	30"	1 1/4"	450 Lbs.		\$ 2,113	
CT-RD-30-252		252"	30"	1 1/4"	525 Lbs.		\$ 2,688	
CT-RD-30-288		288"	30"	1 1/4"	600 Lbs.		\$ 3,031	

NOTES:

*Canopy tops do not include any hardware.

*When ordering tops exact dimensions must be specified, nominal dimensions are inadequate.

MODEL NUMBER	PRODUCT	WIDTH	DEPTH	HEIGHT	WEIGHT	VOLUME	PRICE	DESCRIPTION
	Aspen - End Panel:							PANEL CONSTRUCTION:
EP-AP-4810	Single Face, 48" Height	10"	1 1/4"	48"	14 Lbs.	1 Cu.Ft	\$ 606	End panels constructed from 1-1/4" thick high density particleboard core, with grade "A" veneer faces. End panels shall be externally banded top and bottom with 2-1/2" wide a 1-1/4" thick solid hardwood edges. The two long vertical edges will be banded with 1/4" thick x 1-1/4" wide solid hardwood, all panel edges and corners will be eased.
EP-AP-4812		12"	1 1/4"	48"	14 Lbs.	1 Cu.Ft	\$ 694	
EP-AP-4814		14"	1 1/4"	48"	14 Lbs.	1 Cu.Ft	\$ 781	
EP-AP-6610	Single Face, 66" Height	10"	1 1/4"	66"	16 Lbs.	1 Cu.Ft	\$ 656	
EP-AP-6612		12"	1 1/4"	66"	16 Lbs.	1 Cu.Ft	\$ 756	
EP-AP-6614		14"	1 1/4"	66"	16 Lbs.	1 Cu.Ft	\$ 844	
EP-AP-7810	Single Face, 78" Height	10"	1 1/4"	78"	20 Lbs.	2 Cu.Ft	\$ 781	
EP-AP-7812		12"	1 1/4"	78"	20 Lbs.	2 Cu.Ft	\$ 869	
EP-AP-7814		14"	1 1/4"	78"	20 Lbs.	2 Cu.Ft	\$ 981	
EP-AP-9610	Single Face, 96" Height	10"	1 1/4"	96"	20 Lbs.	2 Cu.Ft	\$ 806	
EP-AP-9612		12"	1 1/4"	96"	20 Lbs.	2 Cu.Ft	\$ 925	
EP-AP-9614		14"	1 1/4"	96"	20 Lbs.	2 Cu.Ft	\$ 1,044	
EP-AP-4820	Double Face, 48" Height	20"	1 1/4"	48"	28 Lbs.	1 Cu.Ft	\$ 869	NOTES: *End panels do include any hardware. *When ordering panels exact dimensions must be specified, nominal dimensions are inadequate.
EP-AP-4824		24"	1 1/4"	48"	28 Lbs.	2 Cu.Ft	\$ 1,006	
EP-AP-4828		28"	1 1/4"	48"	28 Lbs.	2 Cu.Ft	\$ 1,144	
EP-AP-4830		30"	1 1/4"	48"	28 Lbs.	2 Cu.Ft	\$ 1,219	
EP-AP-6620	Double Face, 66" Height	20"	1 1/4"	66"	32 Lbs.	2 Cu.Ft	\$ 950	
EP-AP-6624		24"	1 1/4"	66"	32 Lbs.	2 Cu.Ft	\$ 1,106	
EP-AP-6628		28"	1 1/4"	66"	32 Lbs.	3 Cu.Ft	\$ 1,256	
EP-AP-6630		30"	1 1/4"	66"	32 Lbs.	3 Cu.Ft	\$ 1,338	
EP-AP-7820	Double Face, 78" Height	20"	1 1/4"	78"	40 Lbs.	3 Cu.Ft	\$ 1,113	
EP-AP-7824		24"	1 1/4"	78"	40 Lbs.	3 Cu.Ft	\$ 1,294	
EP-AP-7828		28"	1 1/4"	78"	40 Lbs.	4 Cu.Ft	\$ 1,481	
EP-AP-7830		30"	1 1/4"	78"	40 Lbs.	4 Cu.Ft	\$ 1,569	
EP-AP-9620	Double Face, 96" Height	20"	1 1/4"	96"	40 Lbs.	3 Cu.Ft	\$ 1,194	
EP-AP-9624		24"	1 1/4"	96"	40 Lbs.	3 Cu.Ft	\$ 1,394	
EP-AP-9628		28"	1 1/4"	96"	40 Lbs.	4 Cu.Ft	\$ 1,594	
EP-AP-9630		30"	1 1/4"	96"	40 Lbs.	4 Cu.Ft	\$ 1,694	

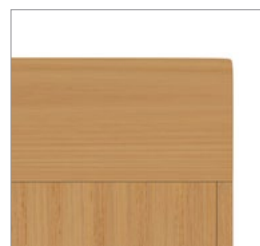







MODEL NUMBER	PRODUCT	WIDTH	DEPTH	HEIGHT	WEIGHT	VOLUME	PRICE	DESCRIPTION
Beta - End Panel:		PANEL CONSTRUCTION:						
EP-BT-4810	Single Face, 48" Height	10"	3/4"	48"	14 Lbs.	1 Cu.Ft	\$ 194	Panels constructed from 3/4" thick 3-ply particleboard core with grade "A" select veneers both faces. All edges banded with 1/4" thick solid external banding.
EP-BT-4812		12"	3/4"	48"	14 Lbs.	1 Cu.Ft	\$ 219	
EP-BT-4814		14"	3/4"	48"	14 Lbs.	1 Cu.Ft	\$ 244	
EP-BT-6610	Single Face, 66" Height	10"	3/4"	66"	16 Lbs.	1 Cu.Ft	\$ 225	NOTES: *End Panels do not include any hardware.
EP-BT-6612		12"	3/4"	66"	16 Lbs.	1 Cu.Ft	\$ 263	
EP-BT-6614		14"	3/4"	66"	16 Lbs.	1 Cu.Ft	\$ 294	
EP-BT-7810	Single Face, 78" Height	10"	3/4"	78"	20 Lbs.	1 Cu.Ft	\$ 275	*When ordering panels exact dimensions must be specified, nominal dimensions are inadequate.
EP-BT-7812		12"	3/4"	78"	20 Lbs.	1 Cu.Ft	\$ 319	
EP-BT-7814		14"	3/4"	78"	20 Lbs.	1 Cu.Ft	\$ 369	
EP-BT-9610	Single Face, 96" Height	10"	3/4"	96"	20 Lbs.	1 Cu.Ft	\$ 306	OPTION: High pressure plastic laminate both faces and laminate self edged.
EP-BT-9612		12"	3/4"	96"	20 Lbs.	1 Cu.Ft	\$ 356	
EP-BT-9614		14"	3/4"	96"	20 Lbs.	1 Cu.Ft	\$ 406	
EP-BT-4810P	Single Face, 48" Height	10"	3/4"	48"	14 Lbs.	1 Cu.Ft	\$ 206	
EP-BT-4812P	Laminate, Self Edge	12"	3/4"	48"	14 Lbs.	1 Cu.Ft	\$ 231	
EP-BT-4814P		14"	3/4"	48"	14 Lbs.	1 Cu.Ft	\$ 256	
EP-BT-6610P	Single Face, 66" Height	10"	3/4"	66"	16 Lbs.	1 Cu.Ft	\$ 238	
EP-BT-6612P	Laminate, Self Edge	12"	3/4"	66"	16 Lbs.	1 Cu.Ft	\$ 275	
EP-BT-6614P		14"	3/4"	66"	16 Lbs.	1 Cu.Ft	\$ 313	
EP-BT-7810P	Single Face, 78" Height	10"	3/4"	78"	20 Lbs.	1 Cu.Ft	\$ 288	
EP-BT-7812P	Laminate, Self Edge	12"	3/4"	78"	20 Lbs.	1 Cu.Ft	\$ 338	
EP-BT-7814P		14"	3/4"	78"	20 Lbs.	1 Cu.Ft	\$ 388	
EP-BT-9610P	Single Face, 96" Height	10"	3/4"	96"	20 Lbs.	1 Cu.Ft	\$ 325	
EP-BT-9612P	Laminate, Self Edge	12"	3/4"	96"	20 Lbs.	1 Cu.Ft	\$ 375	
EP-BT-9614P		14"	3/4"	96"	20 Lbs.	1 Cu.Ft	\$ 431	







MODEL NUMBER	PRODUCT	WIDTH	DEPTH	HEIGHT	WEIGHT	VOLUME	PRICE	DESCRIPTION
	Beta - End Panel:							PANEL CONSTRUCTION:
EP-BT-4820	Double Face, 48" Height	20"	3/4"	48"	28 Lbs.	1 Cu.Ft	\$ 338	Panels constructed from 3/4" thick 3-ply particleboard core with grade "A" select veneers both faces. All edges banded with 1/4" thick solid external banding.
EP-BT-4824		24"	3/4"	48"	28 Lbs.	1 Cu.Ft	\$ 394	
EP-BT-4828		28"	3/4"	48"	28 Lbs.	1 Cu.Ft	\$ 450	
EP-BT-4830		30"	3/4"	48"	28 Lbs.	1 Cu.Ft	\$ 481	
EP-BT-6620	Double Face, 66" Height	20"	3/4"	66"	32 Lbs.	1 Cu.Ft	\$ 400	NOTES: *End Panels do not include any hardware. *When ordering panels exact dimensions must be specified, nominal dimensions are inadequate.
EP-BT-6624		24"	3/4"	66"	32 Lbs.	2 Cu.Ft	\$ 463	
EP-BT-6628		28"	3/4"	66"	32 Lbs.	2 Cu.Ft	\$ 531	
EP-BT-6630		30"	3/4"	66"	32 Lbs.	2 Cu.Ft	\$ 563	
EP-BT-7820	Double Face, 78" Height	20"	3/4"	78"	40 Lbs.	2 Cu.Ft	\$ 513	OPTION: High pressure plastic laminate both faces and laminate self edged.
EP-BT-7824		24"	3/4"	78"	40 Lbs.	2 Cu.Ft	\$ 606	
EP-BT-7828		28"	3/4"	78"	40 Lbs.	2 Cu.Ft	\$ 688	
EP-BT-7830		30"	3/4"	78"	40 Lbs.	2 Cu.Ft	\$ 738	
EP-BT-9620	Double Face, 96" Height	20"	3/4"	96"	40 Lbs.	2 Cu.Ft	\$ 575	
EP-BT-9624		24"	3/4"	96"	40 Lbs.	2 Cu.Ft	\$ 669	
EP-BT-9628		28"	3/4"	96"	40 Lbs.	2 Cu.Ft	\$ 769	
EP-BT-9630		30"	3/4"	96"	40 Lbs.	2 Cu.Ft	\$ 819	
EP-BT-4820P	Double Face, 48" Height	20"	3/4"	48"	28 Lbs.	1 Cu.Ft	\$ 356	
EP-BT-4824P	Laminate, Self Edge	24"	3/4"	48"	28 Lbs.	1 Cu.Ft	\$ 413	
EP-BT-4828P		28"	3/4"	48"	28 Lbs.	1 Cu.Ft	\$ 475	
EP-BT-4830P		30"	3/4"	48"	28 Lbs.	1 Cu.Ft	\$ 506	
EP-BT-6620P	Double Face, 66" Height	20"	3/4"	66"	32 Lbs.	1 Cu.Ft	\$ 425	
EP-BT-6624P	Laminate, Self Edge	24"	3/4"	66"	32 Lbs.	2 Cu.Ft	\$ 488	
EP-BT-6628P		28"	3/4"	66"	32 Lbs.	2 Cu.Ft	\$ 563	
EP-BT-6630P		30"	3/4"	66"	32 Lbs.	2 Cu.Ft	\$ 594	
EP-BT-7820P	Double Face, 78" Height	20"	3/4"	78"	40 Lbs.	2 Cu.Ft	\$ 544	
EP-BT-7824P	Laminate, Self Edge	24"	3/4"	78"	40 Lbs.	2 Cu.Ft	\$ 638	
EP-BT-7828P		28"	3/4"	78"	40 Lbs.	2 Cu.Ft	\$ 725	
EP-BT-7830P		30"	3/4"	78"	40 Lbs.	2 Cu.Ft	\$ 775	
EP-BT-9620P	Double Face, 96" Height	20"	3/4"	96"	40 Lbs.	2 Cu.Ft	\$ 606	
EP-BT-9624P	Laminate, Self Edge	24"	3/4"	96"	40 Lbs.	2 Cu.Ft	\$ 706	
EP-BT-9628P		28"	3/4"	96"	40 Lbs.	2 Cu.Ft	\$ 806	
EP-BT-9630P		30"	3/4"	96"	40 Lbs.	2 Cu.Ft	\$ 863	

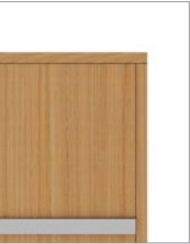

MODEL NUMBER	PRODUCT	WIDTH	DEPTH	HEIGHT	WEIGHT	VOLUME	PRICE	DESCRIPTION	
Delicato - End Panel:		PANEL CONSTRUCTION:							
	EP-DL-4810	Single Face, 48" Height	10"	1"	48"	14 Lbs.	1 Cu.Ft	\$ 281	Panels constructed from 1" thick 3-ply particleboard core with grade "A" select veneers both faces. All edges banded with 1/4" thick solid external banding. All edges will be eased. NOTES: *End Panels do not include any hardware. *When ordering panels exact dimensions must be specified, nominal dimensions are inadequate. OPTION: High pressure plastic laminate both faces with 1/4" thick external solid band edges.
	EP-DL-4812		12"	1"	48"	14 Lbs.	1 Cu.Ft	\$ 325	
	EP-DL-4814		14"	1"	48"	14 Lbs.	1 Cu.Ft	\$ 363	
	EP-DL-6610	Single Face, 66" Height	10"	1"	66"	16 Lbs.	1 Cu.Ft	\$ 331	
	EP-DL-6612		12"	1"	66"	16 Lbs.	1 Cu.Ft	\$ 375	
	EP-DL-6614		14"	1"	66"	16 Lbs.	1 Cu.Ft	\$ 425	
	EP-DL-7810	Single Face, 78" Height	10"	1"	78"	20 Lbs.	1 Cu.Ft	\$ 413	
	EP-DL-7812		12"	1"	78"	20 Lbs.	1 Cu.Ft	\$ 475	
	EP-DL-7814		14"	1"	78"	20 Lbs.	1 Cu.Ft	\$ 544	
	EP-DL-9610	Single Face, 96" Height	10"	1"	96"	20 Lbs.	1 Cu.Ft	\$ 450	
	EP-DL-9612		12"	1"	96"	20 Lbs.	1 Cu.Ft	\$ 531	
	EP-DL-9614		14"	1"	96"	20 Lbs.	1 Cu.Ft	\$ 606	
	EP-DL-4810PX	Single Face, 48" Height	10"	1"	48"	14 Lbs.	1 Cu.Ft	\$ 306	
	EP-DL-4812PX	Laminate, Wood Edge	12"	1"	48"	14 Lbs.	1 Cu.Ft	\$ 356	
	EP-DL-4814PX		14"	1"	48"	14 Lbs.	1 Cu.Ft	\$ 394	
	EP-DL-6610PX	Single Face, 66" Height	10"	1"	66"	16 Lbs.	1 Cu.Ft	\$ 363	
	EP-DL-6612PX	Laminate, Wood Edge	12"	1"	66"	16 Lbs.	1 Cu.Ft	\$ 406	
	EP-DL-6614PX		14"	1"	66"	16 Lbs.	1 Cu.Ft	\$ 463	
	EP-DL-7810PX	Single Face, 78" Height	10"	1"	78"	20 Lbs.	1 Cu.Ft	\$ 450	
	EP-DL-7812PX	Laminate, Wood Edge	12"	1"	78"	20 Lbs.	1 Cu.Ft	\$ 513	
	EP-DL-7814PX		14"	1"	78"	20 Lbs.	1 Cu.Ft	\$ 588	
	EP-DL-9610PX	Single Face, 96" Height	10"	1"	96"	20 Lbs.	1 Cu.Ft	\$ 488	
	EP-DL-9612PX	Laminate, Wood Edge	12"	1"	96"	20 Lbs.	1 Cu.Ft	\$ 575	
	EP-DL-9614PX		14"	1"	96"	20 Lbs.	1 Cu.Ft	\$ 656	

MODEL NUMBER	PRODUCT	WIDTH	DEPTH	HEIGHT	WEIGHT	VOLUME	PRICE	DESCRIPTION
	Delicato - End Panel:							PANEL CONSTRUCTION:
EP-DL-4820	Double Face, 48" Height	20"	1"	48"	28 Lbs.	1 Cu.Ft	\$ 475	Panels constructed from 1" thick 3-ply particleboard core with grade "A" select veneers both faces. All edges banded with 1/4" thick solid external banding. All edges will be eased.
EP-DL-4824		24"	1"	48"	28 Lbs.	1 Cu.Ft	\$ 556	
EP-DL-4828		28"	1"	48"	28 Lbs.	1 Cu.Ft	\$ 638	
EP-DL-4830		30"	1"	48"	28 Lbs.	1 Cu.Ft	\$ 681	
EP-DL-6620	Double Face, 66" Height	20"	1"	66"	32 Lbs.	1 Cu.Ft	\$ 563	NOTES: *End Panels do not include any hardware. *When ordering panels exact dimensions must be specified, nominal dimensions are inadequate.
EP-DL-6624		24"	1"	66"	32 Lbs.	2 Cu.Ft	\$ 663	
EP-DL-6628		28"	1"	66"	32 Lbs.	2 Cu.Ft	\$ 750	
EP-DL-6630		30"	1"	66"	32 Lbs.	2 Cu.Ft	\$ 800	
EP-DL-7820	Double Face, 78" Height	20"	1"	78"	40 Lbs.	2 Cu.Ft	\$ 638	OPTION: High pressure plastic laminate both faces with 1/4" thick external solid band edges.
EP-DL-7824		24"	1"	78"	40 Lbs.	2 Cu.Ft	\$ 750	
EP-DL-7828		28"	1"	78"	40 Lbs.	2 Cu.Ft	\$ 856	
EP-DL-7830		30"	1"	78"	40 Lbs.	2 Cu.Ft	\$ 913	
EP-DL-9620	Double Face, 96" Height	20"	1"	96"	40 Lbs.	2 Cu.Ft	\$ 713	
EP-DL-9624		24"	1"	96"	40 Lbs.	2 Cu.Ft	\$ 831	
EP-DL-9628		28"	1"	96"	40 Lbs.	2 Cu.Ft	\$ 956	
EP-DL-9630		30"	1"	96"	40 Lbs.	2 Cu.Ft	\$ 1,019	
EP-DL-4820PX	Double Face, 48" Height	20"	1"	48"	28 Lbs.	1 Cu.Ft	\$ 519	
EP-DL-4824PX	Laminate, Wood Edge	24"	1"	48"	28 Lbs.	1 Cu.Ft	\$ 606	
EP-DL-4828PX		28"	1"	48"	28 Lbs.	1 Cu.Ft	\$ 694	
EP-DL-4830PX		30"	1"	48"	28 Lbs.	1 Cu.Ft	\$ 738	
EP-DL-6620PX	Double Face, 66" Height	20"	1"	66"	32 Lbs.	1 Cu.Ft	\$ 613	
EP-DL-6624PX	Laminate, Wood Edge	24"	1"	66"	32 Lbs.	2 Cu.Ft	\$ 719	
EP-DL-6628PX		28"	1"	66"	32 Lbs.	2 Cu.Ft	\$ 813	
EP-DL-6630PX		30"	1"	66"	32 Lbs.	2 Cu.Ft	\$ 869	
EP-DL-7820PX	Double Face, 78" Height	20"	1"	78"	40 Lbs.	2 Cu.Ft	\$ 694	
EP-DL-7824PX	Laminate, Wood Edge	24"	1"	78"	40 Lbs.	2 Cu.Ft	\$ 813	
EP-DL-7828PX		28"	1"	78"	40 Lbs.	2 Cu.Ft	\$ 931	
EP-DL-7830PX		30"	1"	78"	40 Lbs.	2 Cu.Ft	\$ 994	
EP-DL-9620PX	Double Face, 96" Height	20"	1"	96"	40 Lbs.	2 Cu.Ft	\$ 781	
EP-DL-9624PX	Laminate, Wood Edge	24"	1"	96"	40 Lbs.	2 Cu.Ft	\$ 906	
EP-DL-9628PX		28"	1"	96"	40 Lbs.	2 Cu.Ft	\$ 1,044	
EP-DL-9630PX		30"	1"	96"	40 Lbs.	2 Cu.Ft	\$ 1,113	



MODEL NUMBER	PRODUCT	WIDTH	DEPTH	HEIGHT	WEIGHT	VOLUME	PRICE	DESCRIPTION	
Element - End Panel:		PANEL CONSTRUCTION:							
	EP-EL-4810	Single Face, 48" Height	10"	1 1/4"	48"	14 Lbs.	1 Cu.Ft	\$ 313	Panels constructed from 1-1/4" thick 3-ply particleboard core with grade "A" select veneers both faces. All edges banded with 1/4" thick solid external banding. All edges will be eased. Two horizontal embedded 1/2" wide steel bars will be applied 5" evenly spaced at upper end panel portion. NOTES: *End panels do not include any mounting hardware. *When ordering panels exact dimensions are required, nominal dimensions are inadequate.
	EP-EL-4812		12"	1 1/4"	48"	14 Lbs.	1 Cu.Ft	\$ 356	
	EP-EL-4814		14"	1 1/4"	48"	14 Lbs.	1 Cu.Ft	\$ 400	
	EP-EL-6610	Single Face, 66" Height	10"	1 1/4"	66"	16 Lbs.	1 Cu.Ft	\$ 369	
	EP-EL-6612		12"	1 1/4"	66"	16 Lbs.	1 Cu.Ft	\$ 419	
	EP-EL-6614		14"	1 1/4"	66"	16 Lbs.	1 Cu.Ft	\$ 469	
	EP-EL-7810	Single Face, 78" Height	10"	1 1/4"	78"	20 Lbs.	2 Cu.Ft	\$ 456	
	EP-EL-7812		12"	1 1/4"	78"	20 Lbs.	2 Cu.Ft	\$ 531	
	EP-EL-7814		14"	1 1/4"	78"	20 Lbs.	2 Cu.Ft	\$ 606	
	EP-EL-9610	Single Face, 96" Height	10"	1 1/4"	96"	20 Lbs.	2 Cu.Ft	\$ 500	
	EP-EL-9612		12"	1 1/4"	96"	20 Lbs.	2 Cu.Ft	\$ 588	
	EP-EL-9614		14"	1 1/4"	96"	20 Lbs.	2 Cu.Ft	\$ 675	
	EP-EL-4820	Double Face, 48" Height	20"	1 1/4"	48"	28 Lbs.	1 Cu.Ft	\$ 531	
	EP-EL-4824		24"	1 1/4"	48"	28 Lbs.	2 Cu.Ft	\$ 625	
	EP-EL-4828		28"	1 1/4"	48"	28 Lbs.	2 Cu.Ft	\$ 719	
	EP-EL-4830		30"	1 1/4"	48"	28 Lbs.	2 Cu.Ft	\$ 763	
	EP-EL-6620	Double Face, 66" Height	20"	1 1/4"	66"	32 Lbs.	2 Cu.Ft	\$ 631	
	EP-EL-6624		24"	1 1/4"	66"	32 Lbs.	2 Cu.Ft	\$ 744	
	EP-EL-6628		28"	1 1/4"	66"	32 Lbs.	3 Cu.Ft	\$ 844	
	EP-EL-6630		30"	1 1/4"	66"	32 Lbs.	3 Cu.Ft	\$ 900	
	EP-EL-7820	Double Face, 78" Height	20"	1 1/4"	78"	40 Lbs.	3 Cu.Ft	\$ 756	
	EP-EL-7824		24"	1 1/4"	78"	40 Lbs.	3 Cu.Ft	\$ 881	
	EP-EL-7828		28"	1 1/4"	78"	40 Lbs.	4 Cu.Ft	\$ 1,006	
	EP-EL-7830		30"	1 1/4"	78"	40 Lbs.	4 Cu.Ft	\$ 1,069	
	EP-EL-9620	Double Face, 96" Height	20"	1 1/4"	96"	40 Lbs.	3 Cu.Ft	\$ 825	
	EP-EL-9624		24"	1 1/4"	96"	40 Lbs.	3 Cu.Ft	\$ 988	
	EP-EL-9628		28"	1 1/4"	96"	40 Lbs.	4 Cu.Ft	\$ 1,106	
	EP-EL-9630		30"	1 1/4"	96"	40 Lbs.	4 Cu.Ft	\$ 1,181	

MODEL NUMBER	PRODUCT	WIDTH	DEPTH	HEIGHT	WEIGHT	VOLUME	PRICE	DESCRIPTION
	Fusion - End Panel:							PANEL CONSTRUCTION:
EP-FS-4810	Single Face, 48" Height	10"	1 1/2"	48"	14 Lbs.	1 Cu.Ft	\$ 588	Panels constructed from 1-1/2" thick 3-ply particleboard core with grade "A" select veneers both faces. All edges banded with 1/4" thick solid external banding. Vertical sides will be machined and fitted with key-hole lock fasteners in order to receive 1-1/2" x 1-1/2" square tubular steel posts. Single faced panel receives one post, double faced panel receives two.
EP-FS-4812		12"	1 1/2"	48"	14 Lbs.	1 Cu.Ft	\$ 631	
EP-FS-4814		14"	1 1/2"	48"	14 Lbs.	1 Cu.Ft	\$ 675	
EP-FS-6610	Single Face, 66" Height	10"	1 1/2"	66"	16 Lbs.	1 Cu.Ft	\$ 650	
EP-FS-6612		12"	1 1/2"	66"	16 Lbs.	1 Cu.Ft	\$ 706	
EP-FS-6614		14"	1 1/2"	66"	16 Lbs.	1 Cu.Ft	\$ 750	
EP-FS-7810	Single Face, 78" Height	10"	1 1/2"	78"	20 Lbs.	2 Cu.Ft	\$ 781	
EP-FS-7812		12"	1 1/2"	78"	20 Lbs.	2 Cu.Ft	\$ 850	
EP-FS-7814		14"	1 1/2"	78"	20 Lbs.	2 Cu.Ft	\$ 919	
EP-FS-9610	Single Face, 96" Height	10"	1 1/2"	96"	20 Lbs.	2 Cu.Ft	\$ 844	
EP-FS-9612		12"	1 1/2"	96"	20 Lbs.	2 Cu.Ft	\$ 919	
EP-FS-9614		14"	1 1/2"	96"	20 Lbs.	2 Cu.Ft	\$ 994	
EP-FS-4820	Double Face, 48" Height	20"	1 1/2"	48"	28 Lbs.	1 Cu.Ft	\$ 931	
EP-FS-4824		24"	1 1/2"	48"	28 Lbs.	2 Cu.Ft	\$ 1,019	
EP-FS-4828		28"	1 1/2"	48"	28 Lbs.	2 Cu.Ft	\$ 1,106	
EP-FS-4830		30"	1 1/2"	48"	28 Lbs.	2 Cu.Ft	\$ 1,150	
EP-FS-6620	Double Face, 66" Height	20"	1 1/2"	66"	32 Lbs.	2 Cu.Ft	\$ 1,056	
EP-FS-6624		24"	1 1/2"	66"	32 Lbs.	2 Cu.Ft	\$ 1,163	
EP-FS-6628		28"	1 1/2"	66"	32 Lbs.	3 Cu.Ft	\$ 1,263	
EP-FS-6630		30"	1 1/2"	66"	32 Lbs.	3 Cu.Ft	\$ 1,319	
EP-FS-7820	Double Face, 78" Height	20"	1 1/2"	78"	40 Lbs.	3 Cu.Ft	\$ 1,306	
EP-FS-7824		24"	1 1/2"	78"	40 Lbs.	3 Cu.Ft	\$ 1,444	
EP-FS-7828		28"	1 1/2"	78"	40 Lbs.	4 Cu.Ft	\$ 1,575	
EP-FS-7830		30"	1 1/2"	78"	40 Lbs.	4 Cu.Ft	\$ 1,644	
EP-FS-9620	Double Face, 96" Height	20"	1 1/2"	96"	40 Lbs.	3 Cu.Ft	\$ 1,425	
EP-FS-9624		24"	1 1/2"	96"	40 Lbs.	3 Cu.Ft	\$ 1,581	
EP-FS-9628		28"	1 1/2"	96"	40 Lbs.	4 Cu.Ft	\$ 1,731	
EP-FS-9630		30"	1 1/2"	96"	40 Lbs.	4 Cu.Ft	\$ 1,806	

NOTES:

*End panels do not include any mounting hardware.



*When ordering panels exact dimensions are required, nominal dimensions are inadequate.



MODEL NUMBER	PRODUCT	WIDTH	DEPTH	HEIGHT	WEIGHT	VOLUME	PRICE	DESCRIPTION
Ronda - End Panel:								PANEL CONSTRUCTION:
EP-RD-4810	Single Face, 48" Height	10"	1 1/4"	48"	14 Lbs.	1 Cu.Ft	\$ 294	Panels constructed from 1-1/4" thick 3-ply particleboard core with grade "A" select veneers both faces. All edges banded with 3/4" thick x 1-1/4" solid external banding. All edges will be radiused to a full bullnose detail and all four corners radiused 1/2". Edges shall be butt joined together
EP-RD-4812		12"	1 1/4"	48"	14 Lbs.	1 Cu.Ft	\$ 338	
EP-RD-4814		14"	1 1/4"	48"	14 Lbs.	1 Cu.Ft	\$ 381	
EP-RD-6610	Single Face, 66" Height	10"	1 1/4"	66"	16 Lbs.	1 Cu.Ft	\$ 344	
EP-RD-6612		12"	1 1/4"	66"	16 Lbs.	1 Cu.Ft	\$ 394	
EP-RD-6614		14"	1 1/4"	66"	16 Lbs.	1 Cu.Ft	\$ 444	
EP-RD-7810	Single Face, 78" Height	10"	1 1/4"	78"	20 Lbs.	1 Cu.Ft	\$ 438	NOTES: *End Panels do not include any hardware.
EP-RD-7812		12"	1 1/4"	78"	20 Lbs.	1 Cu.Ft	\$ 506	
EP-RD-7814		14"	1 1/4"	78"	20 Lbs.	1 Cu.Ft	\$ 569	
EP-RD-9610	Single Face, 96" Height	10"	1 1/4"	96"	20 Lbs.	1 Cu.Ft	\$ 481	*When ordering panels exact dimensions must be specified, nominal dimensions are inadequate.
EP-RD-9612		12"	1 1/4"	96"	20 Lbs.	1 Cu.Ft	\$ 556	
EP-RD-9614		14"	1 1/4"	96"	20 Lbs.	1 Cu.Ft	\$ 631	
EP-RD-4810P	Single Face, 48" Height	10"	1 1/4"	48"	14 Lbs.	1 Cu.Ft	\$ 325	OPTIONS: High pressure plastic laminate both faces with 3/4" external bullnose edges.
EP-RD-4812P	Laminate, Bullnose Edge	12"	1 1/4"	48"	14 Lbs.	1 Cu.Ft	\$ 375	
EP-RD-4814P		14"	1 1/4"	48"	14 Lbs.	1 Cu.Ft	\$ 425	
EP-RD-6610P	Single Face, 66" Height	10"	1 1/4"	66"	16 Lbs.	1 Cu.Ft	\$ 381	
EP-RD-6612P	Laminate, Bullnose Edge	12"	1 1/4"	66"	16 Lbs.	1 Cu.Ft	\$ 438	
EP-RD-6614P		14"	1 1/4"	66"	16 Lbs.	1 Cu.Ft	\$ 494	
EP-RD-7810P	Single Face, 78" Height	10"	1 1/4"	78"	20 Lbs.	1 Cu.Ft	\$ 481	
EP-RD-7812P	Laminate, Bullnose Edge	12"	1 1/4"	78"	20 Lbs.	1 Cu.Ft	\$ 563	
EP-RD-7814P		14"	1 1/4"	78"	20 Lbs.	1 Cu.Ft	\$ 631	
EP-RD-9610P	Single Face, 96" Height	10"	1 1/4"	96"	20 Lbs.	1 Cu.Ft	\$ 531	
EP-RD-9612P	Laminate, Bullnose Edge	12"	1 1/4"	96"	20 Lbs.	1 Cu.Ft	\$ 613	
EP-RD-9614P		14"	1 1/4"	96"	20 Lbs.	1 Cu.Ft	\$ 700	

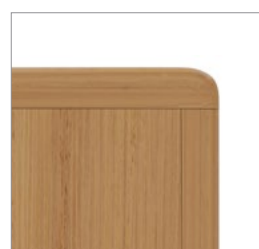



MODEL NUMBER	PRODUCT	WIDTH	DEPTH	HEIGHT	WEIGHT	VOLUME	PRICE	DESCRIPTION
	Ronda - End Panel:							PANEL CONSTRUCTION:
EP-RD-4820	Double Face, 48" Height	20"	1 1/4"	48"	28 Lbs.	1 Cu.Ft	\$ 513	Panels constructed from 1-1/4" thick 3-ply particleboard core with grade "A" select veneers both faces. All edges banded with 3/4" thick x 1-1/4" solid external banding. All edges will be radiused to a full bullnose detail and all four corners radiused 1/2". Edges shall be butt joined together.
EP-RD-4824		24"	1 1/4"	48"	28 Lbs.	1 Cu.Ft	\$ 594	
EP-RD-4828		28"	1 1/4"	48"	28 Lbs.	1 Cu.Ft	\$ 675	
EP-RD-4830		30"	1 1/4"	48"	28 Lbs.	1 Cu.Ft	\$ 719	
EP-RD-6620	Double Face, 66" Height	20"	1 1/4"	66"	32 Lbs.	1 Cu.Ft	\$ 600	NOTES: *End Panels do not include any hardware.
EP-RD-6624		24"	1 1/4"	66"	32 Lbs.	2 Cu.Ft	\$ 694	
EP-RD-6628		28"	1 1/4"	66"	32 Lbs.	2 Cu.Ft	\$ 794	
EP-RD-6630		30"	1 1/4"	66"	32 Lbs.	2 Cu.Ft	\$ 838	
EP-RD-7820	Double Face, 78" Height	20"	1 1/4"	78"	40 Lbs.	2 Cu.Ft	\$ 775	*When ordering panels exact dimensions must be specified, nominal dimensions are inadequate.
EP-RD-7824		24"	1 1/4"	78"	40 Lbs.	2 Cu.Ft	\$ 894	
EP-RD-7828		28"	1 1/4"	78"	40 Lbs.	2 Cu.Ft	\$ 1,025	
EP-RD-7830		30"	1 1/4"	78"	40 Lbs.	2 Cu.Ft	\$ 1,094	
EP-RD-9620	Double Face, 96" Height	20"	1 1/4"	96"	40 Lbs.	2 Cu.Ft	\$ 825	OPTIONS: High pressure plastic laminate both faces with 3/4" external bullnose edges.
EP-RD-9624		24"	1 1/4"	96"	40 Lbs.	2 Cu.Ft	\$ 956	
EP-RD-9628		28"	1 1/4"	96"	40 Lbs.	2 Cu.Ft	\$ 1,094	
EP-RD-9630		30"	1 1/4"	96"	40 Lbs.	2 Cu.Ft	\$ 1,163	
EP-RD-4820P	Double Face, 48" Height	20"	1 1/4"	48"	28 Lbs.	1 Cu.Ft	\$ 569	
EP-RD-4824P	Laminate, Bullnose Edge	24"	1 1/4"	48"	28 Lbs.	1 Cu.Ft	\$ 656	
EP-RD-4828P		28"	1 1/4"	48"	28 Lbs.	1 Cu.Ft	\$ 744	
EP-RD-4830P		30"	1 1/4"	48"	28 Lbs.	1 Cu.Ft	\$ 794	
EP-RD-6620P	Double Face, 66" Height	20"	1 1/4"	66"	32 Lbs.	1 Cu.Ft	\$ 663	
EP-RD-6624P	Laminate, Bullnose Edge	24"	1 1/4"	66"	32 Lbs.	2 Cu.Ft	\$ 769	
EP-RD-6628P		28"	1 1/4"	66"	32 Lbs.	2 Cu.Ft	\$ 875	
EP-RD-6630P		30"	1 1/4"	66"	32 Lbs.	2 Cu.Ft	\$ 925	
EP-RD-7820P	Double Face, 78" Height	20"	1 1/4"	78"	40 Lbs.	2 Cu.Ft	\$ 856	
EP-RD-7824P	Laminate, Bullnose Edge	24"	1 1/4"	78"	40 Lbs.	2 Cu.Ft	\$ 988	
EP-RD-7828P		28"	1 1/4"	78"	40 Lbs.	2 Cu.Ft	\$ 1,131	
EP-RD-7830P		30"	1 1/4"	78"	40 Lbs.	2 Cu.Ft	\$ 1,206	
EP-RD-9620P	Double Face, 96" Height	20"	1 1/4"	96"	40 Lbs.	2 Cu.Ft	\$ 913	
EP-RD-9624P	Laminate, Bullnose Edge	24"	1 1/4"	96"	40 Lbs.	2 Cu.Ft	\$ 1,056	
EP-RD-9628P		28"	1 1/4"	96"	40 Lbs.	2 Cu.Ft	\$ 1,206	
EP-RD-9630P		30"	1 1/4"	96"	40 Lbs.	2 Cu.Ft	\$ 1,281	

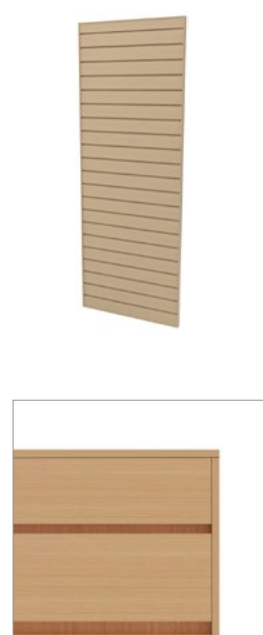

MODEL NUMBER	PRODUCT	WIDTH	DEPTH	HEIGHT	WEIGHT	VOLUME	PRICE	DESCRIPTION	
Vista - End Panel:		PANEL CONSTRUCTION:							
 	EP-VT-4810	Single Face, 48" Height	10"	1"	48"	14 Lbs.	1 Cu.Ft	\$ 825	<p>Panels constructed from 3/4" thick 3-ply particleboard core with grade "A" select veneers both faces. Panels are framed on two vertical sides with 1" thick x 2-1/2" wide solid hardwood. Top member is 1" thick x 2-1/2" wide and bottom member is 1" thick x 5" wide. The panel will then be fitted with a horizontal 1/4" thick x 2-1/2" wide stile member. Upper panel portion square frame with three 1/4" thick x 3/4" wide vertical slats. All edges of panel frame will be eased.</p> <p>NOTES:</p> <p>*End Panels do not include any hardware.</p> <p>*When ordering panels exact dimensions must be specified, nominal dimensions are inadequate.</p>
	EP-VT-4812		12"	1"	48"	14 Lbs.	1 Cu.Ft	\$ 881	
	EP-VT-4814		14"	1"	48"	14 Lbs.	1 Cu.Ft	\$ 938	
	EP-VT-6610	Single Face, 66" Height	10"	1"	66"	16 Lbs.	1 Cu.Ft	\$ 900	
	EP-VT-6612		12"	1"	66"	16 Lbs.	1 Cu.Ft	\$ 963	
	EP-VT-6614		14"	1"	66"	16 Lbs.	1 Cu.Ft	\$ 1,025	
	EP-VT-7810	Single Face, 78" Height	10"	1"	78"	20 Lbs.	2 Cu.Ft	\$ 1,031	
	EP-VT-7812		12"	1"	78"	20 Lbs.	2 Cu.Ft	\$ 1,113	
	EP-VT-7814		14"	1"	78"	20 Lbs.	2 Cu.Ft	\$ 1,194	
	EP-VT-9610	Single Face, 96" Height	10"	1"	96"	20 Lbs.	2 Cu.Ft	\$ 1,094	
	EP-VT-9612		12"	1"	96"	20 Lbs.	2 Cu.Ft	\$ 1,188	
	EP-VT-9614		14"	1"	96"	20 Lbs.	2 Cu.Ft	\$ 1,281	
EP-VT-4820	Double Face, 48" Height	20"	1"	48"	28 Lbs.	1 Cu.Ft	\$ 1,100		
EP-VT-4824		24"	1"	48"	28 Lbs.	2 Cu.Ft	\$ 1,206		
EP-VT-4828		28"	1"	48"	28 Lbs.	2 Cu.Ft	\$ 1,313		
EP-VT-4830		30"	1"	48"	28 Lbs.	2 Cu.Ft	\$ 1,369		
EP-VT-6620	Double Face, 66" Height	20"	1"	66"	32 Lbs.	2 Cu.Ft	\$ 1,219		
EP-VT-6624		24"	1"	66"	32 Lbs.	2 Cu.Ft	\$ 1,344		
EP-VT-6628		28"	1"	66"	32 Lbs.	3 Cu.Ft	\$ 1,469		
EP-VT-6630		30"	1"	66"	32 Lbs.	3 Cu.Ft	\$ 1,538		
EP-VT-7820	Double Face, 78" Height	20"	1"	78"	40 Lbs.	3 Cu.Ft	\$ 1,500		
EP-VT-7824		24"	1"	78"	40 Lbs.	3 Cu.Ft	\$ 1,619		
EP-VT-7828		28"	1"	78"	40 Lbs.	4 Cu.Ft	\$ 1,781		
EP-VT-7830		30"	1"	78"	40 Lbs.	4 Cu.Ft	\$ 1,869		
EP-VT-9620	Double Face, 96" Height	20"	1"	96"	40 Lbs.	3 Cu.Ft	\$ 1,569		
EP-VT-9624		24"	1"	96"	40 Lbs.	3 Cu.Ft	\$ 1,756		
EP-VT-9628		28"	1"	96"	40 Lbs.	4 Cu.Ft	\$ 1,938		
EP-VT-9630		30"	1"	96"	40 Lbs.	4 Cu.Ft	\$ 2,038		

MODEL NUMBER	PRODUCT	WIDTH	DEPTH	HEIGHT	WEIGHT	VOLUME	PRICE	DESCRIPTION
	Slatwall, Unfinished Insert - End Panel:							PANEL CONSTRUCTION:
								Panels constructed from 3/4" thick 3-ply medium density fiberboard with grade "A" select veneers both faces. All edges banded with 1/4" thick solid external banding. All edges will be eased. Grooved slots are unfinished.
	EP-SWU-4810 Single Face, 48" Height	10"	3/4"	48"	14 Lbs.	1 Cu.Ft	\$ 225	
	EP-SWU-4812	12"	3/4"	48"	14 Lbs.	1 Cu.Ft	\$ 256	
	EP-SWU-4814	14"	3/4"	48"	14 Lbs.	1 Cu.Ft	\$ 288	
	EP-SWU-6610 Single Face, 66" Height	10"	3/4"	66"	16 Lbs.	1 Cu.Ft	\$ 269	NOTES:
	EP-SWU-6612	12"	3/4"	66"	16 Lbs.	1 Cu.Ft	\$ 313	*End Panels do not include any hardware.
	EP-SWU-6614	14"	3/4"	66"	16 Lbs.	1 Cu.Ft	\$ 356	
	EP-SWU-7810 Single Face, 78" Height	10"	3/4"	78"	20 Lbs.	1 Cu.Ft	\$ 325	*When ordering panels exact dimensions must be specified, nominal dimensions are inadequate.
	EP-SWU-7812	12"	3/4"	78"	20 Lbs.	1 Cu.Ft	\$ 381	
	EP-SWU-7814	14"	3/4"	78"	20 Lbs.	1 Cu.Ft	\$ 444	
	EP-SWU-9610 Single Face, 96" Height	10"	3/4"	96"	20 Lbs.	1 Cu.Ft	\$ 369	*3/4" thick panels are for wall mount applications and 1" thick panels are for steel shelving mount applications.
	EP-SWU-9612	12"	3/4"	96"	20 Lbs.	1 Cu.Ft	\$ 431	
	EP-SWU-9614	14"	3/4"	96"	20 Lbs.	1 Cu.Ft	\$ 500	*High pressure plastic laminate both faces with 1/4" thick external solid band edge
	EP-SWU-4810PX Single Face, 48" Height	10"	3/4"	48"	14 Lbs.	1 Cu.Ft	\$ 238	
	EP-SWU-4812PX Laminate, Wood Edge	12"	3/4"	48"	14 Lbs.	1 Cu.Ft	\$ 269	
	EP-SWU-4814PX	14"	3/4"	48"	14 Lbs.	1 Cu.Ft	\$ 300	
	EP-SWU-6610PX Single Face, 66" Height	10"	3/4"	66"	16 Lbs.	1 Cu.Ft	\$ 281	
	EP-SWU-6612PX Laminate, Wood Edge	12"	3/4"	66"	16 Lbs.	1 Cu.Ft	\$ 331	
	EP-SWU-6614PX	14"	3/4"	66"	16 Lbs.	1 Cu.Ft	\$ 375	
	EP-SWU-7810PX Single Face, 78" Height	10"	3/4"	78"	20 Lbs.	1 Cu.Ft	\$ 344	
	EP-SWU-7812PX Laminate, Wood Edge	12"	3/4"	78"	20 Lbs.	1 Cu.Ft	\$ 400	
	EP-SWU-7814PX	14"	3/4"	78"	20 Lbs.	1 Cu.Ft	\$ 463	
	EP-SWU-9610PX Single Face, 96" Height	10"	3/4"	96"	20 Lbs.	1 Cu.Ft	\$ 388	
	EP-SWU-9612PX Laminate, Wood Edge	12"	3/4"	96"	20 Lbs.	1 Cu.Ft	\$ 450	
	EP-SWU-9614PX	14"	3/4"	96"	20 Lbs.	1 Cu.Ft	\$ 519	

MODEL NUMBER	PRODUCT	WIDTH	DEPTH	HEIGHT	WEIGHT	VOLUME	PRICE	DESCRIPTION	
	Slatwall, Unfinished Insert - End Panel:							PANEL CONSTRUCTION:	
								Panels constructed from 3/4" thick 3-ply medium density fiberboard with grade "A" select veneers both faces. All edges banded with 1/4" thick solid external banding. All edges will be eased. Grooved slots are unfinished.	
	EP-SWU-4820	Double Face, 48" Height	20"	3/4"	48"	28 Lbs.	1 Cu.Ft	\$ 400	NOTES: *End Panels do not include any hardware. *When ordering panels exact dimensions must be specified, nominal dimensions are inadequate. *3/4" thick panels are for wall mount applications and 1" thick panels are for steel shelving mount applications. *High pressure plastic laminate both faces with 1/4" thick external solid band edge
	EP-SWU-4824		24"	3/4"	48"	28 Lbs.	1 Cu.Ft	\$ 469	
	EP-SWU-4828		28"	3/4"	48"	28 Lbs.	1 Cu.Ft	\$ 538	
	EP-SWU-4830		30"	3/4"	48"	28 Lbs.	1 Cu.Ft	\$ 575	
	EP-SWU-6620	Double Face, 66" Height	20"	3/4"	66"	32 Lbs.	1 Cu.Ft	\$ 488	
	EP-SWU-6624		24"	3/4"	66"	32 Lbs.	2 Cu.Ft	\$ 563	
	EP-SWU-6628		28"	3/4"	66"	32 Lbs.	2 Cu.Ft	\$ 650	
	EP-SWU-6630		30"	3/4"	66"	32 Lbs.	2 Cu.Ft	\$ 688	
	EP-SWU-7820	Double Face, 78" Height	20"	3/4"	78"	40 Lbs.	2 Cu.Ft	\$ 613	
	EP-SWU-7824		24"	3/4"	78"	40 Lbs.	2 Cu.Ft	\$ 731	
	EP-SWU-7828		28"	3/4"	78"	40 Lbs.	2 Cu.Ft	\$ 831	
	EP-SWU-7830		30"	3/4"	78"	40 Lbs.	2 Cu.Ft	\$ 888	
	EP-SWU-9620	Double Face, 96" Height	20"	3/4"	96"	40 Lbs.	2 Cu.Ft	\$ 700	
	EP-SWU-9624		24"	3/4"	96"	40 Lbs.	2 Cu.Ft	\$ 819	
	EP-SWU-9628		28"	3/4"	96"	40 Lbs.	2 Cu.Ft	\$ 944	
	EP-SWU-9630		30"	3/4"	96"	40 Lbs.	2 Cu.Ft	\$ 1,006	
	EP-SWU-4820PX	Double Face, 48" Height	20"	3/4"	48"	28 Lbs.	1 Cu.Ft	\$ 419	
	EP-SWU-4824PX	Laminate, Wood Edge	24"	3/4"	48"	28 Lbs.	1 Cu.Ft	\$ 488	
EP-SWU-4828PX		28"	3/4"	48"	28 Lbs.	1 Cu.Ft	\$ 563		
EP-SWU-4830PX		30"	3/4"	48"	28 Lbs.	1 Cu.Ft	\$ 600		
EP-SWU-6620PX	Double Face, 66" Height	20"	3/4"	66"	32 Lbs.	1 Cu.Ft	\$ 506		
EP-SWU-6624PX	Laminate, Wood Edge	24"	3/4"	66"	32 Lbs.	2 Cu.Ft	\$ 594		
EP-SWU-6628PX		28"	3/4"	66"	32 Lbs.	2 Cu.Ft	\$ 681		
EP-SWU-6630PX		30"	3/4"	66"	32 Lbs.	2 Cu.Ft	\$ 719		
EP-SWU-7820PX	Double Face, 78" Height	20"	3/4"	78"	40 Lbs.	2 Cu.Ft	\$ 644		
EP-SWU-7824PX	Laminate, Wood Edge	24"	3/4"	78"	40 Lbs.	2 Cu.Ft	\$ 756		
EP-SWU-7828PX		28"	3/4"	78"	40 Lbs.	2 Cu.Ft	\$ 869		
EP-SWU-7830PX		30"	3/4"	78"	40 Lbs.	2 Cu.Ft	\$ 925		
EP-SWU-9620PX	Double Face, 96" Height	20"	3/4"	96"	40 Lbs.	2 Cu.Ft	\$ 731		
EP-SWU-9624PX	Laminate, Wood Edge	24"	3/4"	96"	40 Lbs.	2 Cu.Ft	\$ 856		
EP-SWU-9628PX		28"	3/4"	96"	40 Lbs.	2 Cu.Ft	\$ 981		
EP-SWU-9630PX		30"	3/4"	96"	40 Lbs.	2 Cu.Ft	\$ 1,050		

MODEL NUMBER	PRODUCT	WIDTH	DEPTH	HEIGHT	WEIGHT	VOLUME	PRICE	DESCRIPTION
	Slatwall, Black Plastic Insert - End Panel:							PANEL CONSTRUCTION:
								Panels constructed from 3/4" thick 3-ply medium density fiberboard with grade "A" select veneers both faces. All edges banded with 1/4" thick solid external banding. All edges will be eased. Grooved slots include black plastic channel inserts.
								NOTES:
								*End Panels do not include any hardware.
								*When ordering panels exact dimensions must be specified, nominal dimensions are inadequate.
								*3/4" thick panels are for wall mount applications and 1" thick panels are for steel shelving mount applications.
								*High pressure plastic laminate both faces with 1/4" thick external solid band edge
	EP-SWP-4810 Single Face, 48" Height	10"	3/4"	48"	14 Lbs.	1 Cu.Ft	\$ 256	
	EP-SWP-4812	12"	3/4"	48"	14 Lbs.	1 Cu.Ft	\$ 294	
	EP-SWP-4814	14"	3/4"	48"	14 Lbs.	1 Cu.Ft	\$ 331	
	EP-SWP-6610 Single Face, 66" Height	10"	3/4"	66"	16 Lbs.	1 Cu.Ft	\$ 313	
	EP-SWP-6612	12"	3/4"	66"	16 Lbs.	1 Cu.Ft	\$ 363	
	EP-SWP-6614	14"	3/4"	66"	16 Lbs.	1 Cu.Ft	\$ 413	
	EP-SWP-7810 Single Face, 78" Height	10"	3/4"	78"	20 Lbs.	1 Cu.Ft	\$ 375	
	EP-SWP-7812	12"	3/4"	78"	20 Lbs.	1 Cu.Ft	\$ 438	
	EP-SWP-7814	14"	3/4"	78"	20 Lbs.	1 Cu.Ft	\$ 513	
	EP-SWP-9610 Single Face, 96" Height	10"	3/4"	96"	20 Lbs.	1 Cu.Ft	\$ 431	
	EP-SWP-9612	12"	3/4"	96"	20 Lbs.	1 Cu.Ft	\$ 506	
	EP-SWP-9614	14"	3/4"	96"	20 Lbs.	1 Cu.Ft	\$ 581	
	EP-SWP-4810PX Single Face, 48" Height Laminate, Wood Edge	10"	3/4"	48"	14 Lbs.	1 Cu.Ft	\$ 269	
	EP-SWP-4812PX	12"	3/4"	48"	14 Lbs.	1 Cu.Ft	\$ 306	
	EP-SWP-4814PX	14"	3/4"	48"	14 Lbs.	1 Cu.Ft	\$ 344	
	EP-SWP-6610PX Single Face, 66" Height Laminate, Wood Edge	10"	3/4"	66"	16 Lbs.	1 Cu.Ft	\$ 325	
	EP-SWP-6612PX	12"	3/4"	66"	16 Lbs.	1 Cu.Ft	\$ 381	
	EP-SWP-6614PX	14"	3/4"	66"	16 Lbs.	1 Cu.Ft	\$ 431	
	EP-SWP-7810PX Single Face, 78" Height Laminate, Wood Edge	10"	3/4"	78"	20 Lbs.	1 Cu.Ft	\$ 394	
	EP-SWP-7812PX	12"	3/4"	78"	20 Lbs.	1 Cu.Ft	\$ 456	
	EP-SWP-7814PX	14"	3/4"	78"	20 Lbs.	1 Cu.Ft	\$ 531	
	EP-SWP-9610PX Single Face, 96" Height Laminate, Wood Edge	10"	3/4"	96"	20 Lbs.	1 Cu.Ft	\$ 450	
	EP-SWP-9612PX	12"	3/4"	96"	20 Lbs.	1 Cu.Ft	\$ 525	
	EP-SWP-9614PX	14"	3/4"	96"	20 Lbs.	1 Cu.Ft	\$ 606	

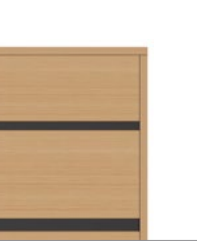
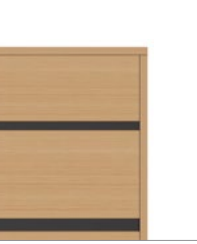
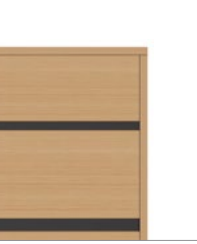
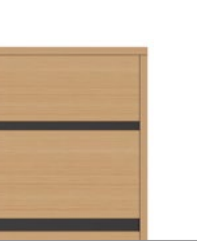
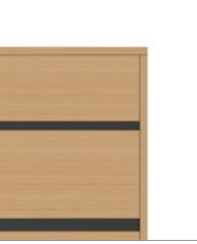
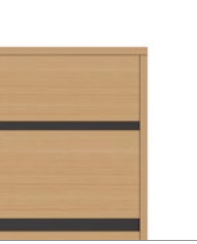
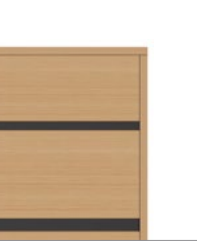
MODEL NUMBER	PRODUCT	WIDTH	DEPTH	HEIGHT	WEIGHT	VOLUME	PRICE	DESCRIPTION
Slatwall, Black Plastic Insert - End Panel:		PANEL CONSTRUCTION:						
	EP-SWP-4820 Double Face, 48" Height	20"	3/4"	48"	28 Lbs.	1 Cu.Ft	\$ 456	Panels constructed from 3/4" thick 3-ply medium density fiberboard with grade "A" select veneers both faces. All edges banded with 1/4" thick solid external banding. All edges will be eased. Grooved slots include black plastic channel inserts.
	EP-SWP-4824	24"	3/4"	48"	28 Lbs.	1 Cu.Ft	\$ 538	
	EP-SWP-4828	28"	3/4"	48"	28 Lbs.	1 Cu.Ft	\$ 619	
	EP-SWP-4830	30"	3/4"	48"	28 Lbs.	1 Cu.Ft	\$ 663	
	EP-SWP-6620 Double Face, 66" Height	20"	3/4"	66"	32 Lbs.	1 Cu.Ft	\$ 569	NOTES: *End Panels do not include any hardware. *When ordering panels exact dimensions must be specified, nominal dimensions are inadequate.
	EP-SWP-6624	24"	3/4"	66"	32 Lbs.	2 Cu.Ft	\$ 663	
	EP-SWP-6628	28"	3/4"	66"	32 Lbs.	2 Cu.Ft	\$ 769	
	EP-SWP-6630	30"	3/4"	66"	32 Lbs.	2 Cu.Ft	\$ 813	
	EP-SWP-7820 Double Face, 78" Height	20"	3/4"	78"	40 Lbs.	2 Cu.Ft	\$ 713	*3/4" thick panels are for wall mount applications and 1" thick panels are for steel shelving mount applications.
	EP-SWP-7824	24"	3/4"	78"	40 Lbs.	2 Cu.Ft	\$ 850	
	EP-SWP-7828	28"	3/4"	78"	40 Lbs.	2 Cu.Ft	\$ 969	
	EP-SWP-7830	30"	3/4"	78"	40 Lbs.	2 Cu.Ft	\$ 1,038	
	EP-SWP-9620 Double Face, 96" Height	20"	3/4"	96"	40 Lbs.	2 Cu.Ft	\$ 825	*High pressure plastic laminate both faces with 1/4" thick external solid band edge
	EP-SWP-9624	24"	3/4"	96"	40 Lbs.	2 Cu.Ft	\$ 969	
	EP-SWP-9628	28"	3/4"	96"	40 Lbs.	2 Cu.Ft	\$ 1,119	
	EP-SWP-9630	30"	3/4"	96"	40 Lbs.	2 Cu.Ft	\$ 1,188	
	EP-SWP-4820PX Double Face, 48" Height	20"	3/4"	48"	28 Lbs.	1 Cu.Ft	\$ 475	
	EP-SWP-4824PX Laminate, Wood Edge	24"	3/4"	48"	28 Lbs.	1 Cu.Ft	\$ 556	
	EP-SWP-4828PX	28"	3/4"	48"	28 Lbs.	1 Cu.Ft	\$ 644	
	EP-SWP-4830PX	30"	3/4"	48"	28 Lbs.	1 Cu.Ft	\$ 688	
	EP-SWP-6620PX Double Face, 66" Height	20"	3/4"	66"	32 Lbs.	1 Cu.Ft	\$ 594	
	EP-SWP-6624PX Laminate, Wood Edge	24"	3/4"	66"	32 Lbs.	2 Cu.Ft	\$ 694	
	EP-SWP-6628PX	28"	3/4"	66"	32 Lbs.	2 Cu.Ft	\$ 794	
	EP-SWP-6630PX	30"	3/4"	66"	32 Lbs.	2 Cu.Ft	\$ 844	
	EP-SWP-7820PX Double Face, 78" Height	20"	3/4"	78"	40 Lbs.	2 Cu.Ft	\$ 744	
	EP-SWP-7824PX Laminate, Wood Edge	24"	3/4"	78"	40 Lbs.	2 Cu.Ft	\$ 875	
	EP-SWP-7828PX	28"	3/4"	78"	40 Lbs.	2 Cu.Ft	\$ 1,006	
	EP-SWP-7830PX	30"	3/4"	78"	40 Lbs.	2 Cu.Ft	\$ 1,075	
	EP-SWP-9620PX Double Face, 96" Height	20"	3/4"	96"	40 Lbs.	2 Cu.Ft	\$ 856	
	EP-SWP-9624PX Laminate, Wood Edge	24"	3/4"	96"	40 Lbs.	2 Cu.Ft	\$ 1,006	
	EP-SWP-9628PX	28"	3/4"	96"	40 Lbs.	2 Cu.Ft	\$ 1,156	
	EP-SWP-9630PX	30"	3/4"	96"	40 Lbs.	2 Cu.Ft	\$ 1,238	

MODEL NUMBER	PRODUCT	WIDTH	DEPTH	HEIGHT	WEIGHT	VOLUME	PRICE	DESCRIPTION
	Slatwall, Extruded Aluminum Insert - End Panel:							PANEL CONSTRUCTION:
EP-SWA-4820	Double Face, 48" Height	20"	3/4"	48"	28 Lbs.	1 Cu.Ft	\$ 519	Panels constructed from 3/4" thick 3-ply medium density fiberboard with grade "A" select veneers both faces. All edges banded with 1/4" thick solid external banding. All edges will be eased. Grooved slots include extruded aluminum channel inserts.
EP-SWA-4824		24"	3/4"	48"	28 Lbs.	1 Cu.Ft	\$ 613	
EP-SWA-4828		28"	3/4"	48"	28 Lbs.	1 Cu.Ft	\$ 706	
EP-SWA-4830		30"	3/4"	48"	28 Lbs.	1 Cu.Ft	\$ 750	
EP-SWA-6620	Double Face, 66" Height	20"	3/4"	66"	32 Lbs.	1 Cu.Ft	\$ 650	NOTES: *End Panels do not include any hardware. *When ordering panels exact dimensions must be specified, nominal dimensions are inadequate. *3/4" thick panels are for wall mount applications and 1" thick panels are for steel shelving mount applications. *High pressure plastic laminate both faces with 1/4" thick external solid band edge
EP-SWA-6624		24"	3/4"	66"	32 Lbs.	2 Cu.Ft	\$ 763	
EP-SWA-6628		28"	3/4"	66"	32 Lbs.	2 Cu.Ft	\$ 881	
EP-SWA-6630		30"	3/4"	66"	32 Lbs.	2 Cu.Ft	\$ 938	
EP-SWA-7820	Double Face, 78" Height	20"	3/4"	78"	40 Lbs.	2 Cu.Ft	\$ 813	
EP-SWA-7824		24"	3/4"	78"	40 Lbs.	2 Cu.Ft	\$ 969	
EP-SWA-7828		28"	3/4"	78"	40 Lbs.	2 Cu.Ft	\$ 1,106	
EP-SWA-7830		30"	3/4"	78"	40 Lbs.	2 Cu.Ft	\$ 1,188	
EP-SWA-9620	Double Face, 96" Height	20"	3/4"	96"	40 Lbs.	2 Cu.Ft	\$ 944	
EP-SWA-9624		24"	3/4"	96"	40 Lbs.	2 Cu.Ft	\$ 1,113	
EP-SWA-9628		28"	3/4"	96"	40 Lbs.	2 Cu.Ft	\$ 1,288	
EP-SWA-9630		30"	3/4"	96"	40 Lbs.	2 Cu.Ft	\$ 1,375	
EP-SWA-4820PX	Double Face, 48" Height	20"	3/4"	48"	28 Lbs.	1 Cu.Ft	\$ 538	
EP-SWA-4824PX	Laminate, Wood Edge	24"	3/4"	48"	28 Lbs.	1 Cu.Ft	\$ 631	
EP-SWA-4828PX		28"	3/4"	48"	28 Lbs.	1 Cu.Ft	\$ 725	
EP-SWA-4830PX		30"	3/4"	48"	28 Lbs.	1 Cu.Ft	\$ 781	
EP-SWA-6620PX	Double Face, 66" Height	20"	3/4"	66"	32 Lbs.	1 Cu.Ft	\$ 675	
EP-SWA-6624PX	Laminate, Wood Edge	24"	3/4"	66"	32 Lbs.	2 Cu.Ft	\$ 794	
EP-SWA-6628PX		28"	3/4"	66"	32 Lbs.	2 Cu.Ft	\$ 913	
EP-SWA-6630PX		30"	3/4"	66"	32 Lbs.	2 Cu.Ft	\$ 969	
EP-SWA-7820PX	Double Face, 78" Height	20"	3/4"	78"	40 Lbs.	2 Cu.Ft	\$ 844	
EP-SWA-7824PX	Laminate, Wood Edge	24"	3/4"	78"	40 Lbs.	2 Cu.Ft	\$ 994	
EP-SWA-7828PX		28"	3/4"	78"	40 Lbs.	2 Cu.Ft	\$ 1,144	
EP-SWA-7830PX		30"	3/4"	78"	40 Lbs.	2 Cu.Ft	\$ 1,225	
EP-SWA-9620PX	Double Face, 96" Height	20"	3/4"	96"	40 Lbs.	2 Cu.Ft	\$ 981	
EP-SWA-9624PX	Laminate, Wood Edge	24"	3/4"	96"	40 Lbs.	2 Cu.Ft	\$ 1,150	
EP-SWA-9628PX		28"	3/4"	96"	40 Lbs.	2 Cu.Ft	\$ 1,325	
EP-SWA-9630PX		30"	3/4"	96"	40 Lbs.	2 Cu.Ft	\$ 1,419	

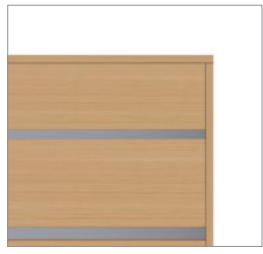

MODEL NUMBER	PRODUCT	WIDTH	DEPTH	HEIGHT	WEIGHT	VOLUME	PRICE	DESCRIPTION
	Slatwall 1", Unfinished Insert - End Panel:							PANEL CONSTRUCTION:
EP-SWU1-4810	Single Face, 48" Height	10"	1"	48"	14 Lbs.	1 Cu.Ft	\$ 313	Panels constructed from 1" thick 3-ply medium density fiberboard with grade "A" select veneers both faces. All edges banded with 1/4" thick solid external banding. All edges will be eased. Grooved slots are unfinished.
EP-SWU1-4812		12"	1"	48"	14 Lbs.	1 Cu.Ft	\$ 363	
EP-SWU1-4814		14"	1"	48"	14 Lbs.	1 Cu.Ft	\$ 406	
EP-SWU1-6610	Single Face, 66" Height	10"	1"	66"	16 Lbs.	1 Cu.Ft	\$ 375	NOTES: *End Panels do not include any hardware.
EP-SWU1-6612		12"	1"	66"	16 Lbs.	1 Cu.Ft	\$ 431	
EP-SWU1-6614		14"	1"	66"	16 Lbs.	1 Cu.Ft	\$ 481	
EP-SWU1-7810	Single Face, 78" Height	10"	1"	78"	20 Lbs.	1 Cu.Ft	\$ 469	*When ordering panels exact dimensions must be specified, nominal dimensions are inadequate.
EP-SWU1-7812		12"	1"	78"	20 Lbs.	1 Cu.Ft	\$ 538	
EP-SWU1-7814		14"	1"	78"	20 Lbs.	1 Cu.Ft	\$ 613	
EP-SWU1-9610	Single Face, 96" Height	10"	1"	96"	20 Lbs.	1 Cu.Ft	\$ 519	*3/4" thick panels are for wall mount applications and 1" thick panels are for steel shelving mount applications.
EP-SWU1-9612		12"	1"	96"	20 Lbs.	1 Cu.Ft	\$ 606	
EP-SWU1-9614		14"	1"	96"	20 Lbs.	1 Cu.Ft	\$ 700	
EP-SWU1-4810PX	Single Face, 48" Height	10"	1"	48"	14 Lbs.	1 Cu.Ft	\$ 338	*High pressure plastic laminate both faces with 1/4" thick external solid band edge
EP-SWU1-4812PX	Laminate, Wood Edge	12"	1"	48"	14 Lbs.	1 Cu.Ft	\$ 394	
EP-SWU1-4814PX		14"	1"	48"	14 Lbs.	1 Cu.Ft	\$ 438	
EP-SWU1-6610PX	Single Face, 66" Height	10"	1"	66"	16 Lbs.	1 Cu.Ft	\$ 406	
EP-SWU1-6612PX	Laminate, Wood Edge	12"	1"	66"	16 Lbs.	1 Cu.Ft	\$ 463	
EP-SWU1-6614PX		14"	1"	66"	16 Lbs.	1 Cu.Ft	\$ 525	
EP-SWU1-7810PX	Single Face, 78" Height	10"	1"	78"	20 Lbs.	1 Cu.Ft	\$ 506	
EP-SWU1-7812PX	Laminate, Wood Edge	12"	1"	78"	20 Lbs.	1 Cu.Ft	\$ 575	
EP-SWU1-7814PX		14"	1"	78"	20 Lbs.	1 Cu.Ft	\$ 663	
EP-SWU1-9610PX	Single Face, 96" Height	10"	1"	96"	20 Lbs.	1 Cu.Ft	\$ 556	
EP-SWU1-9612PX	Laminate, Wood Edge	12"	1"	96"	20 Lbs.	1 Cu.Ft	\$ 650	
EP-SWU1-9614PX		14"	1"	96"	20 Lbs.	1 Cu.Ft	\$ 744	

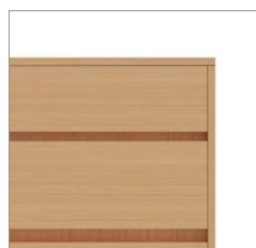

MODEL NUMBER	PRODUCT	WIDTH	DEPTH	HEIGHT	WEIGHT	VOLUME	PRICE	DESCRIPTION
	Slatwall 1", Unfinished Insert - End Panel:							PANEL CONSTRUCTION:
EP-SWU1-4820	Double Face, 48" Height	20"	1"	48"	28 Lbs.	1 Cu.Ft	\$ 538	Panels constructed from 1" thick 3-ply medium density fiberboard with grade "A" select veneers both faces. All edges banded with 1/4" thick solid external banding. All edges will be eased. Grooved slots are unfinished.
EP-SWU1-4824		24"	1"	48"	28 Lbs.	1 Cu.Ft	\$ 631	
EP-SWU1-4828		28"	1"	48"	28 Lbs.	1 Cu.Ft	\$ 725	
EP-SWU1-4830		30"	1"	48"	28 Lbs.	1 Cu.Ft	\$ 769	
EP-SWU1-6620	Double Face, 66" Height	20"	1"	66"	32 Lbs.	1 Cu.Ft	\$ 644	NOTES: *End Panels do not include any hardware. *When ordering panels exact dimensions must be specified, nominal dimensions are inadequate.
EP-SWU1-6624		24"	1"	66"	32 Lbs.	2 Cu.Ft	\$ 763	
EP-SWU1-6628		28"	1"	66"	32 Lbs.	2 Cu.Ft	\$ 869	
EP-SWU1-6630		30"	1"	66"	32 Lbs.	2 Cu.Ft	\$ 925	
EP-SWU1-7820	Double Face, 78" Height	20"	1"	78"	40 Lbs.	2 Cu.Ft	\$ 738	*3/4" thick panels are for wall mount applications and 1" thick panels are for steel shelving mount applications.
EP-SWU1-7824		24"	1"	78"	40 Lbs.	2 Cu.Ft	\$ 875	
EP-SWU1-7828		28"	1"	78"	40 Lbs.	2 Cu.Ft	\$ 994	
EP-SWU1-7830		30"	1"	78"	40 Lbs.	2 Cu.Ft	\$ 1,063	
EP-SWU1-9620	Double Face, 96" Height	20"	1"	96"	40 Lbs.	2 Cu.Ft	\$ 838	*High pressure plastic laminate both faces with 1/4" thick external solid band edge
EP-SWU1-9624		24"	1"	96"	40 Lbs.	2 Cu.Ft	\$ 981	
EP-SWU1-9628		28"	1"	96"	40 Lbs.	2 Cu.Ft	\$ 1,131	
EP-SWU1-9630		30"	1"	96"	40 Lbs.	2 Cu.Ft	\$ 1,206	
EP-SWU1-4820PX	Double Face, 48" Height	20"	1"	48"	28 Lbs.	1 Cu.Ft	\$ 581	
EP-SWU1-4824PX	Laminate, Wood Edge	24"	1"	48"	28 Lbs.	1 Cu.Ft	\$ 681	
EP-SWU1-4828PX		28"	1"	48"	28 Lbs.	1 Cu.Ft	\$ 781	
EP-SWU1-4830PX		30"	1"	48"	28 Lbs.	1 Cu.Ft	\$ 831	
EP-SWU1-6620PX	Double Face, 66" Height	20"	1"	66"	32 Lbs.	1 Cu.Ft	\$ 700	
EP-SWU1-6624PX	Laminate, Wood Edge	24"	1"	66"	32 Lbs.	2 Cu.Ft	\$ 819	
EP-SWU1-6628PX		28"	1"	66"	32 Lbs.	2 Cu.Ft	\$ 931	
EP-SWU1-6630PX		30"	1"	66"	32 Lbs.	2 Cu.Ft	\$ 1,000	
EP-SWU1-7820PX	Double Face, 78" Height	20"	1"	78"	40 Lbs.	2 Cu.Ft	\$ 794	
EP-SWU1-7824PX	Laminate, Wood Edge	24"	1"	78"	40 Lbs.	2 Cu.Ft	\$ 931	
EP-SWU1-7828PX		28"	1"	78"	40 Lbs.	2 Cu.Ft	\$ 1,075	
EP-SWU1-7830PX		30"	1"	78"	40 Lbs.	2 Cu.Ft	\$ 1,144	
EP-SWU1-9620PX	Double Face, 96" Height	20"	1"	96"	40 Lbs.	2 Cu.Ft	\$ 906	
EP-SWU1-9624PX	Laminate, Wood Edge	24"	1"	96"	40 Lbs.	2 Cu.Ft	\$ 1,050	
EP-SWU1-9628PX		28"	1"	96"	40 Lbs.	2 Cu.Ft	\$ 1,213	
EP-SWU1-9630PX		30"	1"	96"	40 Lbs.	2 Cu.Ft	\$ 1,300	



MODEL NUMBER	PRODUCT	WIDTH	DEPTH	HEIGHT	WEIGHT	VOLUME	PRICE	DESCRIPTION
	Slatwall 1", Black Plastic Insert - End Panel:							PANEL CONSTRUCTION:
EP-SWP1-4810	Single Face, 48" Height	10"	1"	48"	14 Lbs.	1 Cu.Ft	\$ 344	Panels constructed from 1" thick 3-ply medium density fiberboard with grade "A" select veneers both faces. All edges banded with 1/4" thick solid external banding. All edges will be eased. Grooved slots include black plastic channel inserts.
EP-SWP1-4812		12"	1"	48"	14 Lbs.	1 Cu.Ft	\$ 400	
EP-SWP1-4814		14"	1"	48"	14 Lbs.	1 Cu.Ft	\$ 450	
EP-SWP1-6610	Single Face, 66" Height	10"	1"	66"	16 Lbs.	1 Cu.Ft	\$ 419	NOTES: *End Panels do not include any hardware.
EP-SWP1-6612		12"	1"	66"	16 Lbs.	1 Cu.Ft	\$ 475	
EP-SWP1-6614		14"	1"	66"	16 Lbs.	1 Cu.Ft	\$ 544	
EP-SWP1-7810	Single Face, 78" Height	10"	1"	78"	20 Lbs.	1 Cu.Ft	\$ 513	*When ordering panels exact dimensions must be specified, nominal dimensions are inadequate.
EP-SWP1-7812		12"	1"	78"	20 Lbs.	1 Cu.Ft	\$ 594	
EP-SWP1-7814		14"	1"	78"	20 Lbs.	1 Cu.Ft	\$ 681	
EP-SWP1-9610	Single Face, 96" Height	10"	1"	96"	20 Lbs.	1 Cu.Ft	\$ 575	*3/4" thick panels are for wall mount applications and 1" thick panels are for steel shelving mount applications. *High pressure plastic laminate both faces with 1/4" thick external solid band edge
EP-SWP1-9612		12"	1"	96"	20 Lbs.	1 Cu.Ft	\$ 681	
EP-SWP1-9614		14"	1"	96"	20 Lbs.	1 Cu.Ft	\$ 781	
EP-SWP1-4810PX	Single Face, 48" Height	10"	1"	48"	14 Lbs.	1 Cu.Ft	\$ 369	
EP-SWP1-4812PX	Laminate, Wood Edge	12"	1"	48"	14 Lbs.	1 Cu.Ft	\$ 431	
EP-SWP1-4814PX		14"	1"	48"	14 Lbs.	1 Cu.Ft	\$ 481	
EP-SWP1-6610PX	Single Face, 66" Height	10"	1"	66"	16 Lbs.	1 Cu.Ft	\$ 450	
EP-SWP1-6612PX	Laminate, Wood Edge	12"	1"	66"	16 Lbs.	1 Cu.Ft	\$ 513	
EP-SWP1-6614PX		14"	1"	66"	16 Lbs.	1 Cu.Ft	\$ 581	
EP-SWP1-7810PX	Single Face, 78" Height	10"	1"	78"	20 Lbs.	1 Cu.Ft	\$ 556	
EP-SWP1-7812PX	Laminate, Wood Edge	12"	1"	78"	20 Lbs.	1 Cu.Ft	\$ 638	
EP-SWP1-7814PX		14"	1"	78"	20 Lbs.	1 Cu.Ft	\$ 731	
EP-SWP1-9610PX	Single Face, 96" Height	10"	1"	96"	20 Lbs.	1 Cu.Ft	\$ 613	
EP-SWP1-9612PX	Laminate, Wood Edge	12"	1"	96"	20 Lbs.	1 Cu.Ft	\$ 725	
EP-SWP1-9614PX		14"	1"	96"	20 Lbs.	1 Cu.Ft	\$ 831	

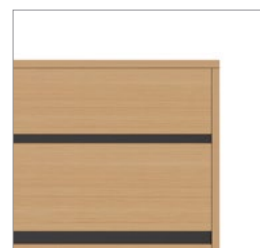

MODEL NUMBER	PRODUCT	WIDTH	DEPTH	HEIGHT	WEIGHT	VOLUME	PRICE	DESCRIPTION
	Slatwall 1", Black Plastic Insert - End Panel:							PANEL CONSTRUCTION:
EP-SWP1-4820	Double Face, 48" Height	20"	1"	48"	28 Lbs.	1 Cu.Ft	\$ 594	Panels constructed from 1" thick 3-ply medium density fiberboard with grade "A" select veneers both faces. All edges banded with 1/4" thick solid external banding. All edges will be eased. Grooved slots include black plastic channel inserts.
EP-SWP1-4824		24"	1"	48"	28 Lbs.	1 Cu.Ft	\$ 700	
EP-SWP1-4828		28"	1"	48"	28 Lbs.	1 Cu.Ft	\$ 806	
EP-SWP1-4830		30"	1"	48"	28 Lbs.	1 Cu.Ft	\$ 863	
EP-SWP1-6620	Double Face, 66" Height	20"	1"	66"	32 Lbs.	1 Cu.Ft	\$ 731	NOTES: *End Panels do not include any hardware. *When ordering panels exact dimensions must be specified, nominal dimensions are inadequate.
EP-SWP1-6624		24"	1"	66"	32 Lbs.	2 Cu.Ft	\$ 863	
EP-SWP1-6628		28"	1"	66"	32 Lbs.	2 Cu.Ft	\$ 988	
EP-SWP1-6630		30"	1"	66"	32 Lbs.	2 Cu.Ft	\$ 1,050	
EP-SWP1-7820	Double Face, 78" Height	20"	1"	78"	40 Lbs.	2 Cu.Ft	\$ 838	*3/4" thick panels are for wall mount applications and 1" thick panels are for steel shelving mount applications. *High pressure plastic laminate both faces with 1/4" thick external solid band edge
EP-SWP1-7824		24"	1"	78"	40 Lbs.	2 Cu.Ft	\$ 994	
EP-SWP1-7828		28"	1"	78"	40 Lbs.	2 Cu.Ft	\$ 1,138	
EP-SWP1-7830		30"	1"	78"	40 Lbs.	2 Cu.Ft	\$ 1,213	
EP-SWP1-9620	Double Face, 96" Height	20"	1"	96"	40 Lbs.	2 Cu.Ft	\$ 963	
EP-SWP1-9624		24"	1"	96"	40 Lbs.	2 Cu.Ft	\$ 1,131	
EP-SWP1-9628		28"	1"	96"	40 Lbs.	2 Cu.Ft	\$ 1,300	
EP-SWP1-9630		30"	1"	96"	40 Lbs.	2 Cu.Ft	\$ 1,388	
EP-SWP1-4820PX	Double Face, 48" Height	20"	1"	48"	28 Lbs.	1 Cu.Ft	\$ 638	
EP-SWP1-4824PX	Laminate, Wood Edge	24"	1"	48"	28 Lbs.	1 Cu.Ft	\$ 756	
EP-SWP1-4828PX		28"	1"	48"	28 Lbs.	1 Cu.Ft	\$ 863	
EP-SWP1-4830PX		30"	1"	48"	28 Lbs.	1 Cu.Ft	\$ 919	
EP-SWP1-6620PX	Double Face, 66" Height	20"	1"	66"	32 Lbs.	1 Cu.Ft	\$ 781	
EP-SWP1-6624PX	Laminate, Wood Edge	24"	1"	66"	32 Lbs.	2 Cu.Ft	\$ 919	
EP-SWP1-6628PX		28"	1"	66"	32 Lbs.	2 Cu.Ft	\$ 1,050	
EP-SWP1-6630PX		30"	1"	66"	32 Lbs.	2 Cu.Ft	\$ 1,119	
EP-SWP1-7820PX	Double Face, 78" Height	20"	1"	78"	40 Lbs.	2 Cu.Ft	\$ 894	
EP-SWP1-7824PX	Laminate, Wood Edge	24"	1"	78"	40 Lbs.	2 Cu.Ft	\$ 1,050	
EP-SWP1-7828PX		28"	1"	78"	40 Lbs.	2 Cu.Ft	\$ 1,213	
EP-SWP1-7830PX		30"	1"	78"	40 Lbs.	2 Cu.Ft	\$ 1,294	
EP-SWP1-9620PX	Double Face, 96" Height	20"	1"	96"	40 Lbs.	2 Cu.Ft	\$ 1,025	
EP-SWP1-9624PX	Laminate, Wood Edge	24"	1"	96"	40 Lbs.	2 Cu.Ft	\$ 1,200	
EP-SWP1-9628PX		28"	1"	96"	40 Lbs.	2 Cu.Ft	\$ 1,388	
EP-SWP1-9630PX		30"	1"	96"	40 Lbs.	2 Cu.Ft	\$ 1,481	

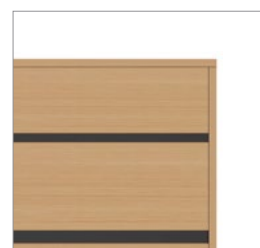

MODEL NUMBER	PRODUCT	WIDTH	DEPTH	HEIGHT	WEIGHT	VOLUME	PRICE	DESCRIPTION
	Slatwall 1", Extruded Aluminum Insert - End Panel:							PANEL CONSTRUCTION:
EP-SWA1-4810	Single Face, 48" Height	10"	1"	48"	14 Lbs.	1 Cu.Ft	\$ 375	Panels constructed from 1" thick 3-ply medium density fiberboard with grade "A" select veneers both faces. All edges banded with 1/4" thick solid external banding. All edges will be eased. Grooved slots include extruded aluminum channel inserts.
EP-SWA1-4812		12"	1"	48"	14 Lbs.	1 Cu.Ft	\$ 431	
EP-SWA1-4814		14"	1"	48"	14 Lbs.	1 Cu.Ft	\$ 488	
EP-SWA1-6610	Single Face, 66" Height	10"	1"	66"	16 Lbs.	1 Cu.Ft	\$ 463	
EP-SWA1-6612		12"	1"	66"	16 Lbs.	1 Cu.Ft	\$ 525	
EP-SWA1-6614		14"	1"	66"	16 Lbs.	1 Cu.Ft	\$ 600	
EP-SWA1-7810	Single Face, 78" Height	10"	1"	78"	20 Lbs.	1 Cu.Ft	\$ 563	
EP-SWA1-7812		12"	1"	78"	20 Lbs.	1 Cu.Ft	\$ 656	
EP-SWA1-7814		14"	1"	78"	20 Lbs.	1 Cu.Ft	\$ 756	
EP-SWA1-9610	Single Face, 96" Height	10"	1"	96"	20 Lbs.	1 Cu.Ft	\$ 663	
EP-SWA1-9612		12"	1"	96"	20 Lbs.	1 Cu.Ft	\$ 756	
EP-SWA1-9614		14"	1"	96"	20 Lbs.	1 Cu.Ft	\$ 869	
EP-SWA1-4810PX	Single Face, 48" Height	10"	1"	48"	14 Lbs.	1 Cu.Ft	\$ 394	NOTES: *End Panels do not include any hardware. *When ordering panels exact dimensions must be specified, nominal dimensions are inadequate. *3/4" thick panels are for wall mount applications and 1" thick panels are for steel shelving mount applications. *High pressure plastic laminate both faces with 1/4" thick external solid band edge
EP-SWA1-4812PX	Laminate, Wood Edge	12"	1"	48"	14 Lbs.	1 Cu.Ft	\$ 469	
EP-SWA1-4814PX		14"	1"	48"	14 Lbs.	1 Cu.Ft	\$ 525	
EP-SWA1-6610PX	Single Face, 66" Height	10"	1"	66"	16 Lbs.	1 Cu.Ft	\$ 488	
EP-SWA1-6612PX	Laminate, Wood Edge	12"	1"	66"	16 Lbs.	1 Cu.Ft	\$ 563	
EP-SWA1-6614PX		14"	1"	66"	16 Lbs.	1 Cu.Ft	\$ 638	
EP-SWA1-7810PX	Single Face, 78" Height	10"	1"	78"	20 Lbs.	1 Cu.Ft	\$ 600	
EP-SWA1-7812PX	Laminate, Wood Edge	12"	1"	78"	20 Lbs.	1 Cu.Ft	\$ 694	
EP-SWA1-7814PX		14"	1"	78"	20 Lbs.	1 Cu.Ft	\$ 800	
EP-SWA1-9610PX	Single Face, 96" Height	10"	1"	96"	20 Lbs.	1 Cu.Ft	\$ 700	
EP-SWA1-9612PX	Laminate, Wood Edge	12"	1"	96"	20 Lbs.	1 Cu.Ft	\$ 800	
EP-SWA1-9614PX		14"	1"	96"	20 Lbs.	1 Cu.Ft	\$ 919	

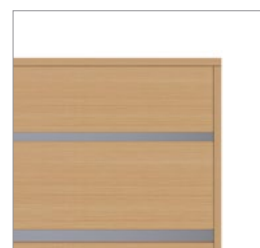

MODEL NUMBER	PRODUCT	WIDTH	DEPTH	HEIGHT	WEIGHT	VOLUME	PRICE	DESCRIPTION
	Slatwall 1", Extruded Aluminum Insert - End Panel:							PANEL CONSTRUCTION:
EP-SWA1-4820	Double Face, 48" Height	20"	1"	48"	28 Lbs.	1 Cu.Ft	\$ 656	Panels constructed from 1" thick 3-ply medium density fiberboard with grade "A" select veneers both faces. All edges banded with 1/4" thick solid external banding. All edges will be eased. Grooved slots include extruded aluminum channel inserts.
EP-SWA1-4824		24"	1"	48"	28 Lbs.	1 Cu.Ft	\$ 775	
EP-SWA1-4828		28"	1"	48"	28 Lbs.	1 Cu.Ft	\$ 888	
EP-SWA1-4830		30"	1"	48"	28 Lbs.	1 Cu.Ft	\$ 950	
EP-SWA1-6620	Double Face, 66" Height	20"	1"	66"	32 Lbs.	1 Cu.Ft	\$ 813	NOTES: *End Panels do not include any hardware. *When ordering panels exact dimensions must be specified, nominal dimensions are inadequate. *3/4" thick panels are for wall mount applications and 1" thick panels are for steel shelving mount applications. *High pressure plastic laminate both faces with 1/4" thick external solid band edge
EP-SWA1-6624		24"	1"	66"	32 Lbs.	2 Cu.Ft	\$ 963	
EP-SWA1-6628		28"	1"	66"	32 Lbs.	2 Cu.Ft	\$ 1,100	
EP-SWA1-6630		30"	1"	66"	32 Lbs.	2 Cu.Ft	\$ 1,175	
EP-SWA1-7820	Double Face, 78" Height	20"	1"	78"	40 Lbs.	2 Cu.Ft	\$ 938	
EP-SWA1-7824		24"	1"	78"	40 Lbs.	2 Cu.Ft	\$ 1,113	
EP-SWA1-7828		28"	1"	78"	40 Lbs.	2 Cu.Ft	\$ 1,275	
EP-SWA1-7830		30"	1"	78"	40 Lbs.	2 Cu.Ft	\$ 1,363	
EP-SWA1-9620	Double Face, 96" Height	20"	1"	96"	40 Lbs.	2 Cu.Ft	\$ 1,081	
EP-SWA1-9624		24"	1"	96"	40 Lbs.	2 Cu.Ft	\$ 1,275	
EP-SWA1-9628		28"	1"	96"	40 Lbs.	2 Cu.Ft	\$ 1,475	
EP-SWA1-9630		30"	1"	96"	40 Lbs.	2 Cu.Ft	\$ 1,569	
EP-SWA1-4820PX	Double Face, 48" Height	20"	1"	48"	28 Lbs.	1 Cu.Ft	\$ 700	
EP-SWA1-4824PX	Laminate, Wood Edge	24"	1"	48"	28 Lbs.	1 Cu.Ft	\$ 825	
EP-SWA1-4828PX		28"	1"	48"	28 Lbs.	1 Cu.Ft	\$ 944	
EP-SWA1-4830PX		30"	1"	48"	28 Lbs.	1 Cu.Ft	\$ 1,006	
EP-SWA1-6620PX	Double Face, 66" Height	20"	1"	66"	32 Lbs.	1 Cu.Ft	\$ 863	
EP-SWA1-6624PX	Laminate, Wood Edge	24"	1"	66"	32 Lbs.	2 Cu.Ft	\$ 1,019	
EP-SWA1-6628PX		28"	1"	66"	32 Lbs.	2 Cu.Ft	\$ 1,163	
EP-SWA1-6630PX		30"	1"	66"	32 Lbs.	2 Cu.Ft	\$ 1,244	
EP-SWA1-7820PX	Double Face, 78" Height	20"	1"	78"	40 Lbs.	2 Cu.Ft	\$ 994	
EP-SWA1-7824PX	Laminate, Wood Edge	24"	1"	78"	40 Lbs.	2 Cu.Ft	\$ 1,169	
EP-SWA1-7828PX		28"	1"	78"	40 Lbs.	2 Cu.Ft	\$ 1,350	
EP-SWA1-7830PX		30"	1"	78"	40 Lbs.	2 Cu.Ft	\$ 1,444	
EP-SWA1-9620PX	Double Face, 96" Height	20"	1"	96"	40 Lbs.	2 Cu.Ft	\$ 1,150	
EP-SWA1-9624PX	Laminate, Wood Edge	24"	1"	96"	40 Lbs.	2 Cu.Ft	\$ 1,350	
EP-SWA1-9628PX		28"	1"	96"	40 Lbs.	2 Cu.Ft	\$ 1,556	
EP-SWA1-9630PX		30"	1"	96"	40 Lbs.	2 Cu.Ft	\$ 1,669	



Palmieri Furniture Limited ("Palmieri") warrants that its products and collections are free from defects in materials and workmanship for the life of the product, except as set forth below. Palmieri Limited Lifetime Warranty is valid from the date of delivery.

Exceptions to the Limited Lifetime Warranty: Seating: two (2) years

Goods sold hereunder are covered by a Limited Lifetime Warranty, free against defects in material and workmanship provided the goods and services are subjected to normal use and service. The applicable warranty period commences from shipping date to Purchaser of any item of the goods, whichever occurs first, or any other warranty period otherwise stipulated in writing by Palmieri under this sale. For components not supplied by Palmieri, the original manufacturer's warranty shall apply to the extent assignable by Palmieri. The obligation under this warranty is limited to the repair or replacement, at Palmieri's option, of defective parts F.O.B. point of shipment provided that prompt notice of any defect is given by Purchaser to Palmieri in writing within the applicable warranty period and that upon the Purchaser's return of the defective parts to Palmieri or, if designated by Palmieri, to the location where the works are made, properly packed and with transportation charges prepaid by Purchaser, an inspection thereof shall reveal to Palmieri's satisfaction that Purchaser's claim is valid under the terms of this warranty. Purchaser shall assume all responsibility and expense for dismantling, removal, re-installation and freight in connection with the foregoing. The same obligations and conditions extend to replacement parts furnished by Palmieri hereunder.

Palmieri does not assume liability for installation, labour or consequential damages. Palmieri makes no warranty other than the one set forth herein. All other warranties, legal, expressed or implied, including but not limited to any expressed or implied warranty of merchantability, of fitness for the intended use thereof or against infringement are hereby expressly excluded. The applicable warranty ceases to be effective if the goods are altered or repaired other than by persons authorized or approved by Palmieri to perform such work. Repairs or replacement deliveries do not interrupt or prolong the term of the warranty. The warranty ceases to be effective if Purchaser fails to handle and use the goods sold hereunder in a safe and reasonable manner and in accordance with any written instructions from the manufacturers.

Warranty Does Not Apply To Product Failure Or Loss Resulting From:

Abuse, misuse or accident, alteration or modification of product by customer or third party, normal wear and tear, improper installation, handling or incorrect use. The substitution of part components or hardware not approved or authorized by Palmieri, acts of God, unauthorized repairs, improper storage, and environmental conditions such as irregular temperature control either inside or outside the environment.

Warranty Provides Exclusive Remedies:

If a product fails under ordinary use as a result of a defect in material or workmanship, Palmieri will: (A) repair, or (B) replace the furniture. The replacement or repair of the Furniture or Seating will be at the discretion of Palmieri. If the defect or workmanship cannot be remedied on site, repairs can be made at the factory. (C) If the product repair or replacement is not commercially practicable or cannot be remade in a timely manner Palmieri will refund the purchase price of the affected product. A product "**Defect**" means: an inadequacy in the materials or workmanship of the product that (A) existed at the time when you received the product from Palmieri or Palmieri authorized Reseller and (B) causes a failure of the product to perform under ordinary use in accordance with the materials and documentation accompanying the product. "**Ordinary Use**" means: use of the product (A) in accordance with all applicable local, state or federal laws, codes and regulations and (B) in accordance with manufacturer recommendations and or instructions in the materials and documentation accompanying the product or through shop drawings. A "**Palmieri Authorized Reseller**" means: any dealer that is legally permitted to conduct business in the jurisdiction where the product is sold and is duly authorized by Palmieri to sell the product.

Warranty work must be approved by authorized personnel of Palmieri Furniture Limited in Richmond Hill, Ontario, Canada.

A copy of the original purchase order must accompany all claims.

Warranty Does Not Cover:

Matching of colours, stains, textures, grains and any other variations in materials. Select and Custom Surfaces and materials are only warranted for their application on the specified product and are not covered by our warranty, except as warranted by the original supplier, for quality, colorfastness, shade variations or abrasion and textiles purchased for Palmieri product.

This limited warranty is the sole remedy for product defect and no other express or implied warranty is provided. Warranty is not transferable and valid only for the original purchaser acquiring a product from Palmieri or a Palmieri authorized reseller for the purchaser's own use and not for resale, remarketing or distribution. Limited Lifetime Warranty (25 years)

GENERAL

The following Terms and Conditions of Quote and Sale shall apply to any sale of goods and services by Palmieri Furniture Limited (hereinafter called "Palmieri"). Purchaser shall be deemed to have full knowledge of the terms and conditions herein and such terms and conditions shall be binding if either the goods and services referred to herein are delivered to and accepted by Purchaser, or if Purchaser does not within five (5) days from the date hereof deliver to Palmieri written objection to said terms and conditions or any part thereof.

In the event of any conflict or inconsistency between the terms and conditions of sale herein and the terms and conditions contained in Purchaser's order or in any other form issued by Purchaser, whether or not any such form has been acknowledged or accepted by Palmieri, Palmieri's terms and conditions herein shall prevail. No waiver, alteration or modification of these terms and conditions shall be binding upon Palmieri unless made in writing and signed by a duly authorized representative of Palmieri.

1. QUOTATIONS / PRODUCT QUOTED

Unless otherwise stated, **Palmieri's quotations shall be null and void unless accepted by Purchaser within thirty (30) days from the date of quotation.** Quotes may be subject to change before order placement, due to increased material costs and or other factors that could impact the final cost of production and our final understanding of the product required. If the items quoted do not reflect the intended product requirements of the customer, Palmieri will not be held responsible for increased costs for those product changes. We reserve the right to edit or re-quote any portion of a previously submitted quotation subject to our final understanding of the product required by the client.

2. PALMIERI DRAWINGS

Palmieri provides drawings for Custom & Standard product we produce to our clients upon request. We consider these drawings to be Private and Confidential and are provided for the sole purpose and use of our clients to understand the product we are providing. The use of these confidential materials is limited to the transaction between the parties and at no point are these confidential materials to be sent to any of our competitors or parties quoting for the same purpose.

A minimum \$85.00 NET Engineering Administrative Fee will apply for Custom Product Drawings

(Note: The first set of Custom product drawings will be free of charge)

A minimum \$120.00 NET Engineering Administrative Fee will apply for all Standard Product Drawings

3. TERMS OF PAYMENT

For authorized customers; Orders at a \$75,000.00 threshold will require a mandatory 25% deposit. Orders over and above \$100,000.00 requires a mandatory (25%) deposit at time of order, a mandatory (25%) deposit prior to product shipment and the balance to be paid within thirty (30) days of date of shipment. Payment not be made to Palmieri when due, Palmieri reserves the right to charge Purchaser with interest on such overdue payments. Interest of 2% per month (24% per annum) is charged on all overdue accounts, unless otherwise specified. The charging of such interest shall not be construed as obligating Palmieri to grant any extension of time in the terms of payment. All goods remain the property of Palmieri, until balance is paid in full to Palmieri.

4. TITLE

Title to the goods or any part thereof shall not pass from Palmieri to Purchaser until all payments due hereunder have been duly made, except as otherwise expressly stipulated herein. The goods shall be and remain personal or moveable property, notwithstanding their mode of attachment to realty or other property. If default is made in any of the payments herein, Purchaser agrees that Palmieri may retain all payments which have been made on account of the purchase price as liquidated damages, and Palmieri shall be free to enter the premises where the goods may be located and remove them as Palmieri's property, without prejudice to Palmieri's right to recover any further expenses or damages Palmieri may suffer by reason of such nonpayment.

5. TAXES

Prices do not include Goods & Services Tax, Provincial or Municipal sales, use, value-added or similar tax. All applicable taxes are extra. Our Harmonized Sales Tax (HST) registration number is R104055066.

6. THE AGREEMENT

An acceptance and official confirmation of Purchasers' order by signing Palmieri's Order Confirmation the Purchaser therefore is accepting terms and conditions as expressed herein Palmieri's Terms and Conditions of Quote and Sale by Palmieri and shall constitute the complete agreement, subject to the terms and conditions of sale herein set forth, and shall supersede all previous quotations, orders or agreements.

7. LEAD TIME / DELIVERY / DELAYS

Lead time is determined only when final material/finish selection and drawing approvals are received by Palmieri from the client. The accuracy of Palmieri's lead times, is created to the best of our ability with the information provided to us. Confirmed lead time is conveyed to the client by means of Order Confirmation. They do not preclude the client from checking the accuracy of your requirement and our Order Confirmation. Any noted discrepancies are to be reported immediately to Palmieri Customer Service Department for correction and re-issue of revised Order Confirmation. By signing and dating the Order Confirmation the client accepts the terms and conditions of quote and sale.

Lead time on our Order Confirmation do not account for delays that could potentially occur for special materials specified by the client that are outside of our standard finishes and materials program that are out of our control

and will affect the lead time on the order. Palmieri will notify the client immediately when these delays occur and adjust the lead time accordingly.

Delivery schedules are approximate and are based on prevailing market conditions applicable respectively at the time of Palmieri's quotation and Palmieri's acceptance of clients' order, if certain portions of an order are completed by the quoted lead time while other portions have experienced delays outside of our control. The client may choose to part ship the order at their discretion and expense. Otherwise the entire order will ship with the delayed portion at a later date. Palmieri may extend delivery schedules or may, at its option, cancel Purchaser's order in full or in part without liability other than to return any deposit or prepayment which is unearned by reason of the cancellation.

8. CHANGES AND CANCELLATION

Orders accepted by Palmieri are not subject to changes or cancellation by Purchaser without the written consent of Palmieri. In such cases where Palmieri authorizes changes or cancellation, Palmieri reserves the right to charge the Purchaser with reasonable costs based upon expenses already incurred and commitments made by Palmieri, including, without limitation, any labour done, material purchased and also including Supplier's usual overhead and reasonable profit and cancellation charges from Palmieri's suppliers. Palmieri will communicate to the Purchaser additional costs incurred by way of Revised Order Confirmation. Revised Order Confirmation will include applicable costs incurred and modification to lead times (if applicable). The Purchaser must provide Palmieri written confirmation of additional costs, before any changes can be processed on the order.

A minimum charge of \$100.00 NET Change Order Request fee will apply

A minimum charge of \$150.00 NET Cancel Order Request fee will apply.

9. SHIPPING LOCATION / SHIPPING QUOTES / COST OF TRANSPORTATION

Unless otherwise stated, all prices are F.O.B. our factory in Richmond Hill, Ontario, Canada.

Customary methods of transportation shall be selected by Palmieri and such transportation will be at Purchaser's expense. Shipping quotations are made at time of furniture quotation and are outside the control of Palmieri. **Shipping quotes are valid for ten (10) business days from the time of quote.** We do our best to maintain shipping costs as quoted, however all shipping weights and cubic feet shown are approximate only, various construction materials and packaging methods may add to the weights given. All quoted prices, unless otherwise stated on the quotation, are based on the current exchange rates, tariffs, fuel surcharges and costs of manufacture and are subject to change by Palmieri with or without notice until Purchaser's acceptance. Palmieri does not assume responsibility or liability for shipping costs, product during transit, or variances from the shipping weights or cubic feet shown in our specification guides. Special methods of transportation will be used upon Purchaser's request and at Purchaser's additional expense, provided reasonable notice of Purchaser's transportation requirements are given by Purchaser to Palmieri prior to shipment. Palmieri will notify the client prior to shipping product if shipping costs as quoted change, at which point the client must approve the adjusted shipping costs.

10. RECEIVING PRODUCT / REPORTING DAMAGE / STORAGE OF PRODUCT

Upon receipt of Palmieri product, the receiver of the goods must immediately inspect the product to ensure it is free of shipping damage. If the product is deemed in good order, the receiver of the product must ensure

to sign off on the accompanying carriers Bill of lading in good condition. Except for obligations stated under "Warranty" herein, Palmieri's responsibility for the product ceases once the product has been received and signed off in good order and is the full responsibility of the receiver and subsequently the owner.

In the event shipping damage is discovered during receipt of shipment, it is the responsibility of the receiver to ensure all noted damage is recorded on the carrier's Bill of Lading prior to sign off. All noted shipping damage claims must be reported to Palmieri within **24 hours** of receipt of the product onsite, failure to do so will result in the claim being deemed null and void. All shipping damage claims are to be reported directly to Palmieri's Shipping Manager. Please call our toll free number at **1-800-413-4440 ext. 33** or submit the claim by Fax directly to **1-905-731-9878**. Palmieri will not accept any shipping damage claims submitted **after 24 hours** and it shall be conclusively presumed that the goods were delivered in good condition.

Storage of product, Palmieri will not be held responsible for any potential damages or shortages for product shipped and received by Purchaser and is subsequently placed into storage and not inspected within 24 hours of receipt.

11. INSTALLATION / SHORTAGES / BACK CHARGES

Unless otherwise expressly stipulated, the goods shall be installed by and at the risk and expense of Purchaser.

In the event that Palmieri is requested to supervise such installation, Palmieri's responsibility shall be limited to exercising that degree of skill customary in the trade in supervising installations of the same type. Purchaser shall remain responsible for all other aspects of the work including compliance with the local regulations. It is the responsibility of the Purchaser to ensure hardware and parts are received in good order. Packing slip and hardware list to be provided by Palmieri with every order at time of shipping. Purchaser has the responsibility to notify Palmieri immediately without delay of issues that arise; subsequently Palmieri will take action to provide prompt resolution.

Shortages must be reported to Palmieri within **24 hours** of receipt of the goods and failure to do so may be at the expense of the Purchaser.

If deemed missing hardware and parts short shipped from the factory, Palmieri will arrange to ship freight prepaid to destination. Palmieri will only be responsible for replacement costs of missing hardware and parts, any labour costs incurred will be the responsibility of the Purchaser and will not be approved by Palmieri.

Back Charges will only be approved if we deemed a defect in the material or workmanship is found during the installation period resulting in a return trip to the job-site to complete installation. It shall remain the sole discretion of Palmieri to approve (A) repair or (B) replace the furniture and any labour costs incurred by the Purchaser.

12. FORCE MAJEURE

Palmieri shall not be responsible or liable for any loss or damage incurred by Purchaser herein resulting from causes beyond the reasonable control of Palmieri including, but without limitation, abuse, misuse or accident, alteration or modification of product by customer or third party, normal wear and tear, improper installation, handling or incorrect use, unauthorized repairs, the substitution of part components or hardware not approved or authorized by Palmieri, improper storage, and environmental conditions such as irregular temperature control

either inside or outside the environment, acts of God, fire, flood, delays in transportation, or the failure of Palmieri's suppliers to meet their delivery promises. The acceptance of delivery of the goods by Purchaser shall constitute a waiver of all claims for loss or damage due to any delay whatsoever.

13. RETURNED GOODS

No goods may be returned to Palmieri for a credit or exchanged without Palmieri's prior written consent.

Palmieri reserves the right to accept all returns and subject to a handling/restocking charge or to decline all returns. Even after Palmieri has authorized the return of goods for credit, Palmieri reserves the right to adjust the amount of any credit given to Purchaser on return of the goods based on the conditions of the goods on arrival in Palmieri's warehouse. Credit for returned goods will be issued to Purchaser only where such goods are returned by Purchaser and not by any subsequent owner of the goods. Goods will be considered for return only if they are in their original condition and packaging. Palmieri Goods Return Authorization Form to be issued and **must** accompany all shipments returning back to the factory. **Return freight must be prepaid by Purchaser. A minimum 20% re-stocking fee will apply.**

1230 Reid Street
Richmond Hill
Ontario Canada
L4B 1C4

T 905 731 9300
F 905 731 9878
TF 800 413 4440

info@palmierifurniture.com
www.PalmieriFurniture.com









SPECIFICATION GUIDE & PRICE LIST

2017

PALMIERI

PALMIERI KREATIONS®

CATEGORY: LIBRARY FURNITURE
CONTRACT: BID #ESCNJ 17/18-16

Table of Contents	2-3				
Product Materials & Finishes	4-7				
Round Tables	8-43				
 36" Diameter	8-19				
42" Diameter	20-31				
48" Diameter	32-43				
Square Tables	44-91				
 30" Width	44-55				
36" Width	56-67				
42" Width	68-79				
48" Width	80-91				
Rectangle Tables	92-187				
 36" Width	92-103				
48" Width	104-115				
60" Width	116-139				
72" Width	140-163				
84" Width	164-187				
96" Width	188-211				
Trapezoidal Tables	212-215				
 48" Width					
60" Width					
Triangle Tables	216-217				
 30" Width					
36" Width					
		Trio-Squared Tables			218-221
		 48" Width			218-219
		60" Width			220-221
		Trio-Round Tables			222-225
		 48" Width			222-223
		60" Width			224-225
		Trio-Link Tables			226-229
		 48" Width			226-227
		60" Width			228-229
		Quad-Link Tables			230-237
		 36" Width			230-231
		42" Width			232-233
		48" Width			234-235
		60" Width			236-237
		Warranty			238
		Terms & Conditions			239

WOODS & FINISHES:

Natural Maple

Standard

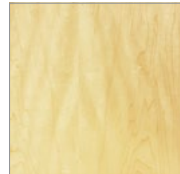

Natural Clear – M-NA

Maple Finishes

The following stains are available, add 10% to list

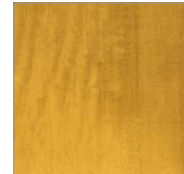

Castle Oak – M-CO



Honey Oak – M-HO

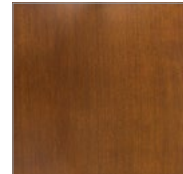

English Oak – M-EN

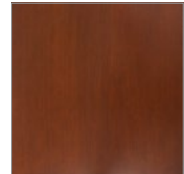

Victorian Cherry – M-VI



Richmond Cherry – M-RC

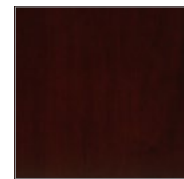

Mahogany – M-MA



Java – M-JA



Wenge – M-WE

Natural Red Oak

Standard

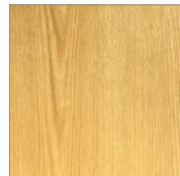

Natural Clear – O-NA

Red Oak Finishes

The following stains are available, add 10% to list

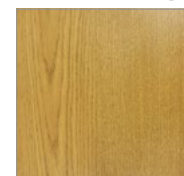

Castle Oak – O-CO

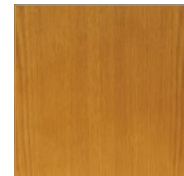

Honey Oak – O-HO

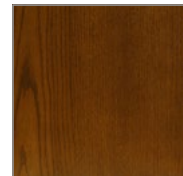

English Oak – O-EN



Victorian Cherry – O-VI



Richmond Cherry – O-RC



Mahogany – O-MA



Java – O-JA



Wenge – O-WE

Natural Cherry

Add 20% to list

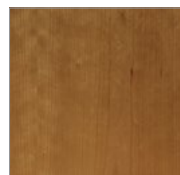

Natural Clear – C-NA

Cherry Finishes

The following stains are available, add 30% to list



Honey Oak – C-HO



Richmond Cherry – C-RC

Natural Walnut

Add 20% to list

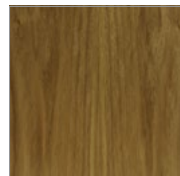

Natural Clear – W-NA

Walnut Finishes

The following stain is available, add 30% to list



Java – W-JA

WILSONART® LAMINATES:

Solid, Abstract and Wood Grain Options



Frosty White
1573-60



Black
1595-60



Island
D498-60

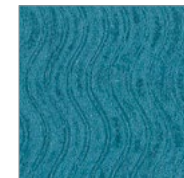

Blue Agave
4919-60



Mambo
7948-60

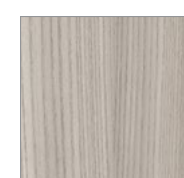

Grey Elm
8201-38



Natural Almond
D30-60



Indigo
D379-60



Hunter Green
D79-60

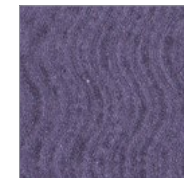

Eggplant
4913-60



Cocobala
7942-38

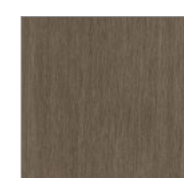

Phantom Cocoa
8213-38

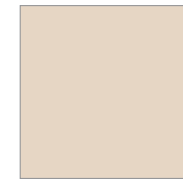

Beige
1530-60

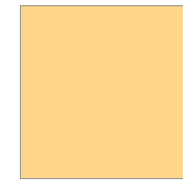

Sunshine
D499-60



Ocean
D502-60

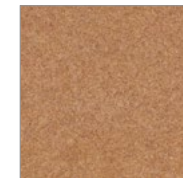

Spiced Zephyr
4859-60

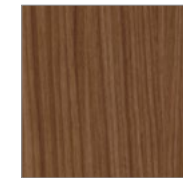

Walnut Heights
7965-38



Studio Teak
7960-38



Fashion Grey
D381-60



Orange Grove
D501-60



Lapis Blue
D417-60



Morro Zephyr
4846-60

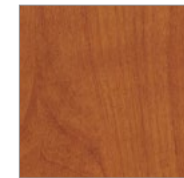

Wild Cherry
7054-60



Skyline Walnut
7964-38



Dove Grey
D92-60



Hollyberry
D307-60



Maroochy Brush
4745-60

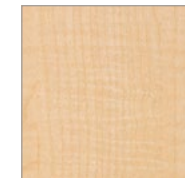

Fusion Maple
7909-60



Phantom Pearl
8211-38



Phantom Charcoal
8214-38



Slate Grey
D91-60



Port
D14-60

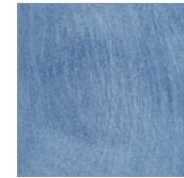

Woolamai Brush
4746-60

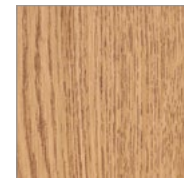

Bannister Oak
7806-60



White Driftwood
8200-38



Asian Night
7949-38

METAL PAINT:

Thermal Paint Colours



White
PS-111-W374



Antique White
W11



Beige
H23



Desert
H432



Red
R66



Ruby
R7



Blue
B11



Navy
B17

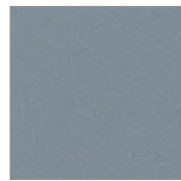

Zinc
A67



Hydro Green
G96



Green
G58



Grey
A16



Charcoal
A230



Black
N49



Pebble
M237

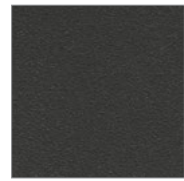

Black Sandtex
N31



Sparkling Silver
S11



Champagne
S14

EDGE BAND COLOURS:

PVC edge band colour options

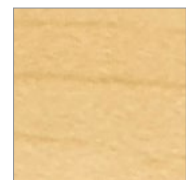

Hardrock Maple
AC-WM791

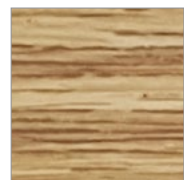

Natural Oak
AC-FWG9877



Chocolate Tick
AC-FWG7424

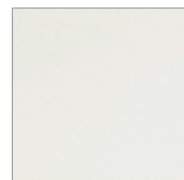

White
AC-SW811



Antique White
AC-W11



Beige
AC-H23



Desert
AC-H432



Red
AC-R66



Ruby
AC-R7



Blue
AC-B11



Navy
AC-B17

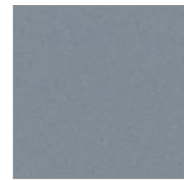

Zinc
AC-A67



Hydro Green
AC-G96



Green
AC-G58



Grey
AC-A16



Charcoal
AC-A230



Black
AC-N49



Pebble
AC-M237

HIGH PRESSURE LAMINATE: Work surface laminate shall be .050" thick and used with balancing backer sheet of no less than .028" thick. Laminate shall conform to standards set by the American Standards Institute/National Electrical Manufacturers Association (ANSI/NEMA) for thickness, performance and appearance. Printed colours, abstract patterns and wood grains are reproduced from representative segments of large sheets and may differ slightly from the actual product.

FINISHING PROCEDURES: All materials shall be inspected and treated with a final sanding and polishing operation before any staining and final finishing can be performed. All machine and mill marks are to be removed. Once the polishing and sanding has been performed, the furniture will then undergo the following stain and finishing procedures:

Step 1 A base stain will be uniformly applied, wiped and then allowed to dry under factory controlled conditions.

Step 2 A uniform coat of sealer will be applied and allowed to dry.

Step 3 Sealer will be lightly sanded using 240 grit silicon paper.

Step 4 A catalytic lacquer of 34-45 degree sheen is evenly applied and allowed to dry under factory controlled conditions.

METAL FINISHING PROCEDURES: All metal components are thoroughly cleaned and coated electrostatically with an epoxy powder coat paint finish. The metal components are then oven baked and cured for a lasting finish.

EDGE BANDS: All edge bands are manufactured in PVC, semi-rigid (Flex) and ABS. Standard edging size are normally 1.25" wide x 3 mm thick. These are made of the highest grade polymers and its materials are extensively tested prior to production using special test procedures and industry specification and quality standards.



*Shown Above:
TB-R36-AC-M-D

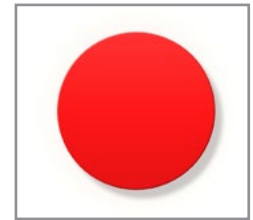

*Round Table Shape

MODEL NUMBER	PRODUCT	WIDTH	DEPTH	HEIGHT	PRICE
	Round Table, 36" Diameter, ACRYLIC Edge;	36"	36"	29"	
	with WOOD Leg Option:	36"	36"	29"	
TB-R36-AC-W-SQ	Square				\$ 1,231
TB-R36-AC-W-SQR	Square Radius				\$ 1,231
TB-R36-AC-W-SQT	Square Tapered				\$ 1,425
TB-R36-AC-W-DT	Diameter Tapered				\$ 1,588
TB-R36-AC-W-SR	Safari				\$ 1,594
	with METAL Leg Option:	36"	36"	29"	
TB-R36-AC-M-SQ	Square				\$ 1,150
TB-R36-AC-M-SS	Square & Stem				\$ 1,688
TB-R36-AC-M-D	Diameter				\$ 1,150
TB-R36-AC-M-DS	Diameter & Stem				\$ 1,688
TB-R36-AC-M-BO	Balloon				\$ 1,281
TB-R36-AC-MC-SQ	Square with Casters				\$ 1,431
TB-R36-AC-MC-SS	Square & Stem with Casters				\$ 1,963
TB-R36-AC-MC-D	Diameter with Casters				\$ 1,431
TB-R36-AC-MC-DS	Diameter & Stem with Casters				\$ 1,963
TB-R36-AC-FP1	Flat Pedestal 19" H	36"	36"	19"	\$ 1,606
TB-R36-AC-FP2	Flat Pedestal 29" H	36"	36"	29"	\$ 1,606
TB-R36-AC-FP3	Flat Pedestal 42" H	36"	36"	42"	\$ 1,844
TB-R36-AC-TP1	Trumpet 19" H	36"	36"	19"	\$ 1,256
TB-R36-AC-TP2	Trumpet 29" H	36"	36"	29"	\$ 1,256
TB-R36-AC-TP3	Trumpet 42" H	36"	36"	42"	\$ 1,719

DESCRIPTION

Each Table Top is constructed using a 1" thick top with a Plastic Laminate top surface.

All Metal legs are coated electrostatically with an epoxy powder coat paint.

NOTES:

* Table heights of 25" (children), 27" (youth), and 32" (wheelchair) are available by request.

* Color of Metal Paint must be specified at the time of order.

* Caster Leg options are recommended for Reading/Multipurpose Tables options and not meant to be used for stationary computer workstations.

* For all tables with casters legs, only 2 legs will have casters, and the other legs will have levelers. This will create a "wheelbarrow" style of table which will ensure ease of mobility.

* Color of the Caster Option must be specified at the time of order.

Edge Option:



'AC"
3mm Acrylic Edge

Metal Leg Options:



Wood Leg Options:

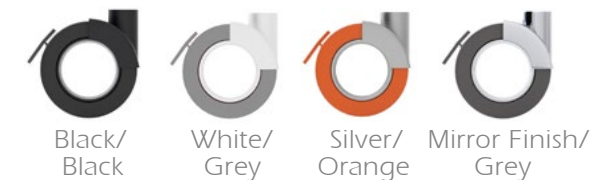
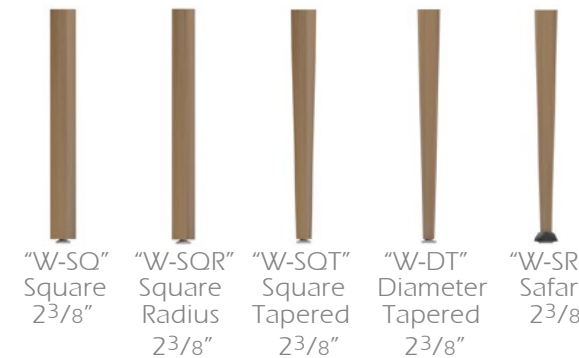

"MC" Caster Option:
Available on all Metal Legs ONLY, with exception of the Balloon leg and Metal Bases.

MODEL NUMBER	PRODUCT	WIDTH	DEPTH	HEIGHT
--------------	---------	-------	-------	--------



*Shown Above:
TB-R36-SQ-M-D

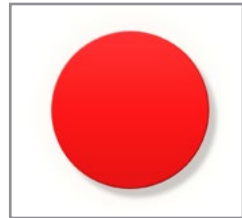

*Round Table Shape

TB-R36-SQ-W-SQ	Round Table, 36" Diameter, SQUARE Edge;	36"	36"	29"
TB-R36-SQ-W-SQR	with WOOD Leg Option: Square	36"	36"	29"
TB-R36-SQ-W-SQT	Square Radius			
TB-R36-SQ-W-DT	Square Tapered			
TB-R36-SQ-W-SR	Diameter Tapered			
	Safari			
TB-R36-SQ-M-SQ	with METAL Leg Option: Square	36"	36"	29"
TB-R36-SQ-M-SS	Square & Stem			
TB-R36-SQ-M-D	Diameter			
TB-R36-SQ-M-DS	Diameter & Stem			
TB-R36-SQ-M-BO	Balloon			
TB-R36-SQ-MC-SQ	Square with Casters			
TB-R36-SQ-MC-SS	Square & Stem with Casters			
TB-R36-SQ-MC-D	Diameter with Casters			
TB-R36-SQ-MC-DS	Diameter & Stem with Casters			

PRICE	DESCRIPTION
-------	-------------

Each Table Top is constructed using a 1 1/8" thick top with a Plastic Laminate top surface.

All Metal legs are coated electrostatically with an epoxy powder coat paint.

NOTES:
 * Table heights of 25" (children), 27" (youth), and 32" (wheelchair) are available by request.
 * Color of Metal Paint must be specified at the time of order.
 * Caster Leg options are recommended for Reading/Multipurpose Tables options and not meant to be used for stationary computer workstations.
 * For all tables with casters legs, only 2 legs will have casters, and the other legs will have levelers. This will create a "wheelbarrow" style of table which will ensure ease of mobility.
 * Color of the Caster Option must be specified at the time of order.

\$ 1,350	
\$ 1,350	
\$ 1,544	
\$ 1,706	
\$ 1,713	
\$ 1,269	
\$ 1,806	
\$ 1,269	
\$ 1,806	
\$ 1,400	
\$ 1,550	
\$ 2,081	
\$ 1,550	
\$ 2,081	

Edge Option:



"SQ"
1/4" Square Edge

Metal Leg Options:

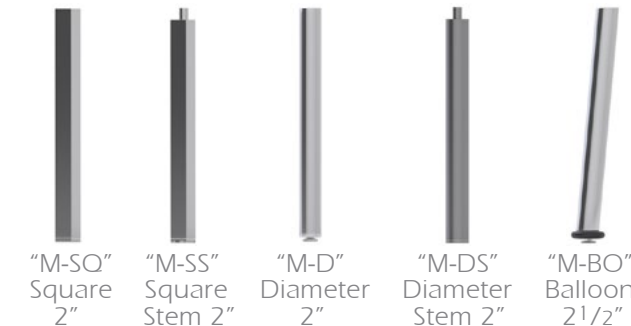

"M-SQ" Square 2"
 "M-SS" Square Stem 2"
 "M-D" Diameter 2"
 "M-DS" Diameter Stem 2"
 "M-BO" Balloon 2 1/2"

Wood Leg Options:

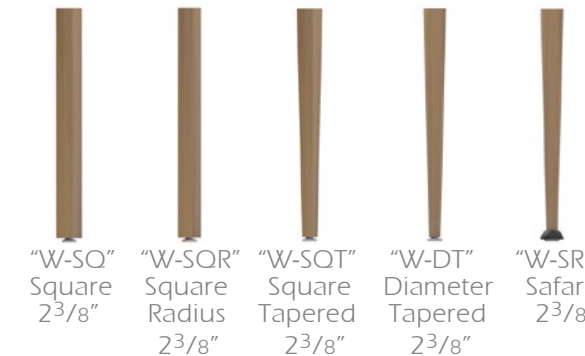

"W-SQ" Square 2 3/8"
 "W-SQR" Square Radius 2 3/8"
 "W-SQT" Square Tapered 2 3/8"
 "W-DT" Diameter Tapered 2 3/8"
 "W-SR" Safari 2 3/8"



"MC" Caster Option:
 Available on all Metal Legs ONLY, with exception of the Balloon leg and Metal Bases.



*Shown Above:
TB-R36-DSQ-M-D

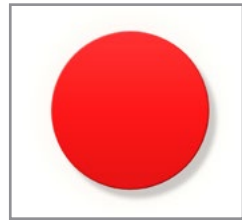

*Round Table Shape

MODEL NUMBER	PRODUCT	WIDTH	DEPTH	HEIGHT
	Round Table, 36" Diameter, DROPPED SQUARE Edge;	36"	36"	29"
	with WOOD Leg Option:	36"	36"	29"
TB-R36-DSQ-W-SQ	Square			
TB-R36-DSQ-W-SQR	Square Radius			
TB-R36-DSQ-W-SQT	Square Tapered			
TB-R36-DSQ-W-DT	Diameter Tapered			
TB-R36-DSQ-W-SR	Safari			
	with METAL Leg Option:	36"	36"	29"
TB-R36-DSQ-M-SQ	Square			
TB-R36-DSQ-M-SS	Square & Stem			
TB-R36-DSQ-M-D	Diameter			
TB-R36-DSQ-M-DS	Diameter & Stem			
TB-R36-DSQ-M-BO	Balloon			
TB-R36-DSQ-MC-SQ	Square with Casters			
TB-R36-DSQ-MC-SS	Square & Stem with Casters			
TB-R36-DSQ-MC-D	Diameter with Casters			
TB-R36-DSQ-MC-DS	Diameter & Stem with Casters			

PRICE	DESCRIPTION
	Each Table Top is constructed using a 1 1/8" thick top with a Plastic Laminate top surface.
	All Metal legs are coated electrostatically with an epoxy powder coat paint.
	NOTES:
\$ 1,406	* Table heights of 25" (children), 27" (youth), and 32" (wheelchair) are available by request.
\$ 1,406	* Color of Metal Paint must be specified at the time of order.
\$ 1,594	* Caster Leg options are recommended for Reading/Multipurpose Tables options and not meant to be used for stationary computer workstations.
\$ 1,756	* For all tables with casters legs, only 2 legs will have casters, and the other legs will have levelers. This will create a "wheelbarrow" style of table which will ensure ease of mobility.
\$ 1,763	* Color of the Caster Option must be specified at the time of order.
\$ 1,325	
\$ 1,856	
\$ 1,325	
\$ 1,856	
\$ 1,450	
\$ 1,606	
\$ 2,138	
\$ 1,606	
\$ 2,138	

Edge Option:



"DSQ"
3/4" Dropped Square Edge

Metal Leg Options:

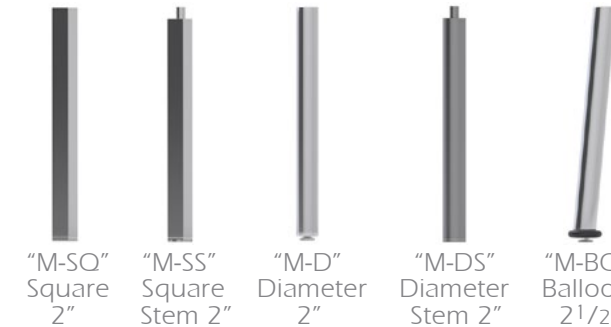

Wood Leg Options:

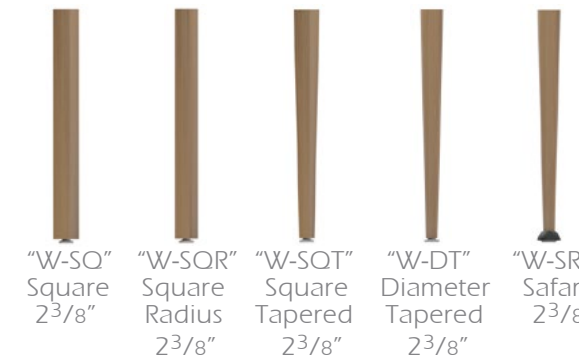

"MC" Caster Option:
Available on all Metal Legs ONLY, with exception of the Balloon leg and Metal Bases.

MODEL NUMBER	PRODUCT	WIDTH	DEPTH	HEIGHT
--------------	---------	-------	-------	--------



*Shown Above:
TB-R36-DBN-M-D



*Round Table Shape

	Round Table, 36" Diameter, DROPPED BULLNOSE Edge;	36"	36"	29"
	with WOOD Leg Option:	36"	36"	29"
TB-R36-DBN-W-SQ	Square			
TB-R36-DBN-W-SQR	Square Radius			
TB-R36-DBN-W-SQT	Square Tapered			
TB-R36-DBN-W-DT	Diameter Tapered			
TB-R36-DBN-W-SR	Safari			
	with METAL Leg Option:	36"	36"	29"
TB-R36-DBN-M-SQ	Square			
TB-R36-DBN-M-SS	Square & Stem			
TB-R36-DBN-M-D	Diameter			
TB-R36-DBN-M-DS	Diameter & Stem			
TB-R36-DBN-M-BO	Balloon			
TB-R36-DBN-MC-SQ	Square with Casters			
TB-R36-DBN-MC-SS	Square & Stem with Casters			
TB-R36-DBN-MC-D	Diameter with Casters			
TB-R36-DBN-MC-DS	Diameter & Stem with Casters			

PRICE	DESCRIPTION
-------	-------------

	Each Table Top is constructed using a 1 1/8" thick top with a Plastic Laminate top surface.
	All Metal legs are coated electrostatically with an epoxy powder coat paint.
	NOTES:
\$ 1,419	* Table heights of 25" (children), 27" (youth), and 32" (wheelchair) are available by request.
\$ 1,419	* Color of Metal Paint must be specified at the time of order.
\$ 1,606	* Caster Leg options are recommended for Reading/Multipurpose Tables options and not meant to be used for stationary computer workstations.
\$ 1,769	* For all tables with casters legs, only 2 legs will have casters, and the other legs will have levelers. This will create a "wheelbarrow" style of table which will ensure ease of mobility.
\$ 1,781	* Color of the Caster Option must be specified at the time of order.

\$ 1,338
\$ 1,869
\$ 1,338
\$ 1,869
\$ 1,469
\$ 1,625
\$ 2,150
\$ 1,625
\$ 2,150

Edge Option:



"DBN"

3/4" Dropped Bullnoses Edge

Metal Leg Options:



"M-SQ" Square 2"
"M-SS" Square Stem 2"
"M-D" Diameter 2"
"M-DS" Diameter Stem 2"
"M-BO" Balloon 2 1/2"

Wood Leg Options:



"W-SQ" Square 2 3/8"
"W-SQR" Square Radius 2 3/8"
"W-SQT" Square Tapered 2 3/8"
"W-DT" Diameter Tapered 2 3/8"
"W-SR" Safari 2 3/8"



Black/Black
White/Grey
Silver/Orange
Mirror Finish/Grey

"MC" Caster Option:
Available on all Metal Legs ONLY, with exception of the Balloon leg and Metal Bases.



*Shown Above:
TB-R36-DCH-M-D

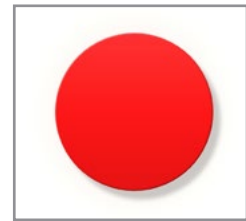

*Round Table Shape

MODEL NUMBER	PRODUCT	WIDTH	DEPTH	HEIGHT	PRICE
	Round Table, 36" Diameter, DROPPED CHAMFERED Edge;	36"	36"	29"	
	with WOOD Leg Option:	36"	36"	29"	
TB-R36-DCH-W-SQ	Square				\$ 1,419
TB-R36-DCH-W-SQR	Square Radius				\$ 1,419
TB-R36-DCH-W-SQT	Square Tapered				\$ 1,606
TB-R36-DCH-W-DT	Diameter Tapered				\$ 1,769
TB-R36-DCH-W-SR	Safari				\$ 1,781
	with METAL Leg Option:	36"	36"	29"	
TB-R36-DCH-M-SQ	Square				\$ 1,338
TB-R36-DCH-M-SS	Square & Stem				\$ 1,869
TB-R36-DCH-M-D	Diameter				\$ 1,338
TB-R36-DCH-M-DS	Diameter & Stem				\$ 1,869
TB-R36-DCH-M-BO	Balloon				\$ 1,469
TB-R36-DCH-MC-SQ	Square with Casters				\$ 1,625
TB-R36-DCH-MC-SS	Square & Stem with Casters				\$ 2,150
TB-R36-DCH-MC-D	Diameter with Casters				\$ 1,625
TB-R36-DCH-MC-DS	Diameter & Stem with Casters				\$ 2,150

DESCRIPTION

Each Table Top is constructed using a 1 1/8" thick top with a Plastic Laminate top surface.

All Metal legs are coated electrostatically with an epoxy powder coat paint.

NOTES:

* Table heights of 25" (children), 27" (youth), and 32" (wheelchair) are available by request.

* Color of Metal Paint must be specified at the time of order.

* Caster Leg options are recommended for Reading/Multipurpose Tables options and not meant to be used for stationary computer workstations.

* For all tables with casters legs, only 2 legs will have casters, and the other legs will have levelers. This will create a "wheelbarrow" style of table which will ensure ease of mobility.

* Color of the Caster Option must be specified at the time of order.

Edge Option:



"DCH"

5/8" Dropped Chamfered Edge

Metal Leg Options:



"M-SQ"
Square
2"

"M-SS"
Square
Stem 2"

"M-D"
Diameter
2"

"M-DS"
Diameter
Stem 2"

"M-BO"
Balloon
2 1/2"

Wood Leg Options:



"W-SQ"
Square
2 3/8"

"W-SQR"
Square
Radius
2 3/8"

"W-SQT"
Square
Tapered
2 3/8"

"W-DT"
Diameter
Tapered
2 3/8"

"W-SR"
Safari
2 3/8"



Black/
Black



White/
Grey

Silver/
Orange

Mirror Finish/
Grey

"MC" Caster Option:

Available on all Metal Legs ONLY, with exception of the Balloon leg and Metal Bases.

MODEL NUMBER	PRODUCT	WIDTH	DEPTH	HEIGHT	PRICE	
 *Shown Above: TB-R36-AL-M-D	Round Table, 36" Diameter,	36"	36"	29"		
	ALUMINUM Edge;					
	with WOOD Leg Option:	36"	36"	29"		
	TB-R36-AL-W-SQ TB-R36-AL-W-SQR TB-R36-AL-W-SQT	Square Square Radius Square Tapered				\$ 1,306 \$ 1,306 \$ 1,500
	TB-R36-AL-W-DT TB-R36-AL-W-SR	Diameter Tapered Safari				\$ 1,663 \$ 1,669
 *Round Table Shape	with METAL Leg Option:	36"	36"	29"		
	TB-R36-AL-M-SQ TB-R36-AL-M-SS TB-R36-AL-M-D TB-R36-AL-M-DS TB-R36-AL-M-BO TB-R36-AL-MC-SQ TB-R36-AL-MC-SS TB-R36-AL-MC-D TB-R36-AL-MC-DS	Square Square & Stem Diameter Diameter & Stem Balloon Square with Casters Square & Stem with Casters Diameter with Casters Diameter & Stem with Casters				\$ 1,231 \$ 1,756 \$ 1,231 \$ 1,756 \$ 1,356 \$ 1,506 \$ 2,044 \$ 1,506 \$ 2,044
	TB-R36-AL-FP1 TB-R36-AL-FP2 TB-R36-AL-FP3 TB-R36-AL-TP1 TB-R36-AL-TP2 TB-R36-AL-TP3	Flat Pedestal 19" H Flat Pedestal 29" H Flat Pedestal 42" H Trumpet 19" H Trumpet 29" H Trumpet 42" H	36" 36" 36" 36" 36" 36"	36" 36" 36" 36" 36" 36"	19" 29" 42" 19" 29" 42"	\$ 1,681 \$ 1,681 \$ 1,919 \$ 1,331 \$ 1,331 \$ 1,794

DESCRIPTION

Each Table Top is constructed using a 1 1/8" thick top with a Plastic Laminate top surface.

All Metal legs are coated electrostatically with an epoxy powder coat paint.

NOTES:

- * Table heights of 25" (children), 27" (youth), and 32" (wheelchair) are available by request.
- * Color of Metal Paint must be specified at the time of order.
- * Caster Leg options are recommended for Reading/Multipurpose Tables options and not meant to be used for stationary computer workstations.
- * For all tables with casters legs, only 2 legs will have casters, and the other legs will have levelers. This will create a "wheelbarrow" style of table which will ensure ease of mobility.
- * Color of the Caster Option must be specified at the time of order.

Edge Option:



"AL"
3mm Aluminum Edge

Metal Leg Options:



"M-SQ" Square 2"
"M-SS" Square Stem 2"
"M-D" Diameter 2"
"M-DS" Diameter Stem 2"
"M-BO" Balloon 2 1/2"
"FP" Flat Pedestal Base
"TP" Trumpet Base

Wood Leg Options:



"W-SQ" Square 2 3/8"
"W-SQR" Square Radius 2 3/8"
"W-SQT" Square Tapered 2 3/8"
"W-DT" Diameter Tapered 2 3/8"
"W-SR" Safari 2 3/8"



Black/Black
White/Grey
Silver/Orange
Mirror Finish/Grey

"MC" Caster Option:

Available on all Metal Legs ONLY, with exception of the Balloon leg and Metal Bases.



*Shown Above:
TB-R42-AC-M-D

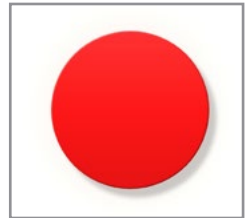

*Round Table Shape

MODEL NUMBER	PRODUCT	WIDTH	DEPTH	HEIGHT	PRICE
	Round Table, 42" Diameter, ACRYLIC Edge;	42"	42"	29"	
	with WOOD Leg Option:	42"	42"	29"	
TB-R42-AC-W-SQ	Square				\$ 1,294
TB-R42-AC-W-SQR	Square Radius				\$ 1,294
TB-R42-AC-W-SQT	Square Tapered				\$ 1,488
TB-R42-AC-W-DT	Diameter Tapered				\$ 1,644
TB-R42-AC-W-SR	Safari				\$ 1,181
	with METAL Leg Option:	42"	42"	29"	
TB-R42-AC-M-SQ	Square				\$ 1,213
TB-R42-AC-M-SS	Square & Stem				\$ 1,744
TB-R42-AC-M-D	Diameter				\$ 1,213
TB-R42-AC-M-DS	Diameter & Stem				\$ 1,744
TB-R42-AC-M-BO	Balloon				\$ 1,344
TB-R42-AC-MC-SQ	Square with Casters				\$ 1,500
TB-R42-AC-MC-SS	Square & Stem with Casters				\$ 2,025
TB-R42-AC-MC-D	Diameter with Casters				\$ 1,500
TB-R42-AC-MC-DS	Diameter & Stem with Casters				\$ 2,025
TB-R42-AC-FP1	Flat Pedestal 19" H	42"	42"	19"	\$ 1,900
TB-R42-AC-FP2	Flat Pedestal 29" H	42"	42"	29"	\$ 1,900
TB-R42-AC-FP3	Flat Pedestal 42" H	42"	42"	42"	\$ 2,000
TB-R42-AC-TP1	Trumpet 19" H	42"	42"	19"	\$ 1,556
TB-R42-AC-TP2	Trumpet 29" H	42"	42"	29"	\$ 1,556
TB-R42-AC-TP3	Trumpet 42" H	42"	42"	42"	\$ 1,781

DESCRIPTION

Each Table Top is constructed using a 1" thick top with a Plastic Laminate top surface.

All Metal legs are coated electrostatically with an epoxy powder coat paint.

NOTES:

- * Table heights of 25" (children), 27" (youth), and 32" (wheelchair) are available by request.
- * Color of Metal Paint must be specified at the time of order.
- * Caster Leg options are recommended for Reading/Multipurpose Tables options and not meant to be used for stationary computer workstations.
- * For all tables with casters legs, only 2 legs will have casters, and the other legs will have levelers. This will create a "wheelbarrow" style of table which will ensure ease of mobility.
- * Color of the Caster Option must be specified at the time of order.

Edge Option:



"AC"
3mm Acrylic Edge

Metal Leg Options:



Wood Leg Options:

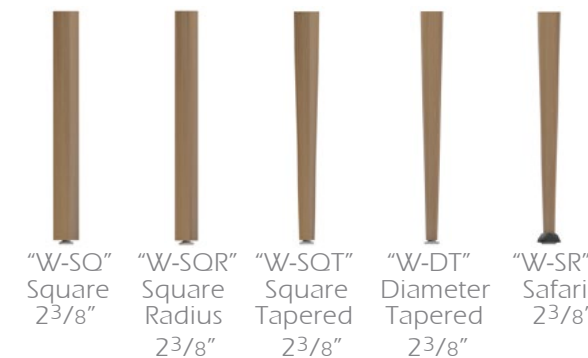

"MC" Caster Option:
Available on all Metal Legs ONLY, with exception of the Balloon leg and Metal Bases.

MODEL NUMBER

PRODUCT

WIDTH DEPTH HEIGHT

PRICE

DESCRIPTION



*Shown Above:
TB-R42-SQ-M-D

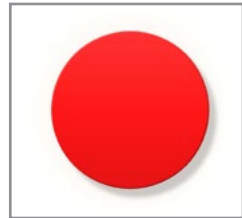

*Round Table Shape

TB-R42-SQ-W-SQ
TB-R42-SQ-W-SQR
TB-R42-SQ-W-SQT
TB-R42-SQ-W-DT
TB-R42-SQ-W-SR

Round Table, 42" Diameter,
SQUARE Edge;
with WOOD Leg Option:
Square
Square Radius
Square Tapered
Diameter Tapered
Safari

42" 42" 29"

\$ 1,425
\$ 1,425
\$ 1,619
\$ 1,781
\$ 1,788

TB-R42-SQ-M-SQ
TB-R42-SQ-M-SS
TB-R42-SQ-M-D
TB-R42-SQ-M-DS
TB-R42-SQ-M-BO
TB-R42-SQ-MC-SQ
TB-R42-SQ-MC-SS
TB-R42-SQ-MC-D
TB-R42-SQ-MC-DS

with METAL Leg Option:
Square
Square & Stem
Diameter
Diameter & Stem
Balloon
Square with Casters
Square & Stem with Casters
Diameter with Casters
Diameter & Stem with Casters

42" 42" 29"

\$ 1,350
\$ 1,881
\$ 1,350
\$ 1,881
\$ 1,475
\$ 1,625
\$ 2,163
\$ 1,625
\$ 2,163

Each Table Top is constructed using a 1 1/8" thick top with a Plastic Laminate top surface.

All Metal legs are coated electrostatically with an epoxy powder coat paint.

NOTES:

- * Table heights of 25" (children), 27" (youth), and 32" (wheelchair) are available by request.
- * Color of Metal Paint must be specified at the time of order.
- * Caster Leg options are recommended for Reading/Multipurpose Tables options and not meant to be used for stationary computer workstations.
- * For all tables with casters legs, only 2 legs will have casters, and the other legs will have levelers. This will create a "wheelbarrow" style of table which will ensure ease of mobility.
- * Color of the Caster Option must be specified at the time of order.

Edge Option:



"SQ"
1/4" Square Edge

Metal Leg Options:



"M-SQ" Square 2"
"M-SS" Square Stem 2"
"M-D" Diameter 2"
"M-DS" Diameter Stem 2"
"M-BO" Balloon 2 1/2"

Wood Leg Options:



"W-SQ" Square 2 3/8"
"W-SQR" Square Radius 2 3/8"
"W-SQT" Square Tapered 2 3/8"
"W-DT" Diameter Tapered 2 3/8"
"W-SR" Safari 2 3/8"



"MC" Caster Option:
Available on all Metal Legs ONLY, with exception of the Balloon leg and Metal Bases.



*Shown Above:
TB-R42-DSO-M-D

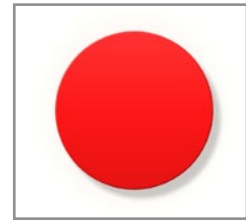

*Round Table Shape

MODEL NUMBER	PRODUCT	WIDTH	DEPTH	HEIGHT
	Round Table, 42" Diameter, DROPPED SQUARE Edge;	42"	42"	29"
	with WOOD Leg Option:	42"	42"	29"
TB-R42-DSO-W-SQ	Square			
TB-R42-DSO-W-SQR	Square Radius			
TB-R42-DSO-W-SQT	Square Tapered			
TB-R42-DSO-W-DT	Diameter Tapered			
TB-R42-DSO-W-SR	Safari			
	with METAL Leg Option:	42"	42"	29"
TB-R42-DSO-M-SQ	Square			
TB-R42-DSO-M-SS	Square & Stem			
TB-R42-DSO-M-D	Diameter			
TB-R42-DSO-M-DS	Diameter & Stem			
TB-R42-DSO-M-BO	Balloon			
TB-R42-DSO-MC-SQ	Square with Casters			
TB-R42-DSO-MC-SS	Square & Stem with Casters			
TB-R42-DSO-MC-D	Diameter with Casters			
TB-R42-DSO-MC-DS	Diameter & Stem with Casters			

PRICE DESCRIPTION

Each Table Top is constructed using a 1 1/8" thick top with a Plastic Laminate top surface.

All Metal legs are coated electrostatically with an epoxy powder coat paint.

NOTES:
 * Table heights of 25" (children), 27" (youth), and 32" (wheelchair) are available by request.
 * Color of Metal Paint must be specified at the time of order.
 * Caster Leg options are recommended for Reading/Multipurpose Tables options and not meant to be used for stationary computer workstations.
 * For all tables with casters legs, only 2 legs will have casters, and the other legs will have levelers. This will create a "wheelbarrow" style of table which will ensure ease of mobility.
 * Color of the Caster Option must be specified at the time of order.

\$ 1,488
 \$ 1,488
 \$ 1,681
 \$ 1,844
 \$ 1,850

\$ 1,406
 \$ 1,944
 \$ 1,406
 \$ 1,944
 \$ 1,538
 \$ 1,694
 \$ 2,219
 \$ 1,694
 \$ 2,219

Edge Option:



"DSO"
3/4" Dropped Square Edge

Metal Leg Options:

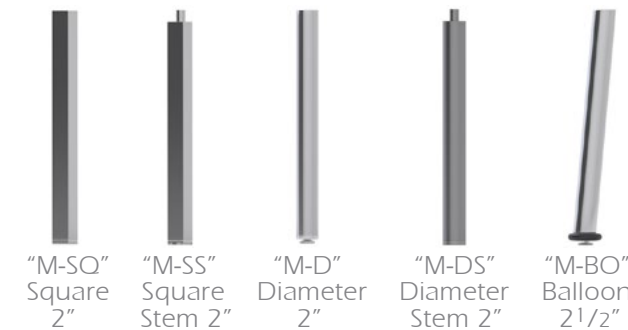

Wood Leg Options:

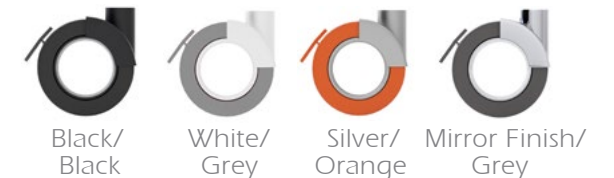
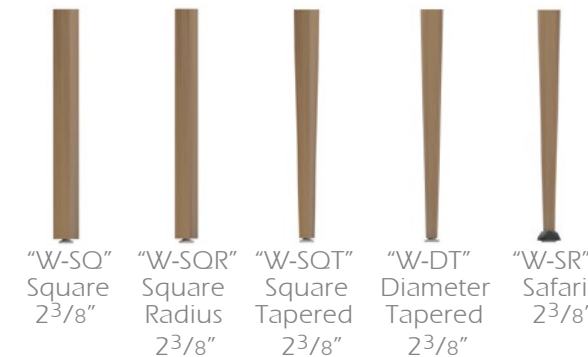

"MC" Caster Option:
Available on all Metal Legs ONLY, with exception of the Balloon leg and Metal Bases.

MODEL NUMBER

PRODUCT

WIDTH DEPTH HEIGHT

PRICE

DESCRIPTION



*Shown Above:
TB-R42-DBN-M-D

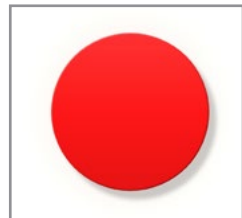

*Round Table Shape

- TB-R42-DBN-W-SQ
- TB-R42-DBN-W-SQR
- TB-R42-DBN-W-SQT
- TB-R42-DBN-W-DT
- TB-R42-DBN-W-SR

Round Table, 42" Diameter,
DROPPED BULLNOSE Edge;
with WOOD Leg Option:
Square
Square Radius
Square Tapered
Diameter Tapered
Safari

42" 42" 29"

- \$ 1,506
- \$ 1,506
- \$ 1,694
- \$ 1,856
- \$ 1,863

- TB-R42-DBN-M-SQ
- TB-R42-DBN-M-SS
- TB-R42-DBN-M-D
- TB-R42-DBN-M-DS
- TB-R42-DBN-M-BO
- TB-R42-DBN-MC-SQ
- TB-R42-DBN-MC-SS
- TB-R42-DBN-MC-D
- TB-R42-DBN-MC-DS

with METAL Leg Option:
Square
Square & Stem
Diameter
Diameter & Stem
Balloon
Square with Casters
Square & Stem with Casters
Diameter with Casters
Diameter & Stem with Casters

42" 42" 29"

- \$ 1,425
- \$ 1,956
- \$ 1,425
- \$ 1,956
- \$ 1,550
- \$ 1,706
- \$ 2,238
- \$ 1,706
- \$ 2,238

Each Table Top is constructed using a 1 1/8" thick top with a Plastic Laminate top surface.

All Metal legs are coated electrostatically with an epoxy powder coat paint.

NOTES:

- * Table heights of 25" (children), 27" (youth), and 32" (wheelchair) are available by request.
- * Color of Metal Paint must be specified at the time of order.
- * Caster Leg options are recommended for Reading/Multipurpose Tables options and not meant to be used for stationary computer workstations.
- * For all tables with casters legs, only 2 legs will have casters, and the other legs will have levelers. This will create a "wheelbarrow" style of table which will ensure ease of mobility.
- * Color of the Caster Option must be specified at the time of order.

Edge Option:



"DBN"

3/4" Dropped Bullnoses Edge

Metal Leg Options:



- "M-SQ" Square 2"
- "M-SS" Square Stem 2"
- "M-D" Diameter 2"
- "M-DS" Diameter Stem 2"
- "M-BO" Balloon 2 1/2"

Wood Leg Options:



- "W-SQ" Square 2 3/8"
- "W-SQR" Square Radius 2 3/8"
- "W-SQT" Square Tapered 2 3/8"
- "W-DT" Diameter Tapered 2 3/8"
- "W-SR" Safari 2 3/8"



"MC" Caster Option:
Available on all Metal Legs ONLY, with exception of the Balloon leg and Metal Bases.



*Shown Above:
TB-R42-DCH-M-D

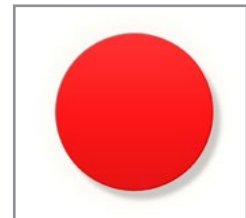

*Round Table Shape

MODEL NUMBER	PRODUCT	WIDTH	DEPTH	HEIGHT
	Round Table, 42" Diameter, DROPPED CHAMFERED Edge;	42"	42"	29"
	with WOOD Leg Option:	42"	42"	29"
TB-R42-DCH-W-SQ	Square			
TB-R42-DCH-W-SQR	Square Radius			
TB-R42-DCH-W-SQT	Square Tapered			
TB-R42-DCH-W-DT	Diameter Tapered			
TB-R42-DCH-W-SR	Safari			
	with METAL Leg Option:	42"	42"	29"
TB-R42-DCH-M-SQ	Square			
TB-R42-DCH-M-SS	Square & Stem			
TB-R42-DCH-M-D	Diameter			
TB-R42-DCH-M-DS	Diameter & Stem			
TB-R42-DCH-M-BO	Balloon			
TB-R42-DCH-MC-SQ	Square with Casters			
TB-R42-DCH-MC-SS	Square & Stem with Casters			
TB-R42-DCH-MC-D	Diameter with Casters			
TB-R42-DCH-MC-DS	Diameter & Stem with Casters			

PRICE DESCRIPTION

Each Table Top is constructed using a 1 1/8" thick top with a Plastic Laminate top surface.

All Metal legs are coated electrostatically with an epoxy powder coat paint.

NOTES:
 * Table heights of 25" (children), 27" (youth), and 32" (wheelchair) are available by request.
 * Color of Metal Paint must be specified at the time of order.
 * Caster Leg options are recommended for Reading/Multipurpose Tables options and not meant to be used for stationary computer workstations.
 * For all tables with casters legs, only 2 legs will have casters, and the other legs will have levelers. This will create a "wheelbarrow" style of table which will ensure ease of mobility.
 * Color of the Caster Option must be specified at the time of order.

\$ 1,506
 \$ 1,506
 \$ 1,694
 \$ 1,856
 \$ 1,863

 \$ 1,425
 \$ 1,956
 \$ 1,425
 \$ 1,956
 \$ 1,550
 \$ 1,706
 \$ 2,238
 \$ 1,706
 \$ 2,238

Edge Option:



"DCH"
5/8" Dropped Chamfered Edge

Metal Leg Options:

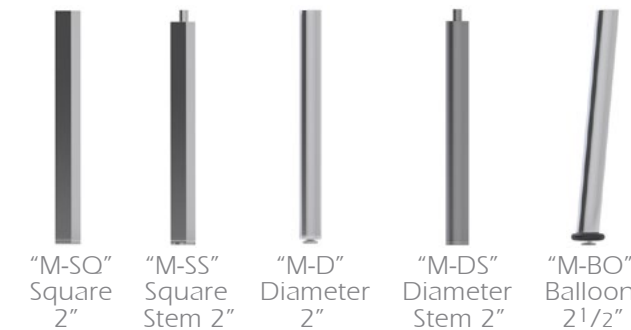

"M-SQ" Square 2"
 "M-SS" Square Stem 2"
 "M-D" Diameter 2"
 "M-DS" Diameter Stem 2"
 "M-BO" Balloon 2 1/2"

Wood Leg Options:

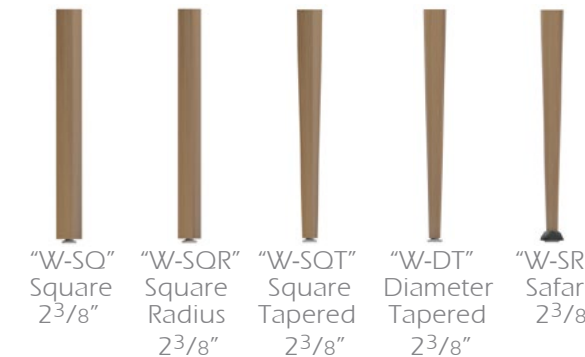

"W-SQ" Square 2 3/8"
 "W-SQR" Square Radius 2 3/8"
 "W-SQT" Square Tapered 2 3/8"
 "W-DT" Diameter Tapered 2 3/8"
 "W-SR" Safari 2 3/8"



Black/Black White/Grey Silver/Orange Mirror Finish/Grey

"MC" Caster Option:
Available on all Metal Legs ONLY, with exception of the Balloon leg and Metal Bases.



*Shown Above:
TB-R42-AL-M-D

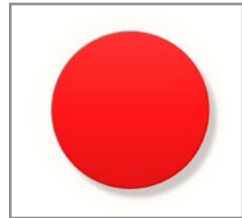

*Round Table Shape

MODEL NUMBER	PRODUCT	WIDTH	DEPTH	HEIGHT	PRICE
	Round Table, 42" Diameter, ALUMINUM Edge;	42"	42"	29"	
	with WOOD Leg Option:	42"	42"	29"	
TB-R42-AL-W-SO	Square				\$ 1,375
TB-R42-AL-W-SQR	Square Radius				\$ 1,375
TB-R42-AL-W-SQT	Square Tapered				\$ 1,569
TB-R42-AL-W-DT	Diameter Tapered				\$ 1,725
TB-R42-AL-W-SR	Safari				\$ 1,738
	with METAL Leg Option:	42"	42"	29"	
TB-R42-AL-M-SO	Square				\$ 1,294
TB-R42-AL-M-SS	Square & Stem				\$ 1,825
TB-R42-AL-M-D	Diameter				\$ 1,294
TB-R42-AL-M-DS	Diameter & Stem				\$ 1,825
TB-R42-AL-M-BO	Balloon				\$ 1,425
TB-R42-AL-MC-SQ	Square with Casters				\$ 1,575
TB-R42-AL-MC-SS	Square & Stem with Casters				\$ 2,106
TB-R42-AL-MC-D	Diameter with Casters				\$ 1,575
TB-R42-AL-MC-DS	Diameter & Stem with Casters				\$ 2,106
TB-R42-AL-FP1	Flat Pedestal 19" H	42"	42"	19"	\$ 1,981
TB-R42-AL-FP2	Flat Pedestal 29" H	42"	42"	29"	\$ 1,981
TB-R42-AL-FP3	Flat Pedestal 42" H	42"	42"	42"	\$ 2,081
TB-R42-AL-TP1	Trumpet 19" H	42"	42"	19"	\$ 1,638
TB-R42-AL-TP2	Trumpet 29" H	42"	42"	29"	\$ 1,638
TB-R42-AL-TP3	Trumpet 42" H	42"	42"	42"	\$ 1,863

Each Table Top is constructed using a 1 1/8" thick top with a Plastic Laminate top surface.

All Metal legs are coated electrostatically with an epoxy powder coat paint.

NOTES:

* Table heights of 25" (children), 27" (youth), and 32" (wheelchair) are available by request.

* Color of Metal Paint must be specified at the time of order.

* Caster Leg options are recommended for Reading/Multipurpose Tables options and not meant to be used for stationary computer workstations.

* For all tables with casters legs, only 2 legs will have casters, and the other legs will have levelers. This will create a "wheelbarrow" style of table which will ensure ease of mobility.

* Color of the Caster Option must be specified at the time of order.

Edge Option:



"AL"
3mm Aluminum Edge

Metal Leg Options:



Wood Leg Options:

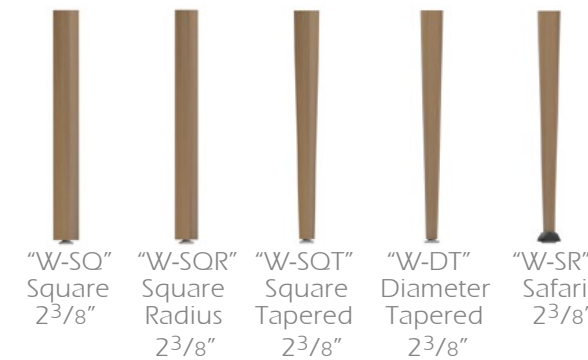

"MC" Caster Option:
Available on all Metal Legs ONLY, with exception of the Balloon leg and Metal Bases.



*Shown Above:
TB-R48-AC-M-D

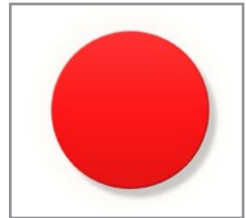

*Round Table Shape

MODEL NUMBER	PRODUCT	WIDTH	DEPTH	HEIGHT	PRICE
	Round Table, 48" Diameter, ACRYLIC Edge;	48"	48"	29"	
	with WOOD Leg Option:	48"	48"	29"	
TB-R48-AC-W-SQ	Square				\$ 1,363
TB-R48-AC-W-SQR	Square Radius				\$ 1,363
TB-R48-AC-W-SQT	Square Tapered				\$ 1,550
TB-R48-AC-W-DT	Diameter Tapered				\$ 1,713
TB-R48-AC-W-SR	Safari				\$ 1,725
	with METAL Leg Option:	48"	48"	29"	
TB-R48-AC-M-SQ	Square				\$ 1,281
TB-R48-AC-M-SS	Square & Stem				\$ 1,844
TB-R48-AC-M-D	Diameter				\$ 1,281
TB-R48-AC-M-DS	Diameter & Stem				\$ 1,813
TB-R48-AC-M-BO	Balloon				\$ 1,406
TB-R48-AC-MC-SQ	Square with Casters				\$ 1,569
TB-R48-AC-MC-SS	Square & Stem with Casters				\$ 2,094
TB-R48-AC-MC-D	Diameter with Casters				\$ 1,569
TB-R48-AC-MC-DS	Diameter & Stem with Casters				\$ 2,094
TB-R48-AC-FP1	Flat Pedestal 19" H	48"	48"	19"	\$ 2,375
TB-R48-AC-FP2	Flat Pedestal 29" H	48"	48"	29"	\$ 2,375
TB-R48-AC-FP3	Flat Pedestal 42" H	48"	48"	42"	\$ 2,469
TB-R48-AC-TP1	Trumpet 19" H	48"	48"	19"	\$ 1,625
TB-R48-AC-TP2	Trumpet 29" H	48"	48"	29"	\$ 1,625
TB-R48-AC-TP3	Trumpet 42" H	48"	48"	42"	\$ 1,844

DESCRIPTION

Each Table Top is constructed using a 1" thick top with a Plastic Laminate top surface.

All Metal legs are coated electrostatically with an epoxy powder coat paint.

NOTES:

* Table heights of 25" (children), 27" (youth), and 32" (wheelchair) are available by request.

* Color of Metal Paint must be specified at the time of order.

* Caster Leg options are recommended for Reading/Multipurpose Tables options and not meant to be used for stationary computer workstations.

* For all tables with casters legs, only 2 legs will have casters, and the other legs will have levelers. This will create a "wheelbarrow" style of table which will ensure ease of mobility.

* Color of the Caster Option must be specified at the time of order.

Edge Option:



"AC"

3mm Acrylic Edge

Metal Leg Options:



"M-SQ"
Square
2"

"M-SS"
Square
Stem 2"

"M-D"
Diameter
2"

"M-DS"
Diameter
Stem 2"

"M-BO"
Balloon
2 1/2"

"FP"
Flat Pedestal
Base

"TP"
Trumpet
Base

Wood Leg Options:



"W-SQ"
Square
2 3/8"

"W-SQR"
Square
Radius
2 3/8"

"W-SQT"
Square
Tapered
2 3/8"

"W-DT"
Diameter
Tapered
2 3/8"

"W-SR"
Safari
2 3/8"



Black/
Black

White/
Grey

Silver/
Orange

Mirror Finish/
Grey

"MC" Caster Option:

Available on all Metal Legs ONLY, with exception of the Balloon leg and Metal Bases.

MODEL NUMBER	PRODUCT	WIDTH	DEPTH	HEIGHT
--------------	---------	-------	-------	--------



*Shown Above:
TB-R48-SQ-M-D

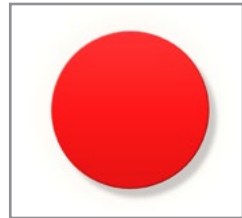

*Round Table Shape

TB-R48-SQ-W-SQ
TB-R48-SQ-W-SQR
TB-R48-SQ-W-SQT
TB-R48-SQ-W-DT
TB-R48-SQ-W-SR

Round Table, 48" Diameter,
SQUARE Edge;
with WOOD Leg Option:
Square
Square Radius
Square Tapered
Diameter Tapered
Safari

48" 48" 29"

TB-R48-SQ-M-SQ
TB-R48-SQ-M-SS
TB-R48-SQ-M-D
TB-R48-SQ-M-DS
TB-R48-SQ-M-BO
TB-R48-SQ-MC-SQ
TB-R48-SQ-MC-SS
TB-R48-SQ-MC-D
TB-R48-SQ-MC-DS

with METAL Leg Option:
Square
Square & Stem
Diameter
Diameter & Stem
Balloon
Square with Casters
Square & Stem with Casters
Diameter with Casters
Diameter & Stem with Casters

48" 48" 29"

PRICE	DESCRIPTION
-------	-------------

\$ 1,513
\$ 1,513
\$ 1,706
\$ 1,863
\$ 1,875

\$ 1,431
\$ 1,963
\$ 1,431
\$ 1,963
\$ 1,563
\$ 1,713
\$ 2,244
\$ 1,713
\$ 2,244

Each Table Top is constructed using a 1 1/8" thick top with a Plastic Laminate top surface.

All Metal legs are coated electrostatically with an epoxy powder coat paint.

NOTES:

- * Table heights of 25" (children), 27" (youth), and 32" (wheelchair) are available by request.
- * Color of Metal Paint must be specified at the time of order.
- * Caster Leg options are recommended for Reading/Multipurpose Tables options and not meant to be used for stationary computer workstations.
- * For all tables with casters legs, only 2 legs will have casters, and the other legs will have levelers. This will create a "wheelbarrow" style of table which will ensure ease of mobility.
- * Color of the Caster Option must be specified at the time of order.

Edge Option:



"SQ"
1/4" Square Edge

Metal Leg Options:



"M-SQ" Square 2"
"M-SS" Square Stem 2"
"M-D" Diameter 2"
"M-DS" Diameter Stem 2"
"M-BO" Balloon 2 1/2"

Wood Leg Options:



"W-SQ" Square 2 3/8"
"W-SQR" Square Radius 2 3/8"
"W-SQT" Square Tapered 2 3/8"
"W-DT" Diameter Tapered 2 3/8"
"W-SR" Safari 2 3/8"



"MC" Caster Option:
Available on all Metal Legs ONLY, with exception of the Balloon leg and Metal Bases.

MODEL NUMBER	PRODUCT	WIDTH	DEPTH	HEIGHT	
 *Shown Above: TB-R48-DSO-M-D	Round Table, 48" Diameter,	48"	48"	29"	
	DROPPED SQUARE Edge;				
	with WOOD Leg Option:	48"	48"	29"	
	TB-R48-DSO-W-SQ TB-R48-DSO-W-SQR TB-R48-DSO-W-SQT TB-R48-DSO-W-DT TB-R48-DSO-W-SR	Square Square Radius Square Tapered Diameter Tapered Safari			
	with METAL Leg Option:	48"	48"	29"	
TB-R48-DSO-M-SQ TB-R48-DSO-M-SS TB-R48-DSO-M-D TB-R48-DSO-M-DS TB-R48-DSO-M-BO TB-R48-DSO-MC-SQ TB-R48-DSO-MC-SS TB-R48-DSO-MC-D TB-R48-DSO-MC-DS	Square Square & Stem Diameter Diameter & Stem Balloon Square with Casters Square & Stem with Casters Diameter with Casters Diameter & Stem with Casters				

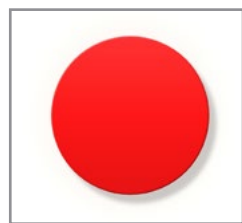

*Round Table Shape

PRICE	DESCRIPTION
	Each Table Top is constructed using a 1 1/8" thick top with a Plastic Laminate top surface.
	All Metal legs are coated electrostatically with an epoxy powder coat paint.
	NOTES:
\$ 1,588	* Table heights of 25" (children), 27" (youth), and 32" (wheelchair) are available by request.
\$ 1,588	* Color of Metal Paint must be specified at the time of order.
\$ 1,781	* Caster Leg options are recommended for Reading/Multipurpose Tables options and not meant to be used for stationary computer workstations.
\$ 1,944	* For all tables with casters legs, only 2 legs will have casters, and the other legs will have levelers. This will create a "wheelbarrow" style of table which will ensure ease of mobility.
\$ 1,950	* Color of the Caster Option must be specified at the time of order.
\$ 1,506	
\$ 2,038	
\$ 1,506	
\$ 2,038	
\$ 1,638	
\$ 1,788	
\$ 2,319	
\$ 1,788	
\$ 2,319	

Edge Option:



"DSO"
3/4" Dropped Square Edge

Metal Leg Options:

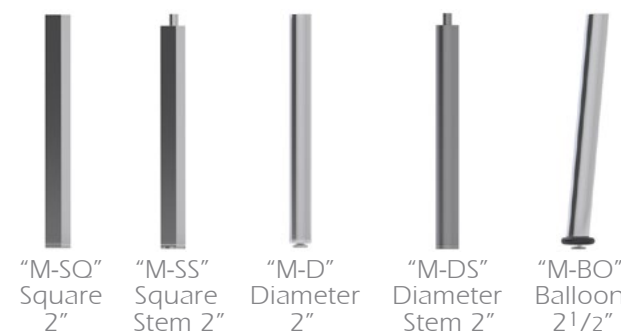

"M-SQ" Square 2"
"M-SS" Square Stem 2"
"M-D" Diameter 2"
"M-DS" Diameter Stem 2"
"M-BO" Balloon 2 1/2"

Wood Leg Options:

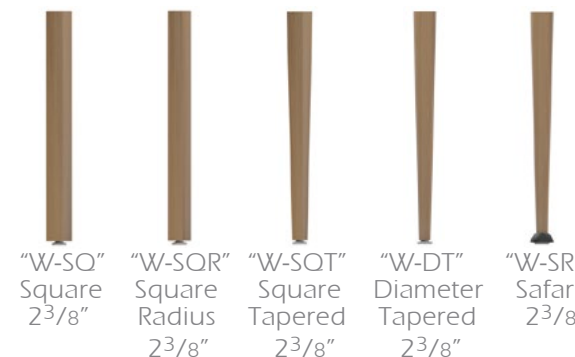

"W-SQ" Square 2 3/8"
"W-SQR" Square Radius 2 3/8"
"W-SQT" Square Tapered 2 3/8"
"W-DT" Diameter Tapered 2 3/8"
"W-SR" Safari 2 3/8"



"MC" Caster Option:
Available on all Metal Legs ONLY, with exception of the Balloon leg and Metal Bases.

MODEL NUMBER

PRODUCT

WIDTH DEPTH HEIGHT

PRICE

DESCRIPTION



*Shown Above:
TB-R48-DBN-M-D



*Round Table Shape

- TB-R48-DBN-W-SQ
- TB-R48-DBN-W-SQR
- TB-R48-DBN-W-SQT
- TB-R48-DBN-W-DT
- TB-R48-DBN-W-SR

Round Table, 48" Diameter,
DROPPED BULLNOSE Edge;
with WOOD Leg Option:
Square
Square Radius
Square Tapered
Diameter Tapered
Safari

48" 48" 29"

- \$ 1,606
- \$ 1,606
- \$ 1,794
- \$ 1,956
- \$ 1,963

- TB-R48-DBN-M-SQ
- TB-R48-DBN-M-SS
- TB-R48-DBN-M-D
- TB-R48-DBN-M-DS
- TB-R48-DBN-M-BO
- TB-R48-DBN-MC-SQ
- TB-R48-DBN-MC-SS
- TB-R48-DBN-MC-D
- TB-R48-DBN-MC-DS

with METAL Leg Option:
Square
Square & Stem
Diameter
Diameter & Stem
Balloon
Square with Casters
Square & Stem with Casters
Diameter with Casters
Diameter & Stem with Casters

48" 48" 29"

- \$ 1,525
- \$ 2,050
- \$ 1,525
- \$ 2,050
- \$ 1,650
- \$ 1,806
- \$ 2,338
- \$ 1,806
- \$ 2,338

Each Table Top is constructed using a 1 1/8" thick top with a Plastic Laminate top surface.

All Metal legs are coated electrostatically with an epoxy powder coat paint.

NOTES:

- * Table heights of 25" (children), 27" (youth), and 32" (wheelchair) are available by request.
- * Color of Metal Paint must be specified at the time of order.
- * Caster Leg options are recommended for Reading/Multipurpose Tables options and not meant to be used for stationary computer workstations.
- * For all tables with casters legs, only 2 legs will have casters, and the other legs will have levelers. This will create a "wheelbarrow" style of table which will ensure ease of mobility.
- * Color of the Caster Option must be specified at the time of order.

Edge Option:



"DBN"

3/4" Dropped Bullnoses Edge

Metal Leg Options:



- "M-SQ" Square 2"
- "M-SS" Square Stem 2"
- "M-D" Diameter 2"
- "M-DS" Diameter Stem 2"
- "M-BO" Balloon 2 1/2"

Wood Leg Options:



- "W-SQ" Square 2 3/8"
- "W-SQR" Square Radius 2 3/8"
- "W-SQT" Square Tapered 2 3/8"
- "W-DT" Diameter Tapered 2 3/8"
- "W-SR" Safari 2 3/8"



- Black/Black
- White/Grey
- Silver/Orange
- Mirror Finish/Grey

"MC" Caster Option:
Available on all Metal Legs ONLY, with exception of the Balloon leg and Metal Bases.



*Shown Above:
TB-R48-DCH-M-D

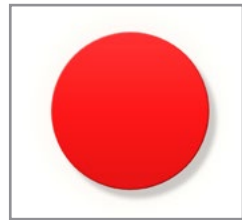

*Round Table Shape

MODEL NUMBER	PRODUCT	WIDTH	DEPTH	HEIGHT
	Round Table, 48" Diameter, DROPPED CHAMFERED Edge;	48"	48"	29"
	with WOOD Leg Option:	48"	48"	29"
TB-R48-DCH-W-SQ	Square			
TB-R48-DCH-W-SQR	Square Radius			
TB-R48-DCH-W-SQT	Square Tapered			
TB-R48-DCH-W-DT	Diameter Tapered			
TB-R48-DCH-W-SR	Safari			
	with METAL Leg Option:	48"	48"	29"
TB-R48-DCH-M-SQ	Square			
TB-R48-DCH-M-SS	Square & Stem			
TB-R48-DCH-M-D	Diameter			
TB-R48-DCH-M-DS	Diameter & Stem			
TB-R48-DCH-M-BO	Balloon			
TB-R48-DCH-MC-SQ	Square with Casters			
TB-R48-DCH-MC-SS	Square & Stem with Casters			
TB-R48-DCH-MC-D	Diameter with Casters			
TB-R48-DCH-MC-DS	Diameter & Stem with Casters			

PRICE DESCRIPTION

Each Table Top is constructed using a 1 1/8" thick top with a Plastic Laminate top surface.

All Metal legs are coated electrostatically with an epoxy powder coat paint.

NOTES:
 * Table heights of 25" (children), 27" (youth), and 32" (wheelchair) are available by request.
 * Color of Metal Paint must be specified at the time of order.
 * Caster Leg options are recommended for Reading/Multipurpose Tables options and not meant to be used for stationary computer workstations.
 * For all tables with casters legs, only 2 legs will have casters, and the other legs will have levelers. This will create a "wheelbarrow" style of table which will ensure ease of mobility.
 * Color of the Caster Option must be specified at the time of order.

\$ 1,606
 \$ 1,606
 \$ 1,794
 \$ 1,956
 \$ 1,963

 \$ 1,525
 \$ 2,050
 \$ 1,525
 \$ 2,050
 \$ 1,650
 \$ 1,806
 \$ 2,338
 \$ 1,806
 \$ 2,338

Edge Option:



"DCH"
5/8" Dropped Chamfered Edge

Metal Leg Options:

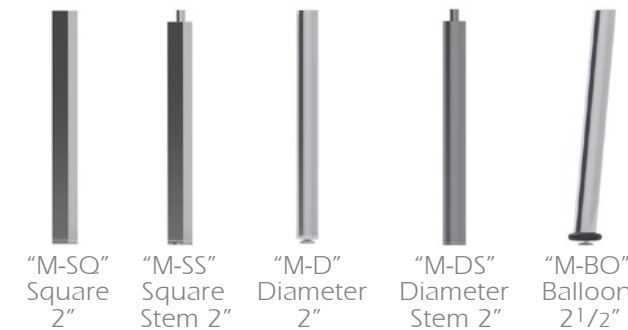

"M-SQ" Square 2"
 "M-SS" Square Stem 2"
 "M-D" Diameter 2"
 "M-DS" Diameter Stem 2"
 "M-BO" Balloon 2 1/2"

Wood Leg Options:

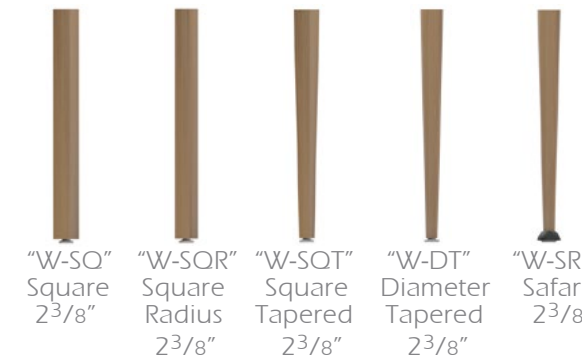

"W-SQ" Square 2 3/8"
 "W-SQR" Square Radius 2 3/8"
 "W-SQT" Square Tapered 2 3/8"
 "W-DT" Diameter Tapered 2 3/8"
 "W-SR" Safari 2 3/8"



"MC" Caster Option:
Available on all Metal Legs ONLY, with exception of the Balloon leg and Metal Bases.



*Shown Above:
TB-R48-AL-M-D

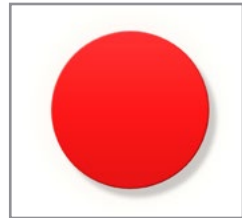

*Round Table Shape

MODEL NUMBER	PRODUCT	WIDTH	DEPTH	HEIGHT	PRICE
	Round Table, 48" Diameter, ALUMINUM Edge;	48"	48"	29"	
	with WOOD Leg Option:	48"	48"	29"	
TB-R48-AL-W-SQ	Square				\$ 1,450
TB-R48-AL-W-SQR	Square Radius				\$ 1,450
TB-R48-AL-W-SQT	Square Tapered				\$ 1,644
TB-R48-AL-W-DT	Diameter Tapered				\$ 1,806
TB-R48-AL-W-SR	Safari				\$ 1,813
	with METAL Leg Option:	48"	48"	29"	
TB-R48-AL-M-SQ	Square				\$ 1,369
TB-R48-AL-M-SS	Square & Stem				\$ 1,900
TB-R48-AL-M-D	Diameter				\$ 1,369
TB-R48-AL-M-DS	Diameter & Stem				\$ 1,900
TB-R48-AL-M-BO	Balloon				\$ 1,500
TB-R48-AL-MC-SQ	Square with Casters				\$ 1,656
TB-R48-AL-MC-SS	Square & Stem with Casters				\$ 2,181
TB-R48-AL-MC-D	Diameter with Casters				\$ 1,656
TB-R48-AL-MC-DS	Diameter & Stem with Casters				\$ 2,181
TB-R48-AL-FP1	Flat Pedestal 19" H	48"	48"	19"	\$ 2,463
TB-R48-AL-FP2	Flat Pedestal 29" H	48"	48"	29"	\$ 2,463
TB-R48-AL-FP3	Flat Pedestal 42" H	48"	48"	42"	\$ 2,556
TB-R48-AL-TP1	Trumpet 19" H	48"	48"	19"	\$ 1,713
TB-R48-AL-TP2	Trumpet 29" H	48"	48"	29"	\$ 1,713
TB-R48-AL-TP3	Trumpet 42" H	48"	48"	42"	\$ 1,938

DESCRIPTION

Each Table Top is constructed using a 1 1/8" thick top with a Plastic Laminate top surface.

All Metal legs are coated electrostatically with an epoxy powder coat paint.

NOTES:

* Table heights of 25" (children), 27" (youth), and 32" (wheelchair) are available by request.

* Color of Metal Paint must be specified at the time of order.

* Caster Leg options are recommended for Reading/Multipurpose Tables options and not meant to be used for stationary computer workstations.

* For all tables with casters legs, only 2 legs will have casters, and the other legs will have levelers. This will create a "wheelbarrow" style of table which will ensure ease of mobility.

* Color of the Caster Option must be specified at the time of order.

Edge Option:



"AL"
3mm Aluminum Edge

Metal Leg Options:



"M-SQ" Square 2"
"M-SS" Square Stem 2"
"M-D" Diameter 2"
"M-DS" Diameter Stem 2"
"M-BO" Balloon 2 1/2"
"FP" Flat Pedestal Base
"TP" Trumpet Base

Wood Leg Options:

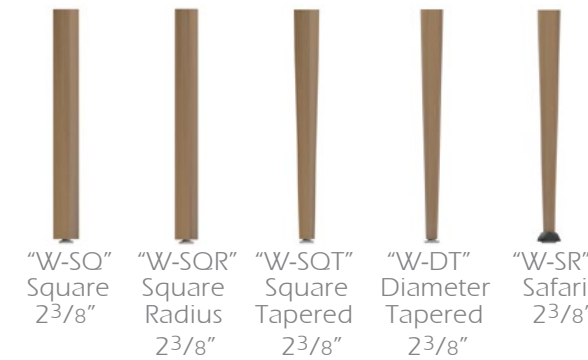

"W-SQ" Square 2 3/8"
"W-SQR" Square Radius 2 3/8"
"W-SQT" Square Tapered 2 3/8"
"W-DT" Diameter Tapered 2 3/8"
"W-SR" Safari 2 3/8"



"MC" Caster Option:
Available on all Metal Legs ONLY, with exception of the Balloon leg and Metal Bases.

MODEL NUMBER	PRODUCT	WIDTH	DEPTH	HEIGHT
--------------	---------	-------	-------	--------

	Square Table, 30" Width, ACRYLIC Edge;	30"	30"	29"
	with WOOD Leg Option:	30"	30"	29"
TB-3030-AC-W-SQ	Square			
TB-3030-AC-W-SQR	Square Radius			
TB-3030-AC-W-SQT	Square Tapered			
TB-3030-AC-W-DT	Diameter Tapered			
TB-3030-AC-W-SR	Safari			
	with METAL Leg Option:	30"	30"	29"
TB-3030-AC-M-SQ	Square			
TB-3030-AC-M-SS	Square & Stem			
TB-3030-AC-M-D	Diameter			
TB-3030-AC-M-DS	Diameter & Stem			
TB-3030-AC-M-BO	Balloon			
TB-3030-AC-MC-SQ	Square with Casters			
TB-3030-AC-MC-SS	Square & Stem with Casters			
TB-3030-AC-MC-D	Diameter with Casters			
TB-3030-AC-MC-DS	Diameter & Stem with Casters			



*Shown Above:
TB-3030-AC-M-D



*Square Table Shape

PRICE	DESCRIPTION
-------	-------------

	Each Table Top is constructed using a 1" thick top with a Plastic Laminate top surface.
	All Metal legs are coated electrostatically with an epoxy powder coat paint.
	NOTES:
\$ 1,019	* Table heights of 25" (children), 27" (youth), and 32" (wheelchair) are available by request.
\$ 1,019	* Color of Metal Paint must be specified at the time of order.
\$ 1,213	* Caster Leg options are recommended for Reading/Multipurpose Tables options and not meant to be used for stationary computer workstations.
\$ 1,369	* For all tables with casters legs, only 2 legs will have casters, and the other legs will have levelers. This will create a "wheelbarrow" style of table which will ensure ease of mobility.
\$ 1,381	* Color of the Caster Option must be specified at the time of order.
\$ 938	
\$ 1,469	
\$ 938	
\$ 1,469	
\$ 1,069	
\$ 1,225	
\$ 1,750	
\$ 1,225	
\$ 1,750	

Edge Option:

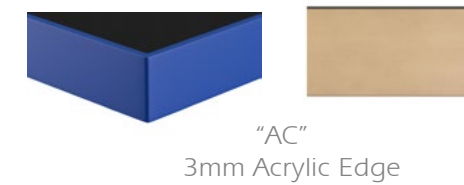

"AC"
3mm Acrylic Edge

Metal Leg Options:

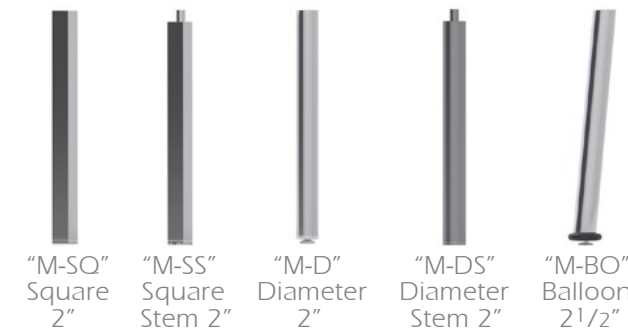

"M-SQ" Square 2"
"M-SS" Square Stem 2"
"M-D" Diameter 2"
"M-DS" Diameter Stem 2"
"M-BO" Balloon 2 1/2"

Wood Leg Options:

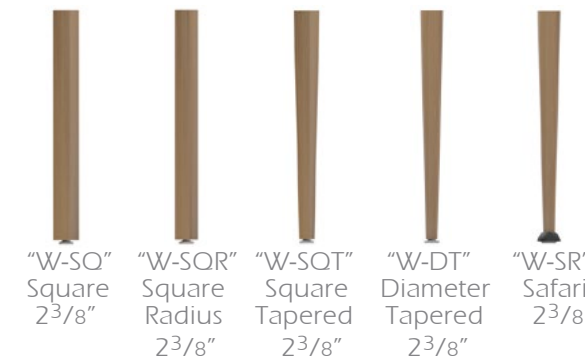

"W-SQ" Square 2 3/8"
"W-SQR" Square Radius 2 3/8"
"W-SQT" Square Tapered 2 3/8"
"W-DT" Diameter Tapered 2 3/8"
"W-SR" Safari 2 3/8"



"MC" Caster Option:
Available on all Metal Legs ONLY, with exception of the Balloon leg and Metal Bases.

MODEL NUMBER	PRODUCT	WIDTH	DEPTH	HEIGHT
--------------	---------	-------	-------	--------



*Shown Above:
TB-3030-SQ-M-D



*Square Table Shape

	Square Table, 30" Width, SQUARE Edge;	30"	30"	29"
	with WOOD Leg Option:	30"	30"	29"
TB-3030-SQ-W-SQ	Square			
TB-3030-SQ-W-SQR	Square Radius			
TB-3030-SQ-W-SQT	Square Tapered			
TB-3030-SQ-W-DT	Diameter Tapered			
TB-3030-SQ-W-SR	Safari			
	with METAL Leg Option:	30"	30"	29"
TB-3030-SQ-M-SQ	Square			
TB-3030-SQ-M-SS	Square & Stem			
TB-3030-SQ-M-D	Diameter			
TB-3030-SQ-M-DS	Diameter & Stem			
TB-3030-SQ-M-BO	Balloon			
TB-3030-SQ-MC-SQ	Square with Casters			
TB-3030-SQ-MC-SS	Square & Stem with Casters			
TB-3030-SQ-MC-D	Diameter with Casters			
TB-3030-SQ-MC-DS	Diameter & Stem with Casters			

PRICE	DESCRIPTION
-------	-------------

	Each Table Top is constructed using a 1 1/8" thick top with a Plastic Laminate top surface.
	All Metal legs are coated electrostatically with an epoxy powder coat paint.
	NOTES:
\$ 1,131	* Table heights of 25" (children), 27" (youth), and 32" (wheelchair) are available by request.
\$ 1,131	* Color of Metal Paint must be specified at the time of order.
\$ 1,325	* Caster Leg options are recommended for Reading/Multipurpose Tables options and not meant to be used for stationary computer workstations.
\$ 1,488	* For all tables with casters legs, only 2 legs will have casters, and the other legs will have levelers. This will create a "wheelbarrow" style of table which will ensure ease of mobility.
\$ 1,494	* Color of the Caster Option must be specified at the time of order.
\$ 1,050	
\$ 1,588	
\$ 1,050	
\$ 1,588	
\$ 1,181	
\$ 1,338	
\$ 1,863	
\$ 1,338	
\$ 1,863	

Edge Option:



"SQ"
1/4" Square Edge

Metal Leg Options:



"M-SQ" Square 2"
"M-SS" Square Stem 2"
"M-D" Diameter 2"
"M-DS" Diameter Stem 2"
"M-BO" Balloon 2 1/2"

Wood Leg Options:



"W-SQ" Square 2 3/8"
"W-SQR" Square Radius 2 3/8"
"W-SQT" Square Tapered 2 3/8"
"W-DT" Diameter Tapered 2 3/8"
"W-SR" Safari 2 3/8"



Black/Black
White/Grey
Silver/Orange
Mirror Finish/Grey

"MC" Caster Option:
Available on all Metal Legs ONLY, with exception of the Balloon leg and Metal Bases.

MODEL NUMBER	PRODUCT	WIDTH	DEPTH	HEIGHT
--------------	---------	-------	-------	--------

	Square Table, 30" Width,	30"	30"	29"
--	--------------------------	-----	-----	-----

	DROPPED SQUARE Edge;			
--	----------------------	--	--	--

	with WOOD Leg Option:	30"	30"	29"
--	-----------------------	-----	-----	-----

TB-3030-DSQ-W-SQ	Square
TB-3030-DSQ-W-SQR	Square Radius
TB-3030-DSQ-W-SQT	Square Tapered
TB-3030-DSQ-W-DT	Diameter Tapered
TB-3030-DSQ-W-SR	Safari

	with METAL Leg Option:	30"	30"	29"
--	------------------------	-----	-----	-----

TB-3030-DSQ-M-SQ	Square
TB-3030-DSQ-M-SS	Square & Stem
TB-3030-DSQ-M-D	Diameter
TB-3030-DSQ-M-DS	Diameter & Stem
TB-3030-DSQ-M-BO	Balloon
TB-3030-DSQ-MC-SQ	Square with Casters
TB-3030-DSQ-MC-SS	Square & Stem with Casters
TB-3030-DSQ-MC-D	Diameter with Casters
TB-3030-DSQ-MC-DS	Diameter & Stem with Casters

PRICE	DESCRIPTION
-------	-------------

\$ 1,213	
\$ 1,213	
\$ 1,406	
\$ 1,569	
\$ 1,575	

\$ 1,131	
\$ 1,663	
\$ 1,131	
\$ 1,663	
\$ 1,263	
\$ 1,419	
\$ 1,944	
\$ 1,419	
\$ 1,944	

Each Table Top is constructed using a 1 1/8" thick top with a Plastic Laminate top surface.

All Metal legs are coated electrostatically with an epoxy powder coat paint.

NOTES:

- * Table heights of 25" (children), 27" (youth), and 32" (wheelchair) are available by request.
- * Color of Metal Paint must be specified at the time of order.
- * Caster Leg options are recommended for Reading/Multipurpose Tables options and not meant to be used for stationary computer workstations.
- * For all tables with casters legs, only 2 legs will have casters, and the other legs will have levelers. This will create a "wheelbarrow" style of table which will ensure ease of mobility.
- * Color of the Caster Option must be specified at the time of order.

Edge Option:



Metal Leg Options:

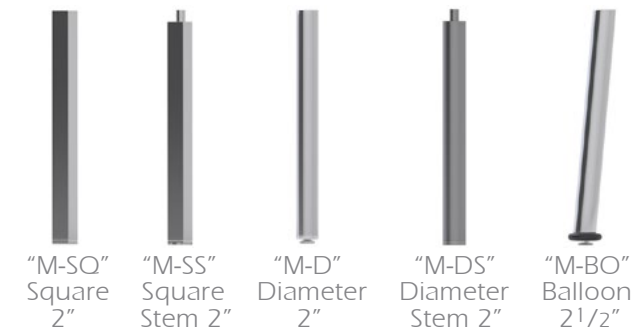

Wood Leg Options:

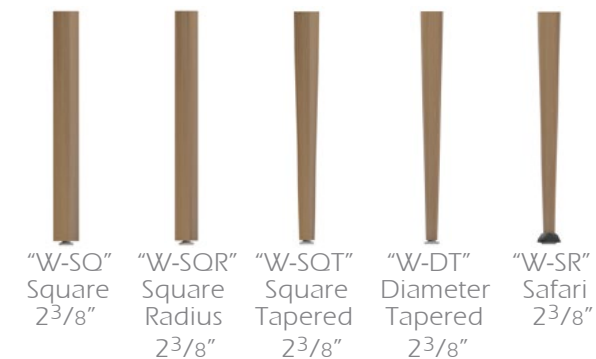

"MC" Caster Option:
Available on all Metal Legs ONLY, with exception of the Balloon leg and Metal Bases.



*Shown Above:
TB-3030-DSQ-M-D



*Square Table Shape

MODEL NUMBER	PRODUCT	WIDTH	DEPTH	HEIGHT
--------------	---------	-------	-------	--------

	Square Table, 30" Width,	30"	30"	29"
--	--------------------------	-----	-----	-----

DROPPED BULLNOSE Edge;

	with WOOD Leg Option:	30"	30"	29"
--	-----------------------	-----	-----	-----

TB-3030-DBN-W-SQ
 TB-3030-DBN-W-SQR
 TB-3030-DBN-W-SQT
 TB-3030-DBN-W-DT
 TB-3030-DBN-W-SR

Square
 Square Radius
 Square Tapered
 Diameter Tapered
 Safari

	with METAL Leg Option:	30"	30"	29"
--	------------------------	-----	-----	-----

TB-3030-DBN-M-SQ
 TB-3030-DBN-M-SS
 TB-3030-DBN-M-D
 TB-3030-DBN-M-DS
 TB-3030-DBN-M-BO
 TB-3030-DBN-MC-SQ
 TB-3030-DBN-MC-SS
 TB-3030-DBN-MC-D
 TB-3030-DBN-MC-DS

Square
 Square & Stem
 Diameter
 Diameter & Stem
 Balloon
 Square with Casters
 Square & Stem with Casters
 Diameter with Casters
 Diameter & Stem with Casters



*Shown Above:
TB-3030-DBN-M-D



*Square Table Shape

PRICE	DESCRIPTION
-------	-------------

Each Table Top is constructed using a 1 1/8" thick top with a Plastic Laminate top surface.

All Metal legs are coated electrostatically with an epoxy powder coat paint.

NOTES:
 * Table heights of 25" (children), 27" (youth), and 32" (wheelchair) are available by request.
 * Color of Metal Paint must be specified at the time of order.
 * Caster Leg options are recommended for Reading/Multipurpose Tables options and not meant to be used for stationary computer workstations.
 * For all tables with casters legs, only 2 legs will have casters, and the other legs will have levelers. This will create a "wheelbarrow" style of table which will ensure ease of mobility.
 * Color of the Caster Option must be specified at the time of order.

\$ 1,231	
\$ 1,231	
\$ 1,419	
\$ 1,581	
\$ 1,588	
\$ 1,150	
\$ 1,681	
\$ 1,150	
\$ 1,681	
\$ 1,275	
\$ 1,431	
\$ 1,963	
\$ 1,431	
\$ 1,963	

Edge Option:



"DBN"

3/4" Dropped Bullnoses Edge

Metal Leg Options:



"M-SQ" Square 2"
 "M-SS" Square Stem 2"
 "M-D" Diameter 2"
 "M-DS" Diameter Stem 2"
 "M-BO" Balloon 2 1/2"

Wood Leg Options:



"W-SQ" Square 2 3/8"
 "W-SQR" Square Radius 2 3/8"
 "W-SQT" Square Tapered 2 3/8"
 "W-DT" Diameter Tapered 2 3/8"
 "W-SR" Safari 2 3/8"



Black/Black White/Grey Silver/Orange Mirror Finish/Grey

"MC" Caster Option:
 Available on all Metal Legs ONLY, with exception of the Balloon leg and Metal Bases.

MODEL NUMBER	PRODUCT	WIDTH	DEPTH	HEIGHT
--------------	---------	-------	-------	--------

	Square Table, 30" Width,	30"	30"	29"
--	--------------------------	-----	-----	-----

DROPPED CHAMFERED Edge;

	with WOOD Leg Option:	30"	30"	29"
--	-----------------------	-----	-----	-----

TB-3030-DCH-W-SQ
 TB-3030-DCH-W-SQR
 TB-3030-DCH-W-SQT
 TB-3030-DCH-W-DT
 TB-3030-DCH-W-SR

Square
 Square Radius
 Square Tapered
 Diameter Tapered
 Safari

	with METAL Leg Option:	30"	30"	29"
--	------------------------	-----	-----	-----

TB-3030-DCH-M-SQ
 TB-3030-DCH-M-SS
 TB-3030-DCH-M-D
 TB-3030-DCH-M-DS
 TB-3030-DCH-M-BO
 TB-3030-DCH-MC-SQ
 TB-3030-DCH-MC-SS
 TB-3030-DCH-MC-D
 TB-3030-DCH-MC-DS

Square
 Square & Stem
 Diameter
 Diameter & Stem
 Balloon
 Square with Casters
 Square & Stem with Casters
 Diameter with Casters
 Diameter & Stem with Casters



*Shown Above:
TB-3030-DCH-M-D



*Square Table Shape

PRICE	DESCRIPTION
-------	-------------

Each Table Top is constructed using a 1 1/8" thick top with a Plastic Laminate top surface.

All Metal legs are coated electrostatically with an epoxy powder coat paint.

NOTES:
 * Table heights of 25" (children), 27" (youth), and 32" (wheelchair) are available by request.
 * Color of Metal Paint must be specified at the time of order.
 * Caster Leg options are recommended for Reading/Multipurpose Tables options and not meant to be used for stationary computer workstations.
 * For all tables with casters legs, only 2 legs will have casters, and the other legs will have levelers. This will create a "wheelbarrow" style of table which will ensure ease of mobility.
 * Color of the Caster Option must be specified at the time of order.

\$ 1,231	
\$ 1,231	
\$ 1,419	
\$ 1,581	
\$ 1,588	
\$ 1,150	
\$ 1,681	
\$ 1,150	
\$ 1,681	
\$ 1,275	
\$ 1,431	
\$ 1,963	
\$ 1,431	
\$ 1,963	

Edge Option:



"DCH"
5/8" Dropped Chamfered Edge

Metal Leg Options:



"M-SQ" Square 2"
 "M-SS" Square Stem 2"
 "M-D" Diameter 2"
 "M-DS" Diameter Stem 2"
 "M-BO" Balloon 2 1/2"

Wood Leg Options:



"W-SQ" Square 2 3/8"
 "W-SQR" Square Radius 2 3/8"
 "W-SQT" Square Tapered 2 3/8"
 "W-DT" Diameter Tapered 2 3/8"
 "W-SR" Safari 2 3/8"

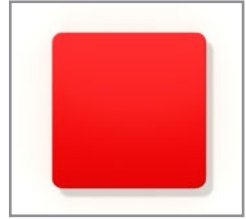

"MC" Caster Option:
 Available on all Metal Legs ONLY, with exception of the Balloon leg and Metal Bases.

MODEL NUMBER	PRODUCT	WIDTH	DEPTH	HEIGHT
 *Shown Above: TB-3030-AL-M-D	Square Table, 30" Width, ALUMINUM Edge;	30"	30"	29"
	with WOOD Leg Option:	30"	30"	29"
	TB-3030-AL-W-SQ Square			
	TB-3030-AL-W-SQR Square Radius			
	TB-3030-AL-W-SQT Square Tapered			
TB-3030-AL-W-DT Diameter Tapered				
TB-3030-AL-W-SR Safari				
 *Square Table Shape	with METAL Leg Option:	30"	30"	29"
	TB-3030-AL-M-SQ Square			
	TB-3030-AL-M-SS Square & Stem			
	TB-3030-AL-M-D Diameter			
	TB-3030-AL-M-DS Diameter & Stem			
	TB-3030-AL-M-BO Balloon			
	TB-3030-AL-MC-SQ Square with Casters			
	TB-3030-AL-MC-SS Square & Stem with Casters			
	TB-3030-AL-MC-D Diameter with Casters			
	TB-3030-AL-MC-DS Diameter & Stem with Casters			

PRICE

\$ 1,088
\$ 1,088
\$ 1,275
\$ 1,438
\$ 1,450

\$ 1,006
\$ 1,538
\$ 1,006
\$ 1,538
\$ 1,131
\$ 1,288
\$ 1,819
\$ 1,288
\$ 1,819

DESCRIPTION

Each Table Top is constructed using a 1 1/8" thick top with a Plastic Laminate top surface.

All Metal legs are coated electrostatically with an epoxy powder coat paint.

NOTES:

- * Table heights of 25" (children), 27" (youth), and 32" (wheelchair) are available by request.
- * Color of Metal Paint must be specified at the time of order.
- * Caster Leg options are recommended for Reading/Multipurpose Tables options and not meant to be used for stationary computer workstations.
- * For all tables with casters legs, only 2 legs will have casters, and the other legs will have levelers. This will create a "wheelbarrow" style of table which will ensure ease of mobility.
- * Color of the Caster Option must be specified at the time of order.

Edge Option:



"AL"

3mm Aluminum Edge

*All table corners will be given a 6-inch radius for this edge option.

Metal Leg Options:



"M-SQ" Square 2"
"M-SS" Square Stem 2"
"M-D" Diameter 2"
"M-DS" Diameter Stem 2"
"M-BO" Balloon 2 1/2"

Wood Leg Options:



"W-SQ" Square 2 3/8"
"W-SQR" Square Radius 2 3/8"
"W-SQT" Square Tapered 2 3/8"
"W-DT" Diameter Tapered 2 3/8"
"W-SR" Safari 2 3/8"



"MC" Caster Option:

Available on all Metal Legs ONLY, with exception of the Balloon leg and Metal Bases.

MODEL NUMBER

PRODUCT

WIDTH DEPTH HEIGHT

PRICE

DESCRIPTION



*Shown Above:
TB-3636-AC-M-D



*Square Table Shape

- TB-3636-AC-W-SQ
- TB-3636-AC-W-SQR
- TB-3636-AC-W-SQT
- TB-3636-AC-W-DT
- TB-3636-AC-W-SR

Square Table, 36" Width,
ACRYLIC Edge;
with WOOD Leg Option:
Square
Square Radius
Square Tapered
Diameter Tapered
Safari

36" 36" 29"

- \$ 1,069
- \$ 1,069
- \$ 1,256
- \$ 1,419
- \$ 1,425

- TB-3636-AC-M-SQ
- TB-3636-AC-M-SS
- TB-3636-AC-M-D
- TB-3636-AC-M-DS
- TB-3636-AC-M-BO
- TB-3636-AC-MC-SQ
- TB-3636-AC-MC-SS
- TB-3636-AC-MC-D
- TB-3636-AC-MC-DS

with METAL Leg Option:
Square
Square & Stem
Diameter
Diameter & Stem
Balloon
Square with Casters
Square & Stem with Casters
Diameter with Casters
Diameter & Stem with Casters

36" 36" 29"

- \$ 988
- \$ 1,513
- \$ 988
- \$ 1,519
- \$ 1,113
- \$ 1,269
- \$ 1,800
- \$ 1,269
- \$ 1,800

- TB-3636-AC-FP1
- TB-3636-AC-FP2
- TB-3636-AC-FP3
- TB-3636-AC-TP1
- TB-3636-AC-TP2
- TB-3636-AC-TP3

Flat Pedestal 19" H
Flat Pedestal 29" H
Flat Pedestal 42" H
Trumpet 19" H
Trumpet 29" H
Trumpet 42" H

36" 36" 19"
36" 36" 29"
36" 36" 42"
36" 36" 19"
36" 36" 29"
36" 36" 42"

- \$ 1,438
- \$ 1,438
- \$ 1,675
- \$ 1,094
- \$ 1,094
- \$ 1,550

Each Table Top is constructed using a 1" thick top with a Plastic Laminate top surface.

All Metal legs are coated electrostatically with an epoxy powder coat paint.

NOTES:

- * Table heights of 25" (children), 27" (youth), and 32" (wheelchair) are available by request.
- * Color of Metal Paint must be specified at the time of order.
- * Caster Leg options are recommended for Reading/Multipurpose Tables options and not meant to be used for stationary computer workstations.
- * For all tables with casters legs, only 2 legs will have casters, and the other legs will have levelers. This will create a "wheelbarrow" style of table which will ensure ease of mobility.
- * Color of the Caster Option must be specified at the time of order.

Edge Option:



"AC"
3mm Acrylic Edge

Metal Leg Options:

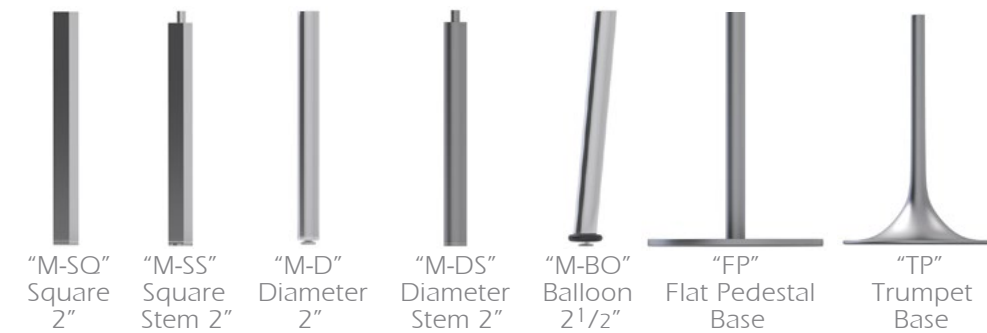

"M-SQ" Square 2"
"M-SS" Square Stem 2"
"M-D" Diameter 2"
"M-DS" Diameter Stem 2"
"M-BO" Balloon 2 1/2"
"FP" Flat Pedestal Base
"TP" Trumpet Base

Wood Leg Options:

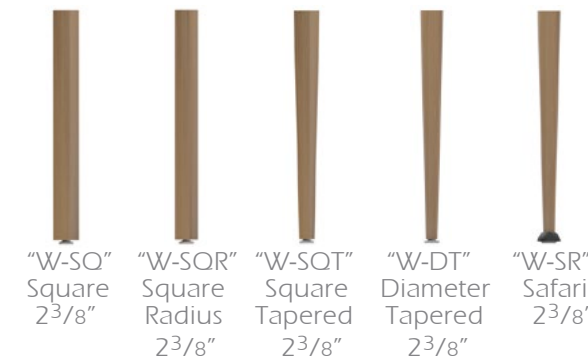

"W-SQ" Square 2 3/8"
"W-SQR" Square Radius 2 3/8"
"W-SQT" Square Tapered 2 3/8"
"W-DT" Diameter Tapered 2 3/8"
"W-SR" Safari 2 3/8"



"MC" Caster Option:
Available on all Metal Legs ONLY, with exception of the Balloon leg and Metal Bases.

MODEL NUMBER

PRODUCT

WIDTH DEPTH HEIGHT

PRICE

DESCRIPTION



*Shown Above:
TB-3636-SQ-M-D



*Square Table Shape

- TB-3636-SQ-W-SQ
- TB-3636-SQ-W-SQR
- TB-3636-SQ-W-SQT
- TB-3636-SQ-W-DT
- TB-3636-SQ-W-SR

Square Table, 36" Width,
SQUARE Edge;
with WOOD Leg Option:
Square
Square Radius
Square Tapered
Diameter Tapered
Safari

36" 36" 29"

- \$ 1,213
- \$ 1,213
- \$ 1,400
- \$ 1,563
- \$ 1,569

- TB-3636-SQ-M-SQ
- TB-3636-SQ-M-SS
- TB-3636-SQ-M-D
- TB-3636-SQ-M-DS
- TB-3636-SQ-M-BO
- TB-3636-SQ-MC-SQ
- TB-3636-SQ-MC-SS
- TB-3636-SQ-MC-D
- TB-3636-SQ-MC-DS

with METAL Leg Option:
Square
Square & Stem
Diameter
Diameter & Stem
Balloon
Square with Casters
Square & Stem with Casters
Diameter with Casters
Diameter & Stem with Casters

36" 36" 29"

- \$ 1,131
- \$ 1,663
- \$ 1,131
- \$ 1,663
- \$ 1,256
- \$ 1,406
- \$ 1,944
- \$ 1,406
- \$ 1,944

Each Table Top is constructed using a 1 1/8" thick top with a Plastic Laminate top surface.

All Metal legs are coated electrostatically with an epoxy powder coat paint.

NOTES:

- * Table heights of 25" (children), 27" (youth), and 32" (wheelchair) are available by request.
- * Color of Metal Paint must be specified at the time of order.
- * Caster Leg options are recommended for Reading/Multipurpose Tables options and not meant to be used for stationary computer workstations.
- * For all tables with casters legs, only 2 legs will have casters, and the other legs will have levelers. This will create a "wheelbarrow" style of table which will ensure ease of mobility.
- * Color of the Caster Option must be specified at the time of order.

Edge Option:



"SQ"
1/4" Square Edge

Metal Leg Options:

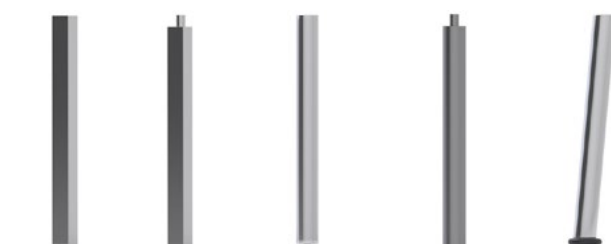

"M-SQ" Square 2"
"M-SS" Square Stem 2"
"M-D" Diameter 2"
"M-DS" Diameter Stem 2"
"M-BO" Balloon 2 1/2"

Wood Leg Options:



"W-SQ" Square 2 3/8"
"W-SQR" Square Radius 2 3/8"
"W-SQT" Square Tapered 2 3/8"
"W-DT" Diameter Tapered 2 3/8"
"W-SR" Safari 2 3/8"



Black/Black White/Grey Silver/Orange Mirror Finish/Grey

"MC" Caster Option:
Available on all Metal Legs ONLY, with exception of the Balloon leg and Metal Bases.

MODEL NUMBER	PRODUCT	WIDTH	DEPTH	HEIGHT
--------------	---------	-------	-------	--------

	Square Table, 36" Width,	36"	36"	29"
--	--------------------------	-----	-----	-----

	DROPPED SQUARE Edge;			
--	----------------------	--	--	--

	with WOOD Leg Option:	36"	36"	29"
--	-----------------------	-----	-----	-----

TB-3636-DSQ-W-SQ	Square
TB-3636-DSQ-W-SQR	Square Radius
TB-3636-DSQ-W-SQT	Square Tapered
TB-3636-DSQ-W-DT	Diameter Tapered
TB-3636-DSQ-W-SR	Safari

	with METAL Leg Option:	36"	36"	29"
--	------------------------	-----	-----	-----

TB-3636-DSQ-M-SQ	Square
TB-3636-DSQ-M-SS	Square & Stem
TB-3636-DSQ-M-D	Diameter
TB-3636-DSQ-M-DS	Diameter & Stem
TB-3636-DSQ-M-BO	Balloon
TB-3636-DSQ-MC-SQ	Square with Casters
TB-3636-DSQ-MC-SS	Square & Stem with Casters
TB-3636-DSQ-MC-D	Diameter with Casters
TB-3636-DSQ-MC-DS	Diameter & Stem with Casters



*Shown Above:
TB-3636-DSQ-M-D



*Square Table Shape

PRICE	DESCRIPTION
-------	-------------

\$ 1,281	Each Table Top is constructed using a 1 1/8" thick top with a Plastic Laminate top surface.
----------	---

\$ 1,281	All Metal legs are coated electrostatically with an epoxy powder coat paint.
----------	--

\$ 1,281	NOTES:
\$ 1,463	* Table heights of 25" (children), 27" (youth), and 32" (wheelchair) are available by request.
\$ 1,631	* Color of Metal Paint must be specified at the time of order.
\$ 1,644	* Caster Leg options are recommended for Reading/Multipurpose Tables options and not meant to be used for stationary computer workstations.
	* For all tables with casters legs, only 2 legs will have casters, and the other legs will have levelers. This will create a "wheelbarrow" style of table which will ensure ease of mobility.
	* Color of the Caster Option must be specified at the time of order.

\$ 1,200
\$ 1,731
\$ 1,200
\$ 1,731
\$ 1,331
\$ 1,481
\$ 2,013
\$ 1,481
\$ 2,013

Edge Option:



"DSQ"
3/4" Dropped Square Edge

Metal Leg Options:

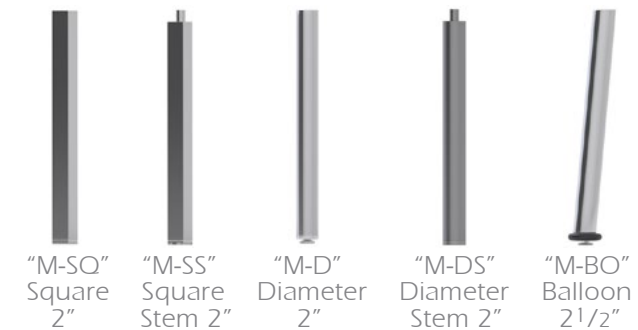

Wood Leg Options:

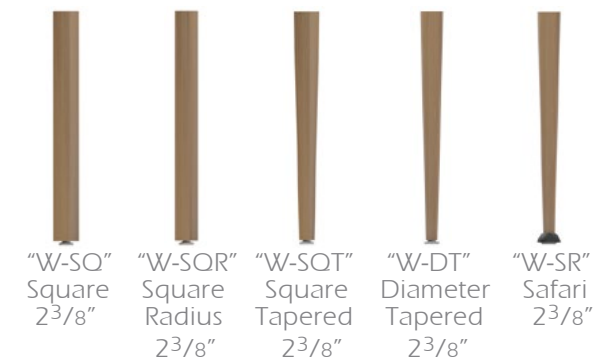

"MC" Caster Option:
Available on all Metal Legs ONLY, with exception of the Balloon leg and Metal Bases.

MODEL NUMBER

PRODUCT

WIDTH DEPTH HEIGHT

PRICE

DESCRIPTION



*Shown Above:
TB-3636-DBN-M-D



*Square Table Shape

- TB-3636-DBN-W-SQ
- TB-3636-DBN-W-SQR
- TB-3636-DBN-W-SQT
- TB-3636-DBN-W-DT
- TB-3636-DBN-W-SR

Square Table, 36" Width,
DROPPED BULLNOSE Edge;
with WOOD Leg Option:
Square
Square Radius
Square Tapered
Diameter Tapered
Safari

36" 36" 29"
36" 36" 29"

- \$ 1,294
- \$ 1,294
- \$ 1,488
- \$ 1,644
- \$ 1,656

NOTES:

- * Each Table Top is constructed using a 1 1/8" thick top with a Plastic Laminate top surface.
- * All Metal legs are coated electrostatically with an epoxy powder coat paint.
- * Table heights of 25" (children), 27" (youth), and 32" (wheelchair) are available by request.
- * Color of Metal Paint must be specified at the time of order.
- * Caster Leg options are recommended for Reading/Multipurpose Tables options and not meant to be used for stationary computer workstations.
- * For all tables with casters legs, only 2 legs will have casters, and the other legs will have levelers. This will create a "wheelbarrow" style of table which will ensure ease of mobility.
- * Color of the Caster Option must be specified at the time of order.

with METAL Leg Option:
Square
Square & Stem
Diameter
Diameter & Stem
Balloon
Square with Casters
Square & Stem with Casters
Diameter with Casters
Diameter & Stem with Casters

36" 36" 29"

- \$ 1,213
- \$ 1,744
- \$ 1,213
- \$ 1,744
- \$ 1,344
- \$ 1,494
- \$ 2,025
- \$ 1,494
- \$ 2,025

Edge Option:



"DBN"
3/4" Dropped Bullnoses Edge

Metal Leg Options:



"M-SQ" Square 2"
"M-SS" Square Stem 2"
"M-D" Diameter 2"
"M-DS" Diameter Stem 2"
"M-BO" Balloon 2 1/2"

Wood Leg Options:



"W-SQ" Square 2 3/8"
"W-SQR" Square Radius 2 3/8"
"W-SQT" Square Tapered 2 3/8"
"W-DT" Diameter Tapered 2 3/8"
"W-SR" Safari 2 3/8"



Black/Black White/Grey Silver/Orange Mirror Finish/Grey

"MC" Caster Option:
Available on all Metal Legs ONLY, with exception of the Balloon leg and Metal Bases.

MODEL NUMBER

PRODUCT

WIDTH DEPTH HEIGHT

PRICE

DESCRIPTION



*Shown Above:
TB-3636-DCH-M-D



*Square Table Shape

- TB-3636-DCH-W-SQ
- TB-3636-DCH-W-SQR
- TB-3636-DCH-W-SQT
- TB-3636-DCH-W-DT
- TB-3636-DCH-W-SR

Square Table, 36" Width,
DROPPED CHAMFERED Edge;
with WOOD Leg Option: 36" 36" 29"
Square
Square Radius
Square Tapered
Diameter Tapered
Safari

- TB-3636-DCH-M-SQ
- TB-3636-DCH-M-SS
- TB-3636-DCH-M-D
- TB-3636-DCH-M-DS
- TB-3636-DCH-M-BO
- TB-3636-DCH-MC-SQ
- TB-3636-DCH-MC-SS
- TB-3636-DCH-MC-D
- TB-3636-DCH-MC-DS

with METAL Leg Option: 36" 36" 29"
Square
Square & Stem
Diameter
Diameter & Stem
Balloon
Square with Casters
Square & Stem with Casters
Diameter with Casters
Diameter & Stem with Casters

- \$ 1,294
- \$ 1,294
- \$ 1,488
- \$ 1,644
- \$ 1,656

- \$ 1,213
- \$ 1,744
- \$ 1,213
- \$ 1,744
- \$ 1,344
- \$ 1,494
- \$ 2,025
- \$ 1,494
- \$ 2,025

Each Table Top is constructed using a 1 1/8" thick top with a Plastic Laminate top surface.

All Metal legs are coated electrostatically with an epoxy powder coat paint.

NOTES:

- * Table heights of 25" (children), 27" (youth), and 32" (wheelchair) are available by request.
- * Color of Metal Paint must be specified at the time of order.
- * Caster Leg options are recommended for Reading/Multipurpose Tables options and not meant to be used for stationary computer workstations.
- * For all tables with casters legs, only 2 legs will have casters, and the other legs will have levelers. This will create a "wheelbarrow" style of table which will ensure ease of mobility.
- * Color of the Caster Option must be specified at the time of order.

Edge Option:



"DCH"

5/8" Dropped Chamfered Edge

Metal Leg Options:



- "M-SQ" Square 2"
- "M-SS" Square Stem 2"
- "M-D" Diameter 2"
- "M-DS" Diameter Stem 2"
- "M-BO" Balloon 2 1/2"

Wood Leg Options:



- "W-SQ" Square 2 3/8"
- "W-SQR" Square Radius 2 3/8"
- "W-SQT" Square Tapered 2 3/8"
- "W-DT" Diameter Tapered 2 3/8"
- "W-SR" Safari 2 3/8"



- Black/Black
- White/Grey
- Silver/Orange
- Mirror Finish/Grey

"MC" Caster Option:
Available on all Metal Legs ONLY, with exception of the Balloon leg and Metal Bases.

MODEL NUMBER

PRODUCT

WIDTH DEPTH HEIGHT

PRICE

DESCRIPTION



*Shown Above:
TB-3636-AL-M-D

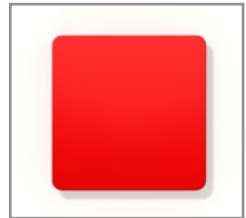

*Square Table Shape

MODEL NUMBER	PRODUCT	WIDTH	DEPTH	HEIGHT	PRICE
	Square Table, 36" Width, ALUMINUM Edge;	36"	36"	29"	
	with WOOD Leg Option:	36"	36"	29"	
TB-3636-AL-W-SQ	Square				\$ 1,150
TB-3636-AL-W-SQR	Square Radius				\$ 1,150
TB-3636-AL-W-SQT	Square Tapered				\$ 1,344
TB-3636-AL-W-DT	Diameter Tapered				\$ 1,506
TB-3636-AL-W-SR	Safari				\$ 1,513
	with METAL Leg Option:	36"	36"	29"	
TB-3636-AL-M-SQ	Square				\$ 1,069
TB-3636-AL-M-SS	Square & Stem				\$ 1,606
TB-3636-AL-M-D	Diameter				\$ 1,069
TB-3636-AL-M-DS	Diameter & Stem				\$ 1,606
TB-3636-AL-M-BO	Balloon				\$ 1,200
TB-3636-AL-MC-SQ	Square with Casters				\$ 1,350
TB-3636-AL-MC-SS	Square & Stem with Casters				\$ 1,881
TB-3636-AL-MC-D	Diameter with Casters				\$ 1,350
TB-3636-AL-MC-DS	Diameter & Stem with Casters				\$ 1,881
TB-3636-AL-FP1	Flat Pedestal 19" H	36"	36"	19"	\$ 1,525
TB-3636-AL-FP2	Flat Pedestal 29" H	36"	36"	29"	\$ 1,663
TB-3636-AL-FP3	Flat Pedestal 42" H	36"	36"	42"	\$ 1,763
TB-3636-AL-TP1	Trumpet 19" H	36"	36"	19"	\$ 1,175
TB-3636-AL-TP2	Trumpet 29" H	36"	36"	29"	\$ 1,175
TB-3636-AL-TP3	Trumpet 42" H	36"	36"	42"	\$ 1,638

Each Table Top is constructed using a 1 1/8" thick top with a Plastic Laminate top surface.

All Metal legs are coated electrostatically with an epoxy powder coat paint.

NOTES:

* Table heights of 25" (children), 27" (youth), and 32" (wheelchair) are available by request.

* Color of Metal Paint must be specified at the time of order.

* Caster Leg options are recommended for Reading/Multipurpose Tables options and not meant to be used for stationary computer workstations.

* For all tables with casters legs, only 2 legs will have casters, and the other legs will have levelers. This will create a "wheelbarrow" style of table which will ensure ease of mobility.

* Color of the Caster Option must be specified at the time of order.

Edge Option:



"AL"
3mm Aluminum Edge *All table corners will be given a 6-inch radius for this edge option.

Metal Leg Options:

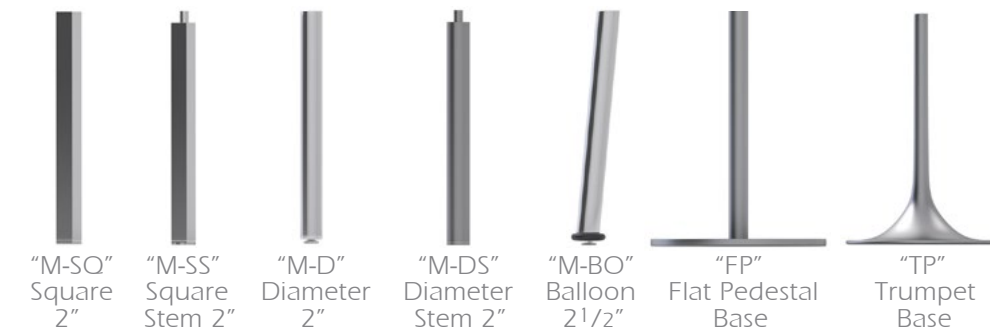

Wood Leg Options:

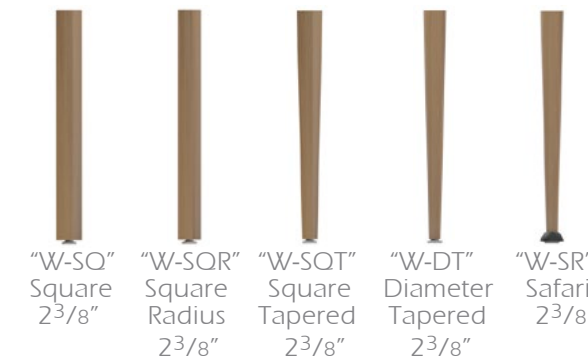

"MC" Caster Option:
Available on all Metal Legs ONLY, with exception of the Balloon leg and Metal Bases.

MODEL NUMBER

PRODUCT

WIDTH DEPTH HEIGHT

PRICE

DESCRIPTION



*Shown Above:
TB-4242-AC-M-D



*Square Table Shape

- TB-4242-AC-W-SQ
- TB-4242-AC-W-SQR
- TB-4242-AC-W-SQT
- TB-4242-AC-W-DT
- TB-4242-AC-W-SR

Square Table, 42" Width,
ACRYLIC Edge;
with WOOD Leg Option:
Square
Square Radius
Square Tapered
Diameter Tapered
Safari

42" 42" 29"

- \$ 1,131
- \$ 1,131
- \$ 1,319
- \$ 1,488
- \$ 1,494

- TB-4242-AC-M-SQ
- TB-4242-AC-M-SS
- TB-4242-AC-M-D
- TB-4242-AC-M-DS
- TB-4242-AC-M-BO
- TB-4242-AC-MC-SQ
- TB-4242-AC-MC-SS
- TB-4242-AC-MC-D
- TB-4242-AC-MC-DS

with METAL Leg Option:
Square
Square & Stem
Diameter
Diameter & Stem
Balloon
Square with Casters
Square & Stem with Casters
Diameter with Casters
Diameter & Stem with Casters

42" 42" 29"

- \$ 1,050
- \$ 1,581
- \$ 1,050
- \$ 1,581
- \$ 1,181
- \$ 1,331
- \$ 1,863
- \$ 1,331
- \$ 1,863

- TB-4242-AC-FP1
- TB-4242-AC-FP2
- TB-4242-AC-FP3
- TB-4242-AC-TP1
- TB-4242-AC-TP2
- TB-4242-AC-TP3

Flat Pedestal 19" H
Flat Pedestal 29" H
Flat Pedestal 42" H
Trumpet 19" H
Trumpet 29" H
Trumpet 42" H

42" 42" 19"
42" 42" 29"
42" 42" 42"
42" 42" 19"
42" 42" 29"
42" 42" 42"

- \$ 1,744
- \$ 1,744
- \$ 1,838
- \$ 1,394
- \$ 1,394
- \$ 1,619

Each Table Top is constructed using a 1" thick top with a Plastic Laminate top surface.

All Metal legs are coated electrostatically with an epoxy powder coat paint.

NOTES:

- * Table heights of 25" (children), 27" (youth), and 32" (wheelchair) are available by request.
- * Color of Metal Paint must be specified at the time of order.
- * Caster Leg options are recommended for Reading/Multipurpose Tables options and not meant to be used for stationary computer workstations.
- * For all tables with casters legs, only 2 legs will have casters, and the other legs will have levelers. This will create a "wheelbarrow" style of table which will ensure ease of mobility.
- * Color of the Caster Option must be specified at the time of order.

Edge Option:

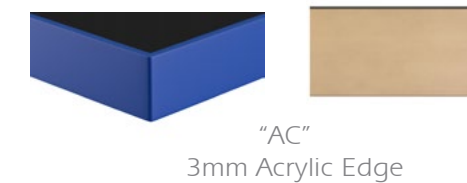

"AC"
3mm Acrylic Edge

Metal Leg Options:



"M-SQ" Square 2"
"M-SS" Square Stem 2"
"M-D" Diameter 2"
"M-DS" Diameter Stem 2"
"M-BO" Balloon 2 1/2"
"FP" Flat Pedestal Base
"TP" Trumpet Base

Wood Leg Options:

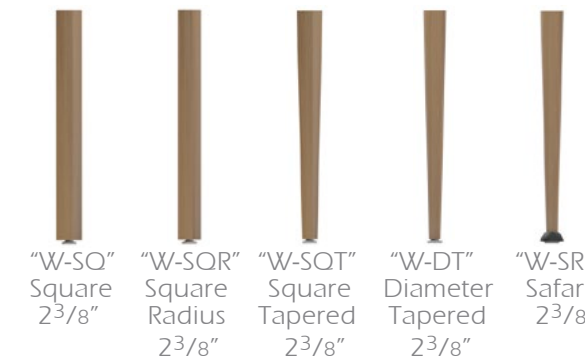

"W-SQ" Square 2 3/8"
"W-SQR" Square Radius 2 3/8"
"W-SQT" Square Tapered 2 3/8"
"W-DT" Diameter Tapered 2 3/8"
"W-SR" Safari 2 3/8"



Black/Black White/Grey Silver/Orange Mirror Finish/Grey

"MC" Caster Option:
Available on all Metal Legs ONLY, with exception of the Balloon leg and Metal Bases.

MODEL NUMBER

PRODUCT

WIDTH DEPTH HEIGHT

PRICE

DESCRIPTION



*Shown Above:
TB-4242-SQ-M-D



*Square Table Shape

- TB-4242-SQ-W-SQ
- TB-4242-SQ-W-SQR
- TB-4242-SQ-W-SQT
- TB-4242-SQ-W-DT
- TB-4242-SQ-W-SR

Square Table, 42" Width,

42" 42" 29"

SQUARE Edge;

with WOOD Leg Option:

42" 42" 29"

- Square
- Square Radius
- Square Tapered
- Diameter Tapered
- Safari

with METAL Leg Option:

42" 42" 29"

- TB-4242-SQ-M-SQ Square
- TB-4242-SQ-M-SS Square & Stem
- TB-4242-SQ-M-D Diameter
- TB-4242-SQ-M-DS Diameter & Stem
- TB-4242-SQ-M-BO Balloon
- TB-4242-SQ-MC-SQ Square with Casters
- TB-4242-SQ-MC-SS Square & Stem with Casters
- TB-4242-SQ-MC-D Diameter with Casters
- TB-4242-SQ-MC-DS Diameter & Stem with Casters

- \$ 1,294
- \$ 1,294
- \$ 1,481
- \$ 1,644
- \$ 1,656

- \$ 1,213
- \$ 1,744
- \$ 1,213
- \$ 1,744
- \$ 1,344
- \$ 1,494
- \$ 2,025
- \$ 1,494
- \$ 2,025

Each Table Top is constructed using a 1 1/8" thick top with a Plastic Laminate top surface.

All Metal legs are coated electrostatically with an epoxy powder coat paint.

NOTES:

- * Table heights of 25" (children), 27" (youth), and 32" (wheelchair) are available by request.
- * Color of Metal Paint must be specified at the time of order.
- * Caster Leg options are recommended for Reading/Multipurpose Tables options and not meant to be used for stationary computer workstations.
- * For all tables with casters legs, only 2 legs will have casters, and the other legs will have levelers. This will create a "wheelbarrow" style of table which will ensure ease of mobility.
- * Color of the Caster Option must be specified at the time of order.

Edge Option:



"SQ"
1/4" Square Edge

Metal Leg Options:



"M-SQ" Square 2"
"M-SS" Square Stem 2"
"M-D" Diameter 2"
"M-DS" Diameter Stem 2"
"M-BO" Balloon 2 1/2"

Wood Leg Options:



"W-SQ" Square 2 3/8"
"W-SQR" Square Radius 2 3/8"
"W-SQT" Square Tapered 2 3/8"
"W-DT" Diameter Tapered 2 3/8"
"W-SR" Safari 2 3/8"



Black/Black White/Grey Silver/Orange Mirror Finish/Grey

"MC" Caster Option:
Available on all Metal Legs ONLY, with exception of the Balloon leg and Metal Bases.

MODEL NUMBER PRODUCT WIDTH DEPTH HEIGHT



*Shown Above:
TB-4242-DSQ-M-D



*Square Table Shape

MODEL NUMBER	PRODUCT	WIDTH	DEPTH	HEIGHT
	Square Table, 42" Width, DROPPED SQUARE Edge;	42"	42"	29"
	with WOOD Leg Option:	42"	42"	29"
TB-4242-DSQ-W-SQ	Square			
TB-4242-DSQ-W-SQR	Square Radius			
TB-4242-DSQ-W-SQT	Square Tapered			
TB-4242-DSQ-W-DT	Diameter Tapered			
TB-4242-DSQ-W-SR	Safari			
	with METAL Leg Option:	42"	42"	29"
TB-4242-DSQ-M-SQ	Square			
TB-4242-DSQ-M-SS	Square & Stem			
TB-4242-DSQ-M-D	Diameter			
TB-4242-DSQ-M-DS	Diameter & Stem			
TB-4242-DSQ-M-BO	Balloon			
TB-4242-DSQ-MC-SQ	Square with Casters			
TB-4242-DSQ-MC-SS	Square & Stem with Casters			
TB-4242-DSQ-MC-D	Diameter with Casters			
TB-4242-DSQ-MC-DS	Diameter & Stem with Casters			

PRICE DESCRIPTION

	Each Table Top is constructed using a 1 1/8" thick top with a Plastic Laminate top surface.
	All Metal legs are coated electrostatically with an epoxy powder coat paint.
	NOTES:
\$ 1,375	* Table heights of 25" (children), 27" (youth), and 32" (wheelchair) are available by request.
\$ 1,375	* Color of Metal Paint must be specified at the time of order.
\$ 1,569	* Caster Leg options are recommended for Reading/Multipurpose Tables options and not meant to be used for stationary computer workstations.
\$ 1,725	* For all tables with casters legs, only 2 legs will have casters, and the other legs will have levelers. This will create a "wheelbarrow" style of table which will ensure ease of mobility.
\$ 1,738	* Color of the Caster Option must be specified at the time of order.

Edge Option:



Metal Leg Options:

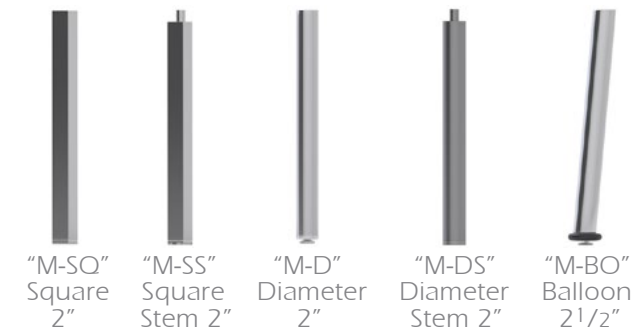

Wood Leg Options:

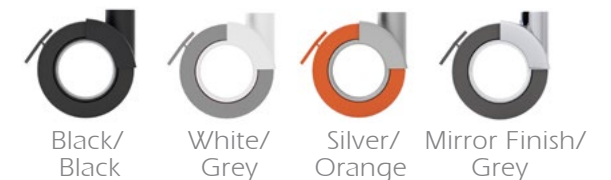
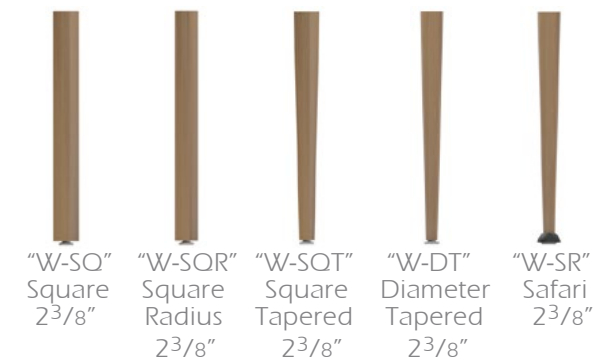

"MC" Caster Option:
Available on all Metal Legs ONLY, with exception of the Balloon leg and Metal Bases.

MODEL NUMBER PRODUCT WIDTH DEPTH HEIGHT



*Shown Above:
TB-4242-DBN-M-D



*Square Table Shape

MODEL NUMBER	PRODUCT	WIDTH	DEPTH	HEIGHT
	Square Table, 42" Width, DROPPED BULLNOSE Edge;	42"	42"	29"
	with WOOD Leg Option:	42"	42"	29"
TB-4242-DBN-W-SQ	Square			
TB-4242-DBN-W-SQR	Square Radius			
TB-4242-DBN-W-SQT	Square Tapered			
TB-4242-DBN-W-DT	Diameter Tapered			
TB-4242-DBN-W-SR	Safari			
	with METAL Leg Option:	42"	42"	29"
TB-4242-DBN-M-SQ	Square			
TB-4242-DBN-M-SS	Square & Stem			
TB-4242-DBN-M-D	Diameter			
TB-4242-DBN-M-DS	Diameter & Stem			
TB-4242-DBN-M-BO	Balloon			
TB-4242-DBN-MC-SQ	Square with Casters			
TB-4242-DBN-MC-SS	Square & Stem with Casters			
TB-4242-DBN-MC-D	Diameter with Casters			
TB-4242-DBN-MC-DS	Diameter & Stem with Casters			

PRICE DESCRIPTION

Each Table Top is constructed using a 1 1/8" thick top with a Plastic Laminate top surface.

All Metal legs are coated electrostatically with an epoxy powder coat paint.

NOTES:
 * Table heights of 25" (children), 27" (youth), and 32" (wheelchair) are available by request.
 * Color of Metal Paint must be specified at the time of order.
 * Caster Leg options are recommended for Reading/Multipurpose Tables options and not meant to be used for stationary computer workstations.
 * For all tables with casters legs, only 2 legs will have casters, and the other legs will have levelers. This will create a "wheelbarrow" style of table which will ensure ease of mobility.
 * Color of the Caster Option must be specified at the time of order.

\$ 1,388
 \$ 1,388
 \$ 1,581
 \$ 1,744
 \$ 1,750

\$ 1,306
 \$ 1,844
 \$ 1,306
 \$ 1,844
 \$ 1,438
 \$ 1,594
 \$ 2,119
 \$ 1,594
 \$ 2,119

Edge Option:



"DBN"

3/4" Dropped Bullnoses Edge

Metal Leg Options:



"M-SQ" Square 2"
 "M-SS" Square Stem 2"
 "M-D" Diameter 2"
 "M-DS" Diameter Stem 2"
 "M-BO" Balloon 2 1/2"

Wood Leg Options:



"W-SQ" Square 2 3/8"
 "W-SQR" Square Radius 2 3/8"
 "W-SQT" Square Tapered 2 3/8"
 "W-DT" Diameter Tapered 2 3/8"
 "W-SR" Safari 2 3/8"



Black/Black White/Grey Silver/Orange Mirror Finish/Grey

"MC" Caster Option:
 Available on all Metal Legs ONLY, with exception of the Balloon leg and Metal Bases.

MODEL NUMBER	PRODUCT	WIDTH	DEPTH	HEIGHT
--------------	---------	-------	-------	--------

	Square Table, 42" Width,	42"	42"	29"
--	--------------------------	-----	-----	-----

DROPPED CHAMFERED Edge;

	with WOOD Leg Option:	42"	42"	29"
--	-----------------------	-----	-----	-----

TB-4242-DCH-W-SQ	Square
TB-4242-DCH-W-SQR	Square Radius
TB-4242-DCH-W-SQT	Square Tapered
TB-4242-DCH-W-DT	Diameter Tapered
TB-4242-DCH-W-SR	Safari

	with METAL Leg Option:	42"	42"	29"
--	------------------------	-----	-----	-----

TB-4242-DCH-M-SQ	Square
TB-4242-DCH-M-SS	Square & Stem
TB-4242-DCH-M-D	Diameter
TB-4242-DCH-M-DS	Diameter & Stem
TB-4242-DCH-M-BO	Balloon
TB-4242-DCH-MC-SQ	Square with Casters
TB-4242-DCH-MC-SS	Square & Stem with Casters
TB-4242-DCH-MC-D	Diameter with Casters
TB-4242-DCH-MC-DS	Diameter & Stem with Casters

PRICE	DESCRIPTION
-------	-------------

\$ 1,388	
\$ 1,388	
\$ 1,581	
\$ 1,744	
\$ 1,750	

\$ 1,306	
\$ 1,844	
\$ 1,306	
\$ 1,844	
\$ 1,438	
\$ 1,594	
\$ 2,119	
\$ 1,594	
\$ 2,119	

Each Table Top is constructed using a 1 1/8" thick top with a Plastic Laminate top surface.

All Metal legs are coated electrostatically with an epoxy powder coat paint.

NOTES:

- * Table heights of 25" (children), 27" (youth), and 32" (wheelchair) are available by request.
- * Color of Metal Paint must be specified at the time of order.
- * Caster Leg options are recommended for Reading/Multipurpose Tables options and not meant to be used for stationary computer workstations.
- * For all tables with casters legs, only 2 legs will have casters, and the other legs will have levelers. This will create a "wheelbarrow" style of table which will ensure ease of mobility.
- * Color of the Caster Option must be specified at the time of order.

Edge Option:



"DCH"
5/8" Dropped Chamfered Edge

Metal Leg Options:



"M-SQ" Square 2"
"M-SS" Square Stem 2"
"M-D" Diameter 2"
"M-DS" Diameter Stem 2"
"M-BO" Balloon 2 1/2"

Wood Leg Options:



"W-SQ" Square 2 3/8"
"W-SQR" Square Radius 2 3/8"
"W-SQT" Square Tapered 2 3/8"
"W-DT" Diameter Tapered 2 3/8"
"W-SR" Safari 2 3/8"



"MC" Caster Option:
Available on all Metal Legs ONLY, with exception of the Balloon leg and Metal Bases.



*Shown Above:
TB-4242-DCH-M-D

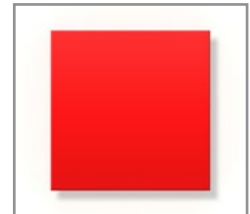

*Square Table Shape

MODEL NUMBER

PRODUCT

WIDTH DEPTH HEIGHT

PRICE

DESCRIPTION



*Shown Above:
TB-4242-AL-M-D

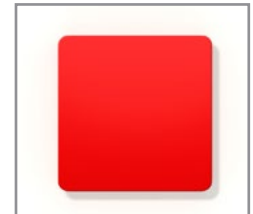

*Square Table Shape

MODEL NUMBER	PRODUCT	WIDTH	DEPTH	HEIGHT	PRICE
	Square Table, 42" Width, ALUMINUM Edge;	42"	42"	29"	
	with WOOD Leg Option:	42"	42"	29"	
TB-4242-AL-W-SQ	Square				\$ 1,225
TB-4242-AL-W-SQR	Square Radius				\$ 1,225
TB-4242-AL-W-SQT	Square Tapered				\$ 1,413
TB-4242-AL-W-DT	Diameter Tapered				\$ 1,575
TB-4242-AL-W-SR	Safari				\$ 1,588
	with METAL Leg Option:	42"	42"	29"	
TB-4242-AL-M-SQ	Square				\$ 1,144
TB-4242-AL-M-SS	Square & Stem				\$ 1,675
TB-4242-AL-M-D	Diameter				\$ 1,144
TB-4242-AL-M-DS	Diameter & Stem				\$ 1,675
TB-4242-AL-M-BO	Balloon				\$ 1,269
TB-4242-AL-MC-SQ	Square with Casters				\$ 1,425
TB-4242-AL-MC-SS	Square & Stem with Casters				\$ 1,956
TB-4242-AL-MC-D	Diameter with Casters				\$ 1,425
TB-4242-AL-MC-DS	Diameter & Stem with Casters				\$ 1,956
TB-4242-AL-FP1	Flat Pedestal 19" H	42"	42"	19"	\$ 1,831
TB-4242-AL-FP2	Flat Pedestal 29" H	42"	42"	29"	\$ 1,831
TB-4242-AL-FP3	Flat Pedestal 42" H	42"	42"	42"	\$ 1,925
TB-4242-AL-TP1	Trumpet 19" H	42"	42"	19"	\$ 1,488
TB-4242-AL-TP2	Trumpet 29" H	42"	42"	29"	\$ 1,488
TB-4242-AL-TP3	Trumpet 42" H	42"	42"	42"	\$ 1,706

Each Table Top is constructed using a 1 1/8" thick top with a Plastic Laminate top surface.

All Metal legs are coated electrostatically with an epoxy powder coat paint.

NOTES:

- * Table heights of 25" (children), 27" (youth), and 32" (wheelchair) are available by request.
- * Color of Metal Paint must be specified at the time of order.
- * Caster Leg options are recommended for Reading/Multipurpose Tables options and not meant to be used for stationary computer workstations.
- * For all tables with casters legs, only 2 legs will have casters, and the other legs will have levelers. This will create a "wheelbarrow" style of table which will ensure ease of mobility.
- * Color of the Caster Option must be specified at the time of order.

Edge Option:



"AL"
3mm Aluminum Edge *All table corners will be given a 6-inch radius for this edge option.

Metal Leg Options:



"M-SQ" Square 2"
"M-SS" Square Stem 2"
"M-D" Diameter 2"
"M-DS" Diameter Stem 2"
"M-BO" Balloon 2 1/2"
"FP" Flat Pedestal Base
"TP" Trumpet Base

Wood Leg Options:



"W-SQ" Square 2 3/8"
"W-SQR" Square Radius 2 3/8"
"W-SQT" Square Tapered 2 3/8"
"W-DT" Diameter Tapered 2 3/8"
"W-SR" Safari 2 3/8"



"MC" Caster Option:
Available on all Metal Legs ONLY, with exception of the Balloon leg and Metal Bases.

MODEL NUMBER

PRODUCT

WIDTH DEPTH HEIGHT

PRICE

DESCRIPTION



*Shown Above:
TB-4848-AC-M-D

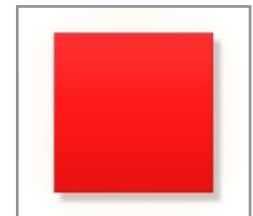

*Square Table Shape

- TB-4848-AC-W-SQ
- TB-4848-AC-W-SQR
- TB-4848-AC-W-SQT
- TB-4848-AC-W-DT
- TB-4848-AC-W-SR

Square Table, 48" Width,
ACRYLIC Edge;
with WOOD Leg Option:
Square
Square Radius
Square Tapered
Diameter Tapered
Safari

48" 48" 29"

- \$ 1,194
- \$ 1,194
- \$ 1,388
- \$ 1,544
- \$ 1,550

- TB-4848-AC-M-SQ
- TB-4848-AC-M-SS
- TB-4848-AC-M-D
- TB-4848-AC-M-DS
- TB-4848-AC-M-BO
- TB-4848-AC-MC-SQ
- TB-4848-AC-MC-SS
- TB-4848-AC-MC-D
- TB-4848-AC-MC-DS

with METAL Leg Option:
Square
Square & Stem
Diameter
Diameter & Stem
Balloon
Square with Casters
Square & Stem with Casters
Diameter with Casters
Diameter & Stem with Casters

48" 48" 29"

- \$ 1,113
- \$ 1,644
- \$ 1,113
- \$ 1,644
- \$ 1,244
- \$ 1,394
- \$ 1,925
- \$ 1,394
- \$ 1,925

- TB-4848-AC-FP1
- TB-4848-AC-FP2
- TB-4848-AC-FP3
- TB-4848-AC-TP1
- TB-4848-AC-TP2
- TB-4848-AC-TP3

Flat Pedestal 19" H
Flat Pedestal 29" H
Flat Pedestal 42" H
Trumpet 19" H
Trumpet 29" H
Trumpet 42" H

48" 48" 19"
48" 48" 29"
48" 48" 42"
48" 48" 19"
48" 48" 29"
48" 48" 42"

- \$ 2,206
- \$ 2,206
- \$ 2,300
- \$ 1,456
- \$ 1,456
- \$ 1,681

Each Table Top is constructed using a 1" thick top with a Plastic Laminate top surface.

All Metal legs are coated electrostatically with an epoxy powder coat paint.

NOTES:

- * Table heights of 25" (children), 27" (youth), and 32" (wheelchair) are available by request.
- * Color of Metal Paint must be specified at the time of order.
- * Caster Leg options are recommended for Reading/Multipurpose Tables options and not meant to be used for stationary computer workstations.
- * For all tables with casters legs, only 2 legs will have casters, and the other legs will have levelers. This will create a "wheelbarrow" style of table which will ensure ease of mobility.
- * Color of the Caster Option must be specified at the time of order.

Edge Option:

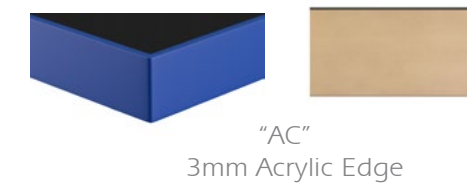

"AC"
3mm Acrylic Edge

Metal Leg Options:



"M-SQ" Square 2"
"M-SS" Square Stem 2"
"M-D" Diameter 2"
"M-DS" Diameter Stem 2"
"M-BO" Balloon 2 1/2"
"FP" Flat Pedestal Base
"TP" Trumpet Base

Wood Leg Options:

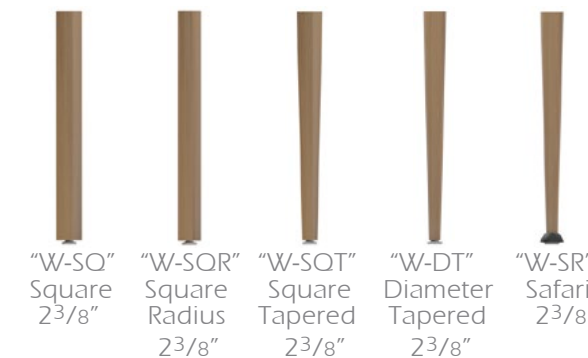

"W-SQ" Square 2 3/8"
"W-SQR" Square Radius 2 3/8"
"W-SQT" Square Tapered 2 3/8"
"W-DT" Diameter Tapered 2 3/8"
"W-SR" Safari 2 3/8"



"MC" Caster Option:
Available on all Metal Legs ONLY, with exception of the Balloon leg and Metal Bases.

MODEL NUMBER

PRODUCT

WIDTH DEPTH HEIGHT

PRICE

DESCRIPTION



*Shown Above:
TB-4848-SQ-M-D



*Square Table Shape

- TB-4848-SQ-W-SQ
- TB-4848-SQ-W-SQR
- TB-4848-SQ-W-SQT
- TB-4848-SQ-W-DT
- TB-4848-SQ-W-SR

Square Table, 48" Width,
SQUARE Edge;
with WOOD Leg Option:
Square
Square Radius
Square Tapered
Diameter Tapered
Safari

48" 48" 29"

- \$ 1,388
- \$ 1,388
- \$ 1,575
- \$ 1,738
- \$ 1,744

- TB-4848-SQ-M-SQ
- TB-4848-SQ-M-SS
- TB-4848-SQ-M-D
- TB-4848-SQ-M-DS
- TB-4848-SQ-M-BO
- TB-4848-SQ-MC-SQ
- TB-4848-SQ-MC-SS
- TB-4848-SQ-MC-D
- TB-4848-SQ-MC-DS

with METAL Leg Option:
Square
Square & Stem
Diameter
Diameter & Stem
Balloon
Square with Casters
Square & Stem with Casters
Diameter with Casters
Diameter & Stem with Casters

48" 48" 29"

- \$ 1,306
- \$ 1,831
- \$ 1,306
- \$ 1,831
- \$ 1,431
- \$ 1,588
- \$ 2,119
- \$ 1,588
- \$ 2,119

Each Table Top is constructed using a 1 1/8" thick top with a Plastic Laminate top surface.

All Metal legs are coated electrostatically with an epoxy powder coat paint.

NOTES:

- * Table heights of 25" (children), 27" (youth), and 32" (wheelchair) are available by request.
- * Color of Metal Paint must be specified at the time of order.
- * Caster Leg options are recommended for Reading/Multipurpose Tables options and not meant to be used for stationary computer workstations.
- * For all tables with casters legs, only 2 legs will have casters, and the other legs will have levelers. This will create a "wheelbarrow" style of table which will ensure ease of mobility.
- * Color of the Caster Option must be specified at the time of order.

Edge Option:



"SQ"
1/4" Square Edge

Metal Leg Options:



"M-SQ" Square 2"
"M-SS" Square Stem 2"
"M-D" Diameter 2"
"M-DS" Diameter Stem 2"
"M-BO" Balloon 2 1/2"

Wood Leg Options:



"W-SQ" Square 2 3/8"
"W-SQR" Square Radius 2 3/8"
"W-SQT" Square Tapered 2 3/8"
"W-DT" Diameter Tapered 2 3/8"
"W-SR" Safari 2 3/8"



Black/Black White/Grey Silver/Orange Mirror Finish/Grey

"MC" Caster Option:
Available on all Metal Legs ONLY, with exception of the Balloon leg and Metal Bases.

MODEL NUMBER	PRODUCT	WIDTH	DEPTH	HEIGHT
--------------	---------	-------	-------	--------

	Square Table, 48" Width,	48"	48"	29"
--	--------------------------	-----	-----	-----

	DROPPED SQUARE Edge;			
--	----------------------	--	--	--

	with WOOD Leg Option:	48"	48"	29"
--	-----------------------	-----	-----	-----

TB-4848-DSQ-W-SQ	Square
TB-4848-DSQ-W-SQR	Square Radius
TB-4848-DSQ-W-SQT	Square Tapered
TB-4848-DSQ-W-DT	Diameter Tapered
TB-4848-DSQ-W-SR	Safari

	with METAL Leg Option:	48"	48"	29"
--	------------------------	-----	-----	-----

TB-4848-DSQ-M-SQ	Square
TB-4848-DSQ-M-SS	Square & Stem
TB-4848-DSQ-M-D	Diameter
TB-4848-DSQ-M-DS	Diameter & Stem
TB-4848-DSQ-M-BO	Balloon
TB-4848-DSQ-MC-SQ	Square with Casters
TB-4848-DSQ-MC-SS	Square & Stem with Casters
TB-4848-DSQ-MC-D	Diameter with Casters
TB-4848-DSQ-MC-DS	Diameter & Stem with Casters



*Shown Above:
TB-4848-DSQ-M-D



*Square Table Shape

PRICE	DESCRIPTION
-------	-------------

\$ 1,488	Each Table Top is constructed using a 1 1/8" thick top with a Plastic Laminate top surface.
----------	---

\$ 1,488	All Metal legs are coated electrostatically with an epoxy powder coat paint.
----------	--

\$ 1,681	NOTES:
\$ 1,838	* Table heights of 25" (children), 27" (youth), and 32" (wheelchair) are available by request.
\$ 1,844	* Color of Metal Paint must be specified at the time of order.
	* Caster Leg options are recommended for Reading/Multipurpose Tables options and not meant to be used for stationary computer workstations.
	* For all tables with casters legs, only 2 legs will have casters, and the other legs will have levelers. This will create a "wheelbarrow" style of table which will ensure ease of mobility.
	* Color of the Caster Option must be specified at the time of order.

\$ 1,406
\$ 1,931
\$ 1,406
\$ 1,931
\$ 1,531
\$ 1,688
\$ 2,219
\$ 1,688
\$ 2,219

Edge Option:



Metal Leg Options:

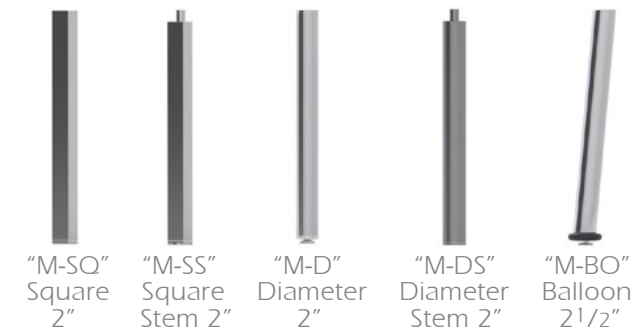

Wood Leg Options:

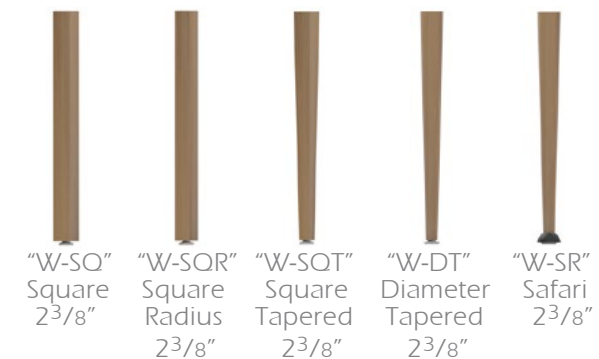

"MC" Caster Option:
Available on all Metal Legs ONLY, with exception of the Balloon leg and Metal Bases.

MODEL NUMBER	PRODUCT	WIDTH	DEPTH	HEIGHT
--------------	---------	-------	-------	--------



*Shown Above:
TB-4848-DBN-M-D



*Square Table Shape

	Square Table, 48" Width, DROPPED BULLNOSE Edge;	48"	48"	29"
	with WOOD Leg Option:	48"	48"	29"
TB-4848-DBN-W-SQ	Square			
TB-4848-DBN-W-SQR	Square Radius			
TB-4848-DBN-W-SQT	Square Tapered			
TB-4848-DBN-W-DT	Diameter Tapered			
TB-4848-DBN-W-SR	Safari			
	with METAL Leg Option:	48"	48"	29"
TB-4848-DBN-M-SQ	Square			
TB-4848-DBN-M-SS	Square & Stem			
TB-4848-DBN-M-D	Diameter			
TB-4848-DBN-M-DS	Diameter & Stem			
TB-4848-DBN-M-BO	Balloon			
TB-4848-DBN-MC-SQ	Square with Casters			
TB-4848-DBN-MC-SS	Square & Stem with Casters			
TB-4848-DBN-MC-D	Diameter with Casters			
TB-4848-DBN-MC-DS	Diameter & Stem with Casters			

PRICE	DESCRIPTION
-------	-------------

	Each Table Top is constructed using a 1 1/8" thick top with a Plastic Laminate top surface.
	All Metal legs are coated electrostatically with an epoxy powder coat paint.
	NOTES:
\$ 1,500	* Table heights of 25" (children), 27" (youth), and 32" (wheelchair) are available by request.
\$ 1,500	* Color of Metal Paint must be specified at the time of order.
\$ 1,688	* Caster Leg options are recommended for Reading/Multipurpose Tables options and not meant to be used for stationary computer workstations.
\$ 1,850	* For all tables with casters legs, only 2 legs will have casters, and the other legs will have levelers. This will create a "wheelbarrow" style of table which will ensure ease of mobility.
\$ 1,856	* Color of the Caster Option must be specified at the time of order.
\$ 1,419	
\$ 1,944	
\$ 1,419	
\$ 1,944	
\$ 1,544	
\$ 1,700	
\$ 2,231	
\$ 1,700	
\$ 2,231	

Edge Option:



"DBN"

3/4" Dropped Bullnoses Edge

Metal Leg Options:



"M-SQ"
Square
2"

"M-SS"
Square
Stem 2"

"M-D"
Diameter
2"

"M-DS"
Diameter
Stem 2"

"M-BO"
Balloon
2 1/2"

Wood Leg Options:



"W-SQ"
Square
2 3/8"

"W-SQR"
Square
Radius
2 3/8"

"W-SQT"
Square
Tapered
2 3/8"

"W-DT"
Diameter
Tapered
2 3/8"

"W-SR"
Safari
2 3/8"



Black/
Black

White/
Grey

Silver/
Orange

Mirror Finish/
Grey

"MC" Caster Option:

Available on all Metal Legs ONLY, with exception of the Balloon leg and Metal Bases.

MODEL NUMBER

PRODUCT

WIDTH DEPTH HEIGHT

PRICE

DESCRIPTION



*Shown Above:
TB-4848-DCH-M-D



*Square Table Shape

- TB-4848-DCH-W-SQ
- TB-4848-DCH-W-SQR
- TB-4848-DCH-W-SQT
- TB-4848-DCH-W-DT
- TB-4848-DCH-W-SR

Square Table, 48" Width,
DROPPED CHAMFERED Edge;
with WOOD Leg Option: 48" 48" 29"

- Square
- Square Radius
- Square Tapered
- Diameter Tapered
- Safari

- \$ 1,500
- \$ 1,500
- \$ 1,688
- \$ 1,850
- \$ 1,856

- TB-4848-DCH-M-SQ
- TB-4848-DCH-M-SS
- TB-4848-DCH-M-D
- TB-4848-DCH-M-DS
- TB-4848-DCH-M-BO
- TB-4848-DCH-MC-SQ
- TB-4848-DCH-MC-SS
- TB-4848-DCH-MC-D
- TB-4848-DCH-MC-DS

with METAL Leg Option: 48" 48" 29"

- Square
- Square & Stem
- Diameter
- Diameter & Stem
- Balloon
- Square with Casters
- Square & Stem with Casters
- Diameter with Casters
- Diameter & Stem with Casters

- \$ 1,419
- \$ 1,944
- \$ 1,419
- \$ 1,944
- \$ 1,544
- \$ 1,700
- \$ 2,231
- \$ 1,700
- \$ 2,231

Each Table Top is constructed using a 1 1/8" thick top with a Plastic Laminate top surface.

All Metal legs are coated electrostatically with an epoxy powder coat paint.

NOTES:

- * Table heights of 25" (children), 27" (youth), and 32" (wheelchair) are available by request.
- * Color of Metal Paint must be specified at the time of order.
- * Caster Leg options are recommended for Reading/Multipurpose Tables options and not meant to be used for stationary computer workstations.
- * For all tables with casters legs, only 2 legs will have casters, and the other legs will have levelers. This will create a "wheelbarrow" style of table which will ensure ease of mobility.
- * Color of the Caster Option must be specified at the time of order.

Edge Option:



"DCH"

5/8" Dropped Chamfered Edge

Metal Leg Options:

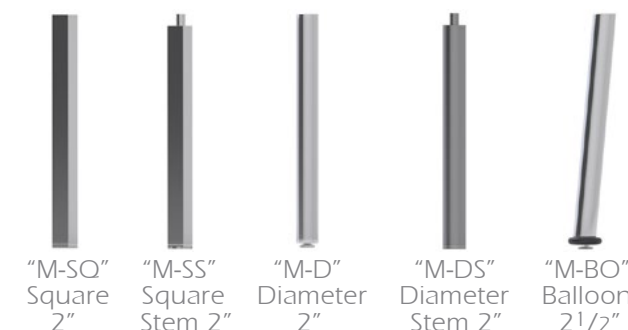

"M-SQ" Square 2"
"M-SS" Square Stem 2"
"M-D" Diameter 2"
"M-DS" Diameter Stem 2"
"M-BO" Balloon 2 1/2"

Wood Leg Options:

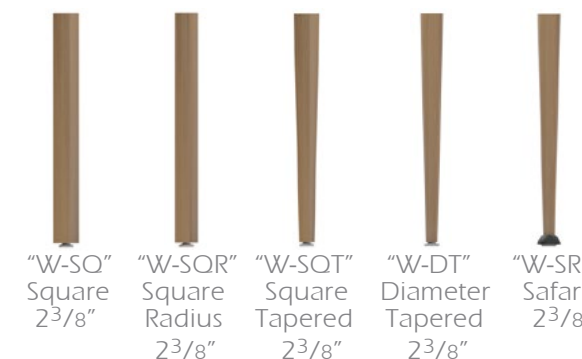

"W-SQ" Square 2 3/8"
"W-SQR" Square Radius 2 3/8"
"W-SQT" Square Tapered 2 3/8"
"W-DT" Diameter Tapered 2 3/8"
"W-SR" Safari 2 3/8"



"MC" Caster Option:
Available on all Metal Legs ONLY, with exception of the Balloon leg and Metal Bases.

MODEL NUMBER

PRODUCT

WIDTH DEPTH HEIGHT

PRICE

DESCRIPTION



*Shown Above:
TB-4848-AL-M-D



*Square Table Shape

MODEL NUMBER	PRODUCT	WIDTH	DEPTH	HEIGHT	PRICE
	Square Table, 48" Width, ALUMINUM Edge;	48"	48"	29"	
	with WOOD Leg Option:	48"	48"	29"	
TB-4848-AL-W-SQ	Square				\$ 1,306
TB-4848-AL-W-SQR	Square Radius				\$ 1,306
TB-4848-AL-W-SQT	Square Tapered				\$ 1,500
TB-4848-AL-W-DT	Diameter Tapered				\$ 1,663
TB-4848-AL-W-SR	Safari				\$ 1,669
	with METAL Leg Option:	48"	48"	29"	
TB-4848-AL-M-SQ	Square				\$ 1,231
TB-4848-AL-M-SS	Square & Stem				\$ 1,756
TB-4848-AL-M-D	Diameter				\$ 1,231
TB-4848-AL-M-DS	Diameter & Stem				\$ 1,756
TB-4848-AL-M-BO	Balloon				\$ 1,356
TB-4848-AL-MC-SQ	Square with Casters				\$ 1,506
TB-4848-AL-MC-SS	Square & Stem with Casters				\$ 2,044
TB-4848-AL-MC-D	Diameter with Casters				\$ 1,506
TB-4848-AL-MC-DS	Diameter & Stem with Casters				\$ 2,044
TB-4848-AL-FP1	Flat Pedestal 19" H	48"	48"	19"	\$ 2,319
TB-4848-AL-FP2	Flat Pedestal 29" H	48"	48"	29"	\$ 2,319
TB-4848-AL-FP3	Flat Pedestal 42" H	48"	48"	42"	\$ 2,419
TB-4848-AL-TP1	Trumpet 19" H	48"	48"	19"	\$ 1,569
TB-4848-AL-TP2	Trumpet 29" H	48"	48"	29"	\$ 1,569
TB-4848-AL-TP3	Trumpet 42" H	48"	48"	42"	\$ 1,794

Each Table Top is constructed using a 1 1/8" thick top with a Plastic Laminate top surface.

All Metal legs are coated electrostatically with an epoxy powder coat paint.

NOTES:

* Table heights of 25" (children), 27" (youth), and 32" (wheelchair) are available by request.

* Color of Metal Paint must be specified at the time of order.

* Caster Leg options are recommended for Reading/Multipurpose Tables options and not meant to be used for stationary computer workstations.

* For all tables with casters legs, only 2 legs will have casters, and the other legs will have levelers. This will create a "wheelbarrow" style of table which will ensure ease of mobility.

* Color of the Caster Option must be specified at the time of order.

Edge Option:

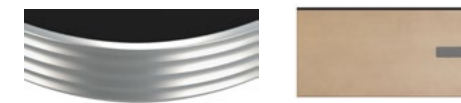

"AL"
3mm Aluminum Edge *All table corners will be given a 6-inch radius for this edge option.

Metal Leg Options:



"M-SQ" Square 2"
"M-SS" Square Stem 2"
"M-D" Diameter 2"
"M-DS" Diameter Stem 2"
"M-BO" Balloon 2 1/2"
"FP" Flat Pedestal Base
"TP" Trumpet Base

Wood Leg Options:



"W-SQ" Square 2 3/8"
"W-SQR" Square Radius 2 3/8"
"W-SQT" Square Tapered 2 3/8"
"W-DT" Diameter Tapered 2 3/8"
"W-SR" Safari 2 3/8"



Black/Black White/Grey Silver/Orange Mirror Finish/Grey
"MC" Caster Option:
Available on all Metal Legs ONLY, with exception of the Balloon leg and Metal Bases.

MODEL NUMBER

PRODUCT

WIDTH DEPTH HEIGHT

PRICE

DESCRIPTION



*Shown Above:
TB-3624-AC-M-D



*Rectangle Table Shape

- TB-3624-AC-W-SQ
- TB-3624-AC-W-SQR
- TB-3624-AC-W-SQT
- TB-3624-AC-W-DT
- TB-3624-AC-W-SR

Rectangle Table, 36" Width,
ACRYLIC Edge;
with WOOD Leg Option:
Square
Square Radius
Square Tapered
Diameter Tapered
Safari

36" 24" 29"

- \$ 1,013
- \$ 1,013
- \$ 1,206
- \$ 1,369
- \$ 1,375

- TB-3624-AC-M-SQ
- TB-3624-AC-M-SS
- TB-3624-AC-M-D
- TB-3624-AC-M-DS
- TB-3624-AC-M-BO
- TB-3624-AC-MC-SQ
- TB-3624-AC-MC-SS
- TB-3624-AC-MC-D
- TB-3624-AC-MC-DS

with METAL Leg Option:
Square
Square & Stem
Diameter
Diameter & Stem
Balloon
Square with Casters
Square & Stem with Casters
Diameter with Casters
Diameter & Stem with Casters

36" 24" 29"

- \$ 931
- \$ 1,463
- \$ 931
- \$ 1,463
- \$ 1,063
- \$ 1,213
- \$ 1,744
- \$ 1,213
- \$ 1,744

Each Table Top is constructed using a 1" thick top with a Plastic Laminate top surface.

All Metal legs are coated electrostatically with an epoxy powder coat paint.

NOTES:

- * Table heights of 25" (children), 27" (youth), and 32" (wheelchair) are available by request.
- * Color of Metal Paint must be specified at the time of order.
- * Caster Leg options are recommended for Reading/Multipurpose Tables options and not meant to be used for stationary computer workstations.
- * For all tables with casters legs, only 2 legs will have casters, and the other legs will have levelers. This will create a "wheelbarrow" style of table which will ensure ease of mobility.
- * Color of the Caster Option must be specified at the time of order.

Edge Option:

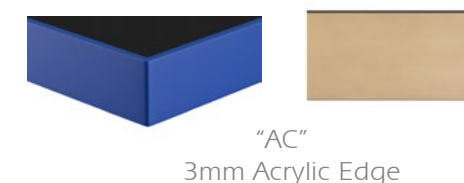

"AC"
3mm Acrylic Edge

Metal Leg Options:

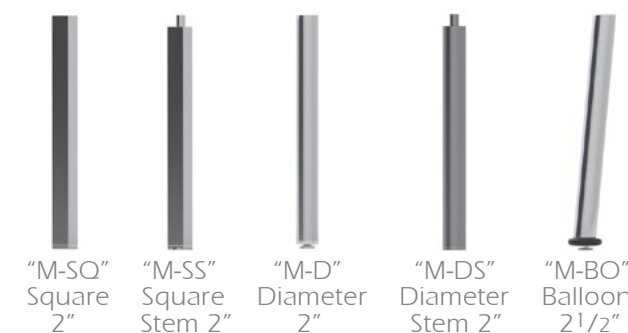

"M-SQ" Square 2"
"M-SS" Square Stem 2"
"M-D" Diameter 2"
"M-DS" Diameter Stem 2"
"M-BO" Balloon 2 1/2"

Wood Leg Options:

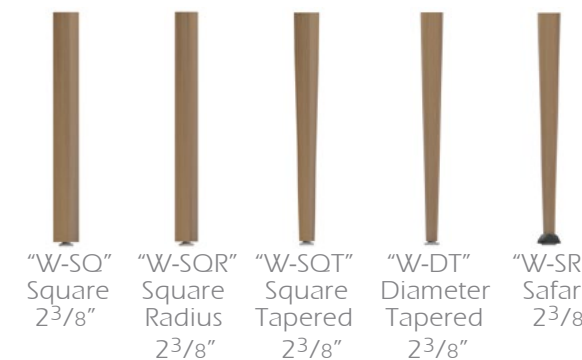

"W-SQ" Square 2 3/8"
"W-SQR" Square Radius 2 3/8"
"W-SQT" Square Tapered 2 3/8"
"W-DT" Diameter Tapered 2 3/8"
"W-SR" Safari 2 3/8"



"MC" Caster Option:
Available on all Metal Legs ONLY, with exception of the Balloon leg and Metal Bases.

MODEL NUMBER
PRODUCT
WIDTH DEPTH HEIGHT
PRICE
DESCRIPTION

*Shown Above:
TB-3624-SQ-M-D



*Rectangle Table Shape

TB-3624-SQ-W-SQ
TB-3624-SQ-W-SQR
TB-3624-SQ-W-SQT
TB-3624-SQ-W-DT
TB-3624-SQ-W-SR

Rectangle Table, 36" Width,
SQUARE Edge;
with WOOD Leg Option:
Square
Square Radius
Square Tapered
Diameter Tapered
Safari

36" 24" 29"

\$ 1,131
\$ 1,131
\$ 1,325
\$ 1,488
\$ 1,494

TB-3624-SQ-M-SQ
TB-3624-SQ-M-SS
TB-3624-SQ-M-D
TB-3624-SQ-M-DS
TB-3624-SQ-M-BO
TB-3624-SQ-MC-SQ
TB-3624-SQ-MC-SS
TB-3624-SQ-MC-D
TB-3624-SQ-MC-DS

with METAL Leg Option:
Square
Square & Stem
Diameter
Diameter & Stem
Balloon
Square with Casters
Square & Stem with Casters
Diameter with Casters
Diameter & Stem with Casters

36" 24" 29"

\$ 1,050
\$ 1,581
\$ 1,050
\$ 1,581
\$ 1,181
\$ 1,331
\$ 1,863
\$ 1,331
\$ 1,863

Each Table Top is constructed using a 1 1/8" thick top with a Plastic Laminate top surface.

All Metal legs are coated electrostatically with an epoxy powder coat paint.

NOTES:

- * Table heights of 25" (children), 27" (youth), and 32" (wheelchair) are available by request.
- * Color of Metal Paint must be specified at the time of order.
- * Caster Leg options are recommended for Reading/Multipurpose Tables options and not meant to be used for stationary computer workstations.
- * For all tables with casters legs, only 2 legs will have casters, and the other legs will have levelers. This will create a "wheelbarrow" style of table which will ensure ease of mobility.
- * Color of the Caster Option must be specified at the time of order.

Edge Option:

"SQ"
1/4" Square Edge

Metal Leg Options:

"M-SQ" Square 2"
"M-SS" Square Stem 2"
"M-D" Diameter 2"
"M-DS" Diameter Stem 2"
"M-BO" Balloon 2 1/2"

Wood Leg Options:

"W-SQ" Square 2 3/8"
"W-SQR" Square Radius 2 3/8"
"W-SQT" Square Tapered 2 3/8"
"W-DT" Diameter Tapered 2 3/8"
"W-SR" Safari 2 3/8"



Black/Black
White/Grey
Silver/Orange
Mirror Finish/Grey

"MC" Caster Option:
Available on all Metal Legs ONLY, with exception of the Balloon leg and Metal Bases.

MODEL NUMBER	PRODUCT	WIDTH	DEPTH	HEIGHT
--------------	---------	-------	-------	--------



*Shown Above:
TB-3624-DSQ-M-D



*Rectangle Table Shape

	Rectangle Table, 36" Width, DROPPED SQUARE Edge;	36"	24"	29"
	with WOOD Leg Option:	36"	24"	29"
TB-3624-DSQ-W-SQ	Square			
TB-3624-DSQ-W-SQR	Square Radius			
TB-3624-DSQ-W-SQT	Square Tapered			
TB-3624-DSQ-W-DT	Diameter Tapered			
TB-3624-DSQ-W-SR	Safari			
	with METAL Leg Option:	36"	24"	29"
TB-3624-DSQ-M-SQ	Square			
TB-3624-DSQ-M-SS	Square & Stem			
TB-3624-DSQ-M-D	Diameter			
TB-3624-DSQ-M-DS	Diameter & Stem			
TB-3624-DSQ-M-BO	Balloon			
TB-3624-DSQ-MC-SQ	Square with Casters			
TB-3624-DSQ-MC-SS	Square & Stem with Casters			
TB-3624-DSQ-MC-D	Diameter with Casters			
TB-3624-DSQ-MC-DS	Diameter & Stem with Casters			

PRICE	DESCRIPTION
-------	-------------

	Each Table Top is constructed using a 1 1/8" thick top with a Plastic Laminate top surface.
	All Metal legs are coated electrostatically with an epoxy powder coat paint.
	NOTES:
\$ 1,169	* Table heights of 25" (children), 27" (youth), and 32" (wheelchair) are available by request.
\$ 1,169	* Color of Metal Paint must be specified at the time of order.
\$ 1,356	* Caster Leg options are recommended for Reading/Multipurpose Tables options and not meant to be used for stationary computer workstations.
\$ 1,519	* For all tables with casters legs, only 2 legs will have casters, and the other legs will have levelers. This will create a "wheelbarrow" style of table which will ensure ease of mobility.
\$ 1,525	* Color of the Caster Option must be specified at the time of order.

Edge Option:



"DSQ"
3/4" Dropped Square Edge

Metal Leg Options:



"M-SQ" Square 2"
"M-SS" Square Stem 2"
"M-D" Diameter 2"
"M-DS" Diameter Stem 2"
"M-BO" Balloon 2 1/2"

Wood Leg Options:



"W-SQ" Square 2 3/8"
"W-SQR" Square Radius 2 3/8"
"W-SQT" Square Tapered 2 3/8"
"W-DT" Diameter Tapered 2 3/8"
"W-SR" Safari 2 3/8"



"MC" Caster Option:
Available on all Metal Legs ONLY, with exception of the Balloon leg and Metal Bases.

MODEL NUMBER

PRODUCT

WIDTH DEPTH HEIGHT

PRICE

DESCRIPTION



*Shown Above:
TB-3624-DBN-M-D



*Rectangle Table Shape

- TB-3624-DBN-W-SQ
- TB-3624-DBN-W-SQR
- TB-3624-DBN-W-SQT
- TB-3624-DBN-W-DT
- TB-3624-DBN-W-SR

with WOOD Leg Option:

- Square
- Square Radius
- Square Tapered
- Diameter Tapered
- Safari

36" 24" 29"

- \$ 1,181
- \$ 1,181
- \$ 1,369
- \$ 1,531
- \$ 1,544

with METAL Leg Option:

- TB-3624-DBN-M-SQ Square
- TB-3624-DBN-M-SS Square & Stem
- TB-3624-DBN-M-D Diameter
- TB-3624-DBN-M-DS Diameter & Stem
- TB-3624-DBN-M-BO Balloon
- TB-3624-DBN-MC-SQ Square with Casters
- TB-3624-DBN-MC-SS Square & Stem with Casters
- TB-3624-DBN-MC-D Diameter with Casters
- TB-3624-DBN-MC-DS Diameter & Stem with Casters

36" 24" 29"

- \$ 1,100
- \$ 1,631
- \$ 1,100
- \$ 1,631
- \$ 1,231
- \$ 1,381
- \$ 1,913
- \$ 1,381
- \$ 1,913

Each Table Top is constructed using a 1 1/8" thick top with a Plastic Laminate top surface.

All Metal legs are coated electrostatically with an epoxy powder coat paint.

NOTES:

- * Table heights of 25" (children), 27" (youth), and 32" (wheelchair) are available by request.
- * Color of Metal Paint must be specified at the time of order.
- * Caster Leg options are recommended for Reading/Multipurpose Tables options and not meant to be used for stationary computer workstations.
- * For all tables with casters legs, only 2 legs will have casters, and the other legs will have levelers. This will create a "wheelbarrow" style of table which will ensure ease of mobility.
- * Color of the Caster Option must be specified at the time of order.

Edge Option:



"DBN"

3/4" Dropped Bullnoses Edge

Metal Leg Options:



- "M-SQ" Square 2"
- "M-SS" Square Stem 2"
- "M-D" Diameter 2"
- "M-DS" Diameter Stem 2"
- "M-BO" Balloon 2 1/2"

Wood Leg Options:



- "W-SQ" Square 2 3/8"
- "W-SQR" Square Radius 2 3/8"
- "W-SQT" Square Tapered 2 3/8"
- "W-DT" Diameter Tapered 2 3/8"
- "W-SR" Safari 2 3/8"



"MC" Caster Option:
Available on all Metal Legs ONLY, with exception of the Balloon leg and Metal Bases.

MODEL NUMBER	PRODUCT	WIDTH	DEPTH	HEIGHT
 <p>*Shown Above: TB-3624-DCH-M-D</p>	Rectangle Table, 36" Width, DROPPED CHAMFERED Edge;	36"	24"	29"
	with WOOD Leg Option:	36"	24"	29"
	TB-3624-DCH-W-SQ	Square		
	TB-3624-DCH-W-SQR	Square Radius		
	TB-3624-DCH-W-SQT	Square Tapered		
TB-3624-DCH-W-DT	Diameter Tapered			
TB-3624-DCH-W-SR	Safari			
 <p>*Rectangle Table Shape</p>	with METAL Leg Option:	36"	24"	29"
	TB-3624-DCH-M-SQ	Square		
	TB-3624-DCH-M-SS	Square & Stem		
	TB-3624-DCH-M-D	Diameter		
	TB-3624-DCH-M-DS	Diameter & Stem		
	TB-3624-DCH-M-BO	Balloon		
	TB-3624-DCH-MC-SQ	Square with Casters		
	TB-3624-DCH-MC-SS	Square & Stem with Casters		
	TB-3624-DCH-MC-D	Diameter with Casters		
	TB-3624-DCH-MC-DS	Diameter & Stem with Casters		

PRICE

\$ 1,181
\$ 1,181
\$ 1,369
\$ 1,531
\$ 1,544

\$ 1,100
\$ 1,631
\$ 1,100
\$ 1,631
\$ 1,231
\$ 1,381
\$ 1,913
\$ 1,381
\$ 1,913

DESCRIPTION

Each Table Top is constructed using a 1 1/8" thick top with a Plastic Laminate top surface.

All Metal legs are coated electrostatically with an epoxy powder coat paint.

NOTES:

- * Table heights of 25" (children), 27" (youth), and 32" (wheelchair) are available by request.
- * Color of Metal Paint must be specified at the time of order.
- * Caster Leg options are recommended for Reading/Multipurpose Tables options and not meant to be used for stationary computer workstations.
- * For all tables with casters legs, only 2 legs will have casters, and the other legs will have levelers. This will create a "wheelbarrow" style of table which will ensure ease of mobility.
- * Color of the Caster Option must be specified at the time of order.

Edge Option:



"DCH"

5/8" Dropped Chamfered Edge

Metal Leg Options:



"M-SQ" Square 2"
"M-SS" Square Stem 2"
"M-D" Diameter 2"
"M-DS" Diameter Stem 2"
"M-BO" Balloon 2 1/2"

Wood Leg Options:



"W-SQ" Square 2 3/8"
"W-SQR" Square Radius 2 3/8"
"W-SQT" Square Tapered 2 3/8"
"W-DT" Diameter Tapered 2 3/8"
"W-SR" Safari 2 3/8"



Black/Black
White/Grey
Silver/Orange
Mirror Finish/Grey

"MC" Caster Option:

Available on all Metal Legs ONLY, with exception of the Balloon leg and Metal Bases.

MODEL NUMBER	PRODUCT	WIDTH	DEPTH	HEIGHT	
 *Shown Above: TB-3624-AL-M-D	Rectangle Table, 36" Width,	36"	24"	29"	
	ALUMINUM Edge;				
	with WOOD Leg Option:	36"	24"	29"	
	TB-3624-AL-W-SQ TB-3624-AL-W-SQR TB-3624-AL-W-SQT TB-3624-AL-W-DT TB-3624-AL-W-SR	Square Square Radius Square Tapered Diameter Tapered Safari			
	with METAL Leg Option:	36"	24"	29"	
TB-3624-AL-M-SQ TB-3624-AL-M-SS TB-3624-AL-M-D TB-3624-AL-M-DS TB-3624-AL-M-BO TB-3624-AL-MC-SQ TB-3624-AL-MC-SS TB-3624-AL-MC-D TB-3624-AL-MC-DS	Square Square & Stem Diameter Diameter & Stem Balloon Square with Casters Square & Stem with Casters Diameter with Casters Diameter & Stem with Casters				



*Rectangle Table Shape

PRICE	DESCRIPTION
	Each Table Top is constructed using a 1 1/8" thick top with a Plastic Laminate top surface.
	All Metal legs are coated electrostatically with an epoxy powder coat paint.
	NOTES: * Table heights of 25" (children), 27" (youth), and 32" (wheelchair) are available by request. * Color of Metal Paint must be specified at the time of order. * Caster Leg options are recommended for Reading/Multipurpose Tables options and not meant to be used for stationary computer workstations. * For all tables with casters legs, only 2 legs will have casters, and the other legs will have levelers. This will create a "wheelbarrow" style of table which will ensure ease of mobility. * Color of the Caster Option must be specified at the time of order.
\$ 1,106	
\$ 1,106	
\$ 1,294	
\$ 1,456	
\$ 1,463	
\$ 1,025	
\$ 1,550	
\$ 1,025	
\$ 1,550	
\$ 1,150	
\$ 1,306	
\$ 1,838	
\$ 1,306	
\$ 1,838	

Edge Option:



3mm Aluminum Edge *All table corners will be given a 6-inch radius for this edge option.

Metal Leg Options:



"M-SQ" Square 2"
 "M-SS" Square Stem 2"
 "M-D" Diameter 2"
 "M-DS" Diameter Stem 2"
 "M-BO" Balloon 2 1/2"

Wood Leg Options:



"W-SQ" Square 2 3/8"
 "W-SQR" Square Radius 2 3/8"
 "W-SQT" Square Tapered 2 3/8"
 "W-DT" Diameter Tapered 2 3/8"
 "W-SR" Safari 2 3/8"



"MC" Caster Option:
 Available on all Metal Legs ONLY, with exception of the Balloon leg and Metal Bases.

MODEL NUMBER **PRODUCT** **WIDTH** **DEPTH** **HEIGHT**



*Shown Above:
TB-4824-AC-M-D



*Rectangle Table Shape

	Rectangle Table, 48" Width, 24" Depth	48"	24"	29"
	ACRYLIC Edge;			
	with WOOD Leg Option:	48"	24"	29"
TB-4824-AC-W-SQ	Square			
TB-4824-AC-W-SQR	Square Radius			
TB-4824-AC-W-SQT	Square Tapered			
TB-4824-AC-W-DT	Diameter Tapered			
TB-4824-AC-W-SR	Safari			
	with METAL Leg Option:	48"	24"	29"
TB-4824-AC-M-SQ	Square			
TB-4824-AC-M-SS	Square & Stem			
TB-4824-AC-M-D	Diameter			
TB-4824-AC-M-DS	Diameter & Stem			
TB-4824-AC-M-BO	Balloon			
TB-4824-AC-MC-SQ	Square with Casters			
TB-4824-AC-MC-SS	Square & Stem with Casters			
TB-4824-AC-MC-D	Diameter with Casters			
TB-4824-AC-MC-DS	Diameter & Stem with Casters			
	Rectangle Table, 48" Width, 30" Depth	48"	30"	29"
	ACRYLIC Edge;			
	with WOOD Leg Option:	48"	30"	29"
TB-4830-AC-W-SQ	Square			
TB-4830-AC-W-SQR	Square Radius			
TB-4830-AC-W-SQT	Square Tapered			
TB-4830-AC-W-DT	Diameter Tapered			
TB-4830-AC-W-SR	Safari			
	with METAL Leg Option:	48"	30"	29"
TB-4830-AC-M-SQ	Square			
TB-4830-AC-M-SS	Square & Stem			
TB-4830-AC-M-D	Diameter			
TB-4830-AC-M-DS	Diameter & Stem			
TB-4830-AC-M-BO	Balloon			
TB-4830-AC-MC-SQ	Square with Casters			
TB-4830-AC-MC-SS	Square & Stem with Casters			
TB-4830-AC-MC-D	Diameter with Casters			
TB-4830-AC-MC-DS	Diameter & Stem with Casters			

PRICE **DESCRIPTION**

Each Table Top is constructed using a 1" thick top with a Plastic Laminate top surface.

All Metal legs are coated electrostatically with an epoxy powder coat paint.

NOTES:

- * Table heights of 25" (children), 27" (youth), and 32" (wheelchair) are available by request.
- * Color of Metal Paint must be specified at the time of order.
- * Caster Leg options are recommended for Reading/Multipurpose Tables options and not meant to be used for stationary computer workstations.
- * For all tables with casters legs, only 2 legs will have casters, and the other legs will have levelers. This will create a "wheelbarrow" style of table which will ensure ease of mobility.
- * Color of the Caster Option must be specified at the time of order.

\$ 1,050
\$ 1,050
\$ 1,244
\$ 1,406
\$ 1,413

\$ 975
\$ 1,500
\$ 975
\$ 1,500
\$ 1,100
\$ 1,250
\$ 1,781
\$ 1,250
\$ 1,781

Edge Option:

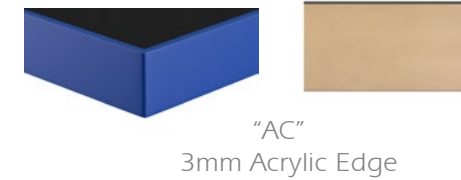

"AC"
3mm Acrylic Edge

Metal Leg Options:

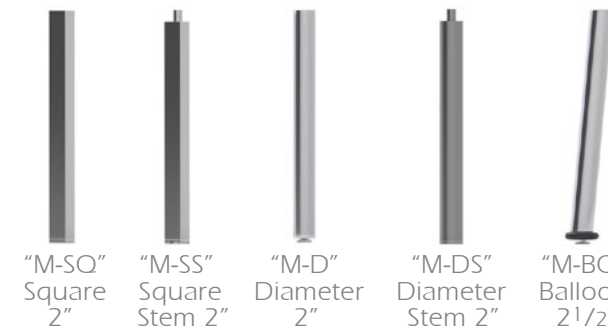

"M-SQ" Square 2"
"M-SS" Square Stem 2"
"M-D" Diameter 2"
"M-DS" Diameter Stem 2"
"M-BO" Balloon 2 1/2"

Wood Leg Options:

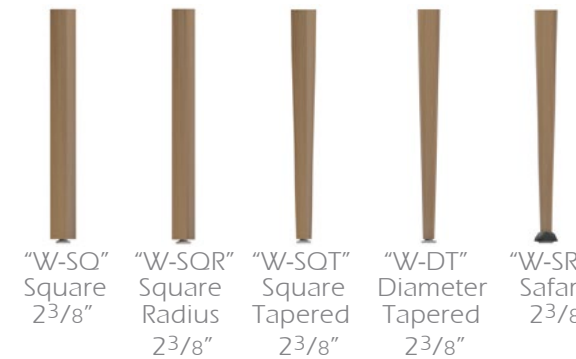

"W-SQ" Square 2 3/8"
"W-SQR" Square Radius 2 3/8"
"W-SQT" Square Tapered 2 3/8"
"W-DT" Diameter Tapered 2 3/8"
"W-SR" Safari 2 3/8"



"MC" Caster Option:
Available on all Metal Legs ONLY, with exception of the Balloon leg and Metal Bases.

MODEL NUMBER

PRODUCT

WIDTH DEPTH HEIGHT

PRICE

DESCRIPTION



*Shown Above:
TB-4824-SQ-M-D



*Rectangle Table Shape

MODEL NUMBER	PRODUCT	WIDTH	DEPTH	HEIGHT	PRICE
	Rectangle Table, 48" Width, 24" Depth	48"	24"	29"	
	SQUARE Edge;				
	with WOOD Leg Option:	48"	24"	29"	
TB-4824-SQ-W-SQ	Square				\$ 1,194
TB-4824-SQ-W-SQR	Square Radius				\$ 1,194
TB-4824-SQ-W-SQT	Square Tapered				\$ 1,388
TB-4824-SQ-W-DT	Diameter Tapered				\$ 1,544
TB-4824-SQ-W-SR	Safari				\$ 1,550
	with METAL Leg Option:	48"	24"	29"	
TB-4824-SQ-M-SQ	Square				\$ 1,113
TB-4824-SQ-M-SS	Square & Stem				\$ 1,644
TB-4824-SQ-M-D	Diameter				\$ 1,113
TB-4824-SQ-M-DS	Diameter & Stem				\$ 1,644
TB-4824-SQ-M-BO	Balloon				\$ 1,244
TB-4824-SQ-MC-SQ	Square with Casters				\$ 1,394
TB-4824-SQ-MC-SS	Square & Stem with Casters				\$ 1,925
TB-4824-SQ-MC-D	Diameter with Casters				\$ 1,394
TB-4824-SQ-MC-DS	Diameter & Stem with Casters				\$ 1,925
	Rectangle Table, 48" Width, 30" Depth	48"	30"	29"	
	SQUARE Edge;				
	with WOOD Leg Option:	48"	30"	29"	
TB-4830-SQ-W-SQ	Square				\$ 1,244
TB-4830-SQ-W-SQR	Square Radius				\$ 1,244
TB-4830-SQ-W-SQT	Square Tapered				\$ 1,431
TB-4830-SQ-W-DT	Diameter Tapered				\$ 1,594
TB-4830-SQ-W-SR	Safari				\$ 1,600
	with METAL Leg Option:	48"	30"	29"	
TB-4830-SQ-M-SQ	Square				\$ 1,163
TB-4830-SQ-M-SS	Square & Stem				\$ 1,688
TB-4830-SQ-M-D	Diameter				\$ 1,163
TB-4830-SQ-M-DS	Diameter & Stem				\$ 1,688
TB-4830-SQ-M-BO	Balloon				\$ 1,288
TB-4830-SQ-MC-SQ	Square with Casters				\$ 1,444
TB-4830-SQ-MC-SS	Square & Stem with Casters				\$ 1,975
TB-4830-SQ-MC-D	Diameter with Casters				\$ 1,444
TB-4830-SQ-MC-DS	Diameter & Stem with Casters				\$ 1,975

Each Table Top is constructed using a 1 1/8" thick top with a Plastic Laminate top surface.

All Metal legs are coated electrostatically with an epoxy powder coat paint.

NOTES:

- * Table heights of 25" (children), 27" (youth), and 32" (wheelchair) are available by request.
- * Color of Metal Paint must be specified at the time of order.
- * Caster Leg options are recommended for Reading/Multipurpose Tables options and not meant to be used for stationary computer workstations.
- * For all tables with casters legs, only 2 legs will have casters, and the other legs will have levelers. This will create a "wheelbarrow" style of table which will ensure ease of mobility.
- * Color of the Caster Option must be specified at the time of order.

Edge Option:



"SQ"
1/4" Square Edge

Metal Leg Options:

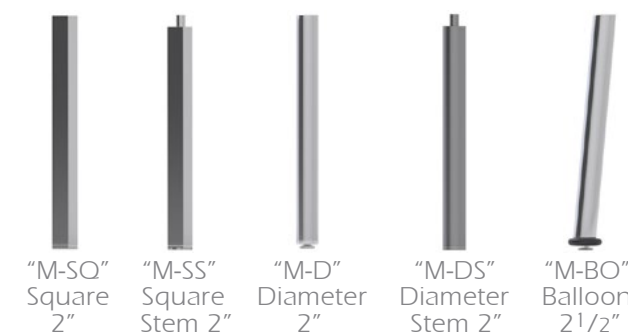

"M-SQ" Square 2"
"M-SS" Square Stem 2"
"M-D" Diameter 2"
"M-DS" Diameter Stem 2"
"M-BO" Balloon 2 1/2"

Wood Leg Options:

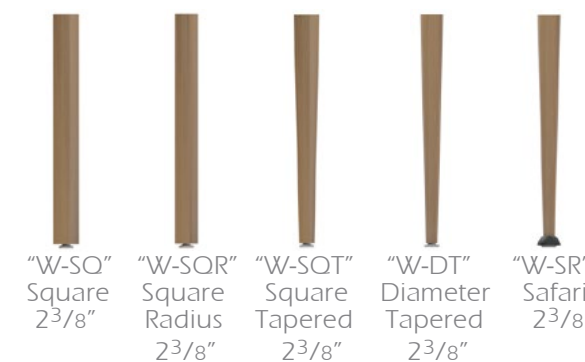

"W-SQ" Square 2 3/8"
"W-SQR" Square Radius 2 3/8"
"W-SQT" Square Tapered 2 3/8"
"W-DT" Diameter Tapered 2 3/8"
"W-SR" Safari 2 3/8"



"MC" Caster Option:
Available on all Metal Legs ONLY, with exception of the Balloon leg and Metal Bases.

MODEL NUMBER

PRODUCT

WIDTH DEPTH HEIGHT

PRICE

DESCRIPTION



*Shown Above:
TB-4824-DSQ-M-D



*Rectangle Table Shape

MODEL NUMBER	PRODUCT	WIDTH	DEPTH	HEIGHT	PRICE
	Rectangle Table, 48" Width, 24" Depth	48"	24"	29"	
	DROPPED SQUARE Edge;				
	with WOOD Leg Option:	48"	24"	29"	
TB-4824-DSQ-W-SQ	Square				\$ 1,269
TB-4824-DSQ-W-SQR	Square Radius				\$ 1,269
TB-4824-DSQ-W-SQT	Square Tapered				\$ 1,456
TB-4824-DSQ-W-DT	Diameter Tapered				\$ 1,619
TB-4824-DSQ-W-SR	Safari				\$ 1,625
	with METAL Leg Option:	48"	24"	29"	
TB-4824-DSQ-M-SQ	Square				\$ 1,188
TB-4824-DSQ-M-SS	Square & Stem				\$ 1,713
TB-4824-DSQ-M-D	Diameter				\$ 1,188
TB-4824-DSQ-M-DS	Diameter & Stem				\$ 1,713
TB-4824-DSQ-M-BO	Balloon				\$ 1,313
TB-4824-DSQ-MC-SQ	Square with Casters				\$ 1,469
TB-4824-DSQ-MC-SS	Square & Stem with Casters				\$ 2,000
TB-4824-DSQ-MC-D	Diameter with Casters				\$ 1,469
TB-4824-DSQ-MC-DS	Diameter & Stem with Casters				\$ 2,000
	Rectangle Table, 48" Width, 30" Depth	48"	30"	29"	
	DROPPED SQUARE Edge;				
	with WOOD Leg Option:	48"	30"	29"	
TB-4830-DSQ-W-SQ	Square				\$ 1,319
TB-4830-DSQ-W-SQR	Square Radius				\$ 1,319
TB-4830-DSQ-W-SQT	Square Tapered				\$ 1,506
TB-4830-DSQ-W-DT	Diameter Tapered				\$ 1,669
TB-4830-DSQ-W-SR	Safari				\$ 1,681
	with METAL Leg Option:	48"	30"	29"	
TB-4830-DSQ-M-SQ	Square				\$ 1,238
TB-4830-DSQ-M-SS	Square & Stem				\$ 1,769
TB-4830-DSQ-M-D	Diameter				\$ 1,238
TB-4830-DSQ-M-DS	Diameter & Stem				\$ 1,769
TB-4830-DSQ-M-BO	Balloon				\$ 1,369
TB-4830-DSQ-MC-SQ	Square with Casters				\$ 1,525
TB-4830-DSQ-MC-SS	Square & Stem with Casters				\$ 2,050
TB-4830-DSQ-MC-D	Diameter with Casters				\$ 1,525
TB-4830-DSQ-MC-DS	Diameter & Stem with Casters				\$ 2,050

Each Table Top is constructed using a 1 1/8" thick top with a Plastic Laminate top surface.

All Metal legs are coated electrostatically with an epoxy powder coat paint.

NOTES:
 * Table heights of 25" (children), 27" (youth), and 32" (wheelchair) are available by request.
 * Color of Metal Paint must be specified at the time of order.
 * Caster Leg options are recommended for Reading/Multipurpose Tables options and not meant to be used for stationary computer workstations.
 * For all tables with casters legs, only 2 legs will have casters, and the other legs will have levelers. This will create a "wheelbarrow" style of table which will ensure ease of mobility.
 * Color of the Caster Option must be specified at the time of order.

Edge Option:



Metal Leg Options:

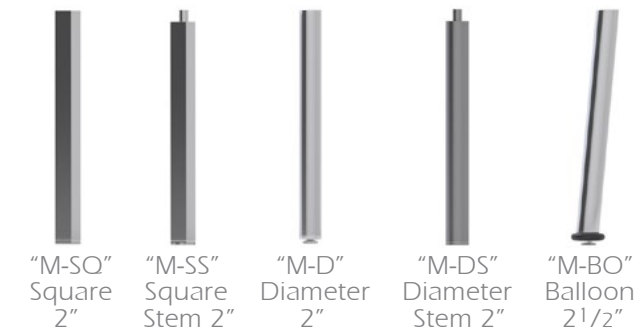

Wood Leg Options:

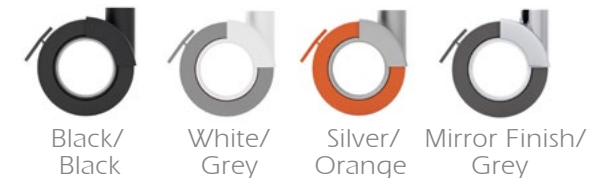
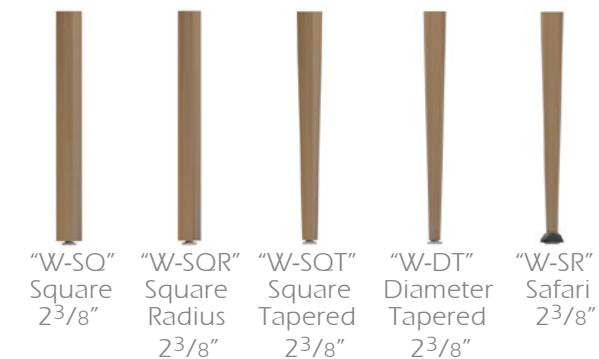

"MC" Caster Option:
 Available on all Metal Legs ONLY, with exception of the Balloon leg and Metal Bases.

MODEL NUMBER
PRODUCT
WIDTH DEPTH HEIGHT
PRICE
DESCRIPTION

*Shown Above:
TB-4824-DBN-M-D



*Rectangle Table Shape

MODEL NUMBER	PRODUCT	WIDTH	DEPTH	HEIGHT	PRICE
	Rectangle Table, 48" Width, 24" Depth	48"	24"	29"	
	DROPPED BULLNOSE Edge;				
	with WOOD Leg Option:	48"	24"	29"	
TB-4824-DBN-W-SQ	Square				\$ 1,281
TB-4824-DBN-W-SQR	Square Radius				\$ 1,281
TB-4824-DBN-W-SQT	Square Tapered				\$ 1,469
TB-4824-DBN-W-DT	Diameter Tapered				\$ 1,631
TB-4824-DBN-W-SR	Safari				\$ 1,644
	with METAL Leg Option:	48"	24"	29"	
TB-4824-DBN-M-SQ	Square				\$ 1,200
TB-4824-DBN-M-SS	Square & Stem				\$ 1,725
TB-4824-DBN-M-D	Diameter				\$ 1,200
TB-4824-DBN-M-DS	Diameter & Stem				\$ 1,725
TB-4824-DBN-M-BO	Balloon				\$ 1,331
TB-4824-DBN-MC-SQ	Square with Casters				\$ 1,481
TB-4824-DBN-MC-SS	Square & Stem with Casters				\$ 2,013
TB-4824-DBN-MC-D	Diameter with Casters				\$ 1,481
TB-4824-DBN-MC-DS	Diameter & Stem with Casters				\$ 2,013
	Rectangle Table, 48" Width, 30" Depth	48"	30"	29"	
	DROPPED BULLNOSE Edge;				
	with WOOD Leg Option:	48"	30"	29"	
TB-4830-DBN-W-SQ	Square				\$ 1,331
TB-4830-DBN-W-SQR	Square Radius				\$ 1,331
TB-4830-DBN-W-SQT	Square Tapered				\$ 1,525
TB-4830-DBN-W-DT	Diameter Tapered				\$ 1,688
TB-4830-DBN-W-SR	Safari				\$ 1,694
	with METAL Leg Option:	48"	30"	29"	
TB-4830-DBN-M-SQ	Square				\$ 1,250
TB-4830-DBN-M-SS	Square & Stem				\$ 1,781
TB-4830-DBN-M-D	Diameter				\$ 1,250
TB-4830-DBN-M-DS	Diameter & Stem				\$ 1,781
TB-4830-DBN-M-BO	Balloon				\$ 1,381
TB-4830-DBN-MC-SQ	Square with Casters				\$ 1,538
TB-4830-DBN-MC-SS	Square & Stem with Casters				\$ 2,063
TB-4830-DBN-MC-D	Diameter with Casters				\$ 1,538
TB-4830-DBN-MC-DS	Diameter & Stem with Casters				\$ 2,063

Each Table Top is constructed using a 1 1/8" thick top with a Plastic Laminate top surface.

All Metal legs are coated electrostatically with an epoxy powder coat paint.

NOTES:

- * Table heights of 25" (children), 27" (youth), and 32" (wheelchair) are available by request.
- * Color of Metal Paint must be specified at the time of order.
- * Caster Leg options are recommended for Reading/Multipurpose Tables options and not meant to be used for stationary computer workstations.
- * For all tables with casters legs, only 2 legs will have casters, and the other legs will have levelers. This will create a "wheelbarrow" style of table which will ensure ease of mobility.
- * Color of the Caster Option must be specified at the time of order.

Edge Option:

"DBN"

3/4" Dropped Bullnoses Edge

Metal Leg Options:



"M-SQ" Square 2"
"M-SS" Square Stem 2"
"M-D" Diameter 2"
"M-DS" Diameter Stem 2"
"M-BO" Balloon 2 1/2"

Wood Leg Options:

"W-SQ" Square 2 3/8"
"W-SQR" Square Radius 2 3/8"
"W-SQT" Square Tapered 2 3/8"
"W-DT" Diameter Tapered 2 3/8"
"W-SR" Safari 2 3/8"



"MC" Caster Option:
Available on all Metal Legs ONLY, with exception of the Balloon leg and Metal Bases.

MODEL NUMBER	PRODUCT	WIDTH	DEPTH	HEIGHT	PRICE	DESCRIPTION
	Rectangle Table, 48" Width, 24" Depth	48"	24"	29"		Each Table Top is constructed using a 1 1/8" thick top with a Plastic Laminate top surface. All Metal legs are coated electrostatically with an epoxy powder coat paint.
	DROPPED CHAMFERED Edge;					
*Shown Above: TB-4824-DCH-M-D	with WOOD Leg Option:	48"	24"	29"		NOTES: * Table heights of 25" (children), 27" (youth), and 32" (wheelchair) are available by request. * Color of Metal Paint must be specified at the time of order. * Caster Leg options are recommended for Reading/Multipurpose Tables options and not meant to be used for stationary computer workstations. * For all tables with casters legs, only 2 legs will have casters, and the other legs will have levelers. This will create a "wheelbarrow" style of table which will ensure ease of mobility. * Color of the Caster Option must be specified at the time of order.
	TB-4824-DCH-W-SQ Square				\$ 1,281	
	TB-4824-DCH-W-SQR Square Radius				\$ 1,281	
	TB-4824-DCH-W-SQT Square Tapered				\$ 1,469	
	TB-4824-DCH-W-DT Diameter Tapered				\$ 1,631	
	TB-4824-DCH-W-SR Safari				\$ 1,644	
	with METAL Leg Option:	48"	24"	29"		
	TB-4824-DCH-M-SQ Square				\$ 1,200	
	TB-4824-DCH-M-SS Square & Stem				\$ 1,725	
	TB-4824-DCH-M-D Diameter				\$ 1,200	
	TB-4824-DCH-M-DS Diameter & Stem				\$ 1,725	
	TB-4824-DCH-M-BO Balloon				\$ 1,331	
	TB-4824-DCH-MC-SQ Square with Casters				\$ 1,481	
	TB-4824-DCH-MC-SS Square & Stem with Casters				\$ 2,013	
	TB-4824-DCH-MC-D Diameter with Casters				\$ 1,481	
	TB-4824-DCH-MC-DS Diameter & Stem with Casters				\$ 2,013	
						
*Rectangle Table Shape						
	Rectangle Table, 48" Width, 30" Depth	48"	30"	29"		Each Table Top is constructed using a 1 1/8" thick top with a Plastic Laminate top surface. All Metal legs are coated electrostatically with an epoxy powder coat paint.
	DROPPED CHAMFERED Edge;					
	with WOOD Leg Option:	48"	30"	29"		NOTES: * Table heights of 25" (children), 27" (youth), and 32" (wheelchair) are available by request. * Color of Metal Paint must be specified at the time of order. * Caster Leg options are recommended for Reading/Multipurpose Tables options and not meant to be used for stationary computer workstations. * For all tables with casters legs, only 2 legs will have casters, and the other legs will have levelers. This will create a "wheelbarrow" style of table which will ensure ease of mobility. * Color of the Caster Option must be specified at the time of order.
	TB-4830-DCH-W-SQ Square				\$ 1,331	
	TB-4830-DCH-W-SQR Square Radius				\$ 1,331	
	TB-4830-DCH-W-SQT Square Tapered				\$ 1,525	
	TB-4830-DCH-W-DT Diameter Tapered				\$ 1,688	
	TB-4830-DCH-W-SR Safari				\$ 1,694	
	with METAL Leg Option:	48"	30"	29"		
	TB-4830-DCH-M-SQ Square				\$ 1,250	
	TB-4830-DCH-M-SS Square & Stem				\$ 1,781	
	TB-4830-DCH-M-D Diameter				\$ 1,250	
	TB-4830-DCH-M-DS Diameter & Stem				\$ 1,781	
	TB-4830-DCH-M-BO Balloon				\$ 1,381	
	TB-4830-DCH-MC-SQ Square with Casters				\$ 1,538	
	TB-4830-DCH-MC-SS Square & Stem with Casters				\$ 2,063	
	TB-4830-DCH-MC-D Diameter with Casters				\$ 1,538	
	TB-4830-DCH-MC-DS Diameter & Stem with Casters				\$ 2,063	

Edge Option:



"DCH"
5/8" Dropped Chamfered Edge

Metal Leg Options:

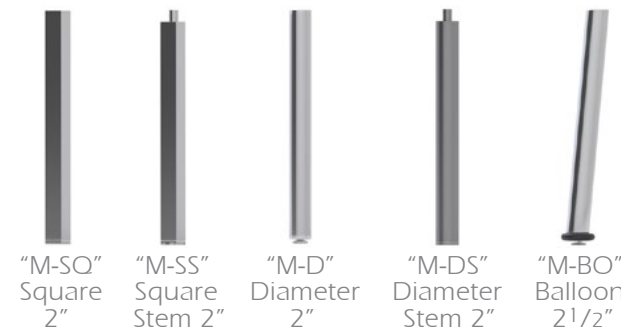

Wood Leg Options:

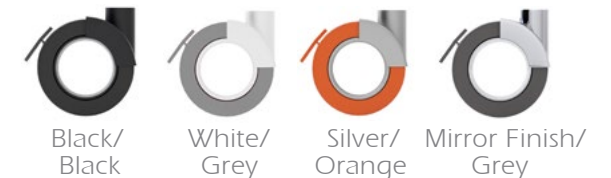
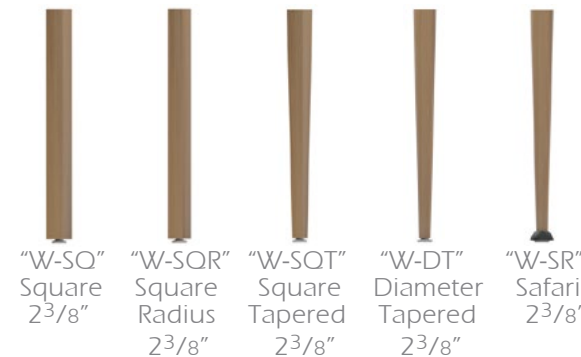

"MC" Caster Option:
Available on all Metal Legs ONLY, with exception of the Balloon leg and Metal Bases.

MODEL NUMBER	PRODUCT	WIDTH	DEPTH	HEIGHT	PRICE	DESCRIPTION
	Rectangle Table, 48" Width, 24" Depth	48"	24"	29"		Each Table Top is constructed using a 1 1/8" thick top with a Plastic Laminate top surface.
	ALUMINUM Edge;					All Metal legs are coated electrostatically with an epoxy powder coat paint.
	with WOOD Leg Option:	48"	24"	29"		NOTES: * Table heights of 25" (children), 27" (youth), and 32" (wheelchair) are available by request. * Color of Metal Paint must be specified at the time of order. * Caster Leg options are recommended for Reading/Multipurpose Tables options and not meant to be used for stationary computer workstations. * For all tables with casters legs, only 2 legs will have casters, and the other legs will have levelers. This will create a "wheelbarrow" style of table which will ensure ease of mobility. * Color of the Caster Option must be specified at the time of order.
TB-4824-AL-W-SQ	Square				\$ 1,138	
TB-4824-AL-W-SQR	Square Radius				\$ 1,138	
TB-4824-AL-W-SQT	Square Tapered				\$ 1,331	
TB-4824-AL-W-DT	Diameter Tapered				\$ 1,481	
TB-4824-AL-W-SR	Safari				\$ 1,494	
	with METAL Leg Option:	48"	24"	29"		
TB-4824-AL-M-SQ	Square				\$ 1,056	
TB-4824-AL-M-SS	Square & Stem				\$ 1,588	
TB-4824-AL-M-D	Diameter				\$ 1,056	
TB-4824-AL-M-DS	Diameter & Stem				\$ 1,588	
TB-4824-AL-M-BO	Balloon				\$ 1,188	
TB-4824-AL-MC-SQ	Square with Casters				\$ 1,338	
TB-4824-AL-MC-SS	Square & Stem with Casters				\$ 1,869	
TB-4824-AL-MC-D	Diameter with Casters				\$ 1,338	
TB-4824-AL-MC-DS	Diameter & Stem with Casters				\$ 1,869	
	Rectangle Table, 48" Width, 30" Depth	48"	30"	29"		
	ALUMINUM Edge;					
	with WOOD Leg Option:	48"	30"	29"		
TB-4830-AL-W-SQ	Square				\$ 1,181	
TB-4830-AL-W-SQR	Square Radius				\$ 1,181	
TB-4830-AL-W-SQT	Square Tapered				\$ 1,369	
TB-4830-AL-W-DT	Diameter Tapered				\$ 1,531	
TB-4830-AL-W-SR	Safari				\$ 1,544	
	with METAL Leg Option:	48"	30"	29"		
TB-4830-AL-M-SQ	Square				\$ 1,100	
TB-4830-AL-M-SS	Square & Stem				\$ 1,625	
TB-4830-AL-M-D	Diameter				\$ 1,100	
TB-4830-AL-M-DS	Diameter & Stem				\$ 1,625	
TB-4830-AL-M-BO	Balloon				\$ 1,231	
TB-4830-AL-MC-SQ	Square with Casters				\$ 1,381	
TB-4830-AL-MC-SS	Square & Stem with Casters				\$ 1,913	
TB-4830-AL-MC-D	Diameter with Casters				\$ 1,381	
TB-4830-AL-MC-DS	Diameter & Stem with Casters				\$ 1,913	

*Shown Above:
TB-4824-AL-M-D



*Rectangle Table Shape

Edge Option:



3mm Aluminum Edge *All table corners will be given a 6-inch radius for this edge option.

Metal Leg Options:

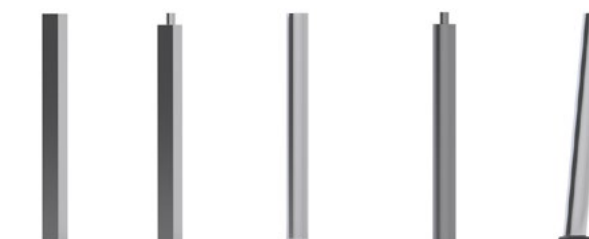

"M-SQ" Square 2"
"M-SS" Square Stem 2"
"M-D" Diameter 2"
"M-DS" Diameter Stem 2"
"M-BO" Balloon 2 1/2"

Wood Leg Options:



"W-SQ" Square 2 3/8"
"W-SQR" Square Radius 2 3/8"
"W-SQT" Square Tapered 2 3/8"
"W-DT" Diameter Tapered 2 3/8"
"W-SR" Safari 2 3/8"



Black/Black White/Grey Silver/Orange Mirror Finish/Grey

"MC" Caster Option:
Available on all Metal Legs ONLY, with exception of the Balloon leg and Metal Bases.

MODEL NUMBER
PRODUCT
WIDTH DEPTH HEIGHT
PRICE
DESCRIPTION

*Shown Above:
TB-6024-AC-M-D



*Rectangle Table Shape

MODEL NUMBER	PRODUCT	WIDTH	DEPTH	HEIGHT
	Rectangle Table, 60" Width, 24" Depth	60"	24"	29"
	ACRYLIC Edge;			
	with WOOD Leg Option:	60"	24"	29"
TB-6024-AC-W-SQ	Square			
TB-6024-AC-W-SQR	Square Radius			
TB-6024-AC-W-SQT	Square Tapered			
TB-6024-AC-W-DT	Diameter Tapered			
TB-6024-AC-W-SR	Safari			
	with METAL Leg Option:	60"	24"	29"
TB-6024-AC-M-SQ	Square			
TB-6024-AC-M-SS	Square & Stem			
TB-6024-AC-M-D	Diameter			
TB-6024-AC-M-DS	Diameter & Stem			
TB-6024-AC-M-BO	Balloon			
TB-6024-AC-MC-SQ	Square with Casters			
TB-6024-AC-MC-SS	Square & Stem with Casters			
TB-6024-AC-MC-D	Diameter with Casters			
TB-6024-AC-MC-DS	Diameter & Stem with Casters			
TB-6024-AC-FL	Flip Leg (for Nesting Tables)			
TB-6024-AC-FD	Folding Leg			
	Rectangle Table, 60" Width, 30" Depth	60"	30"	29"
	ACRYLIC Edge;			
	with WOOD Leg Option:	60"	30"	29"
TB-6030-AC-W-SQ	Square			
TB-6030-AC-W-SQR	Square Radius			
TB-6030-AC-W-SQT	Square Tapered			
TB-6030-AC-W-DT	Diameter Tapered			
TB-6030-AC-W-SR	Safari			
	with METAL Leg Option:	60"	30"	29"
TB-6030-AC-M-SQ	Square			
TB-6030-AC-M-SS	Square & Stem			
TB-6030-AC-M-D	Diameter			
TB-6030-AC-M-DS	Diameter & Stem			
TB-6030-AC-M-BO	Balloon			
TB-6030-AC-MC-SQ	Square with Casters			
TB-6030-AC-MC-SS	Square & Stem with Casters			
TB-6030-AC-MC-D	Diameter with Casters			
TB-6030-AC-MC-DS	Diameter & Stem with Casters			
TB-6030-AC-FL	Flip Leg (for Nesting Tables)			
TB-6030-AC-FD	Folding Leg			

\$ 1,088
\$ 1,088
\$ 1,275
\$ 1,438
\$ 1,450

\$ 1,006
\$ 1,531
\$ 1,006
\$ 1,531
\$ 1,131
\$ 1,288
\$ 1,819
\$ 1,288
\$ 1,819
\$ 2,150
\$ 2,150

Each Table Top is constructed using a 1" thick top with a Plastic Laminate top surface.

All Metal legs are coated electrostatically with an epoxy powder coat paint.

NOTES:

- * Table heights of 25" (children), 27" (youth), and 32" (wheelchair) are available by request.
- * Color of Metal Paint must be specified at the time of order.
- * Caster Leg options are recommended for Reading/Multipurpose Tables options and not meant to be used for stationary computer workstations.
- * For all tables with casters legs, only 2 legs will have casters, and the other legs will have levelers. This will create a "wheelbarrow" style of table which will ensure ease of mobility.
- * Color of the Caster Option must be specified at the time of order.
- * For the Flip OR Fold Leg option, one T-based leg comes with 2 hidden casters as shown in the image below.

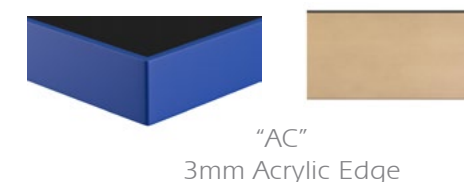
Edge Option:

"AC"
3mm Acrylic Edge

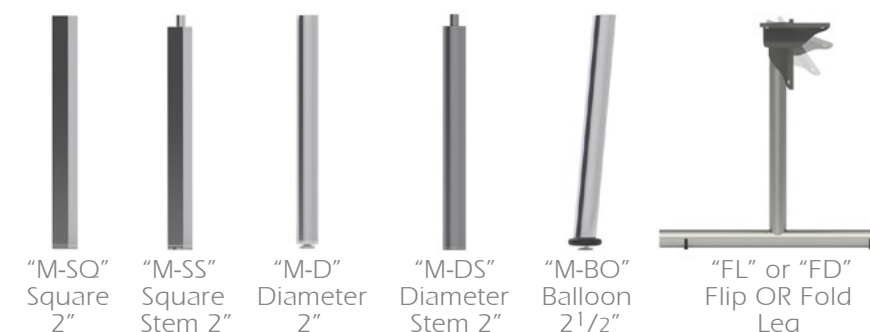
Metal Leg Options:

"M-SQ" Square 2"
"M-SS" Square Stem 2"
"M-D" Diameter 2"
"M-DS" Diameter Stem 2"
"M-BO" Balloon 2 1/2"
"FL" or "FD" Flip OR Fold Leg

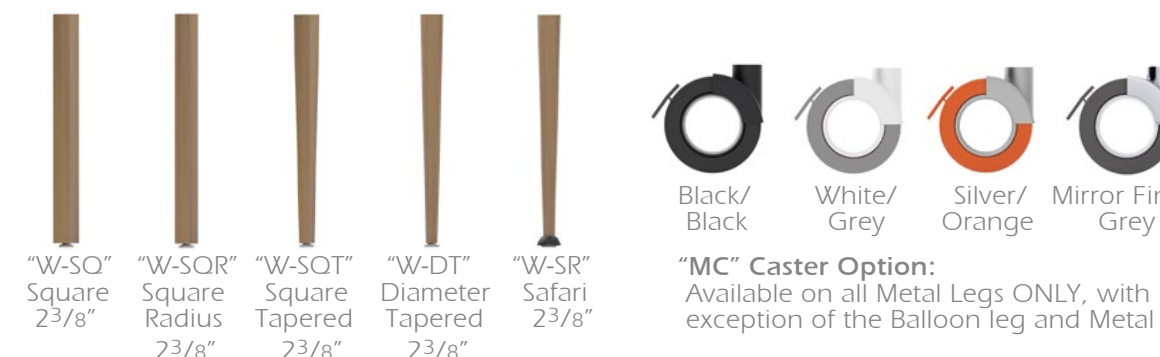
Wood Leg Options:

"W-SQ" Square 2 3/8"
"W-SQR" Square Radius 2 3/8"
"W-SQT" Square Tapered 2 3/8"
"W-DT" Diameter Tapered 2 3/8"
"W-SR" Safari 2 3/8"

Black/Black White/Grey Silver/Orange Mirror Finish/Grey

"MC" Caster Option:
Available on all Metal Legs ONLY, with exception of the Balloon leg and Metal Bases.

MODEL NUMBER

PRODUCT

WIDTH DEPTH HEIGHT

PRICE

DESCRIPTION



*Shown Above:
TB-6024-AC-M-D



*Rectangle Table Shape

MODEL NUMBER	PRODUCT	WIDTH	DEPTH	HEIGHT
	Rectangle Table, 60" Width, 36" Depth	60"	36"	29"
	ACRYLIC Edge;			
	with WOOD Leg Option:	60"	36"	29"
TB-6036-AC-W-SQ	Square			
TB-6036-AC-W-SQR	Square Radius			
TB-6036-AC-W-SQT	Square Tapered			
TB-6036-AC-W-DT	Diameter Tapered			
TB-6036-AC-W-SR	Safari			
	with METAL Leg Option:	60"	36"	29"
TB-6036-AC-M-SQ	Square			
TB-6036-AC-M-SS	Square & Stem			
TB-6036-AC-M-D	Diameter			
TB-6036-AC-M-DS	Diameter & Stem			
TB-6036-AC-M-BO	Balloon			
TB-6036-AC-MC-SQ	Square with Casters			
TB-6036-AC-MC-SS	Square & Stem with Casters			
TB-6036-AC-MC-D	Diameter with Casters			
TB-6036-AC-MC-DS	Diameter & Stem with Casters			
TB-6036-AC-FL	Flip Leg (for Nesting Tables)			
TB-6036-AC-FD	Folding Leg			

Each Table Top is constructed using a 1" thick top with a Plastic Laminate top surface.

All Metal legs are coated electrostatically with an epoxy powder coat paint.

NOTES:

- * Table heights of 25" (children), 27" (youth), and 32" (wheelchair) are available by request.
- * Color of Metal Paint must be specified at the time of order.
- * Caster Leg options are recommended for Reading/Multipurpose Tables options and not meant to be used for stationary computer workstations.
- * For all tables with casters legs, only 2 legs will have casters, and the other legs will have levelers. This will create a "wheelbarrow" style of table which will ensure ease of mobility.
- * Color of the Caster Option must be specified at the time of order.
- * For the Flip OR Fold Leg option, one T-based leg comes with 2 hidden casters as shown in the image below.

\$ 1,269
\$ 1,269
\$ 1,463
\$ 1,619
\$ 2,063
\$ 1,188
\$ 1,725
\$ 1,188
\$ 1,725
\$ 1,319
\$ 1,475
\$ 2,000
\$ 1,475
\$ 2,000
\$ 2,256
\$ 2,256

Edge Option:

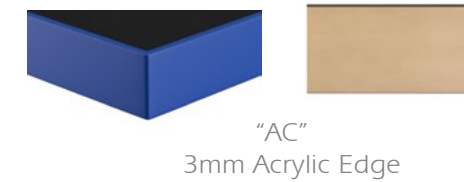

Metal Leg Options:



Wood Leg Options:

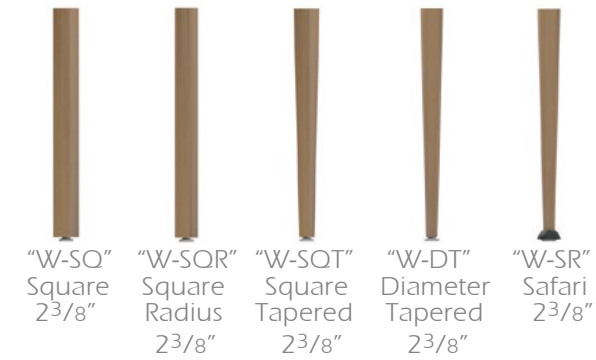

"MC" Caster Option:
Available on all Metal Legs ONLY, with exception of the Balloon leg and Metal Bases.

MODEL NUMBER
PRODUCT
WIDTH DEPTH HEIGHT
PRICE
DESCRIPTION

*Shown Above:
TB-6024-SQ-M-D



*Rectangle Table Shape

MODEL NUMBER	PRODUCT	WIDTH	DEPTH	HEIGHT
	Rectangle Table, 60" Width, 24" Depth	60"	24"	29"
	SQUARE Edge;			
	with WOOD Leg Option:	60"	24"	29"
TB-6024-SQ-W-SQ	Square			
TB-6024-SQ-W-SQR	Square Radius			
TB-6024-SQ-W-SQT	Square Tapered			
TB-6024-SQ-W-DT	Diameter Tapered			
TB-6024-SQ-W-SR	Safari			
	with METAL Leg Option:	60"	24"	29"
TB-6024-SQ-M-SQ	Square			
TB-6024-SQ-M-SS	Square & Stem			
TB-6024-SQ-M-D	Diameter			
TB-6024-SQ-M-DS	Diameter & Stem			
TB-6024-SQ-M-BO	Balloon			
TB-6024-SQ-MC-SQ	Square with Casters			
TB-6024-SQ-MC-SS	Square & Stem with Casters			
TB-6024-SQ-MC-D	Diameter with Casters			
TB-6024-SQ-MC-DS	Diameter & Stem with Casters			
TB-6024-SQ-FL	Flip Leg (for Nesting Tables)			
TB-6024-SQ-FD	Folding Leg			
	Rectangle Table, 60" Width, 30" Depth	60"	30"	29"
	SQUARE Edge;			
	with WOOD Leg Option:	60"	30"	29"
TB-6030-SQ-W-SQ	Square			
TB-6030-SQ-W-SQR	Square Radius			
TB-6030-SQ-W-SQT	Square Tapered			
TB-6030-SQ-W-DT	Diameter Tapered			
TB-6030-SQ-W-SR	Safari			
	with METAL Leg Option:	60"	30"	29"
TB-6030-SQ-M-SQ	Square			
TB-6030-SQ-M-SS	Square & Stem			
TB-6030-SQ-M-D	Diameter			
TB-6030-SQ-M-DS	Diameter & Stem			
TB-6030-SQ-M-BO	Balloon			
TB-6030-SQ-MC-SQ	Square with Casters			
TB-6030-SQ-MC-SS	Square & Stem with Casters			
TB-6030-SQ-MC-D	Diameter with Casters			
TB-6030-SQ-MC-DS	Diameter & Stem with Casters			
TB-6030-SQ-FL	Flip Leg (for Nesting Tables)			
TB-6030-SQ-FD	Folding Leg			

Each Table Top is constructed using a 1 1/8" thick top with a Plastic Laminate top surface.

All Metal legs are coated electrostatically with an epoxy powder coat paint.

NOTES:

- * Table heights of 25" (children), 27" (youth), and 32" (wheelchair) are available by request.
- * Color of Metal Paint must be specified at the time of order.
- * Caster Leg options are recommended for Reading/Multipurpose Tables options and not meant to be used for stationary computer workstations.
- * For all tables with casters legs, only 2 legs will have casters, and the other legs will have levelers. This will create a "wheelbarrow" style of table which will ensure ease of mobility.
- * Color of the Caster Option must be specified at the time of order.
- * For the Flip OR Fold Leg option, one T-based leg comes with 2 hidden casters as shown in the image below.

\$ 1,256
\$ 1,256
\$ 1,450
\$ 1,606
\$ 1,613
\$ 1,175
\$ 1,706
\$ 1,175
\$ 1,706
\$ 1,306
\$ 1,456
\$ 1,988
\$ 1,456
\$ 1,988
\$ 2,306
\$ 2,306

Edge Option:

"SQ"
1/4" Square Edge

Metal Leg Options:

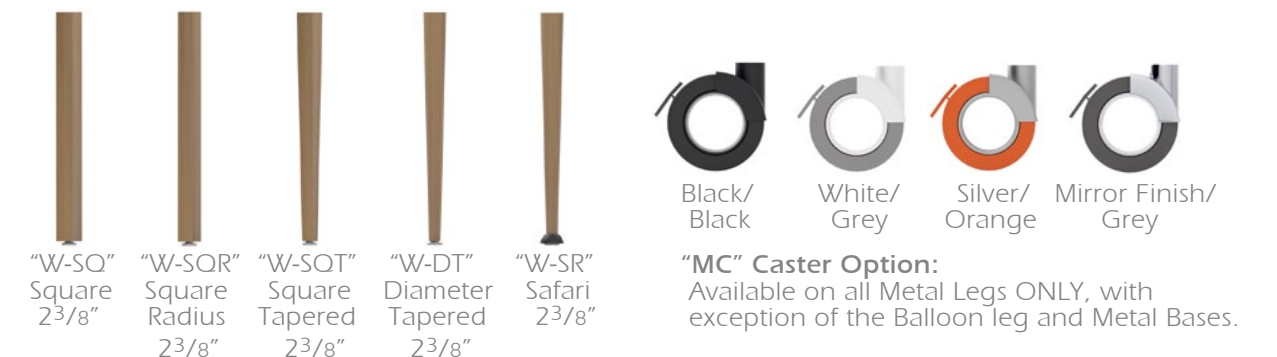
Wood Leg Options:

"MC" Caster Option:
Available on all Metal Legs ONLY, with exception of the Balloon leg and Metal Bases.

MODEL NUMBER

PRODUCT

WIDTH DEPTH HEIGHT

PRICE

DESCRIPTION



*Shown Above:
TB-6024-SQ-M-D



*Rectangle Table Shape

MODEL NUMBER	PRODUCT	WIDTH	DEPTH	HEIGHT
	Rectangle Table, 60" Width, 36" Depth	60"	36"	29"
	SQUARE Edge;			
	with WOOD Leg Option:	60"	36"	29"
TB-6036-SQ-W-SQ	Square			
TB-6036-SQ-W-SQR	Square Radius			
TB-6036-SQ-W-SQT	Square Tapered			
TB-6036-SQ-W-DT	Diameter Tapered			
TB-6036-SQ-W-SR	Safari			
	with METAL Leg Option:	60"	36"	29"
TB-6036-SQ-M-SQ	Square			
TB-6036-SQ-M-SS	Square & Stem			
TB-6036-SQ-M-D	Diameter			
TB-6036-SQ-M-DS	Diameter & Stem			
TB-6036-SQ-M-BO	Balloon			
TB-6036-SQ-MC-SQ	Square with Casters			
TB-6036-SQ-MC-SS	Square & Stem with Casters			
TB-6036-SQ-MC-D	Diameter with Casters			
TB-6036-SQ-MC-DS	Diameter & Stem with Casters			
TB-6036-SQ-FL	Flip Leg (for Nesting Tables)			
TB-6036-SQ-FD	Folding Leg			

Each Table Top is constructed using a 1 1/8" thick top with a Plastic Laminate top surface.

All Metal legs are coated electrostatically with an epoxy powder coat paint.

NOTES:

- * Table heights of 25" (children), 27" (youth), and 32" (wheelchair) are available by request.
- * Color of Metal Paint must be specified at the time of order.
- * Caster Leg options are recommended for Reading/Multipurpose Tables options and not meant to be used for stationary computer workstations.
- * For all tables with casters legs, only 2 legs will have casters, and the other legs will have levelers. This will create a "wheelbarrow" style of table which will ensure ease of mobility.
- * Color of the Caster Option must be specified at the time of order.
- * For the Flip OR Fold Leg option, one T-based leg comes with 2 hidden casters as shown in the image below.

\$ 1,463
\$ 1,463
\$ 1,650
\$ 1,813
\$ 1,825
\$ 1,381
\$ 1,913
\$ 1,381
\$ 1,913
\$ 1,506
\$ 1,663
\$ 2,194
\$ 1,663
\$ 2,194
\$ 2,450
\$ 2,450

Edge Option:



"SQ"
1/4" Square Edge

Metal Leg Options:

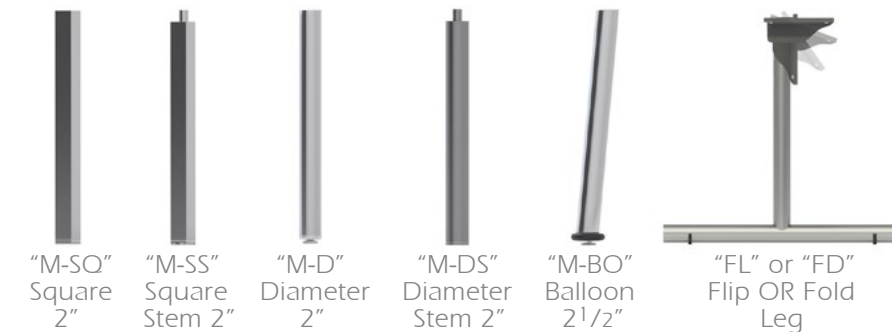

"M-SQ" Square 2"
"M-SS" Square Stem 2"
"M-D" Diameter 2"
"M-DS" Diameter Stem 2"
"M-BO" Balloon 2 1/2"
"FL" or "FD" Flip OR Fold Leg

Wood Leg Options:

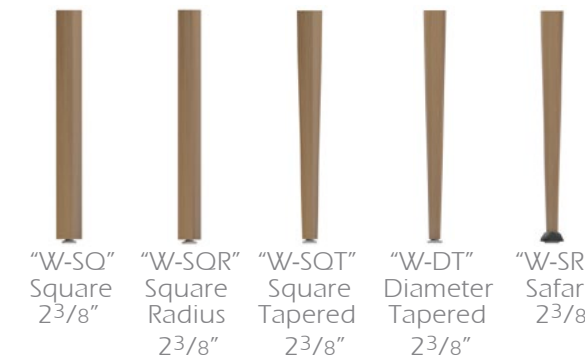

"W-SQ" Square 2 3/8"
"W-SQR" Square Radius 2 3/8"
"W-SQT" Square Tapered 2 3/8"
"W-DT" Diameter Tapered 2 3/8"
"W-SR" Safari 2 3/8"



Black/Black
White/Grey
Silver/Orange
Mirror Finish/Grey

"MC" Caster Option:
Available on all Metal Legs ONLY, with exception of the Balloon leg and Metal Bases.

MODEL NUMBER
PRODUCT
WIDTH DEPTH HEIGHT
PRICE
DESCRIPTION

*Shown Above:
TB-6024-DSQ-M-D



*Rectangle Table Shape

MODEL NUMBER	PRODUCT	WIDTH	DEPTH	HEIGHT	PRICE
	Rectangle Table, 60" Width, 24" Depth	60"	24"	29"	
	DROPPED SQUARE Edge;				
	with WOOD Leg Option:	60"	24"	29"	
TB-6024-DSQ-W-SQ	Square				\$ 1,338
TB-6024-DSQ-W-SQR	Square Radius				\$ 1,338
TB-6024-DSQ-W-SQT	Square Tapered				\$ 1,525
TB-6024-DSQ-W-DT	Diameter Tapered				\$ 1,688
TB-6024-DSQ-W-SR	Safari				\$ 1,700
	with METAL Leg Option:	60"	24"	29"	
TB-6024-DSQ-M-SQ	Square				\$ 1,256
TB-6024-DSQ-M-SS	Square & Stem				\$ 1,788
TB-6024-DSQ-M-D	Diameter				\$ 1,256
TB-6024-DSQ-M-DS	Diameter & Stem				\$ 1,788
TB-6024-DSQ-M-BO	Balloon				\$ 1,388
TB-6024-DSQ-MC-SQ	Square with Casters				\$ 1,544
TB-6024-DSQ-MC-SS	Square & Stem with Casters				\$ 2,069
TB-6024-DSQ-MC-D	Diameter with Casters				\$ 1,544
TB-6024-DSQ-MC-DS	Diameter & Stem with Casters				\$ 2,069
TB-6024-DSQ-FL	Flip Leg (for Nesting Tables)				\$ 2,388
TB-6024-DSQ-FD	Folding Leg				\$ 2,388
	Rectangle Table, 60" Width, 30" Depth	60"	30"	29"	
	DROPPED SQUARE Edge;				
	with WOOD Leg Option:	60"	30"	29"	
TB-6030-DSQ-W-SQ	Square				\$ 1,500
TB-6030-DSQ-W-SQR	Square Radius				\$ 1,500
TB-6030-DSQ-W-SQT	Square Tapered				\$ 1,688
TB-6030-DSQ-W-DT	Diameter Tapered				\$ 1,850
TB-6030-DSQ-W-SR	Safari				\$ 1,863
	with METAL Leg Option:	60"	30"	29"	
TB-6030-DSQ-M-SQ	Square				\$ 1,419
TB-6030-DSQ-M-SS	Square & Stem				\$ 1,944
TB-6030-DSQ-M-D	Diameter				\$ 1,419
TB-6030-DSQ-M-DS	Diameter & Stem				\$ 1,944
TB-6030-DSQ-M-BO	Balloon				\$ 1,544
TB-6030-DSQ-MC-SQ	Square with Casters				\$ 1,700
TB-6030-DSQ-MC-SS	Square & Stem with Casters				\$ 2,231
TB-6030-DSQ-MC-D	Diameter with Casters				\$ 1,700
TB-6030-DSQ-MC-DS	Diameter & Stem with Casters				\$ 2,231
TB-6030-DSQ-FL	Flip Leg (for Nesting Tables)				\$ 2,675
TB-6030-DSQ-FD	Folding Leg				\$ 2,675

Each Table Top is constructed using a 1 1/8" thick top with a Plastic Laminate top surface.

All Metal legs are coated electrostatically with an epoxy powder coat paint.

NOTES:

- * Table heights of 25" (children), 27" (youth), and 32" (wheelchair) are available by request.
- * Color of Metal Paint must be specified at the time of order.
- * Caster Leg options are recommended for Reading/Multipurpose Tables options and not meant to be used for stationary computer workstations.
- * For all tables with casters legs, only 2 legs will have casters, and the other legs will have levelers. This will create a "wheelbarrow" style of table which will ensure ease of mobility.
- * Color of the Caster Option must be specified at the time of order.
- * For the Flip OR Fold Leg option, one T-based leg comes with 2 hidden casters as shown in the image below.

Edge Option:

"DSQ"
3/4" Dropped Square Edge

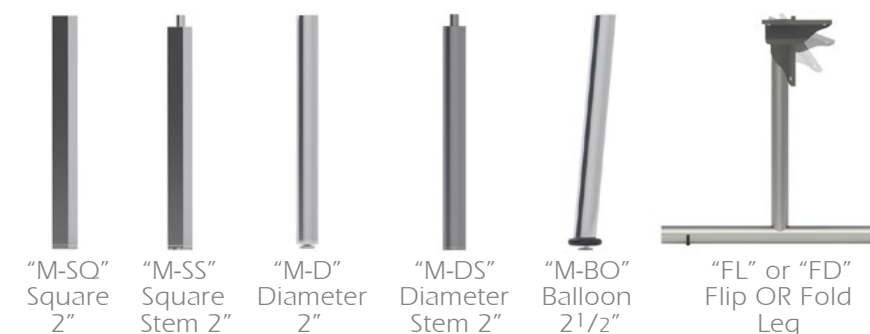
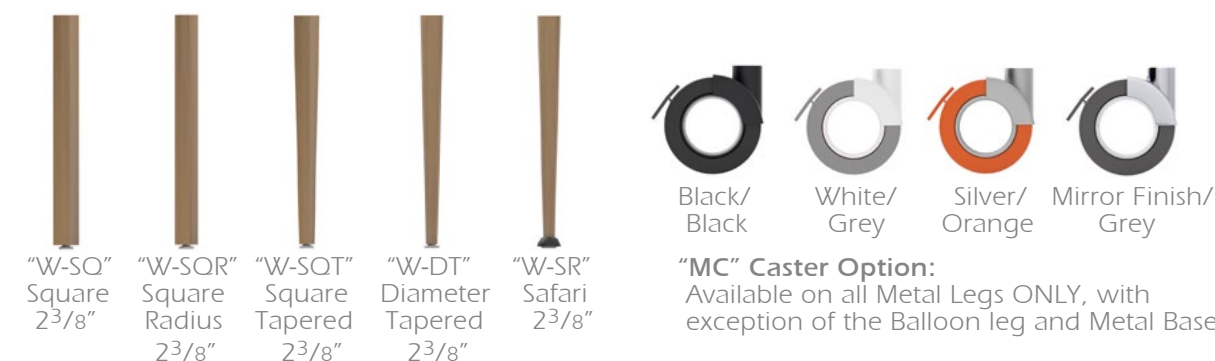
Metal Leg Options:

Wood Leg Options:

"MC" Caster Option:
Available on all Metal Legs ONLY, with exception of the Balloon leg and Metal Bases.

MODEL NUMBER

PRODUCT

WIDTH DEPTH HEIGHT

PRICE

DESCRIPTION



*Shown Above:
TB-6024-DSQ-M-D



*Rectangle Table Shape

MODEL NUMBER	PRODUCT	WIDTH	DEPTH	HEIGHT
	Rectangle Table, 60" Width, 36" Depth	60"	36"	29"
	DROPPED SQUARE Edge;			
	with WOOD Leg Option:	60"	36"	29"
TB-6036-DSQ-W-SQ	Square			
TB-6036-DSQ-W-SQR	Square Radius			
TB-6036-DSQ-W-SQT	Square Tapered			
TB-6036-DSQ-W-DT	Diameter Tapered			
TB-6036-DSQ-W-SR	Safari			
	with METAL Leg Option:	60"	36"	29"
TB-6036-DSQ-M-SQ	Square			
TB-6036-DSQ-M-SS	Square & Stem			
TB-6036-DSQ-M-D	Diameter			
TB-6036-DSQ-M-DS	Diameter & Stem			
TB-6036-DSQ-M-BO	Balloon			
TB-6036-DSQ-MC-SQ	Square with Casters			
TB-6036-DSQ-MC-SS	Square & Stem with Casters			
TB-6036-DSQ-MC-D	Diameter with Casters			
TB-6036-DSQ-MC-DS	Diameter & Stem with Casters			
TB-6036-DSQ-FL	Flip Leg (for Nesting Tables)			
TB-6036-DSQ-FD	Folding Leg			

Each Table Top is constructed using a 1 1/8" thick top with a Plastic Laminate top surface.

All Metal legs are coated electrostatically with an epoxy powder coat paint.

NOTES:

- * Table heights of 25" (children), 27" (youth), and 32" (wheelchair) are available by request.
- * Color of Metal Paint must be specified at the time of order.
- * Caster Leg options are recommended for Reading/Multipurpose Tables options and not meant to be used for stationary computer workstations.
- * For all tables with casters legs, only 2 legs will have casters, and the other legs will have levelers. This will create a "wheelbarrow" style of table which will ensure ease of mobility.
- * Color of the Caster Option must be specified at the time of order.
- * For the Flip OR Fold Leg option, one T-based leg comes with 2 hidden casters as shown in the image below.

\$ 1,563
\$ 1,563
\$ 1,750
\$ 1,913
\$ 1,925
\$ 1,481
\$ 2,013
\$ 1,481
\$ 2,013
\$ 1,606
\$ 1,763
\$ 2,294
\$ 1,763
\$ 2,294
\$ 2,550
\$ 2,550

Edge Option:



Metal Leg Options:



Wood Leg Options:

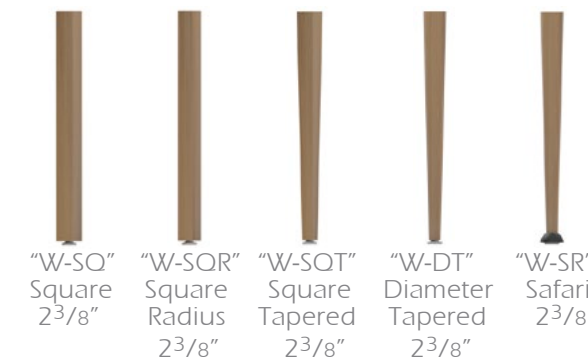

"MC" Caster Option:
Available on all Metal Legs ONLY, with exception of the Balloon leg and Metal Bases.

MODEL NUMBER

PRODUCT

WIDTH DEPTH HEIGHT

PRICE

DESCRIPTION



*Shown Above:
TB-6024-DBN-M-D



*Rectangle Table Shape

MODEL NUMBER	PRODUCT	WIDTH	DEPTH	HEIGHT	PRICE
	Rectangle Table, 60" Width, 24" Depth	60"	24"	29"	
	DROPPED BULLNOSE Edge;				
	with WOOD Leg Option:	60"	24"	29"	
TB-6024-DBN-W-SQ	Square				\$ 1,350
TB-6024-DBN-W-SQR	Square Radius				\$ 1,350
TB-6024-DBN-W-SQT	Square Tapered				\$ 1,544
TB-6024-DBN-W-DT	Diameter Tapered				\$ 1,706
TB-6024-DBN-W-SR	Safari				\$ 1,713
	with METAL Leg Option:	60"	24"	29"	
TB-6024-DBN-M-SQ	Square				\$ 1,269
TB-6024-DBN-M-SS	Square & Stem				\$ 1,806
TB-6024-DBN-M-D	Diameter				\$ 1,269
TB-6024-DBN-M-DS	Diameter & Stem				\$ 1,806
TB-6024-DBN-M-BO	Balloon				\$ 1,400
TB-6024-DBN-MC-SQ	Square with Casters				\$ 1,556
TB-6024-DBN-MC-SS	Square & Stem with Casters				\$ 2,081
TB-6024-DBN-MC-D	Diameter with Casters				\$ 1,556
TB-6024-DBN-MC-DS	Diameter & Stem with Casters				\$ 2,081
TB-6024-DBN-FL	Flip Leg (for Nesting Tables)				\$ 2,400
TB-6024-DBN-FD	Folding Leg				\$ 2,400
	Rectangle Table, 60" Width, 30" Depth	60"	30"	29"	
	DROPPED BULLNOSE Edge;				
	with WOOD Leg Option:	60"	30"	29"	
TB-6030-DBN-W-SQ	Square				\$ 1,513
TB-6030-DBN-W-SQR	Square Radius				\$ 1,513
TB-6030-DBN-W-SQT	Square Tapered				\$ 1,706
TB-6030-DBN-W-DT	Diameter Tapered				\$ 1,863
TB-6030-DBN-W-SR	Safari				\$ 1,875
	with METAL Leg Option:	60"	30"	29"	
TB-6030-DBN-M-SQ	Square				\$ 1,431
TB-6030-DBN-M-SS	Square & Stem				\$ 1,963
TB-6030-DBN-M-D	Diameter				\$ 1,431
TB-6030-DBN-M-DS	Diameter & Stem				\$ 1,963
TB-6030-DBN-M-BO	Balloon				\$ 1,563
TB-6030-DBN-MC-SQ	Square with Casters				\$ 1,713
TB-6030-DBN-MC-SS	Square & Stem with Casters				\$ 2,244
TB-6030-DBN-MC-D	Diameter with Casters				\$ 1,713
TB-6030-DBN-MC-DS	Diameter & Stem with Casters				\$ 2,244
TB-6030-DBN-FL	Flip Leg (for Nesting Tables)				\$ 2,688
TB-6030-DBN-FD	Folding Leg				\$ 2,688

Each Table Top is constructed using a 1 1/8" thick top with a Plastic Laminate top surface.

All Metal legs are coated electrostatically with an epoxy powder coat paint.

NOTES:

- * Table heights of 25" (children), 27" (youth), and 32" (wheelchair) are available by request.
- * Color of Metal Paint must be specified at the time of order.
- * Caster Leg options are recommended for Reading/Multipurpose Tables options and not meant to be used for stationary computer workstations.
- * For all tables with casters legs, only 2 legs will have casters, and the other legs will have levelers. This will create a "wheelbarrow" style of table which will ensure ease of mobility.
- * Color of the Caster Option must be specified at the time of order.
- * For the Flip OR Fold Leg option, one T-based leg comes with 2 hidden casters as shown in the image below.

Edge Option:



"DBN"
3/4" Dropped Bullnoses Edge

Metal Leg Options:



"M-SQ" Square 2"
"M-SS" Square Stem 2"
"M-D" Diameter 2"
"M-DS" Diameter Stem 2"
"M-BO" Balloon 2 1/2"
"FL" or "FD" Flip OR Fold Leg

Wood Leg Options:

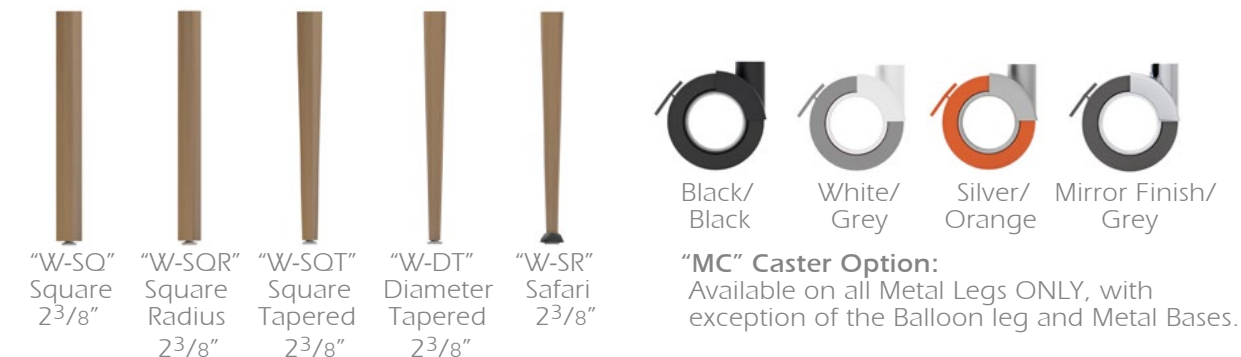

"W-SQ" Square 2 3/8"
"W-SQR" Square Radius 2 3/8"
"W-SQT" Square Tapered 2 3/8"
"W-DT" Diameter Tapered 2 3/8"
"W-SR" Safari 2 3/8"

"MC" Caster Option:
Available on all Metal Legs ONLY, with exception of the Balloon leg and Metal Bases.
Black/Black White/Grey Silver/Orange Mirror Finish/Grey

MODEL NUMBER

PRODUCT

WIDTH DEPTH HEIGHT

PRICE

DESCRIPTION



*Shown Above:
TB-6024-DBN-M-D



*Rectangle Table Shape

MODEL NUMBER	PRODUCT	WIDTH	DEPTH	HEIGHT
	Rectangle Table, 60" Width, 36" Depth	60"	36"	29"
	DROPPED BULLNOSE Edge;			
	with WOOD Leg Option:	60"	36"	29"
TB-6036-DBN-W-SQ	Square			
TB-6036-DBN-W-SQR	Square Radius			
TB-6036-DBN-W-SQT	Square Tapered			
TB-6036-DBN-W-DT	Diameter Tapered			
TB-6036-DBN-W-SR	Safari			
	with METAL Leg Option:	60"	36"	29"
TB-6036-DBN-M-SQ	Square			
TB-6036-DBN-M-SS	Square & Stem			
TB-6036-DBN-M-D	Diameter			
TB-6036-DBN-M-DS	Diameter & Stem			
TB-6036-DBN-M-BO	Balloon			
TB-6036-DBN-MC-SQ	Square with Casters			
TB-6036-DBN-MC-SS	Square & Stem with Casters			
TB-6036-DBN-MC-D	Diameter with Casters			
TB-6036-DBN-MC-DS	Diameter & Stem with Casters			
TB-6036-DBN-FL	Flip Leg (for Nesting Tables)			
TB-6036-DBN-FD	Folding Leg			

Each Table Top is constructed using a 1 1/8" thick top with a Plastic Laminate top surface.

All Metal legs are coated electrostatically with an epoxy powder coat paint.

NOTES:

- * Table heights of 25" (children), 27" (youth), and 32" (wheelchair) are available by request.
- * Color of Metal Paint must be specified at the time of order.
- * Caster Leg options are recommended for Reading/Multipurpose Tables options and not meant to be used for stationary computer workstations.
- * For all tables with casters legs, only 2 legs will have casters, and the other legs will have levelers. This will create a "wheelbarrow" style of table which will ensure ease of mobility.
- * Color of the Caster Option must be specified at the time of order.
- * For the Flip OR Fold Leg option, one T-based leg comes with 2 hidden casters as shown in the image below.

- \$ 1,575
- \$ 1,575
- \$ 1,763
- \$ 1,925
- \$ 1,938
- \$ 1,494
- \$ 2,025
- \$ 1,494
- \$ 2,025
- \$ 1,625
- \$ 1,781
- \$ 2,306
- \$ 1,781
- \$ 2,306
- \$ 2,563
- \$ 2,563

Edge Option:



Metal Leg Options:



Wood Leg Options:

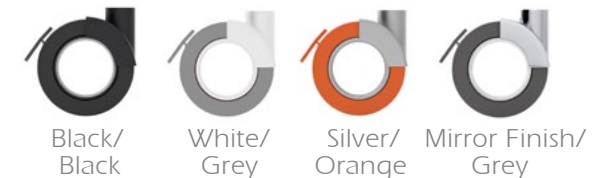
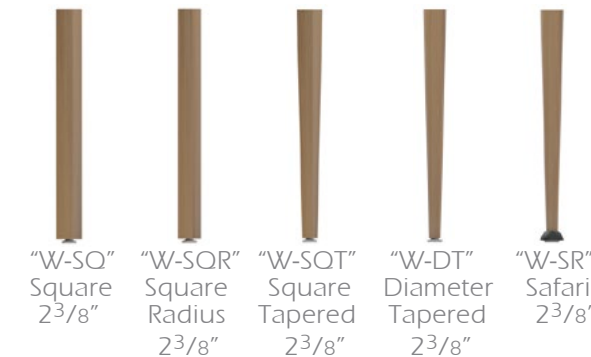

"MC" Caster Option:
Available on all Metal Legs ONLY, with exception of the Balloon leg and Metal Bases.

MODEL NUMBER

PRODUCT

WIDTH DEPTH HEIGHT

PRICE

DESCRIPTION



*Shown Above:
TB-6024-DCH-M-D



*Rectangle Table Shape

MODEL NUMBER	PRODUCT	WIDTH	DEPTH	HEIGHT	PRICE
	Rectangle Table, 60" Width, 24" Depth	60"	24"	29"	
	DROPPED CHAMFERED Edge;				
	with WOOD Leg Option:	60"	24"	29"	
TB-6024-DCH-W-SQ	Square				\$ 1,350
TB-6024-DCH-W-SQR	Square Radius				\$ 1,350
TB-6024-DCH-W-SQT	Square Tapered				\$ 1,544
TB-6024-DCH-W-DT	Diameter Tapered				\$ 1,706
TB-6024-DCH-W-SR	Safari				\$ 1,713
	with METAL Leg Option:	60"	24"	29"	
TB-6024-DCH-M-SQ	Square				\$ 1,269
TB-6024-DCH-M-SS	Square & Stem				\$ 1,806
TB-6024-DCH-M-D	Diameter				\$ 1,269
TB-6024-DCH-M-DS	Diameter & Stem				\$ 1,806
TB-6024-DCH-M-BO	Balloon				\$ 1,400
TB-6024-DCH-MC-SQ	Square with Casters				\$ 1,556
TB-6024-DCH-MC-SS	Square & Stem with Casters				\$ 2,081
TB-6024-DCH-MC-D	Diameter with Casters				\$ 1,556
TB-6024-DCH-MC-DS	Diameter & Stem with Casters				\$ 2,081
TB-6024-DCH-FL	Flip Leg (for Nesting Tables)				\$ 2,400
TB-6024-DCH-FD	Folding Leg				\$ 2,400
	Rectangle Table, 60" Width, 30" Depth	60"	30"	29"	
	DROPPED CHAMFERED Edge;				
	with WOOD Leg Option:	60"	30"	29"	
TB-6030-DCH-W-SQ	Square				\$ 1,513
TB-6030-DCH-W-SQR	Square Radius				\$ 1,513
TB-6030-DCH-W-SQT	Square Tapered				\$ 1,706
TB-6030-DCH-W-DT	Diameter Tapered				\$ 1,863
TB-6030-DCH-W-SR	Safari				\$ 1,875
	with METAL Leg Option:	60"	30"	29"	
TB-6030-DCH-M-SQ	Square				\$ 1,431
TB-6030-DCH-M-SS	Square & Stem				\$ 1,963
TB-6030-DCH-M-D	Diameter				\$ 1,431
TB-6030-DCH-M-DS	Diameter & Stem				\$ 1,963
TB-6030-DCH-M-BO	Balloon				\$ 1,563
TB-6030-DCH-MC-SQ	Square with Casters				\$ 1,713
TB-6030-DCH-MC-SS	Square & Stem with Casters				\$ 2,244
TB-6030-DCH-MC-D	Diameter with Casters				\$ 1,713
TB-6030-DCH-MC-DS	Diameter & Stem with Casters				\$ 2,244
TB-6030-DCH-FL	Flip Leg (for Nesting Tables)				\$ 2,688
TB-6030-DCH-FD	Folding Leg				\$ 2,688

Each Table Top is constructed using a 1 1/8" thick top with a Plastic Laminate top surface.

All Metal legs are coated electrostatically with an epoxy powder coat paint.

NOTES:

- * Table heights of 25" (children), 27" (youth), and 32" (wheelchair) are available by request.
- * Color of Metal Paint must be specified at the time of order.
- * Caster Leg options are recommended for Reading/Multipurpose Tables options and not meant to be used for stationary computer workstations.
- * For all tables with casters legs, only 2 legs will have casters, and the other legs will have levelers. This will create a "wheelbarrow" style of table which will ensure ease of mobility.
- * Color of the Caster Option must be specified at the time of order.
- * For the Flip OR Fold Leg option, one T-based leg comes with 2 hidden casters as shown in the image below.

Edge Option:



"DCH"
3/4" Dropped Chamfered Edge

Metal Leg Options:

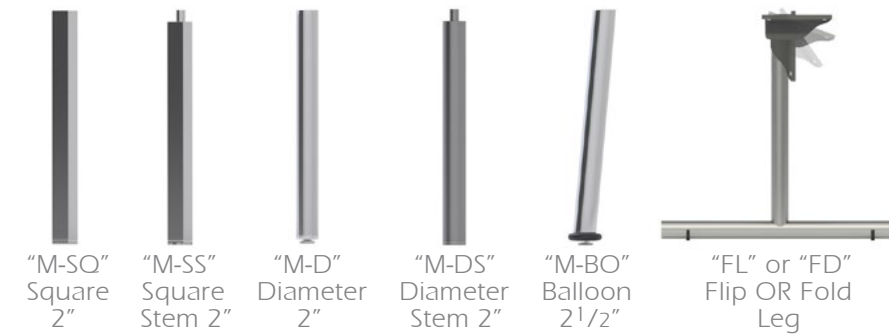

"M-SQ" Square 2"
"M-SS" Square Stem 2"
"M-D" Diameter 2"
"M-DS" Diameter Stem 2"
"M-BO" Balloon 2 1/2"
"FL" or "FD" Flip OR Fold Leg

Wood Leg Options:

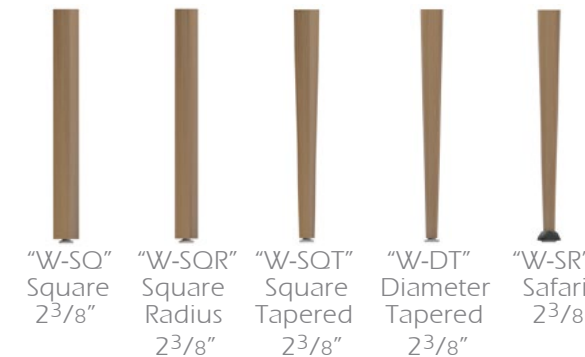

"W-SQ" Square 2 3/8"
"W-SQR" Square Radius 2 3/8"
"W-SQT" Square Tapered 2 3/8"
"W-DT" Diameter Tapered 2 3/8"
"W-SR" Safari 2 3/8"



"MC" Caster Option:
Available on all Metal Legs ONLY, with exception of the Balloon leg and Metal Bases.

MODEL NUMBER
PRODUCT
WIDTH DEPTH HEIGHT
PRICE
DESCRIPTION

*Shown Above:
TB-6024-DCH-M-D



*Rectangle Table Shape

MODEL NUMBER	PRODUCT	WIDTH	DEPTH	HEIGHT
	Rectangle Table, 60" Width, 36" Depth	60"	36"	29"
	DROPPED CHAMFERED Edge;			
	with WOOD Leg Option:	60"	36"	29"
TB-6036-DCH-W-SQ	Square			
TB-6036-DCH-W-SQR	Square Radius			
TB-6036-DCH-W-SQT	Square Tapered			
TB-6036-DCH-W-DT	Diameter Tapered			
TB-6036-DCH-W-SR	Safari			
	with METAL Leg Option:	60"	36"	29"
TB-6036-DCH-M-SQ	Square			
TB-6036-DCH-M-SS	Square & Stem			
TB-6036-DCH-M-D	Diameter			
TB-6036-DCH-M-DS	Diameter & Stem			
TB-6036-DCH-M-BO	Balloon			
TB-6036-DCH-MC-SQ	Square with Casters			
TB-6036-DCH-MC-SS	Square & Stem with Casters			
TB-6036-DCH-MC-D	Diameter with Casters			
TB-6036-DCH-MC-DS	Diameter & Stem with Casters			
TB-6036-DCH-FL	Flip Leg (for Nesting Tables)			
TB-6036-DCH-FD	Folding Leg			

Each Table Top is constructed using a 1 1/8" thick top with a Plastic Laminate top surface.

All Metal legs are coated electrostatically with an epoxy powder coat paint.

NOTES:

- * Table heights of 25" (children), 27" (youth), and 32" (wheelchair) are available by request.
- * Color of Metal Paint must be specified at the time of order.
- * Caster Leg options are recommended for Reading/Multipurpose Tables options and not meant to be used for stationary computer workstations.
- * For all tables with casters legs, only 2 legs will have casters, and the other legs will have levelers. This will create a "wheelbarrow" style of table which will ensure ease of mobility.
- * Color of the Caster Option must be specified at the time of order.
- * For the Flip OR Fold Leg option, one T-based leg comes with 2 hidden casters as shown in the

\$ 1,575
\$ 1,575
\$ 1,763
\$ 1,925
\$ 1,938
\$ 1,494
\$ 2,025
\$ 1,494
\$ 2,025
\$ 1,625
\$ 1,781
\$ 2,306
\$ 1,781
\$ 2,306
\$ 2,563
\$ 2,563

Edge Option:

"DCH"
3/4" Dropped Chamfered Edge

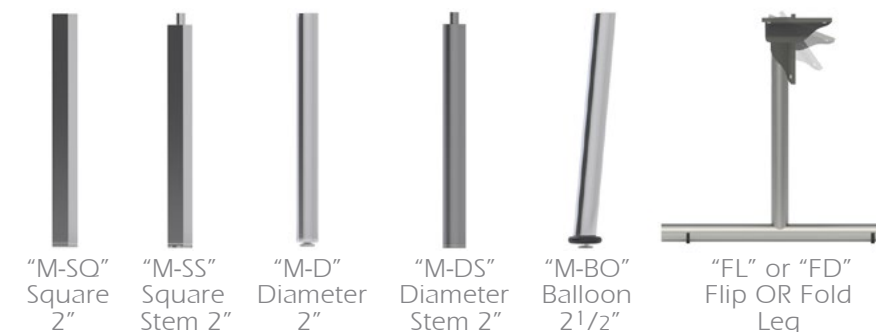
Metal Leg Options:

"M-SQ" Square 2"
"M-SS" Square Stem 2"
"M-D" Diameter 2"
"M-DS" Diameter Stem 2"
"M-BO" Balloon 2 1/2"
"FL" or "FD" Flip OR Fold Leg

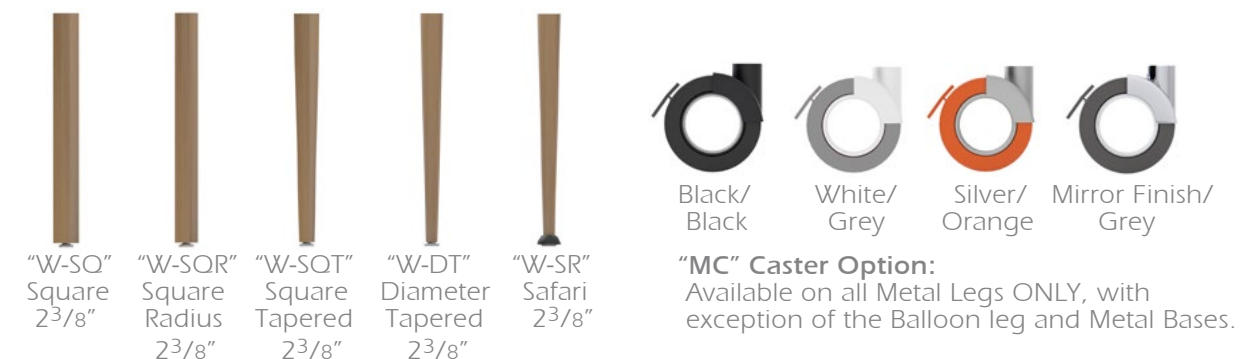
Wood Leg Options:

"W-SQ" Square 2 3/8"
"W-SQR" Square Radius 2 3/8"
"W-SQT" Square Tapered 2 3/8"
"W-DT" Diameter Tapered 2 3/8"
"W-SR" Safari 2 3/8"

Black/Black White/Grey Silver/Orange Mirror Finish/Grey
"MC" Caster Option:
Available on all Metal Legs ONLY, with exception of the Balloon leg and Metal Bases.

MODEL NUMBER
PRODUCT
WIDTH DEPTH HEIGHT
PRICE
DESCRIPTION

*Shown Above:
TB-6024-AL-M-D



*Rectangle Table Shape

MODEL NUMBER	PRODUCT	WIDTH	DEPTH	HEIGHT
	Rectangle Table, 60" Width, 24" Depth	60"	24"	29"
	ALUMINUM Edge;			
	with WOOD Leg Option:	60"	24"	29"
TB-6024-AL-W-SQ	Square			
TB-6024-AL-W-SQR	Square Radius			
TB-6024-AL-W-SQT	Square Tapered			
TB-6024-AL-W-DT	Diameter Tapered			
TB-6024-AL-W-SR	Safari			
	with METAL Leg Option:	60"	24"	29"
TB-6024-AL-M-SQ	Square			
TB-6024-AL-M-SS	Square & Stem			
TB-6024-AL-M-D	Diameter			
TB-6024-AL-M-DS	Diameter & Stem			
TB-6024-AL-M-BO	Balloon			
TB-6024-AL-MC-SQ	Square with Casters			
TB-6024-AL-MC-SS	Square & Stem with Casters			
TB-6024-AL-MC-D	Diameter with Casters			
TB-6024-AL-MC-DS	Diameter & Stem with Casters			
TB-6024-AL-FL	Flip Leg (for Nesting Tables)			
TB-6024-AL-FD	Folding Leg			
	Rectangle Table, 60" Width, 30" Depth	60"	30"	29"
	ALUMINUM Edge;			
	with WOOD Leg Option:	60"	30"	29"
TB-6030-AL-W-SQ	Square			
TB-6030-AL-W-SQR	Square Radius			
TB-6030-AL-W-SQT	Square Tapered			
TB-6030-AL-W-DT	Diameter Tapered			
TB-6030-AL-W-SR	Safari			
	with METAL Leg Option:	60"	30"	29"
TB-6030-AL-M-SQ	Square			
TB-6030-AL-M-SS	Square & Stem			
TB-6030-AL-M-D	Diameter			
TB-6030-AL-M-DS	Diameter & Stem			
TB-6030-AL-M-BO	Balloon			
TB-6030-AL-MC-SQ	Square with Casters			
TB-6030-AL-MC-SS	Square & Stem with Casters			
TB-6030-AL-MC-D	Diameter with Casters			
TB-6030-AL-MC-DS	Diameter & Stem with Casters			
TB-6030-AL-FL	Flip Leg (for Nesting Tables)			
TB-6030-AL-FD	Folding Leg			

\$ 1,188
\$ 1,188
\$ 1,381
\$ 1,544
\$ 1,550

\$ 1,113
\$ 1,638
\$ 1,113
\$ 1,638
\$ 1,238
\$ 1,388
\$ 1,925
\$ 1,388
\$ 1,925
\$ 2,244
\$ 2,244

\$ 1,331
\$ 1,331
\$ 1,525
\$ 1,688
\$ 1,694

\$ 1,250
\$ 1,781
\$ 1,250
\$ 1,781
\$ 1,381
\$ 1,538
\$ 2,063
\$ 1,538
\$ 2,063
\$ 2,319
\$ 2,319

Each Table Top is constructed using a 1 1/8" thick top with a Plastic Laminate top surface.

All Metal legs are coated electrostatically with an epoxy powder coat paint.

NOTES:

- * Table heights of 25" (children), 27" (youth), and 32" (wheelchair) are available by request.
- * Color of Metal Paint must be specified at the time of order.
- * Caster Leg options are recommended for Reading/Multipurpose Tables options and not meant to be used for stationary computer workstations.
- * For all tables with casters legs, only 2 legs will have casters, and the other legs will have levelers. This will create a "wheelbarrow" style of table which will ensure ease of mobility.
- * Color of the Caster Option must be specified at the time of order.
- * For the Flip OR Fold Leg option, one T-based leg comes with 2 hidden casters as shown in the image below.

Edge Option:

"AL"

3mm Aluminum Edge *All table corners will be given a 6-inch radius for this edge option.

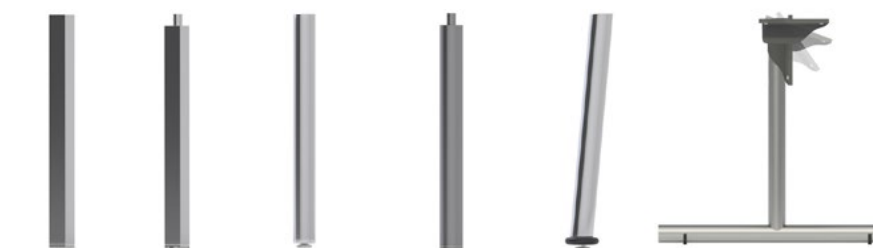
Metal Leg Options:

"M-SQ" Square 2"
"M-SS" Square Stem 2"
"M-D" Diameter 2"
"M-DS" Diameter Stem 2"
"M-BO" Balloon 2 1/2"
"FL" or "FD" Flip OR Fold Leg

Wood Leg Options:

"W-SQ" Square 2 3/8"
"W-SQR" Square Radius 2 3/8"
"W-SQT" Square Tapered 2 3/8"
"W-DT" Diameter Tapered 2 3/8"
"W-SR" Safari 2 3/8"

"MC" Caster Option:
Available on all Metal Legs ONLY, with exception of the Balloon leg and Metal Bases.

MODEL NUMBER

PRODUCT

WIDTH DEPTH HEIGHT

PRICE

DESCRIPTION



*Shown Above:
TB-6024-AL-M-D



*Rectangle Table Shape

MODEL NUMBER	PRODUCT	WIDTH	DEPTH	HEIGHT	PRICE
	Rectangle Table, 60" Width, 36" Depth	60"	36"	29"	
	ALUMINUM Edge;				
	with WOOD Leg Option:	60"	36"	29"	
TB-6036-AL-W-SQ	Square				\$ 1,388
TB-6036-AL-W-SQR	Square Radius				\$ 1,388
TB-6036-AL-W-SQT	Square Tapered				\$ 1,575
TB-6036-AL-W-DT	Diameter Tapered				\$ 1,738
TB-6036-AL-W-SR	Safari				\$ 1,744
	with METAL Leg Option:	60"	36"	29"	
TB-6036-AL-M-SQ	Square				\$ 1,306
TB-6036-AL-M-SS	Square & Stem				\$ 1,838
TB-6036-AL-M-D	Diameter				\$ 1,306
TB-6036-AL-M-DS	Diameter & Stem				\$ 1,838
TB-6036-AL-M-BO	Balloon				\$ 1,431
TB-6036-AL-MC-SQ	Square with Casters				\$ 1,588
TB-6036-AL-MC-SS	Square & Stem with Casters				\$ 2,119
TB-6036-AL-MC-D	Diameter with Casters				\$ 1,588
TB-6036-AL-MC-DS	Diameter & Stem with Casters				\$ 2,119
TB-6036-AL-FL	Flip Leg (for Nesting Tables)				\$ 2,375
TB-6036-AL-FD	Folding Leg				\$ 2,375

Each Table Top is constructed using a 1 1/8" thick top with a Plastic Laminate top surface.

All Metal legs are coated electrostatically with an epoxy powder coat paint.

NOTES:

- * Table heights of 25" (children), 27" (youth), and 32" (wheelchair) are available by request.
- * Color of Metal Paint must be specified at the time of order.
- * Caster Leg options are recommended for Reading/Multipurpose Tables options and not meant to be used for stationary computer workstations.
- * For all tables with casters legs, only 2 legs will have casters, and the other legs will have levelers. This will create a "wheelbarrow" style of table which will ensure ease of mobility.
- * Color of the Caster Option must be specified at the time of order.
- * For the Flip OR Fold Leg option, one T-based leg comes with 2 hidden casters as shown in the image below.

Edge Option:



"AL"

3mm Aluminum Edge *All table corners will be given a 6-inch radius for this edge option.

Metal Leg Options:

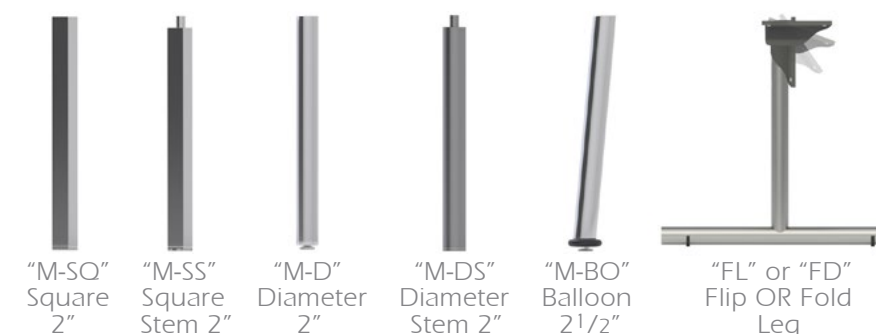

"M-SQ" Square 2"
"M-SS" Square Stem 2"
"M-D" Diameter 2"
"M-DS" Diameter Stem 2"
"M-BO" Balloon 2 1/2"
"FL" or "FD" Flip OR Fold Leg

Wood Leg Options:



"W-SQ" Square 2 3/8"
"W-SQR" Square Radius 2 3/8"
"W-SQT" Square Tapered 2 3/8"
"W-DT" Diameter Tapered 2 3/8"
"W-SR" Safari 2 3/8"

Black/Black White/Grey Silver/Orange Mirror Finish/Grey

"MC" Caster Option:
Available on all Metal Legs ONLY, with exception of the Balloon leg and Metal Bases.

MODEL NUMBER
PRODUCT
WIDTH DEPTH HEIGHT
PRICE
DESCRIPTION

*Shown Above:
TB-7224-AC-M-D



*Rectangle Table Shape

MODEL NUMBER	PRODUCT	WIDTH	DEPTH	HEIGHT
	Rectangle Table, 72" Width, 24" Depth	72"	24"	29"
	ACRYLIC Edge;			
	with WOOD Leg Option:	72"	24"	29"
TB-7224-AC-W-SQ	Square			
TB-7224-AC-W-SQR	Square Radius			
TB-7224-AC-W-SQT	Square Tapered			
TB-7224-AC-W-DT	Diameter Tapered			
TB-7224-AC-W-SR	Safari			
	with METAL Leg Option:	72"	24"	29"
TB-7224-AC-M-SQ	Square			
TB-7224-AC-M-SS	Square & Stem			
TB-7224-AC-M-D	Diameter			
TB-7224-AC-M-DS	Diameter & Stem			
TB-7224-AC-M-BO	Balloon			
TB-7224-AC-MC-SQ	Square with Casters			
TB-7224-AC-MC-SS	Square & Stem with Casters			
TB-7224-AC-MC-D	Diameter with Casters			
TB-7224-AC-MC-DS	Diameter & Stem with Casters			
TB-7224-AC-FL	Flip Leg (for Nesting Tables)			
TB-7224-AC-FD	Folding Leg			
	Rectangle Table, 72" Width, 30" Depth	72"	30"	29"
	ACRYLIC Edge;			
	with WOOD Leg Option:	72"	30"	29"
TB-7230-AC-W-SQ	Square			
TB-7230-AC-W-SQR	Square Radius			
TB-7230-AC-W-SQT	Square Tapered			
TB-7230-AC-W-DT	Diameter Tapered			
TB-7230-AC-W-SR	Safari			
	with METAL Leg Option:	72"	30"	29"
TB-7230-AC-M-SQ	Square			
TB-7230-AC-M-SS	Square & Stem			
TB-7230-AC-M-D	Diameter			
TB-7230-AC-M-DS	Diameter & Stem			
TB-7230-AC-M-BO	Balloon			
TB-7230-AC-MC-SQ	Square with Casters			
TB-7230-AC-MC-SS	Square & Stem with Casters			
TB-7230-AC-MC-D	Diameter with Casters			
TB-7230-AC-MC-DS	Diameter & Stem with Casters			
TB-7230-AC-FL	Flip Leg (for Nesting Tables)			
TB-7230-AC-FD	Folding Leg			

\$ 1,225
\$ 1,225
\$ 1,413
\$ 1,575
\$ 1,581

\$ 1,144
\$ 1,669
\$ 1,144
\$ 1,669
\$ 1,269
\$ 1,425
\$ 1,956
\$ 1,425
\$ 1,956
\$ 2,194
\$ 2,194

Each Table Top is constructed using a 1" thick top with a Plastic Laminate top surface.

All Metal legs are coated electrostatically with an epoxy powder coat paint.

NOTES:

- * Table heights of 25" (children), 27" (youth), and 32" (wheelchair) are available by request.
- * Color of Metal Paint must be specified at the time of order.
- * Caster Leg options are recommended for Reading/Multipurpose Tables options and not meant to be used for stationary computer workstations.
- * For all tables with casters legs, only 2 legs will have casters, and the other legs will have levelers. This will create a "wheelbarrow" style of table which will ensure ease of mobility.
- * Color of the Caster Option must be specified at the time of order.
- * For the Flip OR Fold Leg option, one T-based leg comes with 2 hidden casters as shown in the image below.

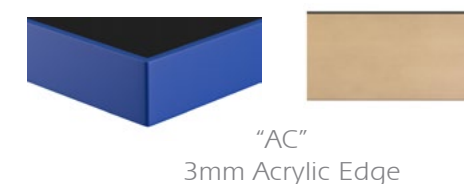
Edge Option:

"AC"
3mm Acrylic Edge

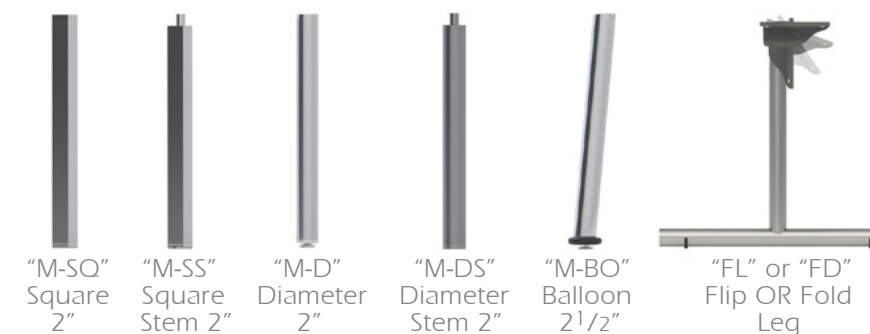
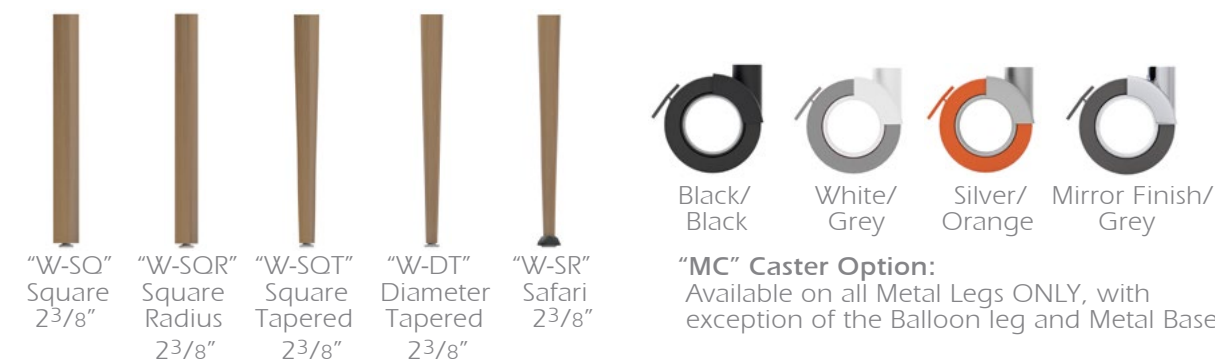
Metal Leg Options:

Wood Leg Options:

"MC" Caster Option:
Available on all Metal Legs ONLY, with exception of the Balloon leg and Metal Bases.

MODEL NUMBER

PRODUCT

WIDTH DEPTH HEIGHT

PRICE

DESCRIPTION



*Shown Above:
TB-7224-AC-M-D



*Rectangle Table Shape

MODEL NUMBER	PRODUCT	WIDTH	DEPTH	HEIGHT
	Rectangle Table, 72" Width, 36" Depth	72"	36"	29"
	ACRYLIC Edge;			
	with WOOD Leg Option:	72"	36"	29"
TB-7236-AC-W-SQ	Square			
TB-7236-AC-W-SQR	Square Radius			
TB-7236-AC-W-SQT	Square Tapered			
TB-7236-AC-W-DT	Diameter Tapered			
TB-7236-AC-W-SR	Safari			
	with METAL Leg Option:	72"	36"	29"
TB-7236-AC-M-SQ	Square			
TB-7236-AC-M-SS	Square & Stem			
TB-7236-AC-M-D	Diameter			
TB-7236-AC-M-DS	Diameter & Stem			
TB-7236-AC-M-BO	Balloon			
TB-7236-AC-MC-SQ	Square with Casters			
TB-7236-AC-MC-SS	Square & Stem with Casters			
TB-7236-AC-MC-D	Diameter with Casters			
TB-7236-AC-MC-DS	Diameter & Stem with Casters			
TB-7236-AC-FL	Flip Leg (for Nesting Tables)			
TB-7236-AC-FD	Folding Leg			
	Rectangle Table, 72" Width, 42" Depth	72"	42"	29"
	ACRYLIC Edge;			
	with WOOD Leg Option:	72"	42"	29"
TB-7242-AC-W-SQ	Square			
TB-7242-AC-W-SQR	Square Radius			
TB-7242-AC-W-SQT	Square Tapered			
TB-7242-AC-W-DT	Diameter Tapered			
TB-7242-AC-W-SR	Safari			
	with METAL Leg Option:	72"	42"	29"
TB-7242-AC-M-SQ	Square			
TB-7242-AC-M-SS	Square & Stem			
TB-7242-AC-M-D	Diameter			
TB-7242-AC-M-DS	Diameter & Stem			
TB-7242-AC-M-BO	Balloon			
TB-7242-AC-MC-SQ	Square with Casters			
TB-7242-AC-MC-SS	Square & Stem with Casters			
TB-7242-AC-MC-D	Diameter with Casters			
TB-7242-AC-MC-DS	Diameter & Stem with Casters			
TB-7242-AC-FL	Flip Leg (for Nesting Tables)			
TB-7242-AC-FD	Folding Leg			

Each Table Top is constructed using a 1" thick top with a Plastic Laminate top surface.

All Metal legs are coated electrostatically with an epoxy powder coat paint.

NOTES:

- * Table heights of 25" (children), 27" (youth), and 32" (wheelchair) are available by request.
- * Color of Metal Paint must be specified at the time of order.
- * Caster Leg options are recommended for Reading/Multipurpose Tables options and not meant to be used for stationary computer workstations.
- * For all tables with casters legs, only 2 legs will have casters, and the other legs will have levelers. This will create a "wheelbarrow" style of table which will ensure ease of mobility.
- * Color of the Caster Option must be specified at the time of order.
- * For the Flip OR Fold Leg option, one T-based leg comes with 2 hidden casters as shown in the image below.

\$ 1,331
\$ 1,331
\$ 1,519
\$ 1,681
\$ 1,688

\$ 1,250
\$ 1,775
\$ 1,250
\$ 1,775
\$ 1,375
\$ 1,525
\$ 2,063
\$ 1,525
\$ 2,063
\$ 2,319
\$ 2,319

Edge Option:

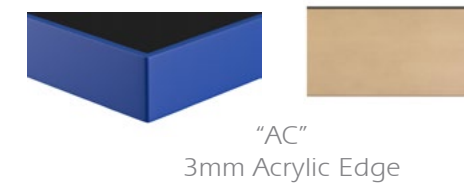

Metal Leg Options:

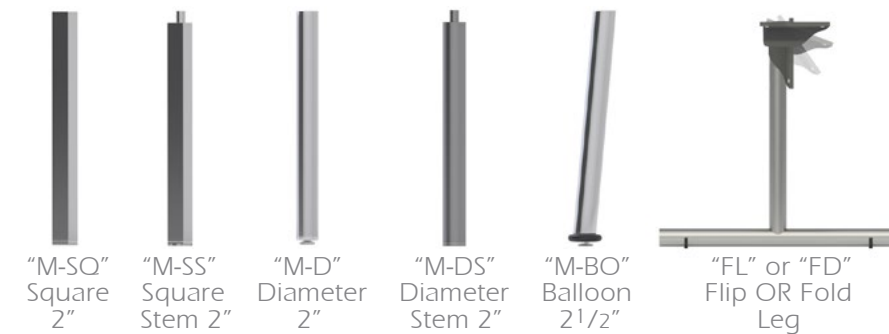

Wood Leg Options:

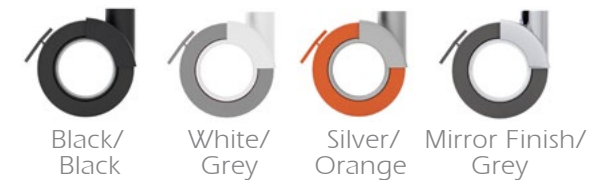
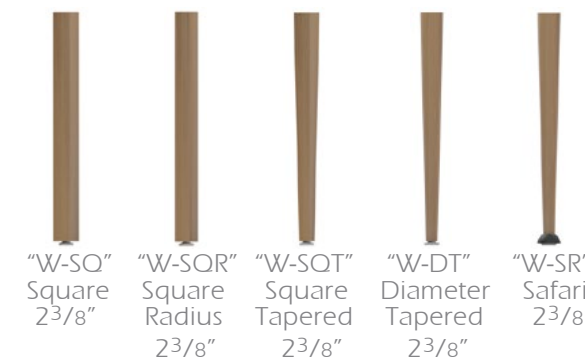

"MC" Caster Option:
Available on all Metal Legs ONLY, with exception of the Balloon leg and Metal Bases.

MODEL NUMBER
PRODUCT
WIDTH DEPTH HEIGHT
PRICE
DESCRIPTION

*Shown Above:
TB-7224-SQ-M-D



*Rectangle Table Shape

MODEL NUMBER	PRODUCT	WIDTH	DEPTH	HEIGHT
	Rectangle Table, 72" Width, 24" Depth	72"	24"	29"
	SQUARE Edge;			
	with WOOD Leg Option:	72"	24"	29"
TB-7224-SQ-W-SQ	Square			
TB-7224-SQ-W-SQR	Square Radius			
TB-7224-SQ-W-SQT	Square Tapered			
TB-7224-SQ-W-DT	Diameter Tapered			
TB-7224-SQ-W-SR	Safari			
	with METAL Leg Option:	72"	24"	29"
TB-7224-SQ-M-SQ	Square			
TB-7224-SQ-M-SS	Square & Stem			
TB-7224-SQ-M-D	Diameter			
TB-7224-SQ-M-DS	Diameter & Stem			
TB-7224-SQ-M-BO	Balloon			
TB-7224-SQ-MC-SQ	Square with Casters			
TB-7224-SQ-MC-SS	Square & Stem with Casters			
TB-7224-SQ-MC-D	Diameter with Casters			
TB-7224-SQ-MC-DS	Diameter & Stem with Casters			
TB-7224-SQ-FL	Flip Leg (for Nesting Tables)			
TB-7224-SQ-FD	Folding Leg			
	Rectangle Table, 72" Width, 30" Depth	72"	30"	29"
	SQUARE Edge;			
	with WOOD Leg Option:	72"	30"	29"
TB-7230-SQ-W-SQ	Square			
TB-7230-SQ-W-SQR	Square Radius			
TB-7230-SQ-W-SQT	Square Tapered			
TB-7230-SQ-W-DT	Diameter Tapered			
TB-7230-SQ-W-SR	Safari			
	with METAL Leg Option:	72"	30"	29"
TB-7230-SQ-M-SQ	Square			
TB-7230-SQ-M-SS	Square & Stem			
TB-7230-SQ-M-D	Diameter			
TB-7230-SQ-M-DS	Diameter & Stem			
TB-7230-SQ-M-BO	Balloon			
TB-7230-SQ-MC-SQ	Square with Casters			
TB-7230-SQ-MC-SS	Square & Stem with Casters			
TB-7230-SQ-MC-D	Diameter with Casters			
TB-7230-SQ-MC-DS	Diameter & Stem with Casters			
TB-7230-SQ-FL	Flip Leg (for Nesting Tables)			
TB-7230-SQ-FD	Folding Leg			

\$ 1,413
\$ 1,413
\$ 1,606
\$ 1,763
\$ 1,769

\$ 1,331
\$ 1,863
\$ 1,331
\$ 1,863
\$ 1,463
\$ 1,613
\$ 2,144
\$ 1,613
\$ 2,144
\$ 2,381
\$ 2,381

Each Table Top is constructed using a 1 1/8" thick top with a Plastic Laminate top surface.

All Metal legs are coated electrostatically with an epoxy powder coat paint.

NOTES:

- * Table heights of 25" (children), 27" (youth), and 32" (wheelchair) are available by request.
- * Color of Metal Paint must be specified at the time of order.
- * Caster Leg options are recommended for Reading/Multipurpose Tables options and not meant to be used for stationary computer workstations.
- * For all tables with casters legs, only 2 legs will have casters, and the other legs will have levelers. This will create a "wheelbarrow" style of table which will ensure ease of mobility.
- * Color of the Caster Option must be specified at the time of order.
- * For the Flip OR Fold Leg option, one T-based leg comes with 2 hidden casters as shown in the image below.

Edge Option:

"SQ"
1/4" Square Edge

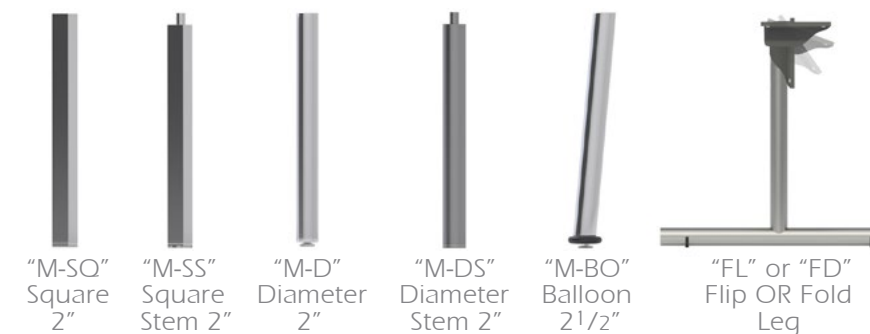
Metal Leg Options:

"M-SQ" Square 2"
"M-SS" Square Stem 2"
"M-D" Diameter 2"
"M-DS" Diameter Stem 2"
"M-BO" Balloon 2 1/2"
"FL" or "FD" Flip OR Fold Leg

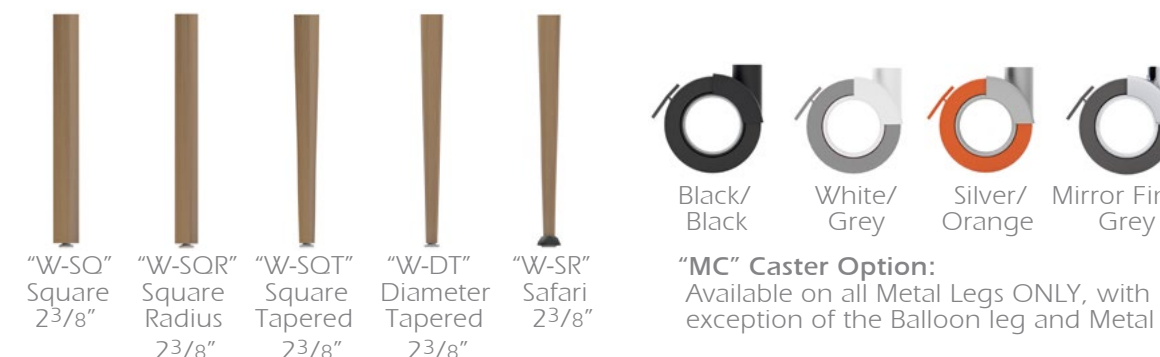
Wood Leg Options:

"W-SQ" Square 2 3/8"
"W-SQR" Square Radius 2 3/8"
"W-SQT" Square Tapered 2 3/8"
"W-DT" Diameter Tapered 2 3/8"
"W-SR" Safari 2 3/8"

"MC" Caster Option:
Available on all Metal Legs ONLY, with exception of the Balloon leg and Metal Bases.

MODEL NUMBER

PRODUCT

WIDTH DEPTH HEIGHT

PRICE

DESCRIPTION



*Shown Above:
TB-7224-SQ-M-D



*Rectangle Table Shape

MODEL NUMBER	PRODUCT	WIDTH	DEPTH	HEIGHT
	Rectangle Table, 72" Width, 36" Depth	72"	36"	29"
	SQUARE Edge;			
	with WOOD Leg Option:	72"	36"	29"
TB-7236-SQ-W-SQ	Square			
TB-7236-SQ-W-SQR	Square Radius			
TB-7236-SQ-W-SQT	Square Tapered			
TB-7236-SQ-W-DT	Diameter Tapered			
TB-7236-SQ-W-SR	Safari			
	with METAL Leg Option:	72"	36"	29"
TB-7236-SQ-M-SQ	Square			
TB-7236-SQ-M-SS	Square & Stem			
TB-7236-SQ-M-D	Diameter			
TB-7236-SQ-M-DS	Diameter & Stem			
TB-7236-SQ-M-BO	Balloon			
TB-7236-SQ-MC-SQ	Square with Casters			
TB-7236-SQ-MC-SS	Square & Stem with Casters			
TB-7236-SQ-MC-D	Diameter with Casters			
TB-7236-SQ-MC-DS	Diameter & Stem with Casters			
TB-7236-SQ-FL	Flip Leg (for Nesting Tables)			
TB-7236-SQ-FD	Folding Leg			
	Rectangle Table, 72" Width, 42" Depth	72"	42"	29"
	SQUARE Edge;			
	with WOOD Leg Option:	72"	42"	29"
TB-7242-SQ-W-SQ	Square			
TB-7242-SQ-W-SQR	Square Radius			
TB-7242-SQ-W-SQT	Square Tapered			
TB-7242-SQ-W-DT	Diameter Tapered			
TB-7242-SQ-W-SR	Safari			
	with METAL Leg Option:	72"	42"	29"
TB-7242-SQ-M-SQ	Square			
TB-7242-SQ-M-SS	Square & Stem			
TB-7242-SQ-M-D	Diameter			
TB-7242-SQ-M-DS	Diameter & Stem			
TB-7242-SQ-M-BO	Balloon			
TB-7242-SQ-MC-SQ	Square with Casters			
TB-7242-SQ-MC-SS	Square & Stem with Casters			
TB-7242-SQ-MC-D	Diameter with Casters			
TB-7242-SQ-MC-DS	Diameter & Stem with Casters			
TB-7242-SQ-FL	Flip Leg (for Nesting Tables)			
TB-7242-SQ-FD	Folding Leg			

Each Table Top is constructed using a 1 1/8" thick top with a Plastic Laminate top surface.

All Metal legs are coated electrostatically with an epoxy powder coat paint.

NOTES:

- * Table heights of 25" (children), 27" (youth), and 32" (wheelchair) are available by request.
- * Color of Metal Paint must be specified at the time of order.
- * Caster Leg options are recommended for Reading/Multipurpose Tables options and not meant to be used for stationary computer workstations.
- * For all tables with casters legs, only 2 legs will have casters, and the other legs will have levelers. This will create a "wheelbarrow" style of table which will ensure ease of mobility.
- * Color of the Caster Option must be specified at the time of order.
- * For the Flip OR Fold Leg option, one T-based leg comes with 2 hidden casters as shown in the image below.

\$ 1,544
\$ 1,544
\$ 1,731
\$ 1,894
\$ 1,900

\$ 1,463
\$ 1,988
\$ 1,463
\$ 1,988
\$ 1,588
\$ 1,744
\$ 2,275
\$ 1,744
\$ 2,275
\$ 2,538
\$ 2,538

Edge Option:



"SQ"
1/4" Square Edge

Metal Leg Options:

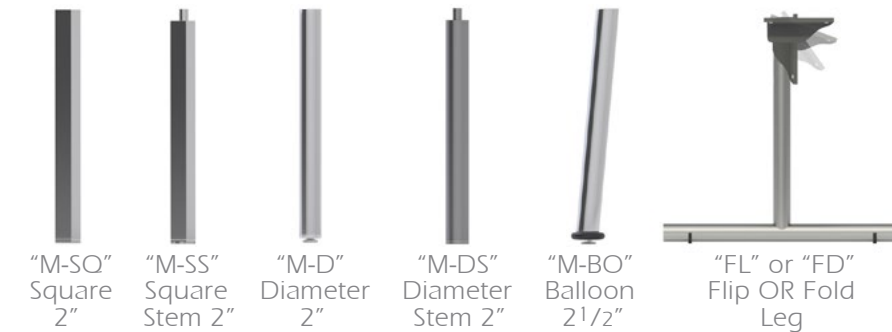

"M-SQ" Square 2"
"M-SS" Square Stem 2"
"M-D" Diameter 2"
"M-DS" Diameter Stem 2"
"M-BO" Balloon 2 1/2"
"FL" or "FD" Flip OR Fold Leg

Wood Leg Options:

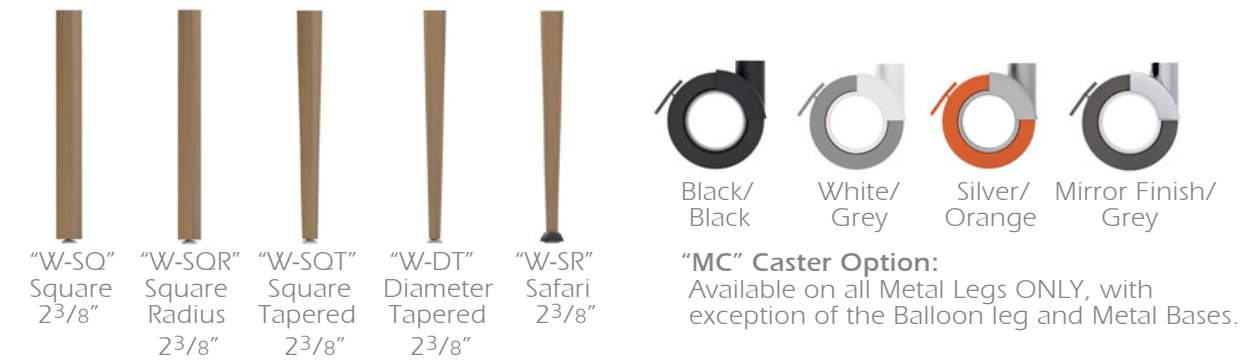

"W-SQ" Square 2 3/8"
"W-SQR" Square Radius 2 3/8"
"W-SQT" Square Tapered 2 3/8"
"W-DT" Diameter Tapered 2 3/8"
"W-SR" Safari 2 3/8"

Black/Black White/Grey Silver/Orange Mirror Finish/Grey

"MC" Caster Option:
Available on all Metal Legs ONLY, with exception of the Balloon leg and Metal Bases.

MODEL NUMBER **PRODUCT** **WIDTH** **DEPTH** **HEIGHT**



*Shown Above:
TB-7224-DSQ-M-D



*Rectangle Table Shape

	Rectangle Table, 72" Width, 24" Depth	72"	24"	29"
	DROPPED SQUARE Edge;			
	with WOOD Leg Option:	72"	24"	29"
TB-7224-DSQ-W-SQ	Square			
TB-7224-DSQ-W-SQR	Square Radius			
TB-7224-DSQ-W-SQT	Square Tapered			
TB-7224-DSQ-W-DT	Diameter Tapered			
TB-7224-DSQ-W-SR	Safari			
	with METAL Leg Option:	72"	24"	29"
TB-7224-DSQ-M-SQ	Square			
TB-7224-DSQ-M-SS	Square & Stem			
TB-7224-DSQ-M-D	Diameter			
TB-7224-DSQ-M-DS	Diameter & Stem			
TB-7224-DSQ-M-BO	Balloon			
TB-7224-DSQ-MC-SQ	Square with Casters			
TB-7224-DSQ-MC-SS	Square & Stem with Casters			
TB-7224-DSQ-MC-D	Diameter with Casters			
TB-7224-DSQ-MC-DS	Diameter & Stem with Casters			
TB-7224-DSQ-FL	Flip Leg (for Nesting Tables)			
TB-7224-DSQ-FD	Folding Leg			
	Rectangle Table, 72" Width, 30" Depth	72"	30"	29"
	DROPPED SQUARE Edge;			
	with WOOD Leg Option:	72"	30"	29"
TB-7230-DSQ-W-SQ	Square			
TB-7230-DSQ-W-SQR	Square Radius			
TB-7230-DSQ-W-SQT	Square Tapered			
TB-7230-DSQ-W-DT	Diameter Tapered			
TB-7230-DSQ-W-SR	Safari			
	with METAL Leg Option:	72"	30"	29"
TB-7230-DSQ-M-SQ	Square			
TB-7230-DSQ-M-SS	Square & Stem			
TB-7230-DSQ-M-D	Diameter			
TB-7230-DSQ-M-DS	Diameter & Stem			
TB-7230-DSQ-M-BO	Balloon			
TB-7230-DSQ-MC-SQ	Square with Casters			
TB-7230-DSQ-MC-SS	Square & Stem with Casters			
TB-7230-DSQ-MC-D	Diameter with Casters			
TB-7230-DSQ-MC-DS	Diameter & Stem with Casters			
TB-7230-DSQ-FL	Flip Leg (for Nesting Tables)			
TB-7230-DSQ-FD	Folding Leg			

PRICE **DESCRIPTION**

	Each Table Top is constructed using a 1 1/8" thick top with a Plastic Laminate top surface.
	All Metal legs are coated electrostatically with an epoxy powder coat paint.
	NOTES:
	* Table heights of 25" (children), 27" (youth), and 32" (wheelchair) are available by request.
	* Color of Metal Paint must be specified at the time of order.
	* Caster Leg options are recommended for Reading/Multipurpose Tables options and not meant to be used for stationary computer workstations.
	* For all tables with casters legs, only 2 legs will have casters, and the other legs will have levelers. This will create a "wheelbarrow" style of table which will ensure ease of mobility.
	* Color of the Caster Option must be specified at the time of order.
	* For the Flip OR Fold Leg option, one T-based leg comes with 2 hidden casters as shown in the image below.
	Edge Option:
	"DSQ" 3/4" Dropped Square Edge
	Metal Leg Options:
	"M-SQ" Square 2" "M-SS" Square Stem 2" "M-D" Diameter 2" "M-DS" Diameter Stem 2" "M-BO" Balloon 2 1/2" "FL" or "FD" Flip OR Fold Leg
	Wood Leg Options:
	"W-SQ" Square 2 3/8" "W-SQR" Square Radius 2 3/8" "W-SQT" Square Tapered 2 3/8" "W-DT" Diameter Tapered 2 3/8" "W-SR" Safari 2 3/8" "MC" Caster Option: Available on all Metal Legs ONLY, with exception of the Balloon leg and Metal Bases.
\$ 1,513	
\$ 1,513	
\$ 1,706	
\$ 1,863	
\$ 1,869	
\$ 1,431	
\$ 1,963	
\$ 1,431	
\$ 1,963	
\$ 1,819	
\$ 1,713	
\$ 2,244	
\$ 1,713	
\$ 2,244	
\$ 2,481	
\$ 2,481	
\$ 1,588	
\$ 1,588	
\$ 1,775	
\$ 1,938	
\$ 1,944	
\$ 1,506	
\$ 2,031	
\$ 1,506	
\$ 2,031	
\$ 1,631	
\$ 1,781	
\$ 2,319	
\$ 1,781	
\$ 2,319	
\$ 2,569	
\$ 2,569	

MODEL NUMBER **PRODUCT** **WIDTH** **DEPTH** **HEIGHT**



*Shown Above:
TB-7224-DSQ-M-D



*Rectangle Table Shape

	Rectangle Table, 72" Width, 36" Depth	72"	36"	29"
	DROPPED SQUARE Edge;			
	with WOOD Leg Option:	72"	36"	29"
TB-7236-DSQ-W-SQ	Square			
TB-7236-DSQ-W-SQR	Square Radius			
TB-7236-DSQ-W-SQT	Square Tapered			
TB-7236-DSQ-W-DT	Diameter Tapered			
TB-7236-DSQ-W-SR	Safari			
	with METAL Leg Option:	72"	36"	29"
TB-7236-DSQ-M-SQ	Square			
TB-7236-DSQ-M-SS	Square & Stem			
TB-7236-DSQ-M-D	Diameter			
TB-7236-DSQ-M-DS	Diameter & Stem			
TB-7236-DSQ-M-BO	Balloon			
TB-7236-DSQ-MC-SQ	Square with Casters			
TB-7236-DSQ-MC-SS	Square & Stem with Casters			
TB-7236-DSQ-MC-D	Diameter with Casters			
TB-7236-DSQ-MC-DS	Diameter & Stem with Casters			
TB-7236-DSQ-FL	Flip Leg (for Nesting Tables)			
TB-7236-DSQ-FD	Folding Leg			
	Rectangle Table, 72" Width, 42" Depth	72"	42"	29"
	DROPPED SQUARE Edge;			
	with WOOD Leg Option:	72"	42"	29"
TB-7242-DSQ-W-SQ	Square			
TB-7242-DSQ-W-SQR	Square Radius			
TB-7242-DSQ-W-SQT	Square Tapered			
TB-7242-DSQ-W-DT	Diameter Tapered			
TB-7242-DSQ-W-SR	Safari			
	with METAL Leg Option:	72"	42"	29"
TB-7242-DSQ-M-SQ	Square			
TB-7242-DSQ-M-SS	Square & Stem			
TB-7242-DSQ-M-D	Diameter			
TB-7242-DSQ-M-DS	Diameter & Stem			
TB-7242-DSQ-M-BO	Balloon			
TB-7242-DSQ-MC-SQ	Square with Casters			
TB-7242-DSQ-MC-SS	Square & Stem with Casters			
TB-7242-DSQ-MC-D	Diameter with Casters			
TB-7242-DSQ-MC-DS	Diameter & Stem with Casters			
TB-7242-DSQ-FL	Flip Leg (for Nesting Tables)			
TB-7242-DSQ-FD	Folding Leg			

PRICE **DESCRIPTION**

	Each Table Top is constructed using a 1 1/8" thick top with a Plastic Laminate top surface.
	All Metal legs are coated electrostatically with an epoxy powder coat paint.
	NOTES:
	* Table heights of 25" (children), 27" (youth), and 32" (wheelchair) are available by request.
	* Color of Metal Paint must be specified at the time of order.
	* Caster Leg options are recommended for Reading/Multipurpose Tables options and not meant to be used for stationary computer workstations.
	* For all tables with casters legs, only 2 legs will have casters, and the other legs will have levelers. This will create a "wheelbarrow" style of table which will ensure ease of mobility.
	* Color of the Caster Option must be specified at the time of order.
	* For the Flip OR Fold Leg option, one T-based leg comes with 2 hidden casters as shown in the image below.
	Edge Option:
	"DSQ" 3/4" Dropped Square Edge
	Metal Leg Options:
	"M-SQ" Square 2" "M-SS" Square Stem 2" "M-D" Diameter 2" "M-DS" Diameter Stem 2" "M-BO" Balloon 2 1/2" "FL" or "FD" Flip OR Fold Leg
	Wood Leg Options:
	"W-SQ" Square 2 3/8" "W-SQR" Square Radius 2 3/8" "W-SQT" Square Tapered 2 3/8" "W-DT" Diameter Tapered 2 3/8" "W-SR" Safari 2 3/8" "MC" Caster Option: Available on all Metal Legs ONLY, with exception of the Balloon leg and Metal Bases.
\$ 1,656	
\$ 1,656	
\$ 1,844	
\$ 2,006	
\$ 2,013	
\$ 1,575	
\$ 2,100	
\$ 1,575	
\$ 2,100	
\$ 1,706	
\$ 1,856	
\$ 2,388	
\$ 1,856	
\$ 2,388	
\$ 2,650	
\$ 2,650	
\$ 1,725	
\$ 1,725	
\$ 1,919	
\$ 2,081	
\$ 2,088	
\$ 1,644	
\$ 2,175	
\$ 1,644	
\$ 2,175	
\$ 1,775	
\$ 1,925	
\$ 2,456	
\$ 1,925	
\$ 2,456	
\$ 2,756	
\$ 2,756	

MODEL NUMBER

PRODUCT

WIDTH DEPTH HEIGHT

PRICE

DESCRIPTION



*Shown Above:
TB-7224-DBN-M-D



*Rectangle Table Shape

MODEL NUMBER	PRODUCT	WIDTH	DEPTH	HEIGHT	PRICE
	Rectangle Table, 72" Width, 24" Depth	72"	24"	29"	
	DROPPED BULLNOSE Edge;				
	with WOOD Leg Option:	72"	24"	29"	
TB-7224-DBN-W-SQ	Square				\$ 1,525
TB-7224-DBN-W-SQR	Square Radius				\$ 1,525
TB-7224-DBN-W-SQT	Square Tapered				\$ 1,719
TB-7224-DBN-W-DT	Diameter Tapered				\$ 1,881
TB-7224-DBN-W-SR	Safari				\$ 1,888
	with METAL Leg Option:	72"	24"	29"	
TB-7224-DBN-M-SQ	Square				\$ 1,450
TB-7224-DBN-M-SS	Square & Stem				\$ 1,975
TB-7224-DBN-M-D	Diameter				\$ 1,450
TB-7224-DBN-M-DS	Diameter & Stem				\$ 1,975
TB-7224-DBN-M-BO	Balloon				\$ 1,575
TB-7224-DBN-MC-SQ	Square with Casters				\$ 1,725
TB-7224-DBN-MC-SS	Square & Stem with Casters				\$ 2,256
TB-7224-DBN-MC-D	Diameter with Casters				\$ 1,725
TB-7224-DBN-MC-DS	Diameter & Stem with Casters				\$ 2,256
TB-7224-DBN-FL	Flip Leg (for Nesting Tables)				\$ 2,494
TB-7224-DBN-FD	Folding Leg				\$ 2,494
	Rectangle Table, 72" Width, 30" Depth	72"	30"	29"	
	DROPPED BULLNOSE Edge;				
	with WOOD Leg Option:	72"	30"	29"	
TB-7230-DBN-W-SQ	Square				\$ 1,600
TB-7230-DBN-W-SQR	Square Radius				\$ 1,600
TB-7230-DBN-W-SQT	Square Tapered				\$ 1,788
TB-7230-DBN-W-DT	Diameter Tapered				\$ 1,950
TB-7230-DBN-W-SR	Safari				\$ 1,956
	with METAL Leg Option:	72"	30"	29"	
TB-7230-DBN-M-SQ	Square				\$ 1,519
TB-7230-DBN-M-SS	Square & Stem				\$ 2,044
TB-7230-DBN-M-D	Diameter				\$ 1,519
TB-7230-DBN-M-DS	Diameter & Stem				\$ 2,044
TB-7230-DBN-M-BO	Balloon				\$ 1,644
TB-7230-DBN-MC-SQ	Square with Casters				\$ 1,800
TB-7230-DBN-MC-SS	Square & Stem with Casters				\$ 2,331
TB-7230-DBN-MC-D	Diameter with Casters				\$ 1,800
TB-7230-DBN-MC-DS	Diameter & Stem with Casters				\$ 2,331
TB-7230-DBN-FL	Flip Leg (for Nesting Tables)				\$ 2,581
TB-7230-DBN-FD	Folding Leg				\$ 2,581

Each Table Top is constructed using a 1 1/8" thick top with a Plastic Laminate top surface.

All Metal legs are coated electrostatically with an epoxy powder coat paint.

NOTES:

- * Table heights of 25" (children), 27" (youth), and 32" (wheelchair) are available by request.
- * Color of Metal Paint must be specified at the time of order.
- * Caster Leg options are recommended for Reading/Multipurpose Tables options and not meant to be used for stationary computer workstations.
- * For all tables with casters legs, only 2 legs will have casters, and the other legs will have levelers. This will create a "wheelbarrow" style of table which will ensure ease of mobility.
- * Color of the Caster Option must be specified at the time of order.
- * For the Flip OR Fold Leg option, one T-based leg comes with 2 hidden casters as shown in the image below.

Edge Option:



"DBN"
3/4" Dropped Bullnoses Edge

Metal Leg Options:

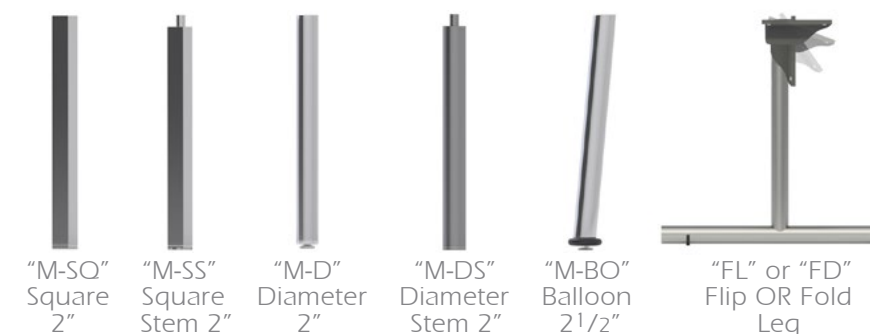

"M-SQ" Square 2"
"M-SS" Square Stem 2"
"M-D" Diameter 2"
"M-DS" Diameter Stem 2"
"M-BO" Balloon 2 1/2"
"FL" or "FD" Flip OR Fold Leg

Wood Leg Options:

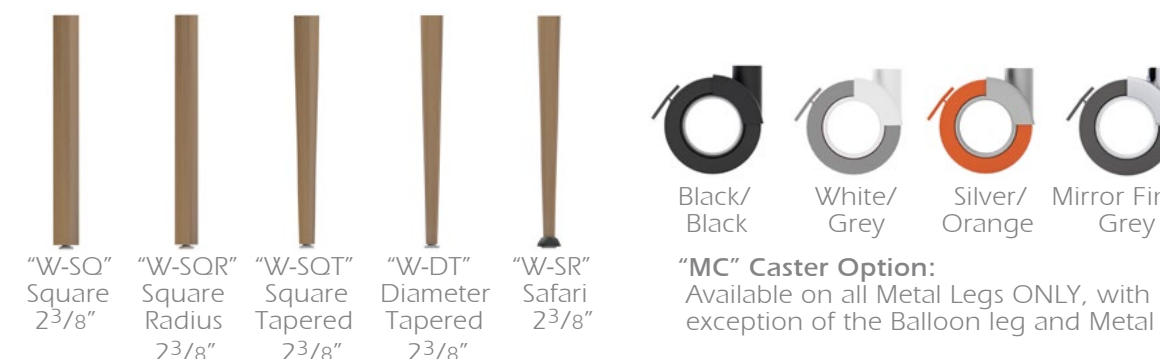

"W-SQ" Square 2 3/8"
"W-SQR" Square Radius 2 3/8"
"W-SQT" Square Tapered 2 3/8"
"W-DT" Diameter Tapered 2 3/8"
"W-SR" Safari 2 3/8"
"MC" Caster Option:
Available on all Metal Legs ONLY, with exception of the Balloon leg and Metal Bases.

MODEL NUMBER
PRODUCT
WIDTH DEPTH HEIGHT
PRICE
DESCRIPTION

*Shown Above:
TB-7224-DBN-M-D



*Rectangle Table Shape

MODEL NUMBER	PRODUCT	WIDTH	DEPTH	HEIGHT	PRICE
	Rectangle Table, 72" Width, 36" Depth	72"	36"	29"	
	DROPPED BULLNOSE Edge;				
	with WOOD Leg Option:	72"	36"	29"	
TB-7236-DBN-W-SQ	Square				\$ 1,669
TB-7236-DBN-W-SQR	Square Radius				\$ 1,669
TB-7236-DBN-W-SQT	Square Tapered				\$ 1,863
TB-7236-DBN-W-DT	Diameter Tapered				\$ 2,019
TB-7236-DBN-W-SR	Safari				\$ 2,025
	with METAL Leg Option:	72"	36"	29"	
TB-7236-DBN-M-SQ	Square				\$ 1,588
TB-7236-DBN-M-SS	Square & Stem				\$ 2,119
TB-7236-DBN-M-D	Diameter				\$ 1,588
TB-7236-DBN-M-DS	Diameter & Stem				\$ 2,119
TB-7236-DBN-M-BO	Balloon				\$ 1,719
TB-7236-DBN-MC-SQ	Square with Casters				\$ 1,869
TB-7236-DBN-MC-SS	Square & Stem with Casters				\$ 2,400
TB-7236-DBN-MC-D	Diameter with Casters				\$ 1,869
TB-7236-DBN-MC-DS	Diameter & Stem with Casters				\$ 2,400
TB-7236-DBN-FL	Flip Leg (for Nesting Tables)				\$ 2,663
TB-7236-DBN-FD	Folding Leg				\$ 2,663
	Rectangle Table, 72" Width, 42" Depth	72"	42"	29"	
	DROPPED BULLNOSE Edge;				
	with WOOD Leg Option:	72"	42"	29"	
TB-7242-DBN-W-SQ	Square				\$ 1,744
TB-7242-DBN-W-SQR	Square Radius				\$ 1,744
TB-7242-DBN-W-SQT	Square Tapered				\$ 1,931
TB-7242-DBN-W-DT	Diameter Tapered				\$ 2,094
TB-7242-DBN-W-SR	Safari				\$ 2,100
	with METAL Leg Option:	72"	42"	29"	
TB-7242-DBN-M-SQ	Square				\$ 1,663
TB-7242-DBN-M-SS	Square & Stem				\$ 2,188
TB-7242-DBN-M-D	Diameter				\$ 1,663
TB-7242-DBN-M-DS	Diameter & Stem				\$ 2,188
TB-7242-DBN-M-BO	Balloon				\$ 1,788
TB-7242-DBN-MC-SQ	Square with Casters				\$ 1,944
TB-7242-DBN-MC-SS	Square & Stem with Casters				\$ 2,475
TB-7242-DBN-MC-D	Diameter with Casters				\$ 1,944
TB-7242-DBN-MC-DS	Diameter & Stem with Casters				\$ 2,475
TB-7242-DBN-FL	Flip Leg (for Nesting Tables)				\$ 2,769
TB-7242-DBN-FD	Folding Leg				\$ 2,769

Each Table Top is constructed using a 1 1/8" thick top with a Plastic Laminate top surface.

All Metal legs are coated electrostatically with an epoxy powder coat paint.

NOTES:

- * Table heights of 25" (children), 27" (youth), and 32" (wheelchair) are available by request.
- * Color of Metal Paint must be specified at the time of order.
- * Caster Leg options are recommended for Reading/Multipurpose Tables options and not meant to be used for stationary computer workstations.
- * For all tables with casters legs, only 2 legs will have casters, and the other legs will have levelers. This will create a "wheelbarrow" style of table which will ensure ease of mobility.
- * Color of the Caster Option must be specified at the time of order.
- * For the Flip OR Fold Leg option, one T-based leg comes with 2 hidden casters as shown in the image below.

Edge Option:

"DBN"
3/4" Dropped Bullnoses Edge

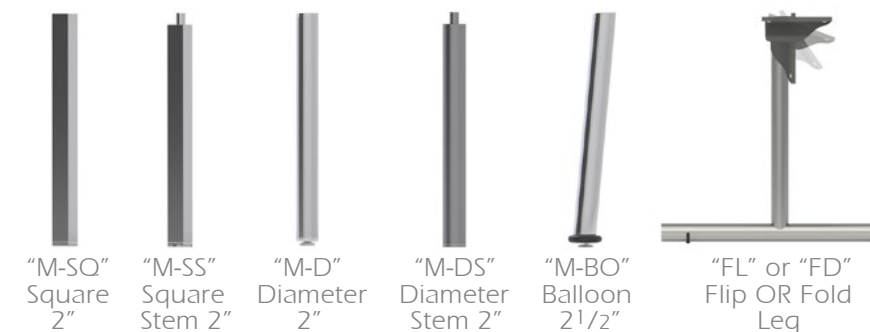
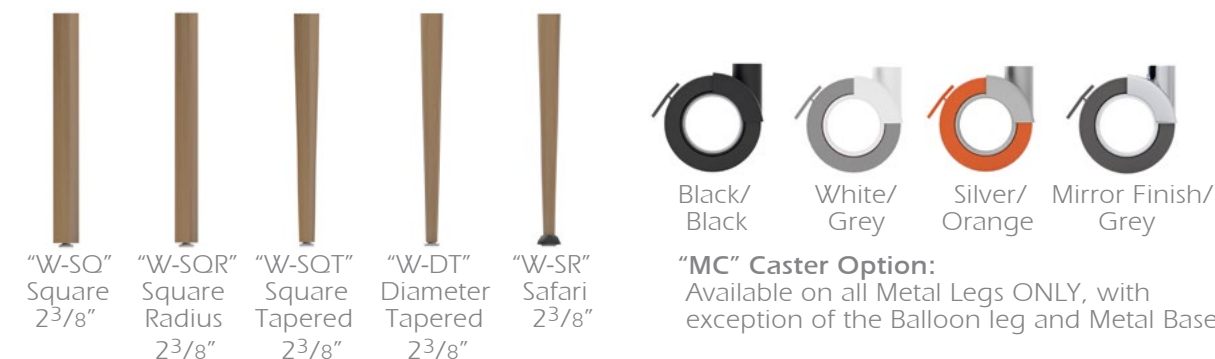
Metal Leg Options:

Wood Leg Options:

"MC" Caster Option:
Available on all Metal Legs ONLY, with exception of the Balloon leg and Metal Bases.

MODEL NUMBER

PRODUCT

WIDTH DEPTH HEIGHT

PRICE

DESCRIPTION



*Shown Above:
TB-7224-DCH-M-D



*Rectangle Table Shape

MODEL NUMBER	PRODUCT	WIDTH	DEPTH	HEIGHT	PRICE
	Rectangle Table, 72" Width, 24" Depth	72"	24"	29"	
	DROPPED CHAMFERED Edge;				
	with WOOD Leg Option:	72"	24"	29"	
TB-7224-DCH-W-SQ	Square				\$ 1,525
TB-7224-DCH-W-SQR	Square Radius				\$ 1,525
TB-7224-DCH-W-SQT	Square Tapered				\$ 1,719
TB-7224-DCH-W-DT	Diameter Tapered				\$ 1,881
TB-7224-DCH-W-SR	Safari				\$ 1,888
	with METAL Leg Option:	72"	24"	29"	
TB-7224-DCH-M-SQ	Square				\$ 1,450
TB-7224-DCH-M-SS	Square & Stem				\$ 1,975
TB-7224-DCH-M-D	Diameter				\$ 1,450
TB-7224-DCH-M-DS	Diameter & Stem				\$ 1,975
TB-7224-DCH-M-BO	Balloon				\$ 1,575
TB-7224-DCH-MC-SQ	Square with Casters				\$ 1,725
TB-7224-DCH-MC-SS	Square & Stem with Casters				\$ 2,256
TB-7224-DCH-MC-D	Diameter with Casters				\$ 1,725
TB-7224-DCH-MC-DS	Diameter & Stem with Casters				\$ 2,256
TB-7224-DCH-FL	Flip Leg (for Nesting Tables)				\$ 2,494
TB-7224-DCH-FD	Folding Leg				\$ 2,494
	Rectangle Table, 72" Width, 30" Depth	72"	30"	29"	
	DROPPED CHAMFERED Edge;				
	with WOOD Leg Option:	72"	30"	29"	
TB-7230-DCH-W-SQ	Square				\$ 1,600
TB-7230-DCH-W-SQR	Square Radius				\$ 1,600
TB-7230-DCH-W-SQT	Square Tapered				\$ 1,788
TB-7230-DCH-W-DT	Diameter Tapered				\$ 1,950
TB-7230-DCH-W-SR	Safari				\$ 1,956
	with METAL Leg Option:	72"	30"	29"	
TB-7230-DCH-M-SQ	Square				\$ 1,519
TB-7230-DCH-M-SS	Square & Stem				\$ 2,044
TB-7230-DCH-M-D	Diameter				\$ 1,519
TB-7230-DCH-M-DS	Diameter & Stem				\$ 2,044
TB-7230-DCH-M-BO	Balloon				\$ 1,644
TB-7230-DCH-MC-SQ	Square with Casters				\$ 1,800
TB-7230-DCH-MC-SS	Square & Stem with Casters				\$ 2,331
TB-7230-DCH-MC-D	Diameter with Casters				\$ 1,800
TB-7230-DCH-MC-DS	Diameter & Stem with Casters				\$ 2,331
TB-7230-DCH-FL	Flip Leg (for Nesting Tables)				\$ 2,581
TB-7230-DCH-FD	Folding Leg				\$ 2,581

Each Table Top is constructed using a 1 1/8" thick top with a Plastic Laminate top surface.

All Metal legs are coated electrostatically with an epoxy powder coat paint.

NOTES:

* Table heights of 25" (children), 27" (youth), and 32" (wheelchair) are available by request.

* Color of Metal Paint must be specified at the time of order.

* Caster Leg options are recommended for Reading/Multipurpose Tables options and not meant to be used for stationary computer workstations.

* For all tables with casters legs, only 2 legs will have casters, and the other legs will have levelers. This will create a "wheelbarrow" style of table which will ensure ease of mobility.

* Color of the Caster Option must be specified at the time of order.

* For the Flip OR Fold Leg option, one T-based leg comes with 2 hidden casters as shown in the

image below

Edge Option:



"DCH"
3/4" Dropped Chamfered Edge

Metal Leg Options:



"M-SQ" Square 2"
"M-SS" Square Stem 2"
"M-D" Diameter 2"
"M-DS" Diameter Stem 2"
"M-BO" Balloon 2 1/2"
"FL" or "FD" Flip OR Fold Leg

Wood Leg Options:



"W-SQ" Square 2 3/8"
"W-SQR" Square Radius 2 3/8"
"W-SQT" Square Tapered 2 3/8"
"W-DT" Diameter Tapered 2 3/8"
"W-SR" Safari 2 3/8"



Black/Black
White/Grey
Silver/Orange
Mirror Finish/Grey
"MC" Caster Option:
Available on all Metal Legs ONLY, with exception of the Balloon leg and Metal Bases.

MODEL NUMBER

PRODUCT

WIDTH DEPTH HEIGHT

PRICE

DESCRIPTION



*Shown Above:
TB-7224-DCH-M-D



*Rectangle Table Shape

MODEL NUMBER	PRODUCT	WIDTH	DEPTH	HEIGHT	PRICE
	Rectangle Table, 72" Width, 36" Depth	72"	36"	29"	
	DROPPED CHAMFERED Edge;				
	with WOOD Leg Option:	72"	36"	29"	
TB-7236-DCH-W-SQ	Square				\$ 1,669
TB-7236-DCH-W-SQR	Square Radius				\$ 1,669
TB-7236-DCH-W-SQT	Square Tapered				\$ 1,863
TB-7236-DCH-W-DT	Diameter Tapered				\$ 2,019
TB-7236-DCH-W-SR	Safari				\$ 2,025
	with METAL Leg Option:	72"	36"	29"	
TB-7236-DCH-M-SQ	Square				\$ 1,588
TB-7236-DCH-M-SS	Square & Stem				\$ 2,119
TB-7236-DCH-M-D	Diameter				\$ 1,588
TB-7236-DCH-M-DS	Diameter & Stem				\$ 2,119
TB-7236-DCH-M-BO	Balloon				\$ 1,719
TB-7236-DCH-MC-SQ	Square with Casters				\$ 1,869
TB-7236-DCH-MC-SS	Square & Stem with Casters				\$ 2,400
TB-7236-DCH-MC-D	Diameter with Casters				\$ 1,869
TB-7236-DCH-MC-DS	Diameter & Stem with Casters				\$ 2,400
TB-7236-DCH-FL	Flip Leg (for Nesting Tables)				\$ 2,663
TB-7236-DCH-FD	Folding Leg				\$ 2,663
	Rectangle Table, 72" Width, 42" Depth	72"	42"	29"	
	DROPPED CHAMFERED Edge;				
	with WOOD Leg Option:	72"	42"	29"	
TB-7242-DCH-W-SQ	Square				\$ 1,744
TB-7242-DCH-W-SQR	Square Radius				\$ 1,744
TB-7242-DCH-W-SQT	Square Tapered				\$ 1,931
TB-7242-DCH-W-DT	Diameter Tapered				\$ 2,094
TB-7242-DCH-W-SR	Safari				\$ 2,100
	with METAL Leg Option:	72"	42"	29"	
TB-7242-DCH-M-SQ	Square				\$ 1,663
TB-7242-DCH-M-SS	Square & Stem				\$ 2,188
TB-7242-DCH-M-D	Diameter				\$ 1,663
TB-7242-DCH-M-DS	Diameter & Stem				\$ 2,188
TB-7242-DCH-M-BO	Balloon				\$ 1,788
TB-7242-DCH-MC-SQ	Square with Casters				\$ 1,944
TB-7242-DCH-MC-SS	Square & Stem with Casters				\$ 2,475
TB-7242-DCH-MC-D	Diameter with Casters				\$ 1,944
TB-7242-DCH-MC-DS	Diameter & Stem with Casters				\$ 2,475
TB-7242-DCH-FL	Flip Leg (for Nesting Tables)				\$ 2,769
TB-7242-DCH-FD	Folding Leg				\$ 2,769

Each Table Top is constructed using a 1 1/8" thick top with a Plastic Laminate top surface.

All Metal legs are coated electrostatically with an epoxy powder coat paint.

NOTES:

- * Table heights of 25" (children), 27" (youth), and 32" (wheelchair) are available by request.
- * Color of Metal Paint must be specified at the time of order.
- * Caster Leg options are recommended for Reading/Multipurpose Tables options and not meant to be used for stationary computer workstations.
- * For all tables with casters legs, only 2 legs will have casters, and the other legs will have levelers. This will create a "wheelbarrow" style of table which will ensure ease of mobility.
- * Color of the Caster Option must be specified at the time of order.
- * For the Flip OR Fold Leg option, one T-based leg comes with 2 hidden casters as shown in the

image below

Edge Option:



"DCH"
3/4" Dropped Chamfered Edge

Metal Leg Options:



"M-SQ" Square 2"
"M-SS" Square Stem 2"
"M-D" Diameter 2"
"M-DS" Diameter Stem 2"
"M-BO" Balloon 2 1/2"
"FL" or "FD" Flip OR Fold Leg

Wood Leg Options:

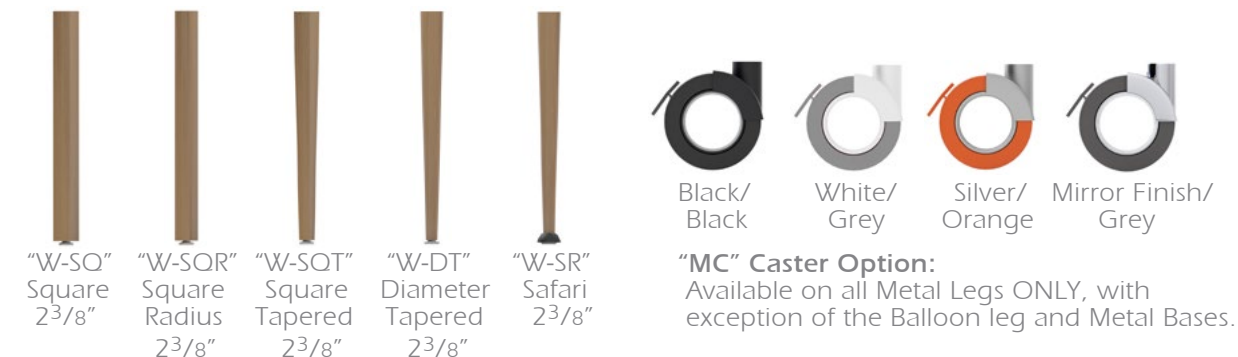

"W-SQ" Square 2 3/8"
"W-SQR" Square Radius 2 3/8"
"W-SQT" Square Tapered 2 3/8"
"W-DT" Diameter Tapered 2 3/8"
"W-SR" Safari 2 3/8"

"MC" Caster Option:
Available on all Metal Legs ONLY, with exception of the Balloon leg and Metal Bases.

MODEL NUMBER

PRODUCT

WIDTH DEPTH HEIGHT

PRICE

DESCRIPTION



*Shown Above:
TB-7224-AL-M-D



*Rectangle Table Shape

MODEL NUMBER	PRODUCT	WIDTH	DEPTH	HEIGHT
	Rectangle Table, 72" Width, 24" Depth	72"	24"	29"
	ALUMINUM Edge;			
	with WOOD Leg Option:	72"	24"	29"
TB-7224-AL-W-SQ	Square			
TB-7224-AL-W-SQR	Square Radius			
TB-7224-AL-W-SQT	Square Tapered			
TB-7224-AL-W-DT	Diameter Tapered			
TB-7224-AL-W-SR	Safari			
	with METAL Leg Option:	72"	24"	29"
TB-7224-AL-M-SQ	Square			
TB-7224-AL-M-SS	Square & Stem			
TB-7224-AL-M-D	Diameter			
TB-7224-AL-M-DS	Diameter & Stem			
TB-7224-AL-M-BO	Balloon			
TB-7224-AL-MC-SQ	Square with Casters			
TB-7224-AL-MC-SS	Square & Stem with Casters			
TB-7224-AL-MC-D	Diameter with Casters			
TB-7224-AL-MC-DS	Diameter & Stem with Casters			
TB-7224-AL-FL	Flip Leg (for Nesting Tables)			
TB-7224-AL-FD	Folding Leg			
	Rectangle Table, 72" Width, 30" Depth	72"	30"	29"
	ALUMINUM Edge;			
	with WOOD Leg Option:	72"	30"	29"
TB-7230-AL-W-SQ	Square			
TB-7230-AL-W-SQR	Square Radius			
TB-7230-AL-W-SQT	Square Tapered			
TB-7230-AL-W-DT	Diameter Tapered			
TB-7230-AL-W-SR	Safari			
	with METAL Leg Option:	72"	30"	29"
TB-7230-AL-M-SQ	Square			
TB-7230-AL-M-SS	Square & Stem			
TB-7230-AL-M-D	Diameter			
TB-7230-AL-M-DS	Diameter & Stem			
TB-7230-AL-M-BO	Balloon			
TB-7230-AL-MC-SQ	Square with Casters			
TB-7230-AL-MC-SS	Square & Stem with Casters			
TB-7230-AL-MC-D	Diameter with Casters			
TB-7230-AL-MC-DS	Diameter & Stem with Casters			
TB-7230-AL-FL	Flip Leg (for Nesting Tables)			
TB-7230-AL-FD	Folding Leg			

\$ 1,338
\$ 1,338
\$ 1,525
\$ 1,688
\$ 1,694

\$ 1,256
\$ 1,781
\$ 1,256
\$ 1,781
\$ 1,388
\$ 1,538
\$ 2,069
\$ 1,538
\$ 2,069
\$ 2,306
\$ 2,306

\$ 1,394
\$ 1,394
\$ 1,588
\$ 1,744
\$ 1,756

\$ 1,313
\$ 1,844
\$ 1,313
\$ 1,844
\$ 1,444
\$ 1,600
\$ 2,125
\$ 1,600
\$ 2,125
\$ 2,381
\$ 2,381

Each Table Top is constructed using a 1 1/8" thick top with a Plastic Laminate top surface.

All Metal legs are coated electrostatically with an epoxy powder coat paint.

NOTES:

- * Table heights of 25" (children), 27" (youth), and 32" (wheelchair) are available by request.
- * Color of Metal Paint must be specified at the time of order.
- * Caster Leg options are recommended for Reading/Multipurpose Tables options and not meant to be used for stationary computer workstations.
- * For all tables with casters legs, only 2 legs will have casters, and the other legs will have levelers. This will create a "wheelbarrow" style of table which will ensure ease of mobility.
- * Color of the Caster Option must be specified at the time of order.
- * For the Flip OR Fold Leg option, one T-based leg comes with 2 hidden casters as shown in the image below.

Edge Option:



"AL"

3mm Aluminum Edge *All table corners will be given a 6-inch radius for this edge option.

Metal Leg Options:



"M-SQ" Square 2"
"M-SS" Square Stem 2"
"M-D" Diameter 2"
"M-DS" Diameter Stem 2"
"M-BO" Balloon 2 1/2"
"FL" or "FD" Flip OR Fold Leg

Wood Leg Options:

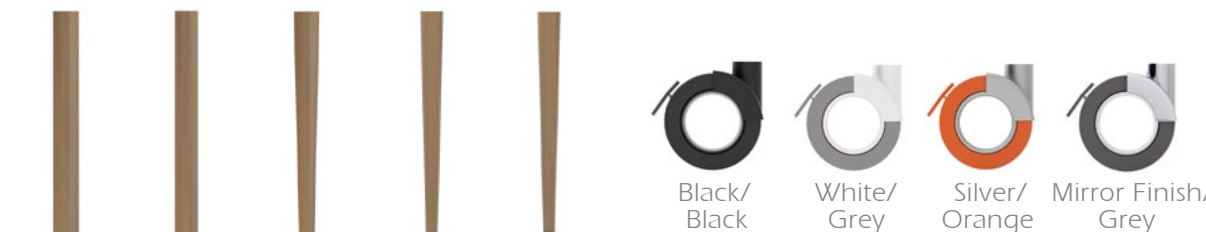

"W-SQ" Square 2 3/8"
"W-SQR" Square Radius 2 3/8"
"W-SQT" Square Tapered 2 3/8"
"W-DT" Diameter Tapered 2 3/8"
"W-SR" Safari 2 3/8"

"MC" Caster Option:
Available on all Metal Legs ONLY, with exception of the Balloon leg and Metal Bases.

MODEL NUMBER

PRODUCT

WIDTH DEPTH HEIGHT

PRICE

DESCRIPTION



*Shown Above:
TB-7224-AL-M-D



*Rectangle Table Shape

MODEL NUMBER	PRODUCT	WIDTH	DEPTH	HEIGHT
	Rectangle Table, 72" Width, 36" Depth	72"	36"	29"
	ALUMINUM Edge;			
	with WOOD Leg Option:	72"	36"	29"
TB-7236-AL-W-SQ	Square			
TB-7236-AL-W-SQR	Square Radius			
TB-7236-AL-W-SQT	Square Tapered			
TB-7236-AL-W-DT	Diameter Tapered			
TB-7236-AL-W-SR	Safari			
	with METAL Leg Option:	72"	36"	29"
TB-7236-AL-M-SQ	Square			
TB-7236-AL-M-SS	Square & Stem			
TB-7236-AL-M-D	Diameter			
TB-7236-AL-M-DS	Diameter & Stem			
TB-7236-AL-M-BO	Balloon			
TB-7236-AL-MC-SQ	Square with Casters			
TB-7236-AL-MC-SS	Square & Stem with Casters			
TB-7236-AL-MC-D	Diameter with Casters			
TB-7236-AL-MC-DS	Diameter & Stem with Casters			
TB-7236-AL-FL	Flip Leg (for Nesting Tables)			
TB-7236-AL-FD	Folding Leg			
	Rectangle Table, 72" Width, 42" Depth	72"	42"	29"
	ALUMINUM Edge;			
	with WOOD Leg Option:	72"	42"	29"
TB-7242-AL-W-SQ	Square			
TB-7242-AL-W-SQR	Square Radius			
TB-7242-AL-W-SQT	Square Tapered			
TB-7242-AL-W-DT	Diameter Tapered			
TB-7242-AL-W-SR	Safari			
	with METAL Leg Option:	72"	42"	29"
TB-7242-AL-M-SQ	Square			
TB-7242-AL-M-SS	Square & Stem			
TB-7242-AL-M-D	Diameter			
TB-7242-AL-M-DS	Diameter & Stem			
TB-7242-AL-M-BO	Balloon			
TB-7242-AL-MC-SQ	Square with Casters			
TB-7242-AL-MC-SS	Square & Stem with Casters			
TB-7242-AL-MC-D	Diameter with Casters			
TB-7242-AL-MC-DS	Diameter & Stem with Casters			
TB-7242-AL-FL	Flip Leg (for Nesting Tables)			
TB-7242-AL-FD	Folding Leg			

Each Table Top is constructed using a 1 1/8" thick top with a Plastic Laminate top surface.

All Metal legs are coated electrostatically with an epoxy powder coat paint.

NOTES:

- * Table heights of 25" (children), 27" (youth), and 32" (wheelchair) are available by request.
- * Color of Metal Paint must be specified at the time of order.
- * Caster Leg options are recommended for Reading/Multipurpose Tables options and not meant to be used for stationary computer workstations.
- * For all tables with casters legs, only 2 legs will have casters, and the other legs will have levelers. This will create a "wheelbarrow" style of table which will ensure ease of mobility.
- * Color of the Caster Option must be specified at the time of order.
- * For the Flip OR Fold Leg option, one T-based leg comes with 2 hidden casters as shown in the image below.

\$ 1,456
\$ 1,456
\$ 1,644
\$ 1,806
\$ 1,813

\$ 1,375
\$ 1,900
\$ 1,375
\$ 1,900
\$ 1,506
\$ 1,656
\$ 2,188
\$ 1,656
\$ 2,188
\$ 2,450
\$ 2,450

Edge Option:



"AL"

3mm Aluminum Edge *All table corners will be given a 6-inch radius for this edge option.

Metal Leg Options:

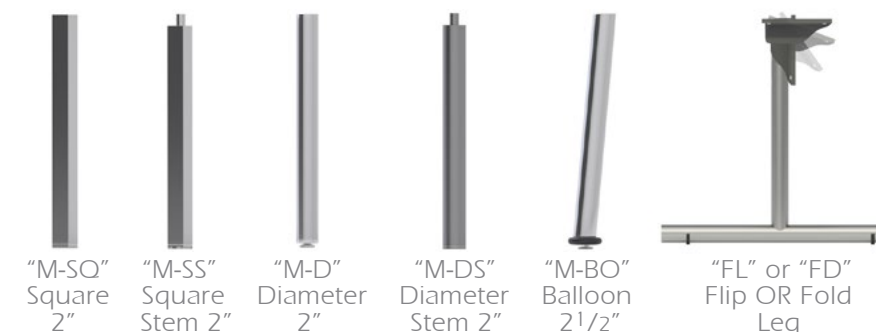

"M-SQ" Square 2"
"M-SS" Square Stem 2"
"M-D" Diameter 2"
"M-DS" Diameter Stem 2"
"M-BO" Balloon 2 1/2"
"FL" or "FD" Flip OR Fold Leg

Wood Leg Options:

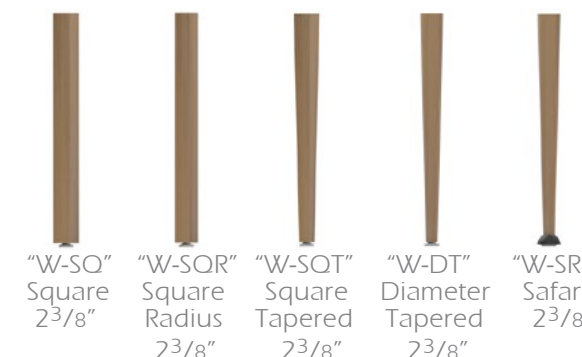

"W-SQ" Square 2 3/8"
"W-SQR" Square Radius 2 3/8"
"W-SQT" Square Tapered 2 3/8"
"W-DT" Diameter Tapered 2 3/8"
"W-SR" Safari 2 3/8"



"MC" Caster Option:
Available on all Metal Legs ONLY, with exception of the Balloon leg and Metal Bases.

MODEL NUMBER **PRODUCT** **WIDTH** **DEPTH** **HEIGHT**



*Shown Above:
TB-8442-AC-M-D



*Rectangle Table Shape

MODEL NUMBER	PRODUCT	WIDTH	DEPTH	HEIGHT
	Rectangle Table, 84" Width, 36" Depth	84"	36"	29"
	ACRYLIC Edge;			
	with WOOD Leg Option:	84"	36"	29"
TB-8436-AC-W-SQ	Square			
TB-8436-AC-W-SQR	Square Radius			
TB-8436-AC-W-SQT	Square Tapered			
TB-8436-AC-W-DT	Diameter Tapered			
TB-8436-AC-W-SR	Safari			
	with METAL Leg Option:	84"	36"	29"
TB-8436-AC-M-SQ	Square			
TB-8436-AC-M-SS	Square & Stem			
TB-8436-AC-M-D	Diameter			
TB-8436-AC-M-DS	Diameter & Stem			
TB-8436-AC-M-BO	Balloon			
TB-8436-AC-MC-SQ	Square with Casters			
TB-8436-AC-MC-SS	Square & Stem with Casters			
TB-8436-AC-MC-D	Diameter with Casters			
TB-8436-AC-MC-DS	Diameter & Stem with Casters			
TB-8436-AC-FL	Flip Leg (for Nesting Tables)			
TB-8436-AC-FD	Folding Leg			
	Rectangle Table, 84" Width, 42" Depth	84"	42"	29"
	ACRYLIC Edge;			
	with WOOD Leg Option:	84"	42"	29"
TB-8442-AC-W-SQ	Square			
TB-8442-AC-W-SQR	Square Radius			
TB-8442-AC-W-SQT	Square Tapered			
TB-8442-AC-W-DT	Diameter Tapered			
TB-8442-AC-W-SR	Safari			
	with METAL Leg Option:	84"	42"	29"
TB-8442-AC-M-SQ	Square			
TB-8442-AC-M-SS	Square & Stem			
TB-8442-AC-M-D	Diameter			
TB-8442-AC-M-DS	Diameter & Stem			
TB-8442-AC-M-BO	Balloon			
TB-8442-AC-MC-SQ	Square with Casters			
TB-8442-AC-MC-SS	Square & Stem with Casters			
TB-8442-AC-MC-D	Diameter with Casters			
TB-8442-AC-MC-DS	Diameter & Stem with Casters			
TB-8442-AC-FL	Flip Leg (for Nesting Tables)			
TB-8442-AC-FD	Folding Leg			

PRICE **DESCRIPTION**

Each Table Top is constructed using a 1" thick top with a Plastic Laminate top surface.

All Metal legs are coated electrostatically with an epoxy powder coat paint.

NOTES:

- * Table heights of 25" (children), 27" (youth), and 32" (wheelchair) are available by request.
- * Color of Metal Paint must be specified at the time of order.
- * Caster Leg options are recommended for Reading/Multipurpose Tables options and not meant to be used for stationary computer workstations.
- * For all tables with casters legs, only 2 legs will have casters, and the other legs will have levelers. This will create a "wheelbarrow" style of table which will ensure ease of mobility.
- * Color of the Caster Option must be specified at the time of order.
- * For the Flip OR Fold Leg option, one T-based leg comes with 2 hidden casters as shown in the image below.

\$ 1,381
\$ 1,381
\$ 1,569
\$ 1,731
\$ 1,744

\$ 1,300
\$ 1,831
\$ 1,300
\$ 1,831
\$ 1,425
\$ 1,588
\$ 2,113
\$ 1,588
\$ 2,113
\$ 2,375
\$ 2,375

Edge Option:

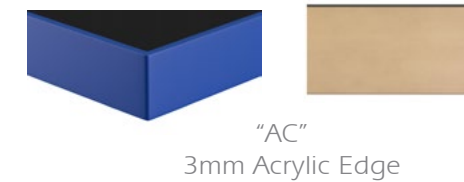

"AC"
3mm Acrylic Edge

Metal Leg Options:



"M-SQ" Square 2"
"M-SS" Square Stem 2"
"M-D" Diameter 2"
"M-DS" Diameter Stem 2"
"M-BO" Balloon 2 1/2"
"FL" or "FD" Flip OR Fold Leg

Wood Leg Options:

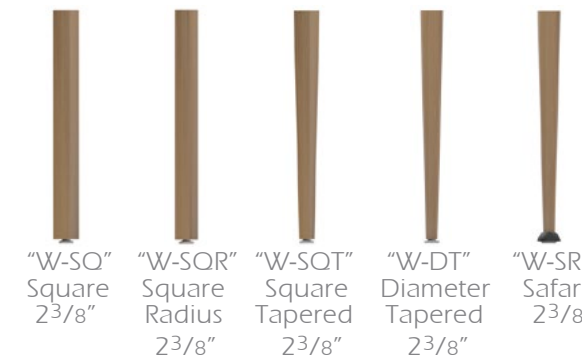

"W-SQ" Square 2 3/8"
"W-SQR" Square Radius 2 3/8"
"W-SQT" Square Tapered 2 3/8"
"W-DT" Diameter Tapered 2 3/8"
"W-SR" Safari 2 3/8"



Black/Black White/Grey Silver/Orange Mirror Finish/Grey

"MC" Caster Option:
Available on all Metal Legs ONLY, with exception of the Balloon leg and Metal Bases.

MODEL NUMBER

PRODUCT

WIDTH DEPTH HEIGHT

PRICE

DESCRIPTION



*Shown Above:
TB-8442-AC-M-D



*Rectangle Table Shape

MODEL NUMBER	PRODUCT	WIDTH	DEPTH	HEIGHT
	Rectangle Table, 84" Width, 48" Depth	84"	48"	29"
	ACRYLIC Edge;			
	with WOOD Leg Option:	84"	48"	29"
TB-8448-AC-W-SQ	Square			
TB-8448-AC-W-SQR	Square Radius			
TB-8448-AC-W-SQT	Square Tapered			
TB-8448-AC-W-DT	Diameter Tapered			
TB-8448-AC-W-SR	Safari			
	with METAL Leg Option:	84"	48"	29"
TB-8448-AC-M-SQ	Square			
TB-8448-AC-M-SS	Square & Stem			
TB-8448-AC-M-D	Diameter			
TB-8448-AC-M-DS	Diameter & Stem			
TB-8448-AC-M-BO	Balloon			
TB-8448-AC-MC-SQ	Square with Casters			
TB-8448-AC-MC-SS	Square & Stem with Casters			
TB-8448-AC-MC-D	Diameter with Casters			
TB-8448-AC-MC-DS	Diameter & Stem with Casters			
TB-8448-AC-FL	Flip Leg (for Nesting Tables)			
TB-8448-AC-FD	Folding Leg			

Each Table Top is constructed using a 1" thick top with a Plastic Laminate top surface.

All Metal legs are coated electrostatically with an epoxy powder coat paint.

NOTES:

- * Table heights of 25" (children), 27" (youth), and 32" (wheelchair) are available by request.
- * Color of Metal Paint must be specified at the time of order.
- * Caster Leg options are recommended for Reading/Multipurpose Tables options and not meant to be used for stationary computer workstations.
- * For all tables with casters legs, only 2 legs will have casters, and the other legs will have levelers. This will create a "wheelbarrow" style of table which will ensure ease of mobility.
- * Color of the Caster Option must be specified at the time of order.
- * For the Flip OR Fold Leg option, one T-based leg comes with 2 hidden casters as shown in the image below.

\$ 1,506
\$ 1,506
\$ 1,694
\$ 1,856
\$ 1,863
\$ 1,425
\$ 1,950
\$ 1,425
\$ 1,950
\$ 1,550
\$ 1,706
\$ 2,238
\$ 1,706
\$ 2,238
\$ 2,531
\$ 2,531

Edge Option:

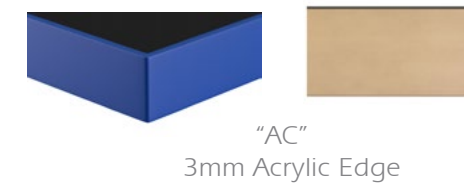

"AC"
3mm Acrylic Edge

Metal Leg Options:



"M-SQ" Square 2"
"M-SS" Square Stem 2"
"M-D" Diameter 2"
"M-DS" Diameter Stem 2"
"M-BO" Balloon 2 1/2"
"FL" or "FD" Flip OR Fold Leg

Wood Leg Options:

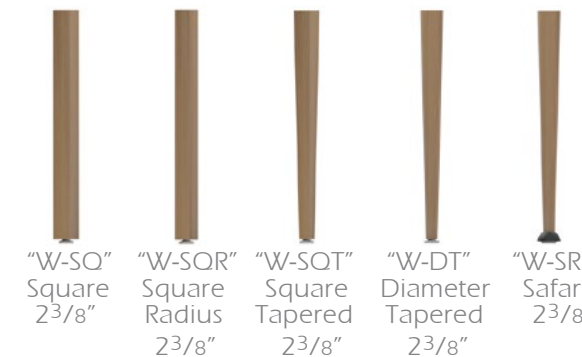

"W-SQ" Square 2 3/8"
"W-SQR" Square Radius 2 3/8"
"W-SQT" Square Tapered 2 3/8"
"W-DT" Diameter Tapered 2 3/8"
"W-SR" Safari 2 3/8"



Black/Black
White/Grey
Silver/Orange
Mirror Finish/Grey

"MC" Caster Option:
Available on all Metal Legs ONLY, with exception of the Balloon leg and Metal Bases.

MODEL NUMBER

PRODUCT

WIDTH DEPTH HEIGHT

PRICE

DESCRIPTION



*Shown Above:
TB-8442-SQ-M-D



*Rectangle Table Shape

MODEL NUMBER	PRODUCT	WIDTH	DEPTH	HEIGHT	PRICE
	Rectangle Table, 84" Width, 36" Depth	84"	36"	29"	
	SQUARE Edge;				
	with WOOD Leg Option:	84"	36"	29"	
TB-8436-SQ-W-SQ	Square				\$ 1,619
TB-8436-SQ-W-SQR	Square Radius				\$ 1,619
TB-8436-SQ-W-SQT	Square Tapered				\$ 1,806
TB-8436-SQ-W-DT	Diameter Tapered				\$ 1,969
TB-8436-SQ-W-SR	Safari				\$ 1,981
	with METAL Leg Option:	84"	36"	29"	
TB-8436-SQ-M-SQ	Square				\$ 1,538
TB-8436-SQ-M-SS	Square & Stem				\$ 2,069
TB-8436-SQ-M-D	Diameter				\$ 1,538
TB-8436-SQ-M-DS	Diameter & Stem				\$ 2,069
TB-8436-SQ-M-BO	Balloon				\$ 1,663
TB-8436-SQ-MC-SQ	Square with Casters				\$ 1,825
TB-8436-SQ-MC-SS	Square & Stem with Casters				\$ 2,350
TB-8436-SQ-MC-D	Diameter with Casters				\$ 1,825
TB-8436-SQ-MC-DS	Diameter & Stem with Casters				\$ 2,350
TB-8436-SQ-FL	Flip Leg (for Nesting Tables)				\$ 2,613
TB-8436-SQ-FD	Folding Leg				\$ 2,613
	Rectangle Table, 84" Width, 42" Depth	84"	42"	29"	
	SQUARE Edge;				
	with WOOD Leg Option:	84"	42"	29"	
TB-8442-SQ-W-SQ	Square				\$ 1,688
TB-8442-SQ-W-SQR	Square Radius				\$ 1,688
TB-8442-SQ-W-SQT	Square Tapered				\$ 1,881
TB-8442-SQ-W-DT	Diameter Tapered				\$ 2,044
TB-8442-SQ-W-SR	Safari				\$ 2,050
	with METAL Leg Option:	84"	42"	29"	
TB-8442-SQ-M-SQ	Square				\$ 1,606
TB-8442-SQ-M-SS	Square & Stem				\$ 2,138
TB-8442-SQ-M-D	Diameter				\$ 1,606
TB-8442-SQ-M-DS	Diameter & Stem				\$ 2,138
TB-8442-SQ-M-BO	Balloon				\$ 1,738
TB-8442-SQ-MC-SQ	Square with Casters				\$ 1,894
TB-8442-SQ-MC-SS	Square & Stem with Casters				\$ 2,419
TB-8442-SQ-MC-D	Diameter with Casters				\$ 1,894
TB-8442-SQ-MC-DS	Diameter & Stem with Casters				\$ 2,419
TB-8442-SQ-FL	Flip Leg (for Nesting Tables)				\$ 2,713
TB-8442-SQ-FD	Folding Leg				\$ 2,713

Each Table Top is constructed using a 1 1/8" thick top with a Plastic Laminate top surface.

All Metal legs are coated electrostatically with an epoxy powder coat paint.

NOTES:

- * Table heights of 25" (children), 27" (youth), and 32" (wheelchair) are available by request.
- * Color of Metal Paint must be specified at the time of order.
- * Caster Leg options are recommended for Reading/Multipurpose Tables options and not meant to be used for stationary computer workstations.
- * For all tables with casters legs, only 2 legs will have casters, and the other legs will have levelers. This will create a "wheelbarrow" style of table which will ensure ease of mobility.
- * Color of the Caster Option must be specified at the time of order.
- * For the Flip OR Fold Leg option, one T-based leg comes with 2 hidden casters as shown in the image below.

Edge Option:



"SQ"
1/4" Square Edge

Metal Leg Options:

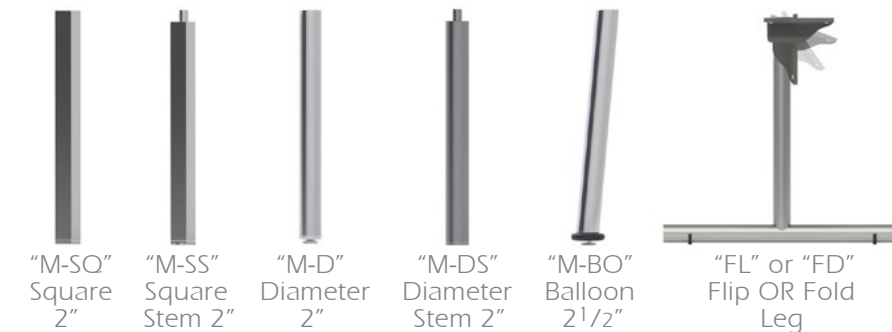

Wood Leg Options:

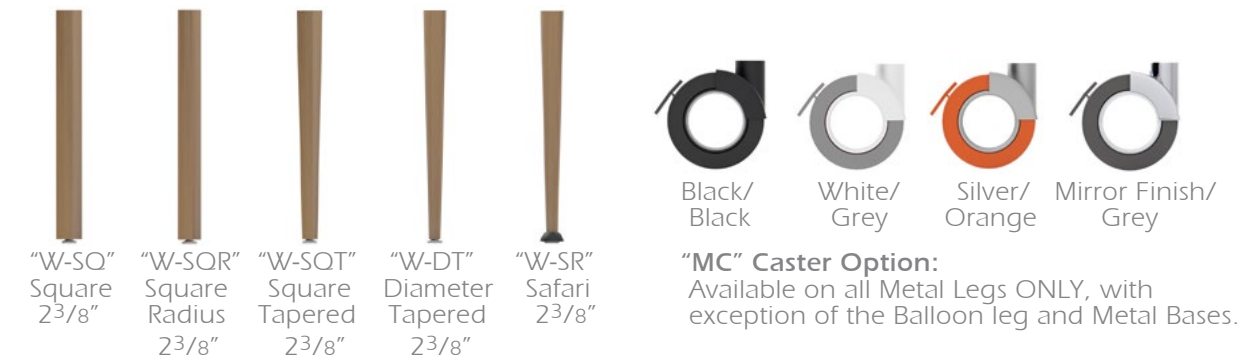

"MC" Caster Option:
Available on all Metal Legs ONLY, with exception of the Balloon leg and Metal Bases.

MODEL NUMBER

PRODUCT

WIDTH DEPTH HEIGHT

PRICE

DESCRIPTION



*Shown Above:
TB-8442-SQ-M-D



*Rectangle Table Shape

MODEL NUMBER	PRODUCT	WIDTH	DEPTH	HEIGHT	PRICE
	Rectangle Table, 84" Width, 48" Depth	84"	48"	29"	
	SQUARE Edge;				
	with WOOD Leg Option:	84"	48"	29"	
TB-8448-SQ-W-SQ	Square				\$ 1,763
TB-8448-SQ-W-SQR	Square Radius				\$ 1,763
TB-8448-SQ-W-SQT	Square Tapered				\$ 1,956
TB-8448-SQ-W-DT	Diameter Tapered				\$ 2,119
TB-8448-SQ-W-SR	Safari				\$ 2,125
	with METAL Leg Option:	84"	48"	29"	
TB-8448-SQ-M-SQ	Square				\$ 1,688
TB-8448-SQ-M-SS	Square & Stem				\$ 2,213
TB-8448-SQ-M-D	Diameter				\$ 1,688
TB-8448-SQ-M-DS	Diameter & Stem				\$ 2,213
TB-8448-SQ-M-BO	Balloon				\$ 1,813
TB-8448-SQ-MC-SQ	Square with Casters				\$ 1,963
TB-8448-SQ-MC-SS	Square & Stem with Casters				\$ 2,494
TB-8448-SQ-MC-D	Diameter with Casters				\$ 1,963
TB-8448-SQ-MC-DS	Diameter & Stem with Casters				\$ 2,494
TB-8448-SQ-FL	Flip Leg (for Nesting Tables)				\$ 2,794
TB-8448-SQ-FD	Folding Leg				\$ 2,794

Each Table Top is constructed using a 1 1/8" thick top with a Plastic Laminate top surface.

All Metal legs are coated electrostatically with an epoxy powder coat paint.

NOTES:

- * Table heights of 25" (children), 27" (youth), and 32" (wheelchair) are available by request.
- * Color of Metal Paint must be specified at the time of order.
- * Caster Leg options are recommended for Reading/Multipurpose Tables options and not meant to be used for stationary computer workstations.
- * For all tables with casters legs, only 2 legs will have casters, and the other legs will have levelers. This will create a "wheelbarrow" style of table which will ensure ease of mobility.
- * Color of the Caster Option must be specified at the time of order.
- * For the Flip OR Fold Leg option, one T-based leg comes with 2 hidden casters as shown in the image below.

Edge Option:



"SQ"
1/4" Square Edge

Metal Leg Options:

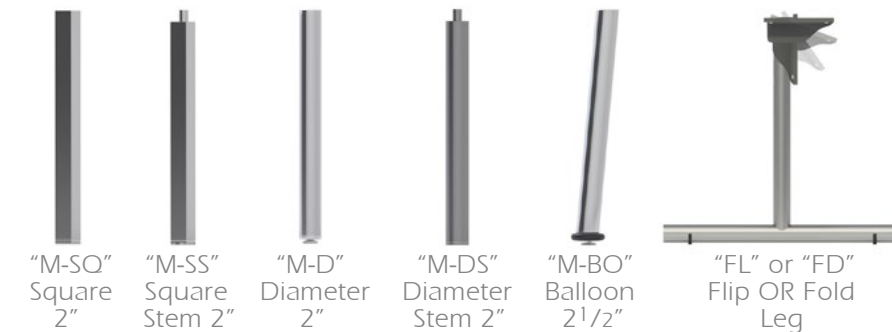

"M-SQ" Square 2"
"M-SS" Square Stem 2"
"M-D" Diameter 2"
"M-DS" Diameter Stem 2"
"M-BO" Balloon 2 1/2"
"FL" or "FD" Flip OR Fold Leg

Wood Leg Options:

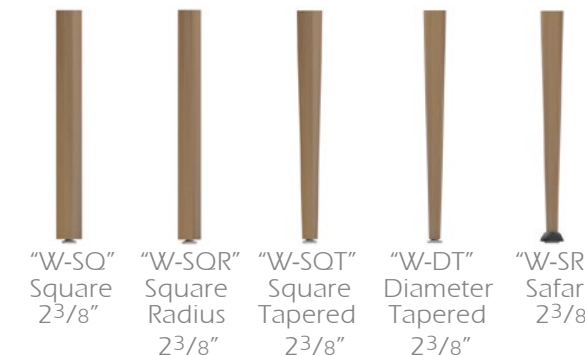

"W-SQ" Square 2 3/8"
"W-SQR" Square Radius 2 3/8"
"W-SQT" Square Tapered 2 3/8"
"W-DT" Diameter Tapered 2 3/8"
"W-SR" Safari 2 3/8"



Black/Black
White/Grey
Silver/Orange
Mirror Finish/Grey
"MC" Caster Option:
Available on all Metal Legs ONLY, with exception of the Balloon leg and Metal Bases.

MODEL NUMBER **PRODUCT** **WIDTH** **DEPTH** **HEIGHT**



*Shown Above:
TB-8442-DSQ-M-D



*Rectangle Table Shape

	Rectangle Table, 84" Width, 36" Depth	84"	36"	29"
	DROPPED SQUARE Edge;			
	with WOOD Leg Option:	84"	36"	29"
TB-8436-DSQ-W-SQ	Square			
TB-8436-DSQ-W-SQR	Square Radius			
TB-8436-DSQ-W-SQT	Square Tapered			
TB-8436-DSQ-W-DT	Diameter Tapered			
TB-8436-DSQ-W-SR	Safari			
	with METAL Leg Option:	84"	36"	29"
TB-8436-DSQ-M-SQ	Square			
TB-8436-DSQ-M-SS	Square & Stem			
TB-8436-DSQ-M-D	Diameter			
TB-8436-DSQ-M-DS	Diameter & Stem			
TB-8436-DSQ-M-BO	Balloon			
TB-8436-DSQ-MC-SQ	Square with Casters			
TB-8436-DSQ-MC-SS	Square & Stem with Casters			
TB-8436-DSQ-MC-D	Diameter with Casters			
TB-8436-DSQ-MC-DS	Diameter & Stem with Casters			
TB-8436-DSQ-FL	Flip Leg (for Nesting Tables)			
TB-8436-DSQ-FD	Folding Leg			
	Rectangle Table, 84" Width, 42" Depth	84"	42"	29"
	DROPPED SQUARE Edge;			
	with WOOD Leg Option:	84"	42"	29"
TB-8442-DSQ-W-SQ	Square			
TB-8442-DSQ-W-SQR	Square Radius			
TB-8442-DSQ-W-SQT	Square Tapered			
TB-8442-DSQ-W-DT	Diameter Tapered			
TB-8442-DSQ-W-SR	Safari			
	with METAL Leg Option:	84"	42"	29"
TB-8442-DSQ-M-SQ	Square			
TB-8442-DSQ-M-SS	Square & Stem			
TB-8442-DSQ-M-D	Diameter			
TB-8442-DSQ-M-DS	Diameter & Stem			
TB-8442-DSQ-M-BO	Balloon			
TB-8442-DSQ-MC-SQ	Square with Casters			
TB-8442-DSQ-MC-SS	Square & Stem with Casters			
TB-8442-DSQ-MC-D	Diameter with Casters			
TB-8442-DSQ-MC-DS	Diameter & Stem with Casters			
TB-8442-DSQ-FL	Flip Leg (for Nesting Tables)			
TB-8442-DSQ-FD	Folding Leg			

PRICE **DESCRIPTION**

	Each Table Top is constructed using a 1 1/8" thick top with a Plastic Laminate top surface.
	All Metal legs are coated electrostatically with an epoxy powder coat paint.
	NOTES:
	* Table heights of 25" (children), 27" (youth), and 32" (wheelchair) are available by request.
	* Color of Metal Paint must be specified at the time of order.
	* Caster Leg options are recommended for Reading/Multipurpose Tables options and not meant to be used for stationary computer workstations.
	* For all tables with casters legs, only 2 legs will have casters, and the other legs will have levelers. This will create a "wheelbarrow" style of table which will ensure ease of mobility.
	* Color of the Caster Option must be specified at the time of order.
	* For the Flip OR Fold Leg option, one T-based leg comes with 2 hidden casters as shown in the image below.
	Edge Option:
	"DSQ" 3/4" Dropped Square Edge
	Metal Leg Options:
	"M-SQ" Square 2" "M-SS" Square Stem 2" "M-D" Diameter 2" "M-DS" Diameter Stem 2" "M-BO" Balloon 2 1/2" "FL" or "FD" Flip OR Fold Leg
	Wood Leg Options:
	"W-SQ" Square 2 3/8" "W-SQR" Square Radius 2 3/8" "W-SQT" Square Tapered 2 3/8" "W-DT" Diameter Tapered 2 3/8" "W-SR" Safari 2 3/8" "MC" Caster Option: Available on all Metal Legs ONLY, with exception of the Balloon leg and Metal Bases.
\$ 1,744	
\$ 1,744	
\$ 1,938	
\$ 2,100	
\$ 2,106	
\$ 1,663	
\$ 2,200	
\$ 1,663	
\$ 2,200	
\$ 1,794	
\$ 1,950	
\$ 2,475	
\$ 1,950	
\$ 2,475	
\$ 2,744	
\$ 2,744	
\$ 1,825	
\$ 1,825	
\$ 2,019	
\$ 2,181	
\$ 2,188	
\$ 1,744	
\$ 2,275	
\$ 1,744	
\$ 2,275	
\$ 1,875	
\$ 1,169	
\$ 2,556	
\$ 2,025	
\$ 2,556	
\$ 2,850	
\$ 2,850	

MODEL NUMBER

PRODUCT

WIDTH DEPTH HEIGHT

PRICE

DESCRIPTION



*Shown Above:
TB-8442-DSQ-M-D



*Rectangle Table Shape

MODEL NUMBER	PRODUCT	WIDTH	DEPTH	HEIGHT
	Rectangle Table, 84" Width, 48" Depth	84"	48"	29"
	DROPPED SQUARE Edge;			
	with WOOD Leg Option:	84"	48"	29"
TB-8448-DSQ-W-SQ	Square			
TB-8448-DSQ-W-SQR	Square Radius			
TB-8448-DSQ-W-SQT	Square Tapered			
TB-8448-DSQ-W-DT	Diameter Tapered			
TB-8448-DSQ-W-SR	Safari			
	with METAL Leg Option:	84"	48"	29"
TB-8448-DSQ-M-SQ	Square			
TB-8448-DSQ-M-SS	Square & Stem			
TB-8448-DSQ-M-D	Diameter			
TB-8448-DSQ-M-DS	Diameter & Stem			
TB-8448-DSQ-M-BO	Balloon			
TB-8448-DSQ-MC-SQ	Square with Casters			
TB-8448-DSQ-MC-SS	Square & Stem with Casters			
TB-8448-DSQ-MC-D	Diameter with Casters			
TB-8448-DSQ-MC-DS	Diameter & Stem with Casters			
TB-8448-DSQ-FL	Flip Leg (for Nesting Tables)			
TB-8448-DSQ-FD	Folding Leg			

Each Table Top is constructed using a 1 1/8" thick top with a Plastic Laminate top surface.

All Metal legs are coated electrostatically with an epoxy powder coat paint.

NOTES:

- * Table heights of 25" (children), 27" (youth), and 32" (wheelchair) are available by request.
- * Color of Metal Paint must be specified at the time of order.
- * Caster Leg options are recommended for Reading/Multipurpose Tables options and not meant to be used for stationary computer workstations.
- * For all tables with casters legs, only 2 legs will have casters, and the other legs will have levelers. This will create a "wheelbarrow" style of table which will ensure ease of mobility.
- * Color of the Caster Option must be specified at the time of order.
- * For the Flip OR Fold Leg option, one T-based leg comes with 2 hidden casters as shown in the image below.

\$ 1,906
\$ 1,906
\$ 2,100
\$ 2,256
\$ 2,269
\$ 1,825
\$ 2,356
\$ 1,825
\$ 2,356
\$ 1,956
\$ 2,106
\$ 2,638
\$ 2,106
\$ 2,638
\$ 2,931
\$ 2,931

Edge Option:



Metal Leg Options:

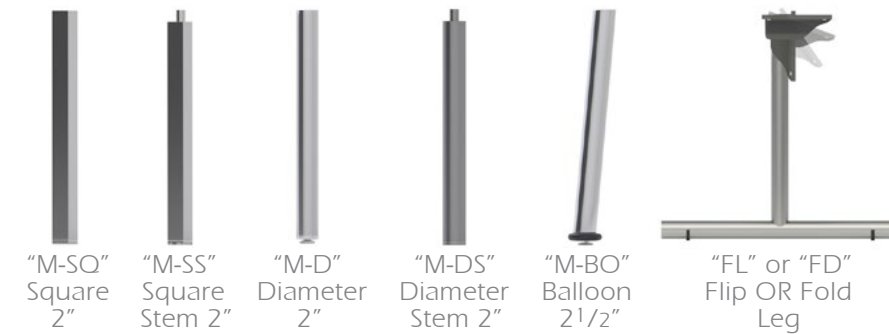

Wood Leg Options:

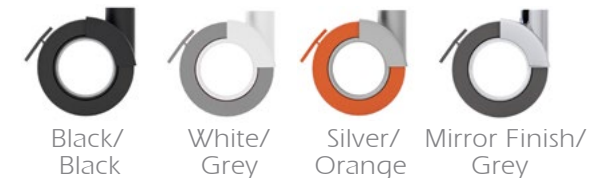
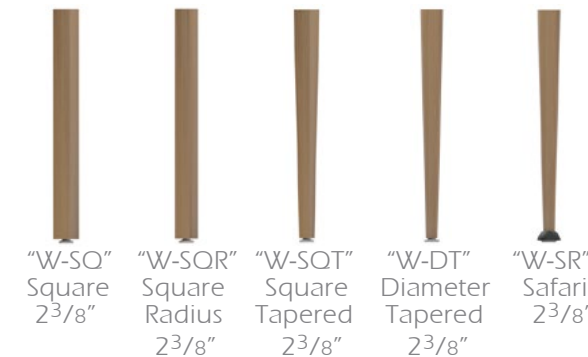

"MC" Caster Option:
Available on all Metal Legs ONLY, with exception of the Balloon leg and Metal Bases.

MODEL NUMBER

PRODUCT

WIDTH DEPTH HEIGHT

PRICE

DESCRIPTION



*Shown Above:
TB-8442-DBN-M-D



*Rectangle Table Shape

MODEL NUMBER	PRODUCT	WIDTH	DEPTH	HEIGHT	PRICE
	Rectangle Table, 84" Width, 36" Depth	84"	36"	29"	
	DROPPED BULLNOSE Edge;				
	with WOOD Leg Option:	84"	36"	29"	
TB-8436-DBN-W-SQ	Square				\$ 1,763
TB-8436-DBN-W-SQR	Square Radius				\$ 1,763
TB-8436-DBN-W-SQT	Square Tapered				\$ 1,950
TB-8436-DBN-W-DT	Diameter Tapered				\$ 2,113
TB-8436-DBN-W-SR	Safari				\$ 2,119
	with METAL Leg Option:	84"	36"	29"	
TB-8436-DBN-M-SQ	Square				\$ 1,681
TB-8436-DBN-M-SS	Square & Stem				\$ 2,213
TB-8436-DBN-M-D	Diameter				\$ 1,681
TB-8436-DBN-M-DS	Diameter & Stem				\$ 2,213
TB-8436-DBN-M-BO	Balloon				\$ 1,806
TB-8436-DBN-MC-SQ	Square with Casters				\$ 1,963
TB-8436-DBN-MC-SS	Square & Stem with Casters				\$ 2,494
TB-8436-DBN-MC-D	Diameter with Casters				\$ 1,963
TB-8436-DBN-MC-DS	Diameter & Stem with Casters				\$ 2,494
TB-8436-DBN-FL	Flip Leg (for Nesting Tables)				\$ 2,756
TB-8436-DBN-FD	Folding Leg				\$ 2,756
	Rectangle Table, 84" Width, 42" Depth	84"	42"	29"	
	DROPPED BULLNOSE Edge;				
	with WOOD Leg Option:	84"	42"	29"	
TB-8442-DBN-W-SQ	Square				\$ 1,844
TB-8442-DBN-W-SQR	Square Radius				\$ 1,844
TB-8442-DBN-W-SQT	Square Tapered				\$ 2,031
TB-8442-DBN-W-DT	Diameter Tapered				\$ 2,194
TB-8442-DBN-W-SR	Safari				\$ 2,200
	with METAL Leg Option:	84"	42"	29"	
TB-8442-DBN-M-SQ	Square				\$ 1,763
TB-8442-DBN-M-SS	Square & Stem				\$ 2,288
TB-8442-DBN-M-D	Diameter				\$ 1,763
TB-8442-DBN-M-DS	Diameter & Stem				\$ 2,288
TB-8442-DBN-M-BO	Balloon				\$ 1,888
TB-8442-DBN-MC-SQ	Square with Casters				\$ 2,044
TB-8442-DBN-MC-SS	Square & Stem with Casters				\$ 2,575
TB-8442-DBN-MC-D	Diameter with Casters				\$ 2,044
TB-8442-DBN-MC-DS	Diameter & Stem with Casters				\$ 2,575
TB-8442-DBN-FL	Flip Leg (for Nesting Tables)				\$ 2,869
TB-8442-DBN-FD	Folding Leg				\$ 2,869

Each Table Top is constructed using a 1 1/8" thick top with a Plastic Laminate top surface.

All Metal legs are coated electrostatically with an epoxy powder coat paint.

NOTES:

- * Table heights of 25" (children), 27" (youth), and 32" (wheelchair) are available by request.
- * Color of Metal Paint must be specified at the time of order.
- * Caster Leg options are recommended for Reading/Multipurpose Tables options and not meant to be used for stationary computer workstations.
- * For all tables with casters legs, only 2 legs will have casters, and the other legs will have levelers. This will create a "wheelbarrow" style of table which will ensure ease of mobility.
- * Color of the Caster Option must be specified at the time of order.
- * For the Flip OR Fold Leg option, one T-based leg comes with 2 hidden casters as shown in the

image below
Edge Option:



"DBN"
3/4" Dropped Bullnoses Edge

Metal Leg Options:

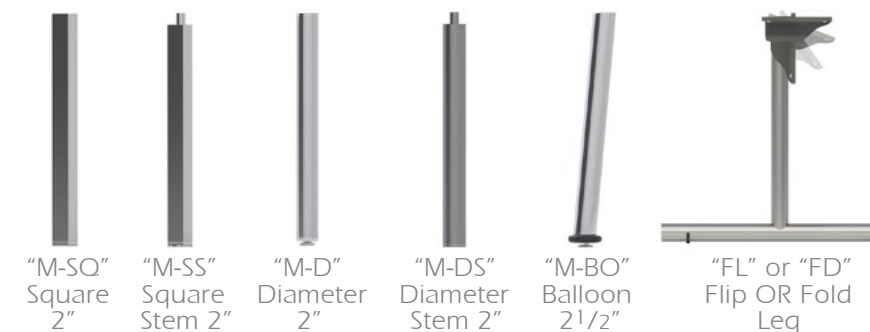

"M-SQ" Square 2"
"M-SS" Square Stem 2"
"M-D" Diameter 2"
"M-DS" Diameter Stem 2"
"M-BO" Balloon 2 1/2"
"FL" or "FD" Flip OR Fold Leg

Wood Leg Options:

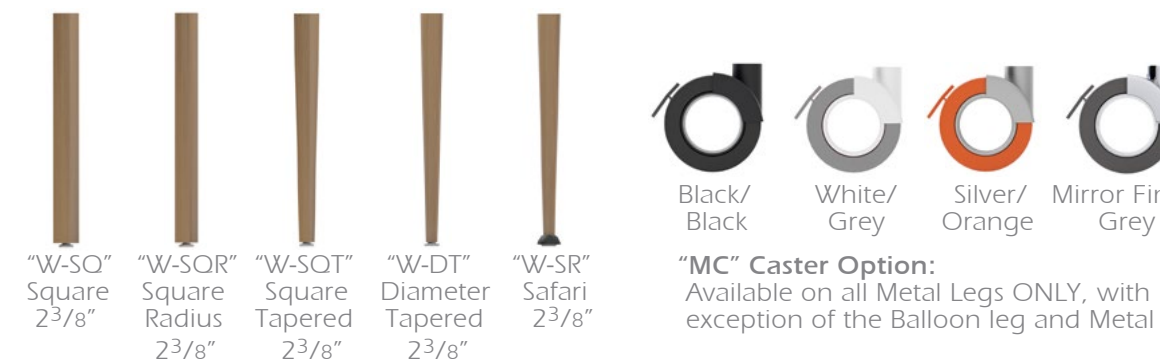

"W-SQ" Square 2 3/8"
"W-SQR" Square Radius 2 3/8"
"W-SQT" Square Tapered 2 3/8"
"W-DT" Diameter Tapered 2 3/8"
"W-SR" Safari 2 3/8"
"MC" Caster Option:
Available on all Metal Legs ONLY, with exception of the Balloon leg and Metal Bases.

MODEL NUMBER

PRODUCT

WIDTH DEPTH HEIGHT

PRICE

DESCRIPTION



*Shown Above:
TB-8442-DBN-M-D



*Rectangle Table Shape

MODEL NUMBER	PRODUCT	WIDTH	DEPTH	HEIGHT	PRICE
	Rectangle Table, 84" Width, 48" Depth	84"	48"	29"	
	DROPPED BULLNOSE Edge;				
	with WOOD Leg Option:	84"	48"	29"	
TB-8448-DBN-W-SQ	Square				\$ 1,925
TB-8448-DBN-W-SQR	Square Radius				\$ 1,925
TB-8448-DBN-W-SQT	Square Tapered				\$ 2,113
TB-8448-DBN-W-DT	Diameter Tapered				\$ 2,275
TB-8448-DBN-W-SR	Safari				\$ 2,281
	with METAL Leg Option:	84"	48"	29"	
TB-8448-DBN-M-SQ	Square				\$ 1,844
TB-8448-DBN-M-SS	Square & Stem				\$ 2,369
TB-8448-DBN-M-D	Diameter				\$ 1,844
TB-8448-DBN-M-DS	Diameter & Stem				\$ 2,369
TB-8448-DBN-M-BO	Balloon				\$ 1,969
TB-8448-DBN-MC-SQ	Square with Casters				\$ 2,119
TB-8448-DBN-MC-SS	Square & Stem with Casters				\$ 2,656
TB-8448-DBN-MC-D	Diameter with Casters				\$ 2,119
TB-8448-DBN-MC-DS	Diameter & Stem with Casters				\$ 2,656
TB-8448-DBN-FL	Flip Leg (for Nesting Tables)				\$ 2,950
TB-8448-DBN-FD	Folding Leg				\$ 2,950

Each Table Top is constructed using a 1 1/8" thick top with a Plastic Laminate top surface.

All Metal legs are coated electrostatically with an epoxy powder coat paint.

NOTES:

* Table heights of 25" (children), 27" (youth), and 32" (wheelchair) are available by request.

* Color of Metal Paint must be specified at the time of order.

* Caster Leg options are recommended for Reading/Multipurpose Tables options and not meant to be used for stationary computer workstations.

* For all tables with casters legs, only 2 legs will have casters, and the other legs will have levelers. This will create a "wheelbarrow" style of table which will ensure ease of mobility.

* Color of the Caster Option must be specified at the time of order.

* For the Flip OR Fold Leg option, one T-based leg comes with 2 hidden casters as shown in the

image below

Edge Option:



"DBN"
3/4" Dropped Bullnoses Edge

Metal Leg Options:



"M-SQ" Square 2"
"M-SS" Square Stem 2"
"M-D" Diameter 2"
"M-DS" Diameter Stem 2"
"M-BO" Balloon 2 1/2"
"FL" or "FD" Flip OR Fold Leg

Wood Leg Options:

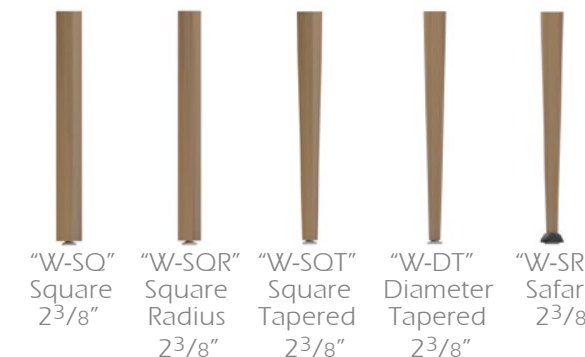

"W-SQ" Square 2 3/8"
"W-SQR" Square Radius 2 3/8"
"W-SQT" Square Tapered 2 3/8"
"W-DT" Diameter Tapered 2 3/8"
"W-SR" Safari 2 3/8"



Black/Black
White/Grey
Silver/Orange
Mirror Finish/Grey

"MC" Caster Option:
Available on all Metal Legs ONLY, with exception of the Balloon leg and Metal Bases.

MODEL NUMBER
PRODUCT
WIDTH DEPTH HEIGHT
PRICE
DESCRIPTION

*Shown Above:
TB-8442-DCH-M-D



*Rectangle Table Shape

MODEL NUMBER	PRODUCT	WIDTH	DEPTH	HEIGHT	PRICE
	Rectangle Table, 84" Width, 36" Depth	84"	36"	29"	
	DROPPED CHAMFERED Edge;				
	with WOOD Leg Option:	84"	36"	29"	
TB-8436-DCH-W-SQ	Square				\$ 1,763
TB-8436-DCH-W-SQR	Square Radius				\$ 1,763
TB-8436-DCH-W-SQT	Square Tapered				\$ 1,950
TB-8436-DCH-W-DT	Diameter Tapered				\$ 2,113
TB-8436-DCH-W-SR	Safari				\$ 2,119
	with METAL Leg Option:	84"	36"	29"	
TB-8436-DCH-M-SQ	Square				\$ 2,213
TB-8436-DCH-M-SS	Square & Stem				\$ 1,681
TB-8436-DCH-M-D	Diameter				\$ 2,213
TB-8436-DCH-M-DS	Diameter & Stem				\$ 2,213
TB-8436-DCH-M-BO	Balloon				\$ 1,806
TB-8436-DCH-MC-SQ	Square with Casters				\$ 1,963
TB-8436-DCH-MC-SS	Square & Stem with Casters				\$ 2,494
TB-8436-DCH-MC-D	Diameter with Casters				\$ 1,963
TB-8436-DCH-MC-DS	Diameter & Stem with Casters				\$ 2,494
TB-8436-DCH-FL	Flip Leg (for Nesting Tables)				\$ 2,756
TB-8436-DCH-FD	Folding Leg				\$ 2,756
	Rectangle Table, 84" Width, 42" Depth	84"	42"	29"	
	DROPPED CHAMFERED Edge;				
	with WOOD Leg Option:	84"	42"	29"	
TB-8442-DCH-W-SQ	Square				\$ 1,844
TB-8442-DCH-W-SQR	Square Radius				\$ 1,844
TB-8442-DCH-W-SQT	Square Tapered				\$ 2,031
TB-8442-DCH-W-DT	Diameter Tapered				\$ 2,194
TB-8442-DCH-W-SR	Safari				\$ 2,200
	with METAL Leg Option:	84"	42"	29"	
TB-8442-DCH-M-SQ	Square				\$ 1,763
TB-8442-DCH-M-SS	Square & Stem				\$ 2,288
TB-8442-DCH-M-D	Diameter				\$ 1,763
TB-8442-DCH-M-DS	Diameter & Stem				\$ 2,288
TB-8442-DCH-M-BO	Balloon				\$ 1,888
TB-8442-DCH-MC-SQ	Square with Casters				\$ 2,044
TB-8442-DCH-MC-SS	Square & Stem with Casters				\$ 2,575
TB-8442-DCH-MC-D	Diameter with Casters				\$ 2,044
TB-8442-DCH-MC-DS	Diameter & Stem with Casters				\$ 2,575
TB-8442-DCH-FL	Flip Leg (for Nesting Tables)				\$ 2,869
TB-8442-DCH-FD	Folding Leg				\$ 2,869

Each Table Top is constructed using a 1 1/8" thick top with a Plastic Laminate top surface.

All Metal legs are coated electrostatically with an epoxy powder coat paint.

NOTES:

- * Table heights of 25" (children), 27" (youth), and 32" (wheelchair) are available by request.
- * Color of Metal Paint must be specified at the time of order.
- * Caster Leg options are recommended for Reading/Multipurpose Tables options and not meant to be used for stationary computer workstations.
- * For all tables with casters legs, only 2 legs will have casters, and the other legs will have levelers. This will create a "wheelbarrow" style of table which will ensure ease of mobility.
- * Color of the Caster Option must be specified at the time of order.
- * For the Flip OR Fold Leg option, one T-based leg comes with 2 hidden casters as shown in the image below.

Edge Option:

"DCH"
3/4" Dropped Chamfered Edge

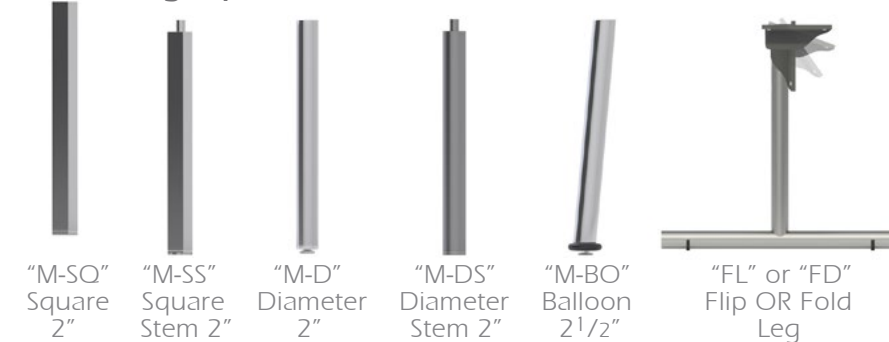
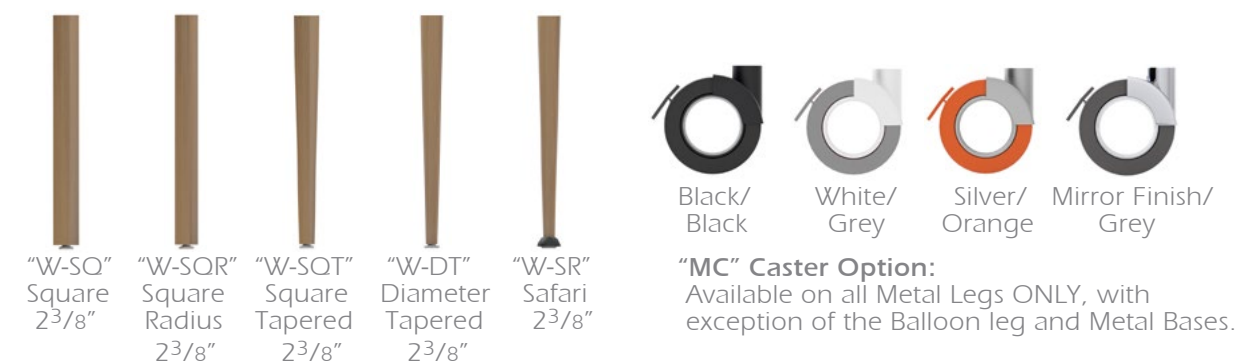
Metal Leg Options:

Wood Leg Options:

"MC" Caster Option:
Available on all Metal Legs ONLY, with exception of the Balloon leg and Metal Bases.

MODEL NUMBER

PRODUCT

WIDTH DEPTH HEIGHT

PRICE

DESCRIPTION



*Shown Above:
TB-8442-DCH-M-D



*Rectangle Table Shape

MODEL NUMBER	PRODUCT	WIDTH	DEPTH	HEIGHT	PRICE
	Rectangle Table, 84" Width, 48" Depth	84"	48"	29"	
	DROPPED CHAMFERED Edge;				
	with WOOD Leg Option:	84"	48"	29"	
TB-8448-DCH-W-SQ	Square				\$ 1,925
TB-8448-DCH-W-SQR	Square Radius				\$ 1,925
TB-8448-DCH-W-SQT	Square Tapered				\$ 2,113
TB-8448-DCH-W-DT	Diameter Tapered				\$ 2,275
TB-8448-DCH-W-SR	Safari				\$ 2,281
	with METAL Leg Option:	84"	48"	29"	
TB-8448-DCH-M-SQ	Square				\$ 1,844
TB-8448-DCH-M-SS	Square & Stem				\$ 2,369
TB-8448-DCH-M-D	Diameter				\$ 1,844
TB-8448-DCH-M-DS	Diameter & Stem				\$ 2,369
TB-8448-DCH-M-BO	Balloon				\$ 1,969
TB-8448-DCH-MC-SQ	Square with Casters				\$ 2,119
TB-8448-DCH-MC-SS	Square & Stem with Casters				\$ 2,656
TB-8448-DCH-MC-D	Diameter with Casters				\$ 2,119
TB-8448-DCH-MC-DS	Diameter & Stem with Casters				\$ 2,656
TB-8448-DCH-FL	Flip Leg (for Nesting Tables)				\$ 2,950
TB-8448-DCH-FD	Folding Leg				\$ 2,950

Each Table Top is constructed using a 1 1/8" thick top with a Plastic Laminate top surface.

All Metal legs are coated electrostatically with an epoxy powder coat paint.

NOTES:

- * Table heights of 25" (children), 27" (youth), and 32" (wheelchair) are available by request.
- * Color of Metal Paint must be specified at the time of order.
- * Caster Leg options are recommended for Reading/Multipurpose Tables options and not meant to be used for stationary computer workstations.
- * For all tables with casters legs, only 2 legs will have casters, and the other legs will have levelers. This will create a "wheelbarrow" style of table which will ensure ease of mobility.
- * Color of the Caster Option must be specified at the time of order.
- * For the Flip OR Fold Leg option, one T-based leg comes with 2 hidden casters as shown in the image below.

Edge Option:



"DCH"
3/4" Dropped Chamfered Edge

Metal Leg Options:

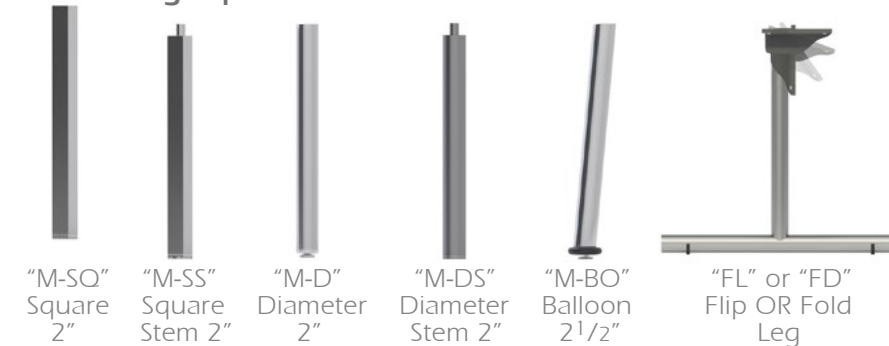

"M-SQ" Square 2"
"M-SS" Square Stem 2"
"M-D" Diameter 2"
"M-DS" Diameter Stem 2"
"M-BO" Balloon 2 1/2"
"FL" or "FD" Flip OR Fold Leg

Wood Leg Options:

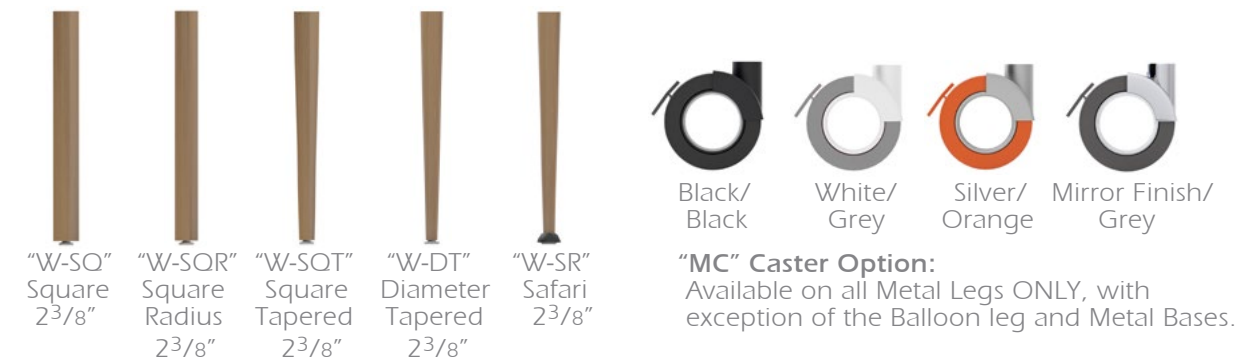

"W-SQ" Square 2 3/8"
"W-SQR" Square Radius 2 3/8"
"W-SQT" Square Tapered 2 3/8"
"W-DT" Diameter Tapered 2 3/8"
"W-SR" Safari 2 3/8"

Black/Black White/Grey Silver/Orange Mirror Finish/Grey

"MC" Caster Option:
Available on all Metal Legs ONLY, with exception of the Balloon leg and Metal Bases.

MODEL NUMBER
PRODUCT
WIDTH DEPTH HEIGHT
PRICE
DESCRIPTION

*Shown Above:
TB-8442-AL-M-D



*Rectangle Table Shape

MODEL NUMBER	PRODUCT	WIDTH	DEPTH	HEIGHT
	Rectangle Table, 84" Width, 36" Depth	84"	36"	29"
	ALUMINUM Edge;			
	with WOOD Leg Option:	84"	36"	29"
TB-8436-AL-W-SQ	Square			
TB-8436-AL-W-SQR	Square Radius			
TB-8436-AL-W-SQT	Square Tapered			
TB-8436-AL-W-DT	Diameter Tapered			
TB-8436-AL-W-SR	Safari			
	with METAL Leg Option:	84"	36"	29"
TB-8436-AL-M-SQ	Square			
TB-8436-AL-M-SS	Square & Stem			
TB-8436-AL-M-D	Diameter			
TB-8436-AL-M-DS	Diameter & Stem			
TB-8436-AL-M-BO	Balloon			
TB-8436-AL-MC-SQ	Square with Casters			
TB-8436-AL-MC-SS	Square & Stem with Casters			
TB-8436-AL-MC-D	Diameter with Casters			
TB-8436-AL-MC-DS	Diameter & Stem with Casters			
TB-8436-AL-FL	Flip Leg (for Nesting Tables)			
TB-8436-AL-FD	Folding Leg			
	Rectangle Table, 84" Width, 42" Depth	84"	42"	29"
	ALUMINUM Edge;			
	with WOOD Leg Option:	84"	42"	29"
TB-8442-AL-W-SQ	Square			
TB-8442-AL-W-SQR	Square Radius			
TB-8442-AL-W-SQT	Square Tapered			
TB-8442-AL-W-DT	Diameter Tapered			
TB-8442-AL-W-SR	Safari			
	with METAL Leg Option:	84"	42"	29"
TB-8442-AL-M-SQ	Square			
TB-8442-AL-M-SS	Square & Stem			
TB-8442-AL-M-D	Diameter			
TB-8442-AL-M-DS	Diameter & Stem			
TB-8442-AL-M-BO	Balloon			
TB-8442-AL-MC-SQ	Square with Casters			
TB-8442-AL-MC-SS	Square & Stem with Casters			
TB-8442-AL-MC-D	Diameter with Casters			
TB-8442-AL-MC-DS	Diameter & Stem with Casters			
TB-8442-AL-FL	Flip Leg (for Nesting Tables)			
TB-8442-AL-FD	Folding Leg			

Each Table Top is constructed using a 1 1/8" thick top with a Plastic Laminate top surface.

All Metal legs are coated electrostatically with an epoxy powder coat paint.

NOTES:

- * Table heights of 25" (children), 27" (youth), and 32" (wheelchair) are available by request.
- * Color of Metal Paint must be specified at the time of order.
- * Caster Leg options are recommended for Reading/Multipurpose Tables options and not meant to be used for stationary computer workstations.
- * For all tables with casters legs, only 2 legs will have casters, and the other legs will have levelers. This will create a "wheelbarrow" style of table which will ensure ease of mobility.
- * Color of the Caster Option must be specified at the time of order.
- * For the Flip OR Fold Leg option, one T-based leg comes with 2 hidden casters as shown in the image below.

\$ 1,525
\$ 1,525
\$ 1,713
\$ 1,875
\$ 1,881
\$ 1,444

\$ 1,975
\$ 1,444
\$ 1,975
\$ 1,569
\$ 1,725
\$ 2,256
\$ 1,725
\$ 2,256
\$ 2,519
\$ 2,519

Edge Option:

"AL"

3mm Aluminum Edge *All table corners will be given a 6-inch radius for this edge option.

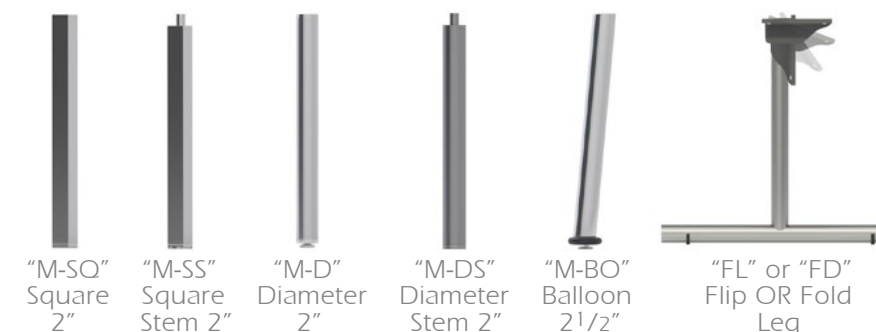
Metal Leg Options:

"M-SQ" Square 2"
"M-SS" Square Stem 2"
"M-D" Diameter 2"
"M-DS" Diameter Stem 2"
"M-BO" Balloon 2 1/2"
"FL" or "FD" Flip OR Fold Leg

Wood Leg Options:

"W-SQ" Square 2 3/8"
"W-SQR" Square Radius 2 3/8"
"W-SQT" Square Tapered 2 3/8"
"W-DT" Diameter Tapered 2 3/8"
"W-SR" Safari 2 3/8"



"MC" Caster Option:
Available on all Metal Legs ONLY, with exception of the Balloon leg and Metal Bases.

MODEL NUMBER

PRODUCT

WIDTH DEPTH HEIGHT

PRICE

DESCRIPTION



*Shown Above:
TB-8442-AL-M-D

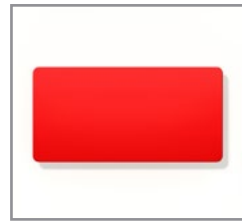

*Rectangle Table Shape

MODEL NUMBER	PRODUCT	WIDTH	DEPTH	HEIGHT	PRICE
	Rectangle Table, 84" Width, 48" Depth	84"	48"	29"	
	ALUMINUM Edge;				
	with WOOD Leg Option:	84"	48"	29"	
TB-8448-AL-W-SQ	Square				\$ 1,663
TB-8448-AL-W-SQR	Square Radius				\$ 1,663
TB-8448-AL-W-SQT	Square Tapered				\$ 1,850
TB-8448-AL-W-DT	Diameter Tapered				\$ 2,013
TB-8448-AL-W-SR	Safari				\$ 2,019
	with METAL Leg Option:	84"	48"	29"	
TB-8448-AL-M-SQ	Square				\$ 1,581
TB-8448-AL-M-SS	Square & Stem				\$ 2,106
TB-8448-AL-M-D	Diameter				\$ 1,581
TB-8448-AL-M-DS	Diameter & Stem				\$ 2,106
TB-8448-AL-M-BO	Balloon				\$ 1,706
TB-8448-AL-MC-SQ	Square with Casters				\$ 1,863
TB-8448-AL-MC-SS	Square & Stem with Casters				\$ 2,394
TB-8448-AL-MC-D	Diameter with Casters				\$ 1,863
TB-8448-AL-MC-DS	Diameter & Stem with Casters				\$ 2,394
TB-8448-AL-FL	Flip Leg (for Nesting Tables)				\$ 2,656
TB-8448-AL-FD	Folding Leg				\$ 2,656

Each Table Top is constructed using a 1 1/8" thick top with a Plastic Laminate top surface.

All Metal legs are coated electrostatically with an epoxy powder coat paint.

NOTES:

- * Table heights of 25" (children), 27" (youth), and 32" (wheelchair) are available by request.
- * Color of Metal Paint must be specified at the time of order.
- * Caster Leg options are recommended for Reading/Multipurpose Tables options and not meant to be used for stationary computer workstations.
- * For all tables with casters legs, only 2 legs will have casters, and the other legs will have levelers. This will create a "wheelbarrow" style of table which will ensure ease of mobility.
- * Color of the Caster Option must be specified at the time of order.
- * For the Flip OR Fold Leg option, one T-based leg comes with 2 hidden casters as shown in the image below.

Edge Option:



"AL"

3mm Aluminum Edge *All table corners will be given a 6-inch radius for this edge option.

Metal Leg Options:



"M-SQ" Square 2"
"M-SS" Square Stem 2"
"M-D" Diameter 2"
"M-DS" Diameter Stem 2"
"M-BO" Balloon 2 1/2"
"FL" or "FD" Flip OR Fold Leg

Wood Leg Options:

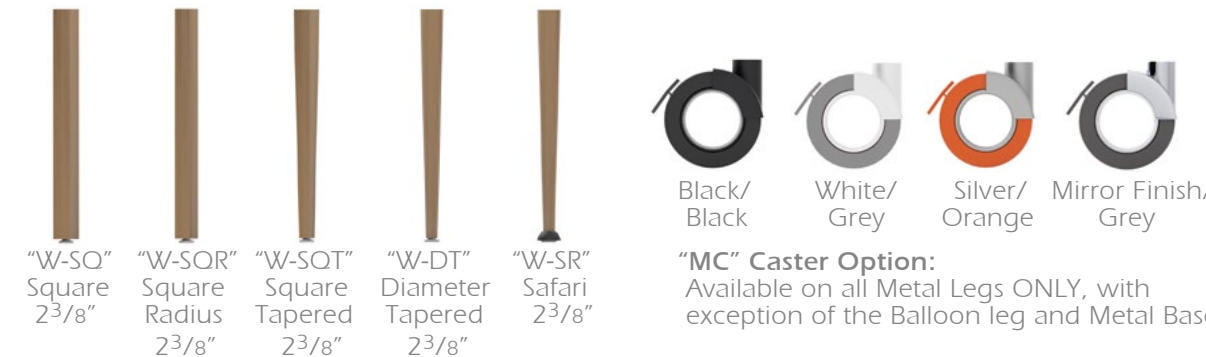

"W-SQ" Square 2 3/8"
"W-SQR" Square Radius 2 3/8"
"W-SQT" Square Tapered 2 3/8"
"W-DT" Diameter Tapered 2 3/8"
"W-SR" Safari 2 3/8"

Black/Black White/Grey Silver/Orange Mirror Finish/Grey

"MC" Caster Option:
Available on all Metal Legs ONLY, with exception of the Balloon leg and Metal Bases.

MODEL NUMBER

PRODUCT

WIDTH DEPTH HEIGHT

PRICE

DESCRIPTION



*Shown Above:
TB-9642-AC-M-D



*Rectangle Table Shape

MODEL NUMBER	PRODUCT	WIDTH	DEPTH	HEIGHT
	Rectangle Table, 96" Width, 36" Depth	96"	36"	29"
	ACRYLIC Edge;			
	with WOOD Leg Option:	96"	36"	29"
TB-9636-AC-W-SQ	Square			
TB-9636-AC-W-SQR	Square Radius			
TB-9636-AC-W-SQT	Square Tapered			
TB-9636-AC-W-DT	Diameter Tapered			
TB-9636-AC-W-SR	Safari			
	with METAL Leg Option:	96"	36"	29"
TB-9636-AC-M-SQ	Square			
TB-9636-AC-M-SS	Square & Stem			
TB-9636-AC-M-D	Diameter			
TB-9636-AC-M-DS	Diameter & Stem			
TB-9636-AC-M-BO	Balloon			
TB-9636-AC-MC-SQ	Square with Casters			
TB-9636-AC-MC-SS	Square & Stem with Casters			
TB-9636-AC-MC-D	Diameter with Casters			
TB-9636-AC-MC-DS	Diameter & Stem with Casters			
TB-9636-AC-FL	Flip Leg (for Nesting Tables)			
TB-9636-AC-FD	Folding Leg			
	Rectangle Table, 96" Width, 42" Depth	96"	42"	29"
	ACRYLIC Edge;			
	with WOOD Leg Option:	96"	42"	29"
TB-9642-AC-W-SQ	Square			
TB-9642-AC-W-SQR	Square Radius			
TB-9642-AC-W-SQT	Square Tapered			
TB-9642-AC-W-DT	Diameter Tapered			
TB-9642-AC-W-SR	Safari			
	with METAL Leg Option:	96"	42"	29"
TB-9642-AC-M-SQ	Square			
TB-9642-AC-M-SS	Square & Stem			
TB-9642-AC-M-D	Diameter			
TB-9642-AC-M-DS	Diameter & Stem			
TB-9642-AC-M-BO	Balloon			
TB-9642-AC-MC-SQ	Square with Casters			
TB-9642-AC-MC-SS	Square & Stem with Casters			
TB-9642-AC-MC-D	Diameter with Casters			
TB-9642-AC-MC-DS	Diameter & Stem with Casters			
TB-9642-AC-FL	Flip Leg (for Nesting Tables)			
TB-9642-AC-FD	Folding Leg			

\$ 1,438
\$ 1,438
\$ 1,625
\$ 1,788
\$ 1,800

\$ 1,356
\$ 1,881
\$ 1,356
\$ 1,881
\$ 1,488
\$ 1,638
\$ 2,169
\$ 1,638
\$ 2,169
\$ 2,438
\$ 2,438

\$ 1,506
\$ 1,506
\$ 1,694
\$ 1,856
\$ 1,863

\$ 1,425
\$ 1,956
\$ 1,425
\$ 1,956
\$ 1,550
\$ 1,706
\$ 2,238
\$ 1,706
\$ 2,238
\$ 2,531
\$ 2,531

Each Table Top is constructed using a 1" thick top with a Plastic Laminate top surface.

All Metal legs are coated electrostatically with an epoxy powder coat paint.

NOTES:

- * Table heights of 25" (children), 27" (youth), and 32" (wheelchair) are available by request.
- * Color of Metal Paint must be specified at the time of order.
- * Caster Leg options are recommended for Reading/Multipurpose Tables options and not meant to be used for stationary computer workstations.
- * For all tables with casters legs, only 2 legs will have casters, and the other legs will have levelers. This will create a "wheelbarrow" style of table which will ensure ease of mobility.
- * Color of the Caster Option must be specified at the time of order.
- * For the Flip OR Fold Leg option, one T-based leg comes with 2 hidden casters as shown in the image below.

Edge Option:

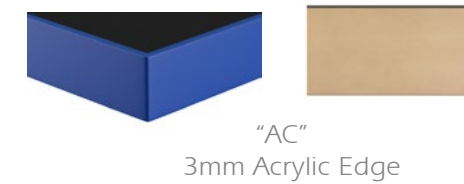

Metal Leg Options:

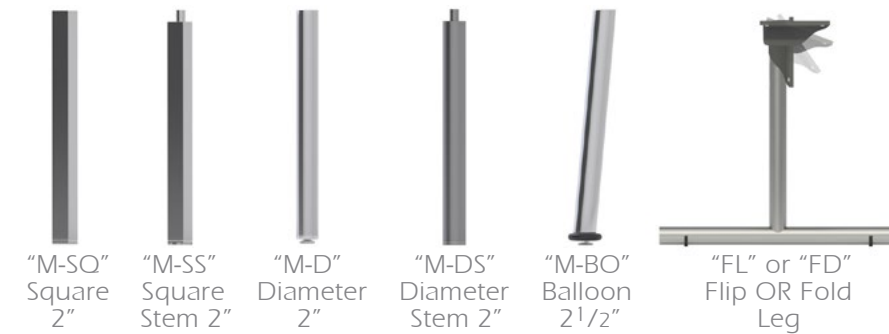

Wood Leg Options:

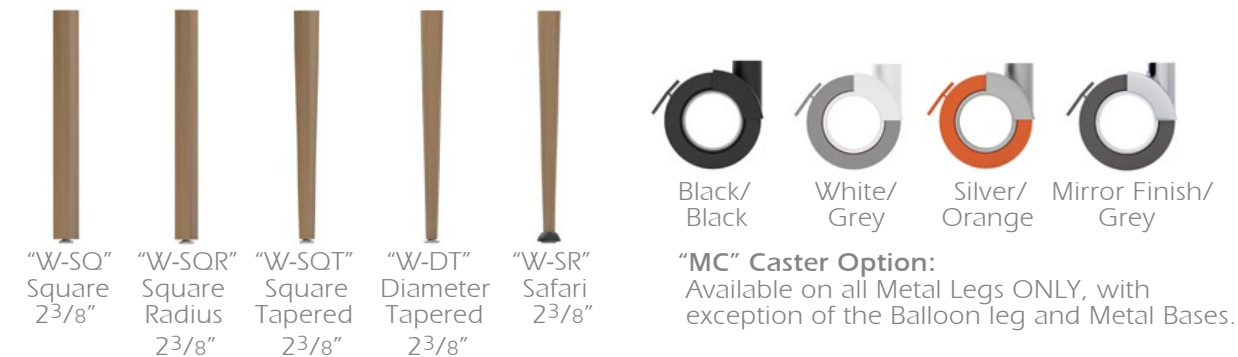

MODEL NUMBER

PRODUCT

WIDTH DEPTH HEIGHT

PRICE

DESCRIPTION



*Shown Above:
TB-9642-AC-M-D



*Rectangle Table Shape

MODEL NUMBER	PRODUCT	WIDTH	DEPTH	HEIGHT
	Rectangle Table, 96" Width, 48" Depth	96"	48"	29"
	ACRYLIC Edge;			
	with WOOD Leg Option:	96"	48"	29"
TB-9648-AC-W-SQ	Square			
TB-9648-AC-W-SQR	Square Radius			
TB-9648-AC-W-SQT	Square Tapered			
TB-9648-AC-W-DT	Diameter Tapered			
TB-9648-AC-W-SR	Safari			
	with METAL Leg Option:	96"	48"	29"
TB-9648-AC-M-SQ	Square			
TB-9648-AC-M-SS	Square & Stem			
TB-9648-AC-M-D	Diameter			
TB-9648-AC-M-DS	Diameter & Stem			
TB-9648-AC-M-BO	Balloon			
TB-9648-AC-MC-SQ	Square with Casters			
TB-9648-AC-MC-SS	Square & Stem with Casters			
TB-9648-AC-MC-D	Diameter with Casters			
TB-9648-AC-MC-DS	Diameter & Stem with Casters			
TB-9648-AC-FL	Flip Leg (for Nesting Tables)			
TB-9648-AC-FD	Folding Leg			

Each Table Top is constructed using a 1" thick top with a Plastic Laminate top surface.

All Metal legs are coated electrostatically with an epoxy powder coat paint.

NOTES:

- * Table heights of 25" (children), 27" (youth), and 32" (wheelchair) are available by request.
- * Color of Metal Paint must be specified at the time of order.
- * Caster Leg options are recommended for Reading/Multipurpose Tables options and not meant to be used for stationary computer workstations.
- * For all tables with casters legs, only 2 legs will have casters, and the other legs will have levelers. This will create a "wheelbarrow" style of table which will ensure ease of mobility.
- * Color of the Caster Option must be specified at the time of order.
- * For the Flip OR Fold Leg option, one T-based leg comes with 2 hidden casters as shown in the image below.

\$ 1,669
\$ 1,669
\$ 1,863
\$ 2,019
\$ 2,031

\$ 1,588
\$ 2,119
\$ 1,588
\$ 2,119
\$ 1,719
\$ 1,869
\$ 2,400
\$ 1,869
\$ 2,400
\$ 2,600
\$ 2,600

Edge Option:

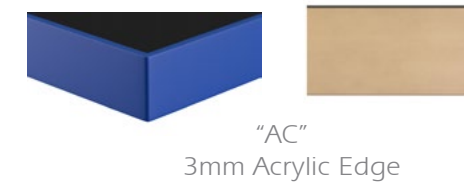

Metal Leg Options:

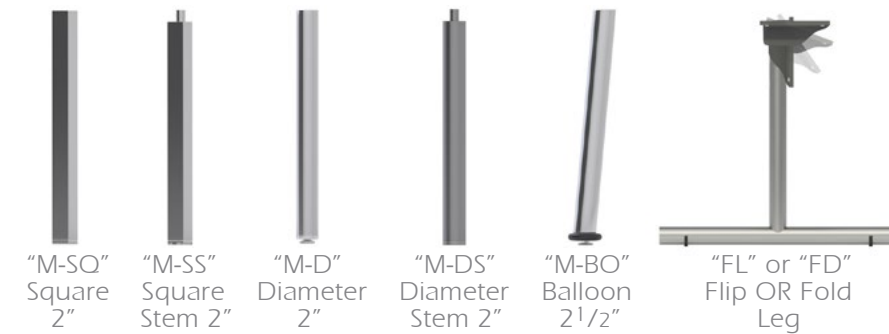

Wood Leg Options:

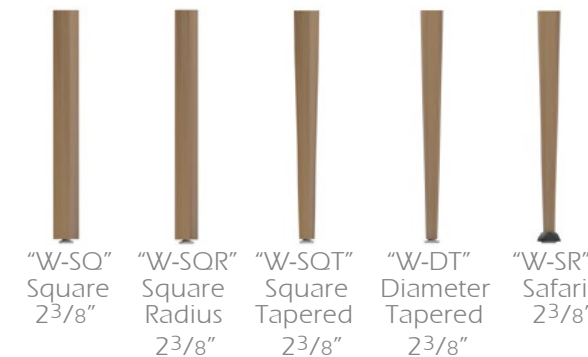

"MC" Caster Option:
Available on all Metal Legs ONLY, with exception of the Balloon leg and Metal Bases.

MODEL NUMBER

PRODUCT

WIDTH DEPTH HEIGHT

PRICE

DESCRIPTION



*Shown Above:
TB-9642-SQ-M-D



*Rectangle Table Shape

MODEL NUMBER	PRODUCT	WIDTH	DEPTH	HEIGHT	PRICE
	Rectangle Table, 96" Width, 36" Depth	96"	36"	29"	
	SQUARE Edge;				
	with WOOD Leg Option:	96"	36"	29"	
TB-9636-SQ-W-SQ	Square				\$ 1,700
TB-9636-SQ-W-SQR	Square Radius				\$ 1,700
TB-9636-SQ-W-SQT	Square Tapered				\$ 1,888
TB-9636-SQ-W-DT	Diameter Tapered				\$ 2,050
TB-9636-SQ-W-SR	Safari				\$ 2,063
	with METAL Leg Option:	96"	36"	29"	
TB-9636-SQ-M-SQ	Square				\$ 1,619
TB-9636-SQ-M-SS	Square & Stem				\$ 2,144
TB-9636-SQ-M-D	Diameter				\$ 1,619
TB-9636-SQ-M-DS	Diameter & Stem				\$ 2,144
TB-9636-SQ-M-BO	Balloon				\$ 1,744
TB-9636-SQ-MC-SQ	Square with Casters				\$ 1,900
TB-9636-SQ-MC-SS	Square & Stem with Casters				\$ 2,431
TB-9636-SQ-MC-D	Diameter with Casters				\$ 1,900
TB-9636-SQ-MC-DS	Diameter & Stem with Casters				\$ 2,431
TB-9636-SQ-FL	Flip Leg (for Nesting Tables)				\$ 2,694
TB-9636-SQ-FD	Folding Leg				\$ 2,694
	Rectangle Table, 96" Width, 42" Depth	96"	42"	29"	
	SQUARE Edge;				
	with WOOD Leg Option:	96"	42"	29"	
TB-9642-SQ-W-SQ	Square				\$ 1,956
TB-9642-SQ-W-SQR	Square Radius				\$ 1,956
TB-9642-SQ-W-SQT	Square Tapered				\$ 2,144
TB-9642-SQ-W-DT	Diameter Tapered				\$ 2,306
TB-9642-SQ-W-SR	Safari				\$ 2,319
	with METAL Leg Option:	96"	42"	29"	
TB-9642-SQ-M-SQ	Square				\$ 1,875
TB-9642-SQ-M-SS	Square & Stem				\$ 2,406
TB-9642-SQ-M-D	Diameter				\$ 1,875
TB-9642-SQ-M-DS	Diameter & Stem				\$ 2,406
TB-9642-SQ-M-BO	Balloon				\$ 2,000
TB-9642-SQ-MC-SQ	Square with Casters				\$ 2,163
TB-9642-SQ-MC-SS	Square & Stem with Casters				\$ 2,688
TB-9642-SQ-MC-D	Diameter with Casters				\$ 2,163
TB-9642-SQ-MC-DS	Diameter & Stem with Casters				\$ 2,688
TB-9642-SQ-FL	Flip Leg (for Nesting Tables)				\$ 2,981
TB-9642-SQ-FD	Folding Leg				\$ 2,981

Each Table Top is constructed using a 1 1/8" thick top with a Plastic Laminate top surface.

All Metal legs are coated electrostatically with an epoxy powder coat paint.

NOTES:

- * Table heights of 25" (children), 27" (youth), and 32" (wheelchair) are available by request.
- * Color of Metal Paint must be specified at the time of order.
- * Caster Leg options are recommended for Reading/Multipurpose Tables options and not meant to be used for stationary computer workstations.
- * For all tables with casters legs, only 2 legs will have casters, and the other legs will have levelers. This will create a "wheelbarrow" style of table which will ensure ease of mobility.
- * Color of the Caster Option must be specified at the time of order.
- * For the Flip OR Fold Leg option, one T-based leg comes with 2 hidden casters as shown in the image below.

Edge Option:



"SQ"
1/4" Square Edge

Metal Leg Options:



"M-SQ" Square 2"
"M-SS" Square Stem 2"
"M-D" Diameter 2"
"M-DS" Diameter Stem 2"
"M-BO" Balloon 2 1/2"
"FL" or "FD" Flip OR Fold Leg

Wood Leg Options:

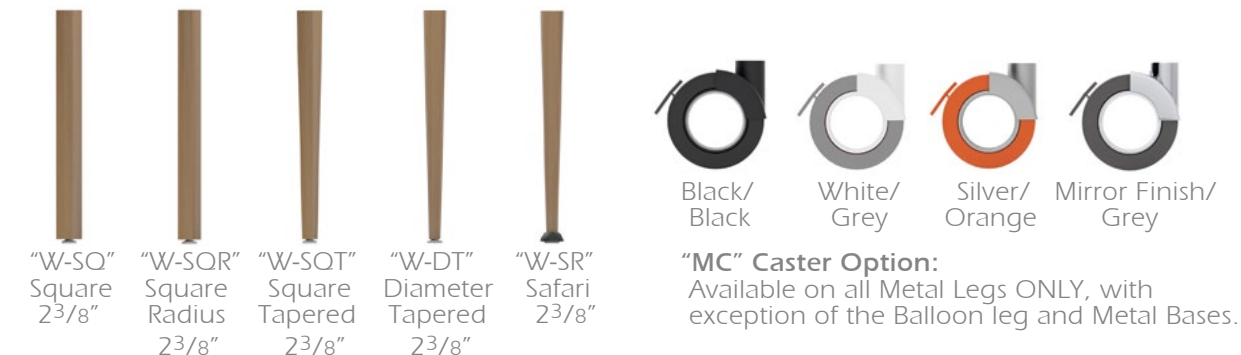

"W-SQ" Square 2 3/8"
"W-SQR" Square Radius 2 3/8"
"W-SQT" Square Tapered 2 3/8"
"W-DT" Diameter Tapered 2 3/8"
"W-SR" Safari 2 3/8"

"MC" Caster Option:
Available on all Metal Legs ONLY, with exception of the Balloon leg and Metal Bases.

MODEL NUMBER

PRODUCT

WIDTH DEPTH HEIGHT

PRICE

DESCRIPTION



*Shown Above:
TB-9642-SQ-M-D



*Rectangle Table Shape

MODEL NUMBER	PRODUCT	WIDTH	DEPTH	HEIGHT	PRICE
	Rectangle Table, 96" Width, 48" Depth	96"	48"	29"	
	SQUARE Edge;				
	with WOOD Leg Option:	96"	48"	29"	
TB-9648-SQ-W-SQ	Square				\$ 2,038
TB-9648-SQ-W-SQR	Square Radius				\$ 2,038
TB-9648-SQ-W-SQT	Square Tapered				\$ 2,225
TB-9648-SQ-W-DT	Diameter Tapered				\$ 2,388
TB-9648-SQ-W-SR	Safari				\$ 2,400
	with METAL Leg Option:	96"	48"	29"	
TB-9648-SQ-M-SQ	Square				\$ 1,956
TB-9648-SQ-M-SS	Square & Stem				\$ 2,488
TB-9648-SQ-M-D	Diameter				\$ 1,956
TB-9648-SQ-M-DS	Diameter & Stem				\$ 2,488
TB-9648-SQ-M-BO	Balloon				\$ 2,081
TB-9648-SQ-MC-SQ	Square with Casters				\$ 2,238
TB-9648-SQ-MC-SS	Square & Stem with Casters				\$ 2,769
TB-9648-SQ-MC-D	Diameter with Casters				\$ 2,238
TB-9648-SQ-MC-DS	Diameter & Stem with Casters				\$ 2,769
TB-9648-SQ-FL	Flip Leg (for Nesting Tables)				\$ 3,063
TB-9648-SQ-FD	Folding Leg				\$ 3,063

Each Table Top is constructed using a 1 1/8" thick top with a Plastic Laminate top surface.

All Metal legs are coated electrostatically with an epoxy powder coat paint.

NOTES:

- * Table heights of 25" (children), 27" (youth), and 32" (wheelchair) are available by request.
- * Color of Metal Paint must be specified at the time of order.
- * Caster Leg options are recommended for Reading/Multipurpose Tables options and not meant to be used for stationary computer workstations.
- * For all tables with casters legs, only 2 legs will have casters, and the other legs will have levelers. This will create a "wheelbarrow" style of table which will ensure ease of mobility.
- * Color of the Caster Option must be specified at the time of order.
- * For the Flip OR Fold Leg option, one T-based leg comes with 2 hidden casters as shown in the image below.

Edge Option:



"SQ"
1/4" Square Edge

Metal Leg Options:



"M-SQ" Square 2"
"M-SS" Square Stem 2"
"M-D" Diameter 2"
"M-DS" Diameter Stem 2"
"M-BO" Balloon 2 1/2"
"FL" or "FD" Flip OR Fold Leg

Wood Leg Options:

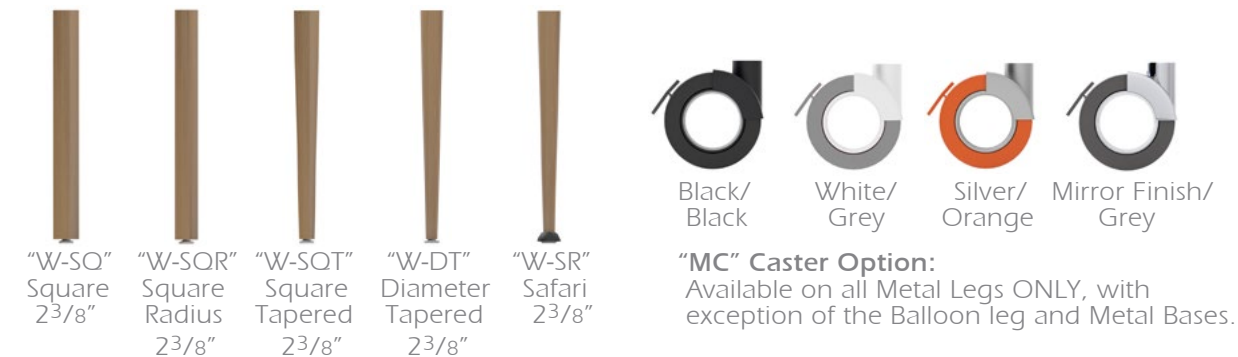

"W-SQ" Square 2 3/8"
"W-SQR" Square Radius 2 3/8"
"W-SQT" Square Tapered 2 3/8"
"W-DT" Diameter Tapered 2 3/8"
"W-SR" Safari 2 3/8"

Black/Black
White/Grey
Silver/Orange
Mirror Finish/Grey
"MC" Caster Option:
Available on all Metal Legs ONLY, with exception of the Balloon leg and Metal Bases.

MODEL NUMBER **PRODUCT** **WIDTH** **DEPTH** **HEIGHT**



*Shown Above:
TB-9642-DSQ-M-D



*Rectangle Table Shape

	Rectangle Table, 96" Width, 36" Depth	96"	36"	29"
	DROPPED SQUARE Edge;			
	with WOOD Leg Option:	96"	36"	29"
TB-9636-DSQ-W-SQ	Square			
TB-9636-DSQ-W-SQR	Square Radius			
TB-9636-DSQ-W-SQT	Square Tapered			
TB-9636-DSQ-W-DT	Diameter Tapered			
TB-9636-DSQ-W-SR	Safari			
	with METAL Leg Option:	96"	36"	29"
TB-9636-DSQ-M-SQ	Square			
TB-9636-DSQ-M-SS	Square & Stem			
TB-9636-DSQ-M-D	Diameter			
TB-9636-DSQ-M-DS	Diameter & Stem			
TB-9636-DSQ-M-BO	Balloon			
TB-9636-DSQ-MC-SQ	Square with Casters			
TB-9636-DSQ-MC-SS	Square & Stem with Casters			
TB-9636-DSQ-MC-D	Diameter with Casters			
TB-9636-DSQ-MC-DS	Diameter & Stem with Casters			
TB-9636-DSQ-FL	Flip Leg (for Nesting Tables)			
TB-9636-DSQ-FD	Folding Leg			
	Rectangle Table, 96" Width, 42" Depth	96"	42"	29"
	DROPPED SQUARE Edge;			
	with WOOD Leg Option:	96"	42"	29"
TB-9642-DSQ-W-SQ	Square			
TB-9642-DSQ-W-SQR	Square Radius			
TB-9642-DSQ-W-SQT	Square Tapered			
TB-9642-DSQ-W-DT	Diameter Tapered			
TB-9642-DSQ-W-SR	Safari			
	with METAL Leg Option:	96"	42"	29"
TB-9642-DSQ-M-SQ	Square			
TB-9642-DSQ-M-SS	Square & Stem			
TB-9642-DSQ-M-D	Diameter			
TB-9642-DSQ-M-DS	Diameter & Stem			
TB-9642-DSQ-M-BO	Balloon			
TB-9642-DSQ-MC-SQ	Square with Casters			
TB-9642-DSQ-MC-SS	Square & Stem with Casters			
TB-9642-DSQ-MC-D	Diameter with Casters			
TB-9642-DSQ-MC-DS	Diameter & Stem with Casters			
TB-9642-DSQ-FL	Flip Leg (for Nesting Tables)			
TB-9642-DSQ-FD	Folding Leg			

PRICE **DESCRIPTION**

	Each Table Top is constructed using a 1 1/8" thick top with a Plastic Laminate top surface.
	All Metal legs are coated electrostatically with an epoxy powder coat paint.
	NOTES:
	* Table heights of 25" (children), 27" (youth), and 32" (wheelchair) are available by request.
	* Color of Metal Paint must be specified at the time of order.
	* Caster Leg options are recommended for Reading/Multipurpose Tables options and not meant to be used for stationary computer workstations.
	* For all tables with casters legs, only 2 legs will have casters, and the other legs will have levelers. This will create a "wheelbarrow" style of table which will ensure ease of mobility.
	* Color of the Caster Option must be specified at the time of order.
	* For the Flip OR Fold Leg option, one T-based leg comes with 2 hidden casters as shown in the image below.
	Edge Option:
	"DSQ" 3/4" Dropped Square Edge
	Metal Leg Options:
	"M-SQ" Square 2" "M-SS" Square Stem 2" "M-D" Diameter 2" "M-DS" Diameter Stem 2" "M-BO" Balloon 2 1/2" "FL" or "FD" Flip OR Fold Leg
	Wood Leg Options:
	"W-SQ" Square 2 3/8" "W-SQR" Square Radius 2 3/8" "W-SQT" Square Tapered 2 3/8" "W-DT" Diameter Tapered 2 3/8" "W-SR" Safari 2 3/8" "MC" Caster Option: Available on all Metal Legs ONLY, with exception of the Balloon leg and Metal Bases.
\$ 1,844	
\$ 1,844	
\$ 2,031	
\$ 2,194	
\$ 2,200	
\$ 1,763	
\$ 2,288	
\$ 1,763	
\$ 2,288	
\$ 1,888	
\$ 2,044	
\$ 2,575	
\$ 2,044	
\$ 2,575	
\$ 2,838	
\$ 2,838	
\$ 2,106	
\$ 2,106	
\$ 2,300	
\$ 2,456	
\$ 2,463	
\$ 2,025	
\$ 2,556	
\$ 2,025	
\$ 2,556	
\$ 2,156	
\$ 2,306	
\$ 2,838	
\$ 2,306	
\$ 2,838	
\$ 3,131	
\$ 3,131	

MODEL NUMBER

PRODUCT

WIDTH DEPTH HEIGHT

PRICE

DESCRIPTION



*Shown Above:
TB-9642-DSQ-M-D



*Rectangle Table Shape

MODEL NUMBER	PRODUCT	WIDTH	DEPTH	HEIGHT	PRICE
	Rectangle Table, 96" Width, 48" Depth	96"	48"	29"	
	DROPPED SQUARE Edge;				
	with WOOD Leg Option:	96"	48"	29"	
TB-9648-DSQ-W-SQ	Square				\$ 2,194
TB-9648-DSQ-W-SQR	Square Radius				\$ 2,194
TB-9648-DSQ-W-SQT	Square Tapered				\$ 2,381
TB-9648-DSQ-W-DT	Diameter Tapered				\$ 2,544
TB-9648-DSQ-W-SR	Safari				\$ 1,700
	with METAL Leg Option:	96"	48"	29"	
TB-9648-DSQ-M-SQ	Square				\$ 2,113
TB-9648-DSQ-M-SS	Square & Stem				\$ 2,644
TB-9648-DSQ-M-D	Diameter				\$ 2,113
TB-9648-DSQ-M-DS	Diameter & Stem				\$ 2,644
TB-9648-DSQ-M-BO	Balloon				\$ 2,238
TB-9648-DSQ-MC-SQ	Square with Casters				\$ 2,400
TB-9648-DSQ-MC-SS	Square & Stem with Casters				\$ 2,925
TB-9648-DSQ-MC-D	Diameter with Casters				\$ 2,400
TB-9648-DSQ-MC-DS	Diameter & Stem with Casters				\$ 2,925
TB-9648-DSQ-FL	Flip Leg (for Nesting Tables)				\$ 3,219
TB-9648-DSQ-FD	Folding Leg				\$ 3,219

Each Table Top is constructed using a 1 1/8" thick top with a Plastic Laminate top surface.

All Metal legs are coated electrostatically with an epoxy powder coat paint.

NOTES:

- * Table heights of 25" (children), 27" (youth), and 32" (wheelchair) are available by request.
- * Color of Metal Paint must be specified at the time of order.
- * Caster Leg options are recommended for Reading/Multipurpose Tables options and not meant to be used for stationary computer workstations.
- * For all tables with casters legs, only 2 legs will have casters, and the other legs will have levelers. This will create a "wheelbarrow" style of table which will ensure ease of mobility.
- * Color of the Caster Option must be specified at the time of order.
- * For the Flip OR Fold Leg option, one T-based leg comes with 2 hidden casters as shown in the image below.

Edge Option:



Metal Leg Options:

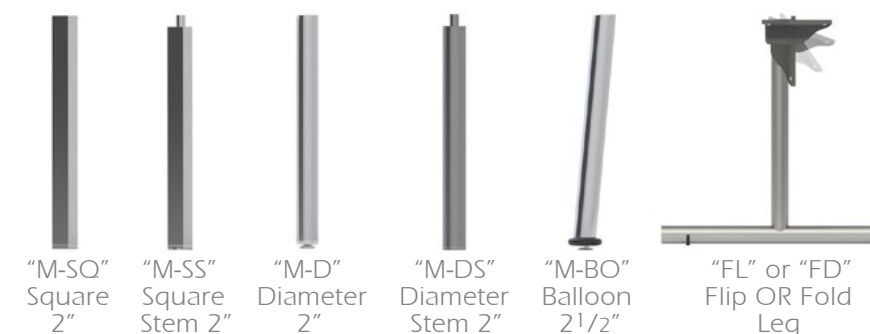

Wood Leg Options:

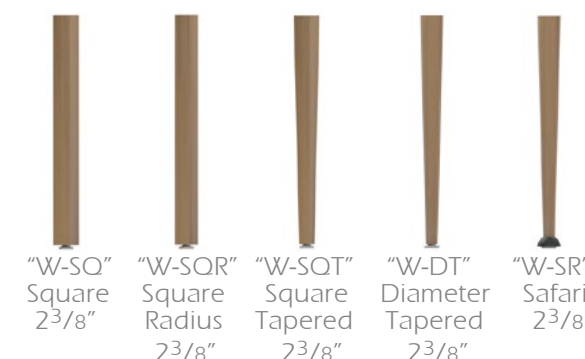

"MC" Caster Option:
Available on all Metal Legs ONLY, with exception of the Balloon leg and Metal Bases.

MODEL NUMBER

PRODUCT

WIDTH DEPTH HEIGHT

PRICE

DESCRIPTION



*Shown Above:
TB-9642-DBN-M-D



*Rectangle Table Shape

MODEL NUMBER	PRODUCT	WIDTH	DEPTH	HEIGHT	PRICE
	Rectangle Table, 96" Width, 36" Depth	96"	36"	29"	
	DROPPED BULLNOSE Edge;				
	with WOOD Leg Option:	96"	36"	29"	
TB-9636-DBN-W-SQ	Square				\$ 1,856
TB-9636-DBN-W-SQR	Square Radius				\$ 1,856
TB-9636-DBN-W-SQT	Square Tapered				\$ 2,044
TB-9636-DBN-W-DT	Diameter Tapered				\$ 2,206
TB-9636-DBN-W-SR	Safari				\$ 2,219
	with METAL Leg Option:	96"	36"	29"	
TB-9636-DBN-M-SQ	Square				\$ 1,775
TB-9636-DBN-M-SS	Square & Stem				\$ 2,300
TB-9636-DBN-M-D	Diameter				\$ 1,775
TB-9636-DBN-M-DS	Diameter & Stem				\$ 2,300
TB-9636-DBN-M-BO	Balloon				\$ 1,900
TB-9636-DBN-MC-SQ	Square with Casters				\$ 2,056
TB-9636-DBN-MC-SS	Square & Stem with Casters				\$ 2,588
TB-9636-DBN-MC-D	Diameter with Casters				\$ 2,056
TB-9636-DBN-MC-DS	Diameter & Stem with Casters				\$ 2,588
TB-9636-DBN-FL	Flip Leg (for Nesting Tables)				\$ 2,850
TB-9636-DBN-FD	Folding Leg				\$ 2,850
	Rectangle Table, 96" Width, 42" Depth	96"	42"	29"	
	DROPPED BULLNOSE Edge;				
	with WOOD Leg Option:	96"	42"	29"	
TB-9642-DBN-W-SQ	Square				\$ 2,119
TB-9642-DBN-W-SQR	Square Radius				\$ 2,119
TB-9642-DBN-W-SQT	Square Tapered				\$ 2,313
TB-9642-DBN-W-DT	Diameter Tapered				\$ 2,475
TB-9642-DBN-W-SR	Safari				\$ 2,481
	with METAL Leg Option:	96"	42"	29"	
TB-9642-DBN-M-SQ	Square				\$ 2,044
TB-9642-DBN-M-SS	Square & Stem				\$ 2,569
TB-9642-DBN-M-D	Diameter				\$ 2,044
TB-9642-DBN-M-DS	Diameter & Stem				\$ 2,569
TB-9642-DBN-M-BO	Balloon				\$ 2,169
TB-9642-DBN-MC-SQ	Square with Casters				\$ 2,319
TB-9642-DBN-MC-SS	Square & Stem with Casters				\$ 2,850
TB-9642-DBN-MC-D	Diameter with Casters				\$ 2,319
TB-9642-DBN-MC-DS	Diameter & Stem with Casters				\$ 2,850
TB-9642-DBN-FL	Flip Leg (for Nesting Tables)				\$ 3,150
TB-9642-DBN-FD	Folding Leg				\$ 3,150

Each Table Top is constructed using a 1 1/8" thick top with a Plastic Laminate top surface.

All Metal legs are coated electrostatically with an epoxy powder coat paint.

NOTES:

- * Table heights of 25" (children), 27" (youth), and 32" (wheelchair) are available by request.
- * Color of Metal Paint must be specified at the time of order.
- * Caster Leg options are recommended for Reading/Multipurpose Tables options and not meant to be used for stationary computer workstations.
- * For all tables with casters legs, only 2 legs will have casters, and the other legs will have levelers. This will create a "wheelbarrow" style of table which will ensure ease of mobility.
- * Color of the Caster Option must be specified at the time of order.
- * For the Flip OR Fold Leg option, one T-based leg comes with 2 hidden casters as shown in the image below.

Edge Option:



"DBN"
3/4" Dropped Bullnoses Edge

Metal Leg Options:



"M-SQ" Square 2"
"M-SS" Square Stem 2"
"M-D" Diameter 2"
"M-DS" Diameter Stem 2"
"M-BO" Balloon 2 1/2"
"FL" or "FD" Flip OR Fold Leg

Wood Leg Options:

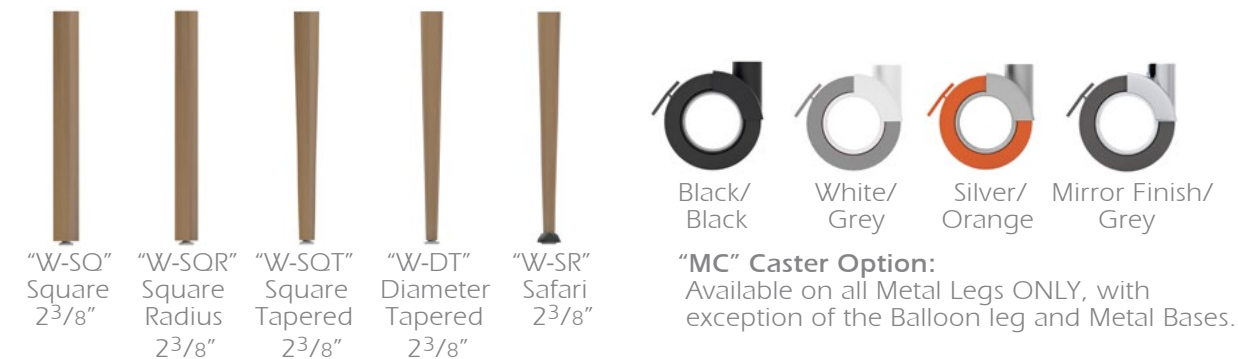

"W-SQ" Square 2 3/8"
"W-SQR" Square Radius 2 3/8"
"W-SQT" Square Tapered 2 3/8"
"W-DT" Diameter Tapered 2 3/8"
"W-SR" Safari 2 3/8"

"MC" Caster Option:
Available on all Metal Legs ONLY, with exception of the Balloon leg and Metal Bases.

MODEL NUMBER

PRODUCT

WIDTH DEPTH HEIGHT

PRICE

DESCRIPTION



*Shown Above:
TB-9642-DBN-M-D



*Rectangle Table Shape

MODEL NUMBER	PRODUCT	WIDTH	DEPTH	HEIGHT	PRICE
	Rectangle Table, 96" Width, 48" Depth	96"	48"	29"	
	DROPPED BULLNOSE Edge;				
	with WOOD Leg Option:	96"	48"	29"	
TB-9648-DBN-W-SQ	Square				\$ 2,206
TB-9648-DBN-W-SQR	Square Radius				\$ 2,206
TB-9648-DBN-W-SQT	Square Tapered				\$ 2,400
TB-9648-DBN-W-DT	Diameter Tapered				\$ 2,556
TB-9648-DBN-W-SR	Safari				\$ 2,569
	with METAL Leg Option:	96"	48"	29"	
TB-9648-DBN-M-SQ	Square				\$ 2,125
TB-9648-DBN-M-SS	Square & Stem				\$ 2,656
TB-9648-DBN-M-D	Diameter				\$ 2,125
TB-9648-DBN-M-DS	Diameter & Stem				\$ 2,656
TB-9648-DBN-M-BO	Balloon				\$ 2,256
TB-9648-DBN-MC-SQ	Square with Casters				\$ 2,413
TB-9648-DBN-MC-SS	Square & Stem with Casters				\$ 2,938
TB-9648-DBN-MC-D	Diameter with Casters				\$ 2,413
TB-9648-DBN-MC-DS	Diameter & Stem with Casters				\$ 2,938
TB-9648-DBN-FL	Flip Leg (for Nesting Tables)				\$ 3,231
TB-9648-DBN-FD	Folding Leg				\$ 3,231

Each Table Top is constructed using a 1 1/8" thick top with a Plastic Laminate top surface.

All Metal legs are coated electrostatically with an epoxy powder coat paint.

NOTES:

- * Table heights of 25" (children), 27" (youth), and 32" (wheelchair) are available by request.
- * Color of Metal Paint must be specified at the time of order.
- * Caster Leg options are recommended for Reading/Multipurpose Tables options and not meant to be used for stationary computer workstations.
- * For all tables with casters legs, only 2 legs will have casters, and the other legs will have levelers. This will create a "wheelbarrow" style of table which will ensure ease of mobility.
- * Color of the Caster Option must be specified at the time of order.
- * For the Flip OR Fold Leg option, one T-based leg comes with 2 hidden casters as shown in the image below.

Edge Option:



"DBN"
3/4" Dropped Bullnoses Edge

Metal Leg Options:



"M-SQ" Square 2"
"M-SS" Square Stem 2"
"M-D" Diameter 2"
"M-DS" Diameter Stem 2"
"M-BO" Balloon 2 1/2"
"FL" or "FD" Flip OR Fold Leg

Wood Leg Options:

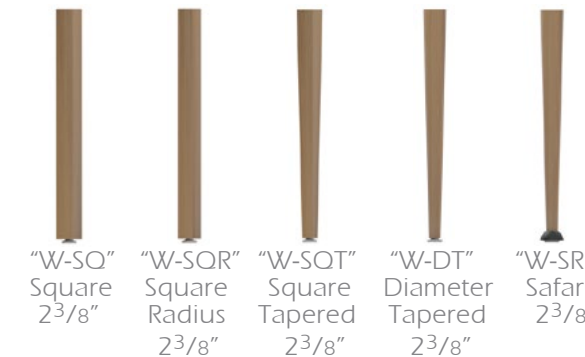

"W-SQ" Square 2 3/8"
"W-SQR" Square Radius 2 3/8"
"W-SQT" Square Tapered 2 3/8"
"W-DT" Diameter Tapered 2 3/8"
"W-SR" Safari 2 3/8"



"MC" Caster Option:
Available on all Metal Legs ONLY, with exception of the Balloon leg and Metal Bases.

MODEL NUMBER

PRODUCT

WIDTH DEPTH HEIGHT

PRICE

DESCRIPTION



*Shown Above:
TB-9642-DCH-M-D



*Rectangle Table Shape

MODEL NUMBER	PRODUCT	WIDTH	DEPTH	HEIGHT	PRICE
	Rectangle Table, 96" Width, 36" Depth	96"	36"	29"	
	DROPPED CHAMFERED Edge;				
	with WOOD Leg Option:	96"	36"	29"	
TB-9636-DCH-W-SQ	Square				\$ 1,856
TB-9636-DCH-W-SQR	Square Radius				\$ 1,856
TB-9636-DCH-W-SQT	Square Tapered				\$ 2,044
TB-9636-DCH-W-DT	Diameter Tapered				\$ 2,206
TB-9636-DCH-W-SR	Safari				\$ 2,219
	with METAL Leg Option:	96"	36"	29"	
TB-9636-DCH-M-SQ	Square				\$ 1,775
TB-9636-DCH-M-SS	Square & Stem				\$ 2,300
TB-9636-DCH-M-D	Diameter				\$ 1,775
TB-9636-DCH-M-DS	Diameter & Stem				\$ 2,300
TB-9636-DCH-M-BO	Balloon				\$ 1,900
TB-9636-DCH-MC-SQ	Square with Casters				\$ 2,056
TB-9636-DCH-MC-SS	Square & Stem with Casters				\$ 2,588
TB-9636-DCH-MC-D	Diameter with Casters				\$ 2,056
TB-9636-DCH-MC-DS	Diameter & Stem with Casters				\$ 2,588
TB-9636-DCH-FL	Flip Leg (for Nesting Tables)				\$ 2,850
TB-9636-DCH-FD	Folding Leg				\$ 2,850
	Rectangle Table, 96" Width, 42" Depth	96"	42"	29"	
	DROPPED CHAMFERED Edge;				
	with WOOD Leg Option:	96"	42"	29"	
TB-9642-DCH-W-SQ	Square				\$ 2,119
TB-9642-DCH-W-SQR	Square Radius				\$ 2,119
TB-9642-DCH-W-SQT	Square Tapered				\$ 2,313
TB-9642-DCH-W-DT	Diameter Tapered				\$ 2,475
TB-9642-DCH-W-SR	Safari				\$ 2,481
	with METAL Leg Option:	96"	42"	29"	
TB-9642-DCH-M-SQ	Square				\$ 2,044
TB-9642-DCH-M-SS	Square & Stem				\$ 2,569
TB-9642-DCH-M-D	Diameter				\$ 2,044
TB-9642-DCH-M-DS	Diameter & Stem				\$ 2,569
TB-9642-DCH-M-BO	Balloon				\$ 2,169
TB-9642-DCH-MC-SQ	Square with Casters				\$ 2,319
TB-9642-DCH-MC-SS	Square & Stem with Casters				\$ 2,850
TB-9642-DCH-MC-D	Diameter with Casters				\$ 2,319
TB-9642-DCH-MC-DS	Diameter & Stem with Casters				\$ 2,850
TB-9642-DCH-FL	Flip Leg (for Nesting Tables)				\$ 3,150
TB-9642-DCH-FD	Folding Leg				\$ 3,150

Each Table Top is constructed using a 1 1/8" thick top with a Plastic Laminate top surface.

All Metal legs are coated electrostatically with an epoxy powder coat paint.

NOTES:

- * Table heights of 25" (children), 27" (youth), and 32" (wheelchair) are available by request.
- * Color of Metal Paint must be specified at the time of order.
- * Caster Leg options are recommended for Reading/Multipurpose Tables options and not meant to be used for stationary computer workstations.
- * For all tables with casters legs, only 2 legs will have casters, and the other legs will have levelers. This will create a "wheelbarrow" style of table which will ensure ease of mobility.
- * Color of the Caster Option must be specified at the time of order.
- * For the Flip OR Fold Leg option, one T-based leg comes with 2 hidden casters as shown in the image below.

Edge Option:



"DCH"
3/4" Dropped Chamfered Edge

Metal Leg Options:



"M-SQ" Square 2"
"M-SS" Square Stem 2"
"M-D" Diameter 2"
"M-DS" Diameter Stem 2"
"M-BO" Balloon 2 1/2"
"FL" or "FD" Flip OR Fold Leg

Wood Leg Options:

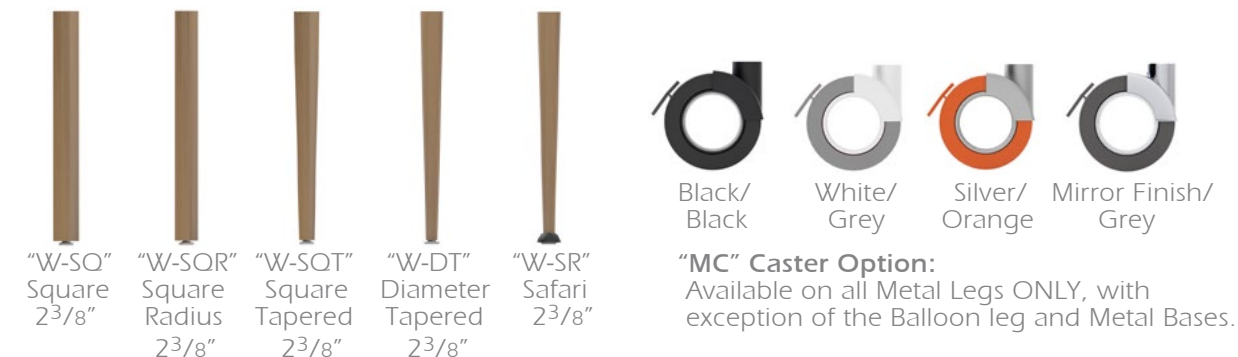

"W-SQ" Square 2 3/8"
"W-SQR" Square Radius 2 3/8"
"W-SQT" Square Tapered 2 3/8"
"W-DT" Diameter Tapered 2 3/8"
"W-SR" Safari 2 3/8"

Black/Black White/Grey Silver/Orange Mirror Finish/Grey

"MC" Caster Option:
Available on all Metal Legs ONLY, with exception of the Balloon leg and Metal Bases.

MODEL NUMBER

PRODUCT

WIDTH DEPTH HEIGHT

PRICE

DESCRIPTION



*Shown Above:
TB-9642-DCH-M-D



*Rectangle Table Shape

MODEL NUMBER	PRODUCT	WIDTH	DEPTH	HEIGHT	PRICE
	Rectangle Table, 96" Width, 48" Depth	96"	48"	29"	
	DROPPED CHAMFERED Edge;				
	with WOOD Leg Option:	96"	48"	29"	
TB-9648-DCH-W-SQ	Square				\$ 2,206
TB-9648-DCH-W-SQR	Square Radius				\$ 2,206
TB-9648-DCH-W-SQT	Square Tapered				\$ 2,400
TB-9648-DCH-W-DT	Diameter Tapered				\$ 2,556
TB-9648-DCH-W-SR	Safari				\$ 2,569
	with METAL Leg Option:	96"	48"	29"	
TB-9648-DCH-M-SQ	Square				\$ 2,125
TB-9648-DCH-M-SS	Square & Stem				\$ 2,656
TB-9648-DCH-M-D	Diameter				\$ 2,125
TB-9648-DCH-M-DS	Diameter & Stem				\$ 2,656
TB-9648-DCH-M-BO	Balloon				\$ 2,256
TB-9648-DCH-MC-SQ	Square with Casters				\$ 2,413
TB-9648-DCH-MC-SS	Square & Stem with Casters				\$ 2,938
TB-9648-DCH-MC-D	Diameter with Casters				\$ 2,413
TB-9648-DCH-MC-DS	Diameter & Stem with Casters				\$ 2,938
TB-9648-DCH-FL	Flip Leg (for Nesting Tables)				\$ 3,231
TB-9648-DCH-FD	Folding Leg				\$ 3,231

Each Table Top is constructed using a 1 1/8" thick top with a Plastic Laminate top surface.

All Metal legs are coated electrostatically with an epoxy powder coat paint.

NOTES:

- * Table heights of 25" (children), 27" (youth), and 32" (wheelchair) are available by request.
- * Color of Metal Paint must be specified at the time of order.
- * Caster Leg options are recommended for Reading/Multipurpose Tables options and not meant to be used for stationary computer workstations.
- * For all tables with casters legs, only 2 legs will have casters, and the other legs will have levelers. This will create a "wheelbarrow" style of table which will ensure ease of mobility.
- * Color of the Caster Option must be specified at the time of order.
- * For the Flip OR Fold Leg option, one T-based leg comes with 2 hidden casters as shown in the image below.

Edge Option:



"DCH"
3/4" Dropped Chamfered Edge

Metal Leg Options:

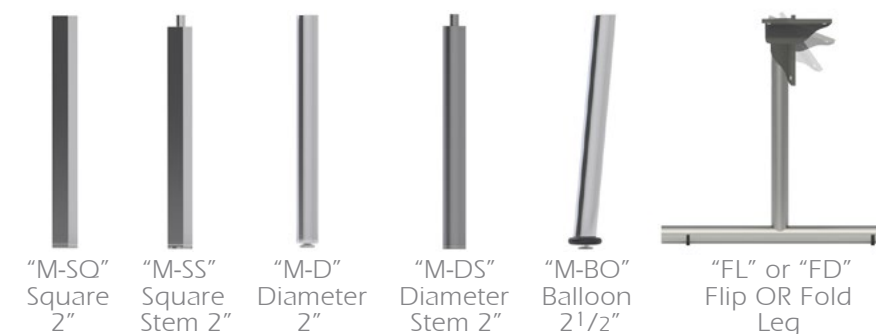

"M-SQ" Square 2"
"M-SS" Square Stem 2"
"M-D" Diameter 2"
"M-DS" Diameter Stem 2"
"M-BO" Balloon 2 1/2"
"FL" or "FD" Flip OR Fold Leg

Wood Leg Options:

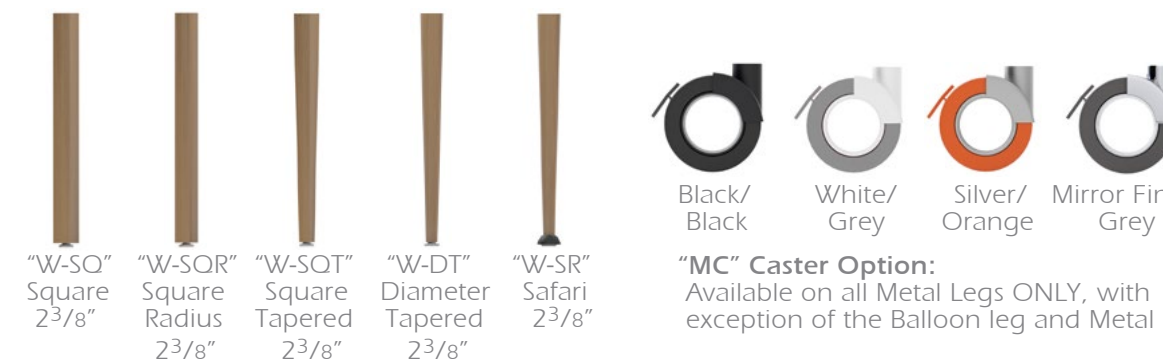

"W-SQ" Square 2 3/8"
"W-SQR" Square Radius 2 3/8"
"W-SQT" Square Tapered 2 3/8"
"W-DT" Diameter Tapered 2 3/8"
"W-SR" Safari 2 3/8"

Black/Black White/Grey Silver/Orange Mirror Finish/Grey

"MC" Caster Option:
Available on all Metal Legs ONLY, with exception of the Balloon leg and Metal Bases.

MODEL NUMBER

PRODUCT

WIDTH DEPTH HEIGHT

PRICE

DESCRIPTION



*Shown Above:
TB-9642-AL-M-D

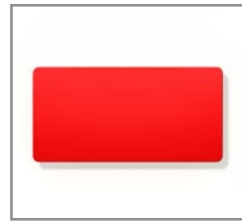

*Rectangle Table Shape

MODEL NUMBER	PRODUCT	WIDTH	DEPTH	HEIGHT
	Rectangle Table, 96" Width, 36" Depth	96"	36"	29"
	ALUMINUM Edge;			
	with WOOD Leg Option:	96"	36"	29"
TB-9636-AL-W-SQ	Square			
TB-9636-AL-W-SQR	Square Radius			
TB-9636-AL-W-SQT	Square Tapered			
TB-9636-AL-W-DT	Diameter Tapered			
TB-9636-AL-W-SR	Safari			
	with METAL Leg Option:	96"	36"	29"
TB-9636-AL-M-SQ	Square			
TB-9636-AL-M-SS	Square & Stem			
TB-9636-AL-M-D	Diameter			
TB-9636-AL-M-DS	Diameter & Stem			
TB-9636-AL-M-BO	Balloon			
TB-9636-AL-MC-SQ	Square with Casters			
TB-9636-AL-MC-SS	Square & Stem with Casters			
TB-9636-AL-MC-D	Diameter with Casters			
TB-9636-AL-MC-DS	Diameter & Stem with Casters			
TB-9636-AL-FL	Flip Leg (for Nesting Tables)			
TB-9636-AL-FD	Folding Leg			
	Rectangle Table, 96" Width, 42" Depth	96"	42"	29"
	ALUMINUM Edge;			
	with WOOD Leg Option:	96"	42"	29"
TB-9642-AL-W-SQ	Square			
TB-9642-AL-W-SQR	Square Radius			
TB-9642-AL-W-SQT	Square Tapered			
TB-9642-AL-W-DT	Diameter Tapered			
TB-9642-AL-W-SR	Safari			
	with METAL Leg Option:	96"	42"	29"
TB-9642-AL-M-SQ	Square			
TB-9642-AL-M-SS	Square & Stem			
TB-9642-AL-M-D	Diameter			
TB-9642-AL-M-DS	Diameter & Stem			
TB-9642-AL-M-BO	Balloon			
TB-9642-AL-MC-SQ	Square with Casters			
TB-9642-AL-MC-SS	Square & Stem with Casters			
TB-9642-AL-MC-D	Diameter with Casters			
TB-9642-AL-MC-DS	Diameter & Stem with Casters			
TB-9642-AL-FL	Flip Leg (for Nesting Tables)			
TB-9642-AL-FD	Folding Leg			

\$ 1,688
\$ 1,688
\$ 1,781
\$ 1,944
\$ 1,956

\$ 1,513
\$ 2,044
\$ 1,513
\$ 2,044
\$ 1,644
\$ 1,794
\$ 2,325
\$ 1,794
\$ 2,325
\$ 2,594
\$ 2,594

\$ 1,844
\$ 1,844
\$ 2,038
\$ 2,200
\$ 2,206

\$ 1,763
\$ 2,300
\$ 1,763
\$ 2,300
\$ 1,894
\$ 2,050
\$ 2,575
\$ 2,050
\$ 2,575
\$ 2,875
\$ 2,875

Each Table Top is constructed using a 1 1/8" thick top with a Plastic Laminate top surface.

All Metal legs are coated electrostatically with an epoxy powder coat paint.

NOTES:

- * Table heights of 25" (children), 27" (youth), and 32" (wheelchair) are available by request.
- * Color of Metal Paint must be specified at the time of order.
- * Caster Leg options are recommended for Reading/Multipurpose Tables options and not meant to be used for stationary computer workstations.
- * For all tables with casters legs, only 2 legs will have casters, and the other legs will have levelers. This will create a "wheelbarrow" style of table which will ensure ease of mobility.
- * Color of the Caster Option must be specified at the time of order.
- * For the Flip OR Fold Leg option, one T-based leg comes with 2 hidden casters as shown in the image below.

Edge Option:



"AL"

3mm Aluminum Edge *All table corners will be given a 6-inch radius for this edge option.

Metal Leg Options:

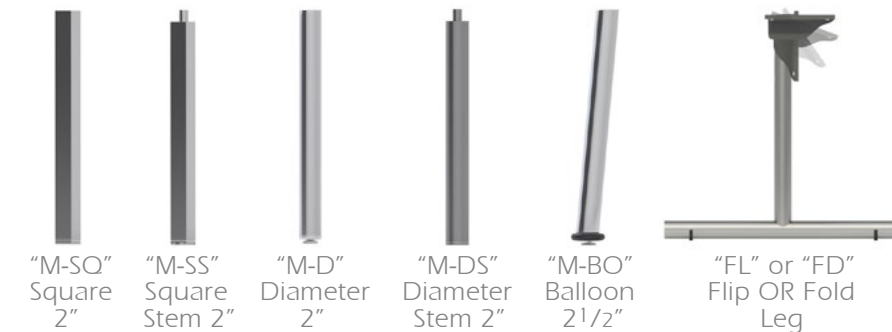

"M-SQ" Square 2"
"M-SS" Square Stem 2"
"M-D" Diameter 2"
"M-DS" Diameter Stem 2"
"M-BO" Balloon 2 1/2"
"FL" or "FD" Flip OR Fold Leg

Wood Leg Options:

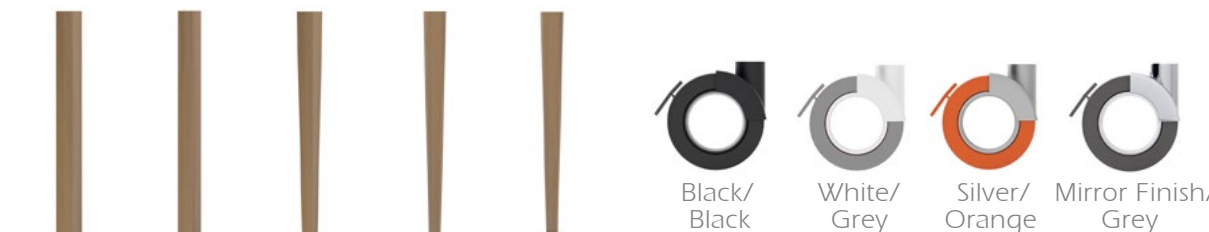

"W-SQ" Square 2 3/8"
"W-SQR" Square Radius 2 3/8"
"W-SQT" Square Tapered 2 3/8"
"W-DT" Diameter Tapered 2 3/8"
"W-SR" Safari 2 3/8"

"MC" Caster Option:
Available on all Metal Legs ONLY, with exception of the Balloon leg and Metal Bases.

MODEL NUMBER

PRODUCT

WIDTH DEPTH HEIGHT

PRICE

DESCRIPTION



*Shown Above:
TB-9642-AL-M-D



*Rectangle Table Shape

MODEL NUMBER	PRODUCT	WIDTH	DEPTH	HEIGHT	PRICE
	Rectangle Table, 96" Width, 48" Depth	96"	48"	29"	
	ALUMINUM Edge;				
	with WOOD Leg Option:	96"	48"	29"	
TB-9648-AL-W-SQ	Square				\$ 1,925
TB-9648-AL-W-SQR	Square Radius				\$ 1,925
TB-9648-AL-W-SQT	Square Tapered				\$ 2,113
TB-9648-AL-W-DT	Diameter Tapered				\$ 2,275
TB-9648-AL-W-SR	Safari				\$ 2,281
	with METAL Leg Option:	96"	48"	29"	
TB-9648-AL-M-SQ	Square				\$ 1,844
TB-9648-AL-M-SS	Square & Stem				\$ 2,375
TB-9648-AL-M-D	Diameter				\$ 1,844
TB-9648-AL-M-DS	Diameter & Stem				\$ 2,375
TB-9648-AL-M-BO	Balloon				\$ 1,969
TB-9648-AL-MC-SQ	Square with Casters				\$ 2,125
TB-9648-AL-MC-SS	Square & Stem with Casters				\$ 2,656
TB-9648-AL-MC-D	Diameter with Casters				\$ 2,125
TB-9648-AL-MC-DS	Diameter & Stem with Casters				\$ 2,656
TB-9648-AL-FL	Flip Leg (for Nesting Tables)				\$ 2,950
TB-9648-AL-FD	Folding Leg				\$ 2,950

Each Table Top is constructed using a 1 1/8" thick top with a Plastic Laminate top surface.

All Metal legs are coated electrostatically with an epoxy powder coat paint.

NOTES:

- * Table heights of 25" (children), 27" (youth), and 32" (wheelchair) are available by request.
- * Color of Metal Paint must be specified at the time of order.
- * Caster Leg options are recommended for Reading/Multipurpose Tables options and not meant to be used for stationary computer workstations.
- * For all tables with casters legs, only 2 legs will have casters, and the other legs will have levelers. This will create a "wheelbarrow" style of table which will ensure ease of mobility.
- * Color of the Caster Option must be specified at the time of order.
- * For the Flip OR Fold Leg option, one T-based leg comes with 2 hidden casters as shown in the image below.

Edge Option:



"AL"
3mm Aluminum Edge *All table corners will be given a 6-inch radius for this edge option.

Metal Leg Options:

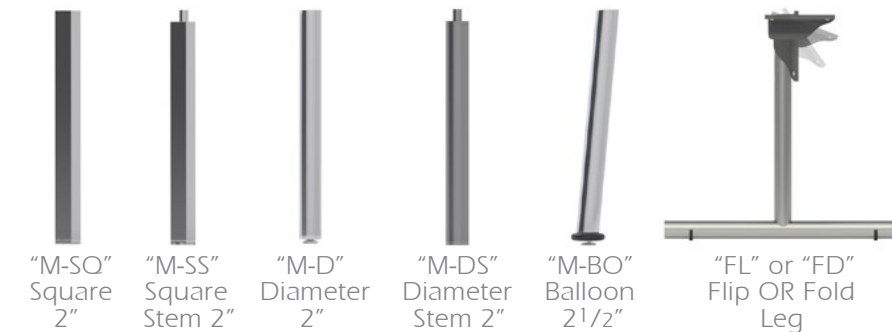

"M-SQ" Square 2"
"M-SS" Square Stem 2"
"M-D" Diameter 2"
"M-DS" Diameter Stem 2"
"M-BO" Balloon 2 1/2"
"FL" or "FD" Flip OR Fold Leg

Wood Leg Options:

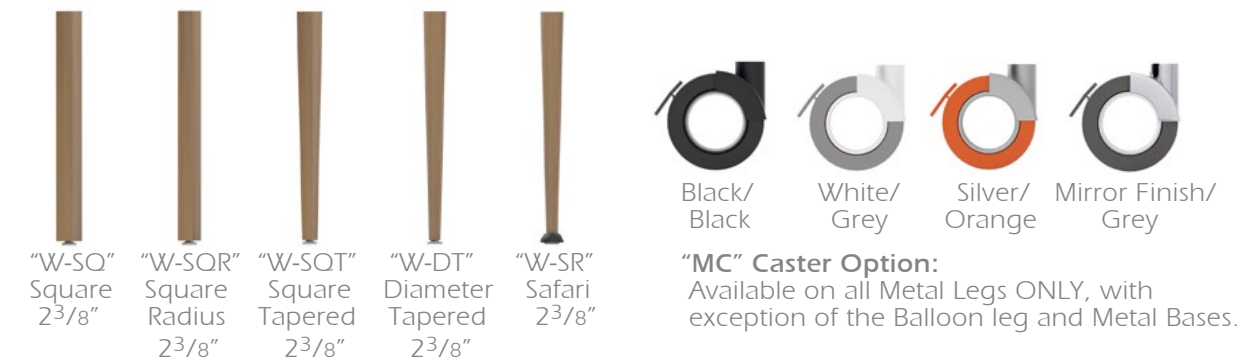

"W-SQ" Square 2 3/8"
"W-SQR" Square Radius 2 3/8"
"W-SQT" Square Tapered 2 3/8"
"W-DT" Diameter Tapered 2 3/8"
"W-SR" Safari 2 3/8"

Black/Black White/Grey Silver/Orange Mirror Finish/Grey

"MC" Caster Option:
Available on all Metal Legs ONLY, with exception of the Balloon leg and Metal Bases.

MODEL NUMBER
PRODUCT
WIDTH DEPTH HEIGHT
PRICE
DESCRIPTION

*Shown Above:
TB-TZ4824-AC-M-D

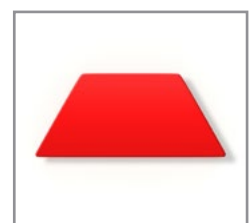

*Trapezoidal Table Shape

MODEL NUMBER	PRODUCT	WIDTH	DEPTH	HEIGHT	PRICE
	Trapezoidal Table, 48" Width, 24" Depth	48"	24"	29"	
	ACRYLIC Edge;				
	with WOOD Leg Option:	48"	24"	29"	
TB-TZ4824-AC-W-SQ	Square				\$ 1,050
TB-TZ4824-AC-W-SQR	Square Radius				\$ 1,050
TB-TZ4824-AC-W-SQT	Square Tapered				\$ 1,244
TB-TZ4824-AC-W-DT	Diameter Tapered				\$ 1,406
TB-TZ4824-AC-W-SR	Safari				\$ 1,413
	with METAL Leg Option:	48"	24"	29"	
TB-TZ4824-AC-M-SQ	Square				\$ 975
TB-TZ4824-AC-M-SS	Square & Stem				\$ 1,500
TB-TZ4824-AC-M-D	Diameter				\$ 975
TB-TZ4824-AC-M-DS	Diameter & Stem				\$ 1,500
TB-TZ4824-AC-M-BO	Balloon				\$ 1,100
TB-TZ4824-AC-MC-SQ	Square with Casters				\$ 1,250
TB-TZ4824-AC-MC-SS	Square & Stem with Casters				\$ 1,781
TB-TZ4824-AC-MC-D	Diameter with Casters				\$ 1,250
TB-TZ4824-AC-MC-DS	Diameter & Stem with Casters				\$ 1,781
	Trapezoidal Table, 60" Width, 30" Depth	60"	30"	29"	
	ACRYLIC Edge;				
	with WOOD Leg Option:	60"	30"	29"	
TB-TZ6030-AC-W-SQ	Square				\$ 1,231
TB-TZ6030-AC-W-SQR	Square Radius				\$ 1,231
TB-TZ6030-AC-W-SQT	Square Tapered				\$ 1,419
TB-TZ6030-AC-W-DT	Diameter Tapered				\$ 1,581
TB-TZ6030-AC-W-SR	Safari				\$ 1,588
	with METAL Leg Option:	60"	30"	29"	
TB-TZ6030-AC-M-SQ	Square				\$ 1,150
TB-TZ6030-AC-M-SS	Square & Stem				\$ 1,675
TB-TZ6030-AC-M-D	Diameter				\$ 1,150
TB-TZ6030-AC-M-DS	Diameter & Stem				\$ 1,675
TB-TZ6030-AC-M-BO	Balloon				\$ 1,275
TB-TZ6030-AC-MC-SQ	Square with Casters				\$ 1,425
TB-TZ6030-AC-MC-SS	Square & Stem with Casters				\$ 1,963
TB-TZ6030-AC-MC-D	Diameter with Casters				\$ 1,425
TB-TZ6030-AC-MC-DS	Diameter & Stem with Casters				\$ 1,963

Each Table Top is constructed using a 1" thick top with a Plastic Laminate top surface.

All Metal legs are coated electrostatically with an epoxy powder coat paint.

NOTES:

- * Table heights of 25" (children), 27" (youth), and 32" (wheelchair) are available by request.
- * Color of Metal Paint must be specified at the time of order.
- * Caster Leg options are recommended for Reading/Multipurpose Tables options and not meant to be used for stationary computer workstations.
- * For all tables with casters legs, only 2 legs will have casters, and the other legs will have levelers. This will create a "wheelbarrow" style of table which will ensure ease of mobility.
- * Color of the Caster Option must be specified at the time of order.

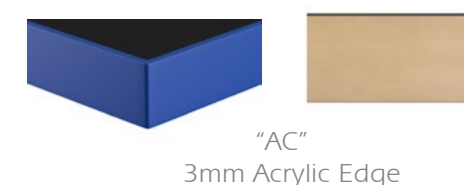
Edge Option:

"AC"
3mm Acrylic Edge

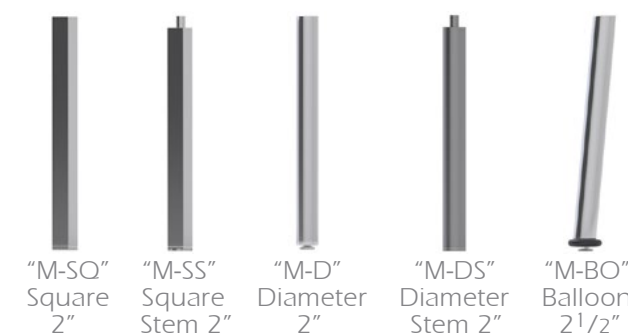
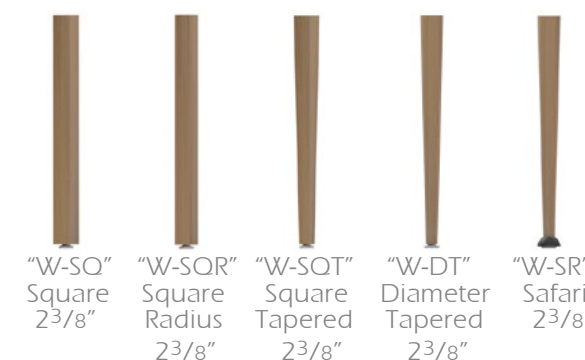
Metal Leg Options:

Wood Leg Options:

"MC" Caster Option:
Available on all Metal Legs ONLY, with exception of the Balloon leg and Metal Bases.

MODEL NUMBER **PRODUCT** **WIDTH** **DEPTH** **HEIGHT**



*Shown Above:
TB-TZ4824-SQ-M-D



*Trapezoidal Table Shape

	Trapezoidal Table, 48" Width, 24" Depth	48"	24"	29"
	SQUARE Edge;			
	with WOOD Leg Option:	48"	24"	29"
TB-TZ4824-SQ-W-SQ	Square			
TB-TZ4824-SQ-W-SQR	Square Radius			
TB-TZ4824-SQ-W-SQT	Square Tapered			
TB-TZ4824-SQ-W-DT	Diameter Tapered			
TB-TZ4824-SQ-W-SR	Safari			
	with METAL Leg Option:	48"	24"	29"
TB-TZ4824-SQ-M-SQ	Square			
TB-TZ4824-SQ-M-SS	Square & Stem			
TB-TZ4824-SQ-M-D	Diameter			
TB-TZ4824-SQ-M-DS	Diameter & Stem			
TB-TZ4824-SQ-M-BO	Balloon			
TB-TZ4824-SQ-MC-SQ	Square with Casters			
TB-TZ4824-SQ-MC-SS	Square & Stem with Casters			
TB-TZ4824-SQ-MC-D	Diameter with Casters			
TB-TZ4824-SQ-MC-DS	Diameter & Stem with Casters			
	Trapezoidal Table, 60" Width, 30" Depth	60"	30"	29"
	SQUARE Edge;			
	with WOOD Leg Option:	60"	30"	29"
TB-TZ6030-SQ-W-SQ	Square			
TB-TZ6030-SQ-W-SQR	Square Radius			
TB-TZ6030-SQ-W-SQT	Square Tapered			
TB-TZ6030-SQ-W-DT	Diameter Tapered			
TB-TZ6030-SQ-W-SR	Safari			
	with METAL Leg Option:	60"	30"	29"
TB-TZ6030-SQ-M-SQ	Square			
TB-TZ6030-SQ-M-SS	Square & Stem			
TB-TZ6030-SQ-M-D	Diameter			
TB-TZ6030-SQ-M-DS	Diameter & Stem			
TB-TZ6030-SQ-M-BO	Balloon			
TB-TZ6030-SQ-MC-SQ	Square with Casters			
TB-TZ6030-SQ-MC-SS	Square & Stem with Casters			
TB-TZ6030-SQ-MC-D	Diameter with Casters			
TB-TZ6030-SQ-MC-DS	Diameter & Stem with Casters			

PRICE **DESCRIPTION**

Each Table Top is constructed using a 1 1/8" thick top with a Plastic Laminate top surface.

All Metal legs are coated electrostatically with an epoxy powder coat paint.

NOTES:

- * Table heights of 25" (children), 27" (youth), and 32" (wheelchair) are available by request.
- * Color of Metal Paint must be specified at the time of order.
- * Caster Leg options are recommended for Reading/Multipurpose Tables options and not meant to be used for stationary computer workstations.
- * For all tables with casters legs, only 2 legs will have casters, and the other legs will have levelers. This will create a "wheelbarrow" style of table which will ensure ease of mobility.
- * Color of the Caster Option must be specified at the time of order.

\$ 1,194
\$ 1,194
\$ 1,388
\$ 1,544
\$ 1,550

\$ 1,113
\$ 1,644
\$ 1,113
\$ 1,644
\$ 1,244
\$ 1,394
\$ 1,925
\$ 1,394
\$ 1,925

Edge Option:



"SQ"
1/4" Square Edge

Metal Leg Options:

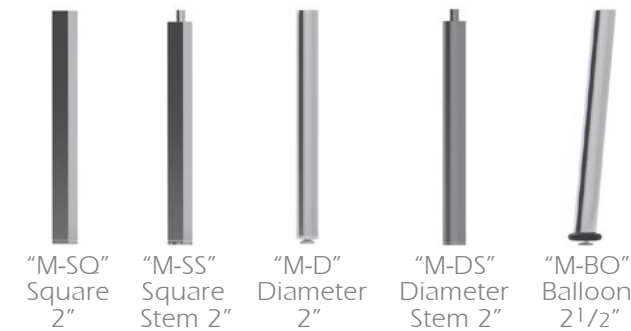

"M-SQ" Square 2"
"M-SS" Square Stem 2"
"M-D" Diameter 2"
"M-DS" Diameter Stem 2"
"M-BO" Balloon 2 1/2"

Wood Leg Options:

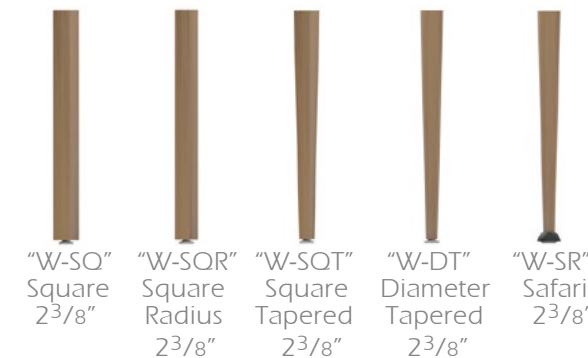

"W-SQ" Square 2 3/8"
"W-SQR" Square Radius 2 3/8"
"W-SQT" Square Tapered 2 3/8"
"W-DT" Diameter Tapered 2 3/8"
"W-SR" Safari 2 3/8"



"MC" Caster Option:
Available on all Metal Legs ONLY, with exception of the Balloon leg and Metal Bases.

MODEL NUMBER

PRODUCT

WIDTH DEPTH HEIGHT

PRICE

DESCRIPTION



*Shown Above:
TB-T30-AC-M-D



*Triangle Table Shape

TB-T30-AC-W-SQ
TB-T30-AC-W-SQR
TB-T30-AC-W-SQT
TB-T30-AC-W-DT
TB-T30-AC-W-SR

Triangle Table, 30" Width,
ACRYLIC Edge;
with WOOD Leg Option:
Square
Square Radius
Square Tapered
Diameter Tapered
Safari

30" 30" 29"

\$ 950
\$ 950
\$ 1,094
\$ 1,213
\$ 1,225

TB-T30-AC-M-SQ
TB-T30-AC-M-SS
TB-T30-AC-M-D
TB-T30-AC-M-DS
TB-T30-AC-M-BO

with METAL Leg Option:
Square
Square & Stem
Diameter
Diameter & Stem
Balloon

30" 30" 29"

\$ 894
\$ 1,288
\$ 894
\$ 1,288
\$ 988

Triangle Table, 36" Width,
ACRYLIC Edge;

36" 36" 29"

TB-T36-AC-W-SQ
TB-T36-AC-W-SQR
TB-T36-AC-W-SQT
TB-T36-AC-W-DT
TB-T36-AC-W-SR

with WOOD Leg Option:
Square
Square Radius
Square Tapered
Diameter Tapered
Safari

36" 36" 29"

\$ 1,000
\$ 1,000
\$ 1,144
\$ 1,269
\$ 1,275

TB-T36-AC-M-SQ
TB-T36-AC-M-SS
TB-T36-AC-M-D
TB-T36-AC-M-DS
TB-T36-AC-M-BO

with METAL Leg Option:
Square
Square & Stem
Diameter
Diameter & Stem
Balloon

36" 36" 29"

\$ 944
\$ 1,338
\$ 944
\$ 1,338
\$ 1,038

Each Table Top is constructed using a 1" thick top with a Plastic Laminate top surface.

All Metal legs are coated electrostatically with an epoxy powder coat paint.

NOTES:

* Table heights of 25" (children), 27" (youth), and 32" (wheelchair) are available by request.

* Color of Metal Paint must be specified at the time of order.

Edge Option:



"AC"

3mm Acrylic Edge

Metal Leg Options:

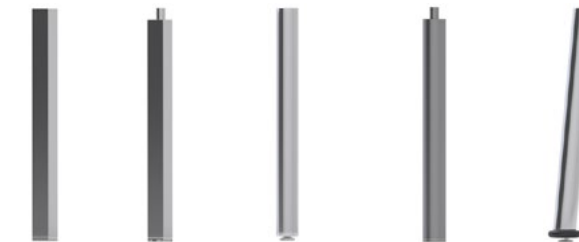

"M-SQ" Square 2"
"M-SS" Square Stem 2"
"M-D" Diameter 2"
"M-DS" Diameter Stem 2"
"M-BO" Balloon 2 1/2"

Wood Leg Options:



"W-SQ" Square 2 3/8"
"W-SQR" Square Radius 2 3/8"
"W-SQT" Square Tapered 2 3/8"
"W-DT" Diameter Tapered 2 3/8"
"W-SR" Safari 2 3/8"

MODEL NUMBER

PRODUCT

WIDTH DEPTH HEIGHT

PRICE

DESCRIPTION



*Shown Above:
TB-TS48-AC-M-D



*Trio-Squared Table
Shape

TB-TS48-AC-W-SQ
TB-TS48-AC-W-SQR
TB-TS48-AC-W-SQT
TB-TS48-AC-W-DT
TB-TS48-AC-W-SR

Trio-Squared Table, 48" Width,
ACRYLIC Edge;
with WOOD Leg Option:
Square
Square Radius
Square Tapered
Diameter Tapered
Safari

48" 48" 29"

TB-TS48-AC-M-SQ
TB-TS48-AC-M-SS
TB-TS48-AC-M-D
TB-TS48-AC-M-DS
TB-TS48-AC-M-BO

with METAL Leg Option:
Square
Square & Stem
Diameter
Diameter & Stem
Balloon

48" 48" 29"

TB-TS48-AC-FP1
TB-TS48-AC-FP2
TB-TS48-AC-FP3
TB-TS48-AC-TP1
TB-TS48-AC-TP2
TB-TS48-AC-TP3

Flat Pedestal 19" H
Flat Pedestal 29" H
Flat Pedestal 42" H
Trumpet 19" H
Trumpet 29" H
Trumpet 42" H

48" 48" 19"
48" 48" 29"
48" 48" 42"
48" 48" 19"
48" 48" 29"
48" 48" 42"

\$ 1,275
\$ 1,275
\$ 1,419
\$ 1,544
\$ 1,550

\$ 1,213
\$ 1,613
\$ 1,213
\$ 1,613
\$ 1,313

\$ 2,400
\$ 2,400
\$ 2,494
\$ 1,644
\$ 1,644
\$ 1,869

Each Table Top is constructed using a 1" thick top with a Plastic Laminate top surface.

All Metal legs are coated electrostatically with an epoxy powder coat paint.

NOTES:

* Table heights of 25" (children), 27" (youth), and 32" (wheelchair) are available by request.

* Color of Metal Paint must be specified at the time of order.

Edge Option:

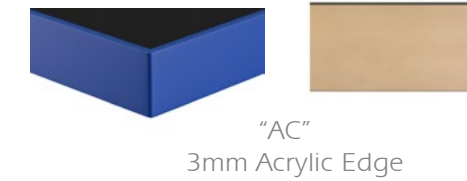

"AC"
3mm Acrylic Edge

Metal Leg Options:



"M-SQ" Square 2"
"M-SS" Square Stem 2"
"M-D" Diameter 2"
"M-DS" Diameter Stem 2"
"M-BO" Balloon 2 1/2"
"FP" Flat Pedestal Base
"TP" Trumpet Base

Wood Leg Options:

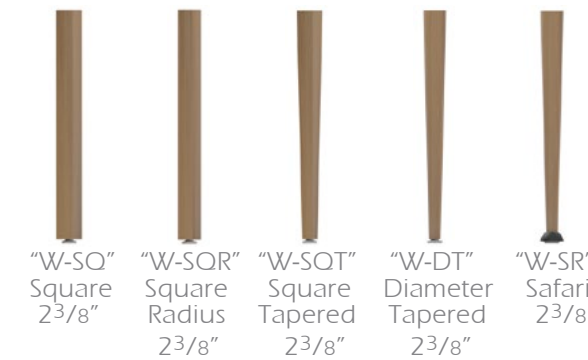

"W-SQ" Square 2 3/8"
"W-SQR" Square Radius 2 3/8"
"W-SQT" Square Tapered 2 3/8"
"W-DT" Diameter Tapered 2 3/8"
"W-SR" Safari 2 3/8"

MODEL NUMBER	PRODUCT	WIDTH	DEPTH	HEIGHT
--------------	---------	-------	-------	--------



*Shown Above:
TB-TS60-AC-M-D

Trio-Squared Table, 60" Width, 60" 60" 29"

ACRYLIC Edge;

with WOOD Leg Option: 60" 60" 29"

- TB-TS60-AC-W-SQ Square
- TB-TS60-AC-W-SQR Square Radius
- TB-TS60-AC-W-SQT Square Tapered
- TB-TS60-AC-W-DT Diameter Tapered
- TB-TS60-AC-W-SR Safari

with METAL Leg Option: 60" 60" 29"

- TB-TS60-AC-M-SQ Square
- TB-TS60-AC-M-SS Square & Stem
- TB-TS60-AC-M-D Diameter
- TB-TS60-AC-M-DS Diameter & Stem
- TB-TS60-AC-M-BO Balloon
- TB-TS60-AC-MC-SQ Square with Casters
- TB-TS60-AC-MC-SS Square & Stem with Casters
- TB-TS60-AC-MC-D Diameter with Casters
- TB-TS60-AC-MC-DS Diameter & Stem with Casters



*Trio-Squared Table Shape

PRICE	DESCRIPTION
-------	-------------

- \$ 2,019
- \$ 2,019
- \$ 2,300
- \$ 2,544
- \$ 2,556

- \$ 1,894
- \$ 2,688
- \$ 1,894
- \$ 2,688
- \$ 2,088
- \$ 2,038
- \$ 2,831
- \$ 2,038
- \$ 2,831

Each Table Top is constructed using a 1" thick top with a Plastic Laminate top surface.

All Metal legs are coated electrostatically with an epoxy powder coat paint.

NOTES:

- * Table heights of 25" (children), 27" (youth), and 32" (wheelchair) are available by request.
- * Color of Metal Paint must be specified at the time of order.
- * Caster Leg options are recommended for Reading/Multipurpose Tables options and not meant to be used for stationary computer workstations.
- * For all tables with casters legs, only 2 legs will have casters, and the other legs will have levelers. This will create a "wheelbarrow" style of table which will ensure ease of mobility.
- * Color of the Caster Option must be specified at the time of order.

Edge Option:



"AC"
3mm Acrylic Edge

Metal Leg Options:



"M-SQ" Square 2"
"M-SS" Square Stem 2"
"M-D" Diameter 2"
"M-DS" Diameter Stem 2"
"M-BO" Balloon 2 1/2"

Wood Leg Options:





"W-SQ" Square 2 3/8"
"W-SQR" Square Radius 2 3/8"
"W-SQT" Square Tapered 2 3/8"
"W-DT" Diameter Tapered 2 3/8"
"W-SR" Safari 2 3/8"



Black/Black White/Grey Silver/Orange Mirror Finish/Grey

"MC" Caster Option:
Available on all Metal Legs ONLY, with exception of the Balloon leg and Metal Bases.

MODEL NUMBER	PRODUCT	WIDTH	DEPTH	HEIGHT
 *Shown Above: TB-TR48-AC-M-D	Trio-Round Table, 48" Width, ACRYLIC Edge;	48"	48"	29"
	with WOOD Leg Option:	48"	48"	29"
	TB-TR48-AC-W-SQ Square			
	TB-TR48-AC-W-SQR Square Radius			
	TB-TR48-AC-W-SQT Square Tapered			
TB-TR48-AC-W-DT Diameter Tapered				
TB-TR48-AC-W-SR Safari				
 *Trio-Round Table Shape	with METAL Leg Option:	48"	48"	29"
	TB-TR48-AC-M-SQ Square			
	TB-TR48-AC-M-SS Square & Stem			
	TB-TR48-AC-M-D Diameter			
	TB-TR48-AC-M-DS Diameter & Stem			
TB-TR48-AC-M-BO Balloon				
TB-TR48-AC-FP1 Flat Pedestal 19" H	48"	48"	19"	
TB-TR48-AC-FP2 Flat Pedestal 29" H	48"	48"	29"	
TB-TR48-AC-FP3 Flat Pedestal 42" H	48"	48"	42"	
TB-TR48-AC-TP1 Trumpet 19" H	48"	48"	19"	
TB-TR48-AC-TP2 Trumpet 29" H	48"	48"	29"	
TB-TR48-AC-TP3 Trumpet 42" H	48"	48"	42"	

PRICE

\$ 1,231
\$ 1,231
\$ 1,369
\$ 1,488
\$ 1,500

\$ 1,169
\$ 1,569
\$ 1,169
\$ 1,569
\$ 1,263

\$ 2,350
\$ 2,350
\$ 2,444
\$ 1,600
\$ 1,600
\$ 1,825

DESCRIPTION

Each Table Top is constructed using a 1" thick top with a Plastic Laminate top surface.

All Metal legs are coated electrostatically with an epoxy powder coat paint.

NOTES:

* Table heights of 25" (children), 27" (youth), and 32" (wheelchair) are available by request.

* Color of Metal Paint must be specified at the time of order.

Edge Option:

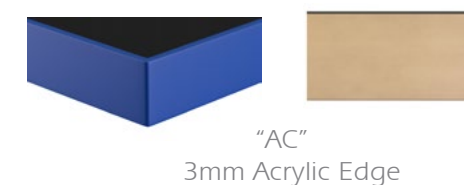



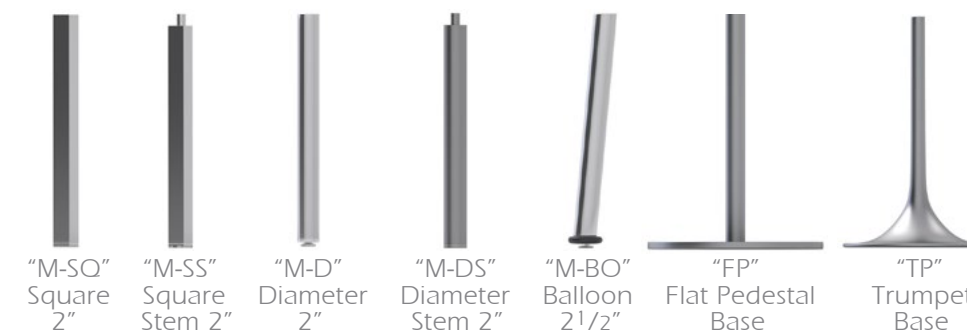

Metal Leg Options:

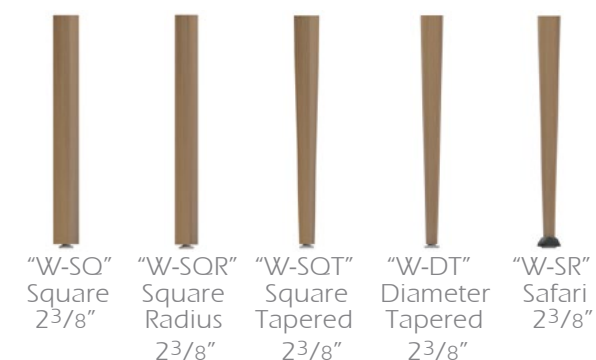

Wood Leg Options:



MODEL NUMBER	PRODUCT	WIDTH	DEPTH	HEIGHT
 <p>*Shown Above: TB-TR60-AC-M-D</p>	Trio-Round Table, 60" Width, ACRYLIC Edge;	60"	60"	29"
	with WOOD Leg Option:	60"	60"	29"
	TB-TR60-AC-W-SQ Square			
	TB-TR60-AC-W-SQR Square Radius			
	TB-TR60-AC-W-SQT Square Tapered			
TB-TR60-AC-W-DT Diameter Tapered				
TB-TR60-AC-W-SR Safari				
 <p>*Trio-Round Table Shape</p>	with METAL Leg Option:	60"	60"	29"
	TB-TR60-AC-M-SQ Square			
	TB-TR60-AC-M-SS Square & Stem			
	TB-TR60-AC-M-D Diameter			
	TB-TR60-AC-M-DS Diameter & Stem			
TB-TR60-AC-M-BO Balloon				

PRICE	DESCRIPTION
	Each Table Top is constructed using a 1" thick top with a Plastic Laminate top surface.
	All Metal legs are coated electrostatically with an epoxy powder coat paint.
	NOTES: * Table heights of 25" (children), 27" (youth), and 32" (wheelchair) are available by request. * Color of Metal Paint must be specified at the time of order.
\$ 1,638	Edge Option:   <p>"AC" 3mm Acrylic Edge</p>
\$ 1,638	
\$ 1,781	
\$ 1,900	
\$ 1,906	
\$ 1,581	Metal Leg Options:  <p>"M-SQ" Square 2" "M-SS" Square Stem 2" "M-D" Diameter 2" "M-DS" Diameter Stem 2" "M-BO" Balloon 2 1/2"</p>
\$ 1,975	
\$ 1,581	
\$ 1,975	
\$ 1,675	
	Wood Leg Options:  <p>"W-SQ" Square 2 3/8" "W-SQR" Square Radius 2 3/8" "W-SQT" Square Tapered 2 3/8" "W-DT" Diameter Tapered 2 3/8" "W-SR" Safari 2 3/8"</p>

MODEL NUMBER
PRODUCT
WIDTH DEPTH HEIGHT
PRICE
DESCRIPTION

*Shown Above:
TB-TL48-AC-M-D

Trio-Link Table, 48" Width,
ACRYLIC Edge;
with WOOD Leg Option:
Square 48" 48" 29"
Square Radius
Square Tapered
Diameter Tapered
Safari

\$ 1,275
\$ 1,275
\$ 1,419
\$ 1,544
\$ 1,550

Each Table Top is constructed using a 1" thick top with a Plastic Laminate top surface.
All Metal legs are coated electrostatically with an epoxy powder coat paint.

NOTES:

* Table heights of 25" (children), 27" (youth), and 32" (wheelchair) are available by request.
* Color of Metal Paint must be specified at the time of order.



*Trio-Link Table Shape

with METAL Leg Option:
Square 48" 48" 29"
Square & Stem
Diameter
Diameter & Stem
Balloon

\$ 1,213
\$ 1,613
\$ 1,213
\$ 1,613
\$ 1,313

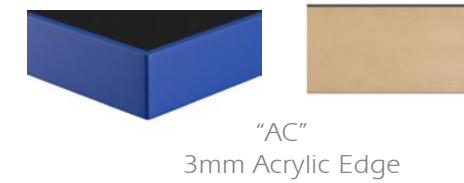
Edge Option:

"AC"
3mm Acrylic Edge

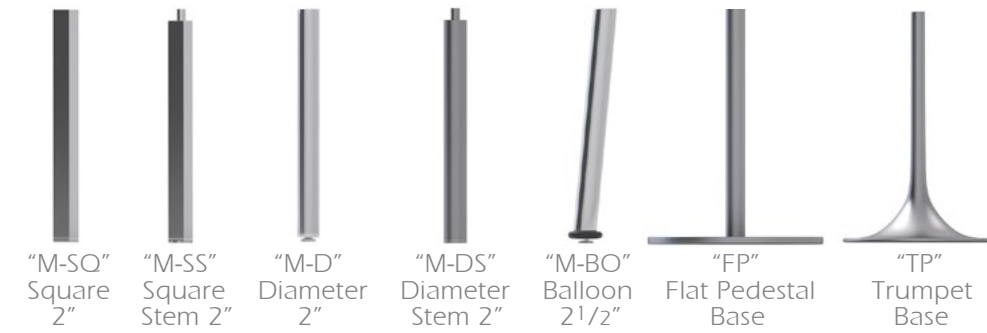
Metal Leg Options:

"M-SQ" Square 2"
"M-SS" Square Stem 2"
"M-D" Diameter 2"
"M-DS" Diameter Stem 2"
"M-BO" Balloon 2 1/2"
"FP" Flat Pedestal Base
"TP" Trumpet Base

\$ 2,400
\$ 2,400
\$ 2,494
\$ 1,644
\$ 1,644
\$ 1,869

Wood Leg Options:

"W-SQ" Square 2 3/8"
"W-SQR" Square Radius 2 3/8"
"W-SQT" Square Tapered 2 3/8"
"W-DT" Diameter Tapered 2 3/8"
"W-SR" Safari 2 3/8"

MODEL NUMBER

PRODUCT

WIDTH DEPTH HEIGHT

PRICE

DESCRIPTION



*Shown Above:
TB-TL60-AC-M-D

Trio-Link Table, 60" Width,

60" 60" 29"

\$ 2,019

Each Table Top is constructed using a 1" thick top with a Plastic Laminate top surface.

ACRYLIC Edge;

All Metal legs are coated electrostatically with an epoxy powder coat paint.

with WOOD Leg Option:

60" 60" 29"

\$ 2,019

NOTES:

* Table heights of 25" (children), 27" (youth), and 32" (wheelchair) are available by request.

* Color of Metal Paint must be specified at the time of order.

- TB-TL60-AC-W-SQ Square
- TB-TL60-AC-W-SQR Square Radius
- TB-TL60-AC-W-SQT Square Tapered
- TB-TL60-AC-W-DT Diameter Tapered
- TB-TL60-AC-W-SR Safari

with METAL Leg Option:

60" 60" 29"

\$ 1,894

Edge Option:



"AC"
3mm Acrylic Edge

- TB-TL60-AC-M-SQ Square
- TB-TL60-AC-M-SS Square & Stem
- TB-TL60-AC-M-D Diameter
- TB-TL60-AC-M-DS Diameter & Stem
- TB-TL60-AC-M-BO Balloon

\$ 2,688

\$ 1,894

\$ 2,688

\$ 2,088

Metal Leg Options:



- "M-SQ" Square 2"
- "M-SS" Square Stem 2"
- "M-D" Diameter 2"
- "M-DS" Diameter Stem 2"
- "M-BO" Balloon 2 1/2"

Wood Leg Options:



- "W-SQ" Square 2 3/8"
- "W-SQR" Square Radius 2 3/8"
- "W-SQT" Square Tapered 2 3/8"
- "W-DT" Diameter Tapered 2 3/8"
- "W-SR" Safari 2 3/8"



*Trio-Link Table Shape

MODEL NUMBER
PRODUCT
WIDTH DEPTH HEIGHT
PRICE
DESCRIPTION

*Shown Above:
TB-QL36-AC-M-D

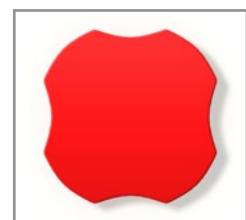

*Quad-Link Table Shape

TB-QL36-AC-W-SQ
TB-QL36-AC-W-SQR
TB-QL36-AC-W-SQT
TB-QL36-AC-W-DT
TB-QL36-AC-W-SR

Quad-Link Table, 36" Width,
ACRYLIC Edge;
with WOOD Leg Option:
Square
Square Radius
Square Tapered
Diameter Tapered
Safari

36" 36" 29"

\$ 1,269
\$ 1,269
\$ 1,456
\$ 1,619
\$ 1,625

TB-QL36-AC-M-SQ
TB-QL36-AC-M-SS
TB-QL36-AC-M-D
TB-QL36-AC-M-DS
TB-QL36-AC-M-BO
TB-QL36-AC-MC-SQ
TB-QL36-AC-MC-SS
TB-QL36-AC-MC-D
TB-QL36-AC-MC-DS

with METAL Leg Option:
Square
Square & Stem
Diameter
Diameter & Stem
Balloon
Square with Casters
Square & Stem with Casters
Diameter with Casters
Diameter & Stem with Casters

36" 36" 29"

\$ 1,188
\$ 1,713
\$ 1,188
\$ 1,713
\$ 1,313
\$ 1,469
\$ 1,913
\$ 1,469
\$ 1,913

TB-QL36-AC-FP1
TB-QL36-AC-FP2
TB-QL36-AC-FP3
TB-QL36-AC-TP1
TB-QL36-AC-TP2
TB-QL36-AC-TP3

Flat Pedestal 19" H
Flat Pedestal 29" H
Flat Pedestal 42" H
Trumpet 19" H
Trumpet 29" H
Trumpet 42" H

36" 36" 19"
36" 36" 29"
36" 36" 42"
36" 36" 19"
36" 36" 29"
36" 36" 42"

\$ 1,638
\$ 1,638
\$ 1,875
\$ 1,288
\$ 1,288
\$ 1,750

Each Table Top is constructed using a 1" thick top with a Plastic Laminate top surface.

All Metal legs are coated electrostatically with an epoxy powder coat paint.

NOTES:

- * Table heights of 25" (children), 27" (youth), and 32" (wheelchair) are available by request.
- * Color of Metal Paint must be specified at the time of order.
- * Caster Leg options are recommended for Reading/Multipurpose Tables options and not meant to be used for stationary computer workstations.
- * For all tables with casters legs, only 2 legs will have casters, and the other legs will have levelers. This will create a "wheelbarrow" style of table which will ensure ease of mobility.
- * Color of the Caster Option must be specified at the time of order.

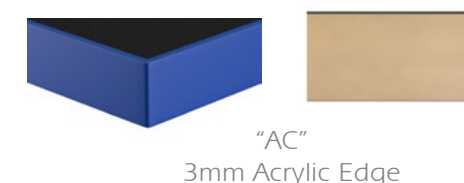
Edge Option:

"AC"
3mm Acrylic Edge

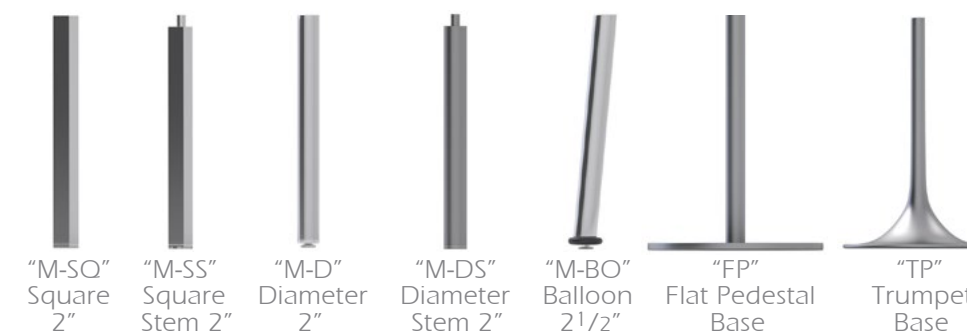
Metal Leg Options:

"M-SQ" Square 2"
"M-SS" Square Stem 2"
"M-D" Diameter 2"
"M-DS" Diameter Stem 2"
"M-BO" Balloon 2 1/2"
"FP" Flat Pedestal Base
"TP" Trumpet Base

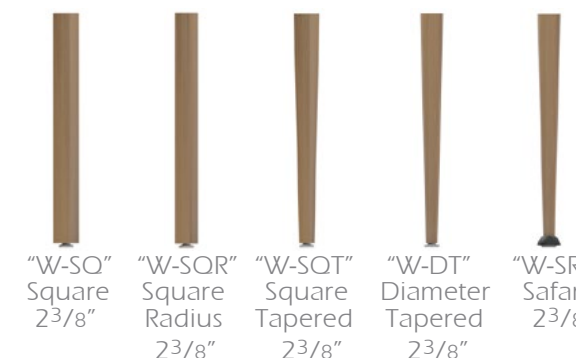
Wood Leg Options:

"W-SQ" Square 2 3/8"
"W-SQR" Square Radius 2 3/8"
"W-SQT" Square Tapered 2 3/8"
"W-DT" Diameter Tapered 2 3/8"
"W-SR" Safari 2 3/8"



"MC" Caster Option:
Available on all Metal Legs ONLY, with exception of the Balloon leg and Metal Bases.

MODEL NUMBER

PRODUCT

WIDTH DEPTH HEIGHT

PRICE

DESCRIPTION



- TB-QL42-AC-W-SQ
- TB-QL42-AC-W-SQR
- TB-QL42-AC-W-SQT
- TB-QL42-AC-W-DT
- TB-QL42-AC-W-SR

Quad-Link Table, 42" Width,
ACRYLIC Edge;
with WOOD Leg Option:
Square
Square Radius
Square Tapered
Diameter Tapered
Safari

42" 42" 29"

- \$ 1,331
- \$ 1,331
- \$ 1,525
- \$ 1,688
- \$ 1,694

Each Table Top is constructed using a 1" thick top with a Plastic Laminate top surface.
All Metal legs are coated electrostatically with an epoxy powder coat paint.
NOTES:
* Table heights of 25" (children), 27" (youth), and 32" (wheelchair) are available by request.
* Color of Metal Paint must be specified at the time of order.
* Caster Leg options are recommended for Reading/Multipurpose Tables options and not meant to be used for stationary computer workstations.
* For all tables with casters legs, only 2 legs will have casters, and the other legs will have levelers. This will create a "wheelbarrow" style of table which will ensure ease of mobility.
* Color of the Caster Option must be specified at the time of order.

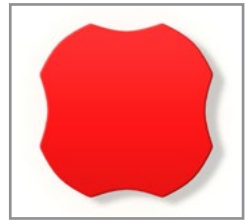

- TB-QL42-AC-M-SQ
- TB-QL42-AC-M-SS
- TB-QL42-AC-M-D
- TB-QL42-AC-M-DS
- TB-QL42-AC-M-BO
- TB-QL42-AC-MC-SQ
- TB-QL42-AC-MC-SS
- TB-QL42-AC-MC-D
- TB-QL42-AC-MC-DS

with METAL Leg Option:
Square
Square & Stem
Diameter
Diameter & Stem
Balloon
Square with Casters
Square & Stem with Casters
Diameter with Casters
Diameter & Stem with Casters

42" 42" 29"

- \$ 1,250
- \$ 1,781
- \$ 1,250
- \$ 1,781
- \$ 1,381
- \$ 1,531
- \$ 2,063
- \$ 1,531
- \$ 2,063

Edge Option:

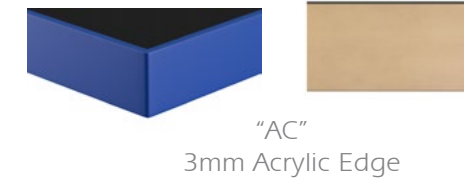

Metal Leg Options:



Wood Leg Options:

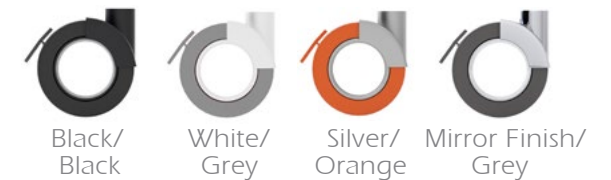
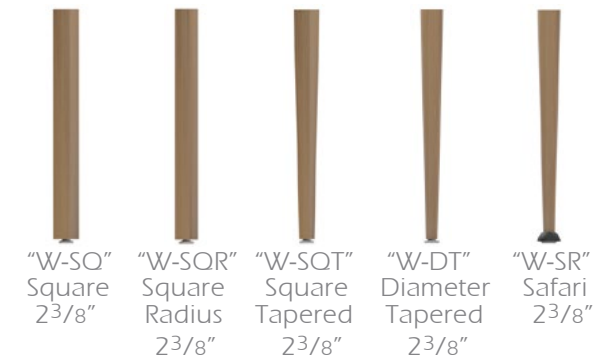

"MC" Caster Option:
Available on all Metal Legs ONLY, with exception of the Balloon leg and Metal Bases.

MODEL NUMBER

PRODUCT

WIDTH DEPTH HEIGHT

PRICE

DESCRIPTION



- TB-QL48-AC-W-SQ
- TB-QL48-AC-W-SQR
- TB-QL48-AC-W-SQT
- TB-QL48-AC-W-DT
- TB-QL48-AC-W-SR

Quad-Link Table, 48" Width,
ACRYLIC Edge;
with WOOD Leg Option:
Square
Square Radius
Square Tapered
Diameter Tapered
Safari

48" 48" 29"

- \$ 1,406
- \$ 1,406
- \$ 1,594
- \$ 1,756
- \$ 1,763

Each Table Top is constructed using a 1" thick top with a Plastic Laminate top surface.
All Metal legs are coated electrostatically with an epoxy powder coat paint.
NOTES:
* Table heights of 25" (children), 27" (youth), and 32" (wheelchair) are available by request.
* Color of Metal Paint must be specified at the time of order.
* Caster Leg options are recommended for Reading/Multipurpose Tables options and not meant to be used for stationary computer workstations.
* For all tables with casters legs, only 2 legs will have casters, and the other legs will have levelers. This will create a "wheelbarrow" style of table which will ensure ease of mobility.
* Color of the Caster Option must be specified at the time of order.

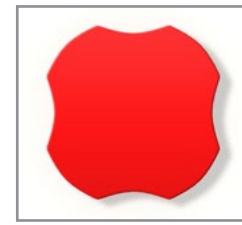

- TB-QL48-AC-M-SQ
- TB-QL48-AC-M-SS
- TB-QL48-AC-M-D
- TB-QL48-AC-M-DS
- TB-QL48-AC-M-BO
- TB-QL48-AC-MC-SQ
- TB-QL48-AC-MC-SS
- TB-QL48-AC-MC-D
- TB-QL48-AC-MC-DS

with METAL Leg Option:
Square
Square & Stem
Diameter
Diameter & Stem
Balloon
Square with Casters
Square & Stem with Casters
Diameter with Casters
Diameter & Stem with Casters

48" 48" 29"

- \$ 1,325
- \$ 1,850
- \$ 1,325
- \$ 1,850
- \$ 1,450
- \$ 1,606
- \$ 2,138
- \$ 1,606
- \$ 2,138

Edge Option:

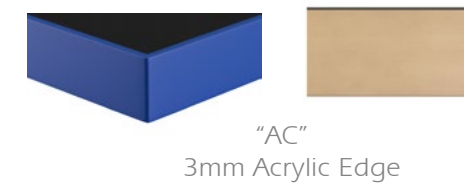

Metal Leg Options:



Wood Leg Options:

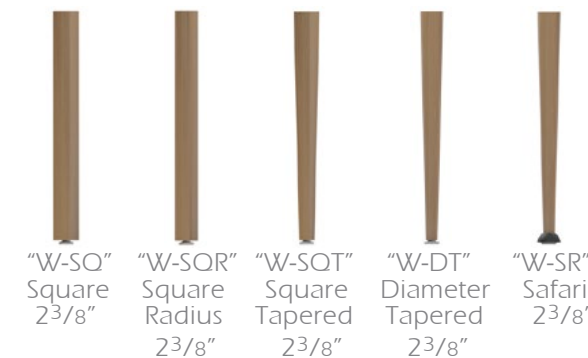

"MC" Caster Option:
Available on all Metal Legs ONLY, with exception of the Balloon leg and Metal Bases.

MODEL NUMBER	PRODUCT	WIDTH	DEPTH	HEIGHT
--------------	---------	-------	-------	--------



*Shown Above:
TB-QL60-AC-M-D

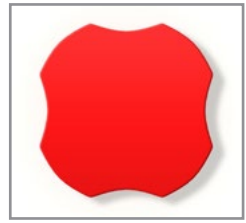

*Quad-Link Table Shape

	Quad-Link Table, 60" Width, ACRYLIC Edge;	60"	60"	29"
	with WOOD Leg Option:	60"	60"	29"
TB-QL60-AC-W-SQ	Square			
TB-QL60-AC-W-SQR	Square Radius			
TB-QL60-AC-W-SQT	Square Tapered			
TB-QL60-AC-W-DT	Diameter Tapered			
TB-QL60-AC-W-SR	Safari			
	with METAL Leg Option:	60"	60"	29"
TB-QL60-AC-M-SQ	Square			
TB-QL60-AC-M-SS	Square & Stem			
TB-QL60-AC-M-D	Diameter			
TB-QL60-AC-M-DS	Diameter & Stem			
TB-QL60-AC-M-BO	Balloon			
TB-QL60-AC-MC-SQ	Square with Casters			
TB-QL60-AC-MC-SS	Square & Stem with Casters			
TB-QL60-AC-MC-D	Diameter with Casters			
TB-QL60-AC-MC-DS	Diameter & Stem with Casters			

PRICE	DESCRIPTION
-------	-------------

	Each Table Top is constructed using a 1" thick top with a Plastic Laminate top surface.
	All Metal legs are coated electrostatically with an epoxy powder coat paint.
	NOTES:
\$ 1,906	* Table heights of 25" (children), 27" (youth), and 32" (wheelchair) are available by request.
\$ 1,906	* Color of Metal Paint must be specified at the time of order.
\$ 2,144	* Caster Leg options are recommended for Reading/Multipurpose Tables options and not meant to be used for stationary computer workstations.
\$ 2,344	* For all tables with casters legs, only 2 legs will have casters, and the other legs will have levelers. This will create a "wheelbarrow" style of table which will ensure ease of mobility.
\$ 2,356	* Color of the Caster Option must be specified at the time of order.
\$ 1,806	
\$ 2,469	
\$ 1,806	
\$ 2,469	
\$ 1,963	
\$ 2,163	
\$ 2,819	
\$ 2,163	
\$ 2,819	

Edge Option:

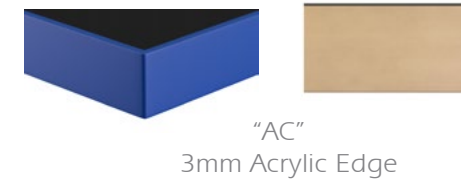

"AC"
3mm Acrylic Edge

Metal Leg Options:

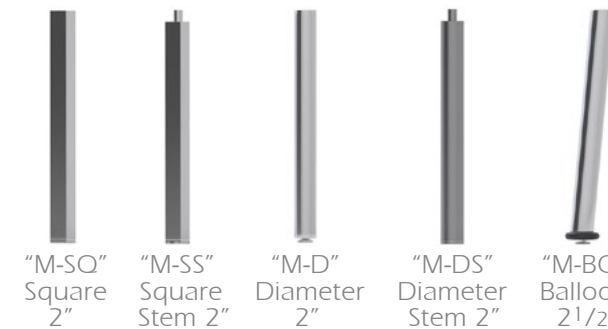

"M-SQ" Square 2"
"M-SS" Square Stem 2"
"M-D" Diameter 2"
"M-DS" Diameter Stem 2"
"M-BO" Balloon 2 1/2"

Wood Leg Options:

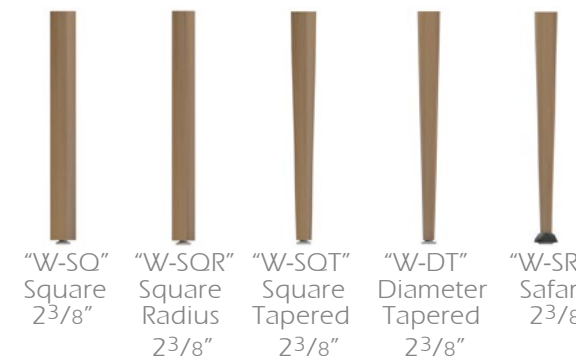

"W-SQ" Square 2 3/8"
"W-SQR" Square Radius 2 3/8"
"W-SQT" Square Tapered 2 3/8"
"W-DT" Diameter Tapered 2 3/8"
"W-SR" Safari 2 3/8"

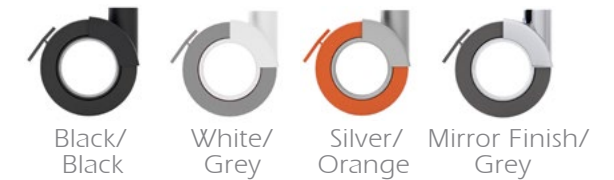

"MC" Caster Option:
Available on all Metal Legs ONLY, with exception of the Balloon leg and Metal Bases.

Palmieri Furniture Limited ("Palmieri") warrants that its products and collections are free from defects in materials and workmanship for the life of the product, except as set forth below. Palmieri Limited Lifetime Warranty is valid from the date of delivery.

Exceptions to the Limited Lifetime Warranty: Seating: two (2) years

Goods sold hereunder are covered by a Limited Lifetime Warranty, free against defects in material and workmanship provided the goods and services are subjected to normal use and service. The applicable warranty period commences from shipping date to Purchaser of any item of the goods, whichever occurs first, or any other warranty period otherwise stipulated in writing by Palmieri under this sale. For components not supplied by Palmieri, the original manufacturer's warranty shall apply to the extent assignable by Palmieri. The obligation under this warranty is limited to the repair or replacement, at Palmieri's option, of defective parts F.O.B. point of shipment provided that prompt notice of any defect is given by Purchaser to Palmieri in writing within the applicable warranty period and that upon the Purchaser's return of the defective parts to Palmieri or, if designated by Palmieri, to the location where the works are made, properly packed and with transportation charges prepaid by Purchaser, an inspection thereof shall reveal to Palmieri's satisfaction that Purchaser's claim is valid under the terms of this warranty. Purchaser shall assume all responsibility and expense for dismantling, removal, re-installation and freight in connection with the foregoing. The same obligations and conditions extend to replacement parts furnished by Palmieri hereunder.

Palmieri does not assume liability for installation, labour or consequential damages. Palmieri makes no warranty other than the one set forth herein. All other warranties, legal, expressed or implied, including but not limited to any expressed or implied warranty of merchantability, of fitness for the intended use thereof or against infringement are hereby expressly excluded. The applicable warranty ceases to be effective if the goods are altered or repaired other than by persons authorized or approved by Palmieri to perform such work. Repairs or replacement deliveries do not interrupt or prolong the term of the warranty. The warranty ceases to be effective if Purchaser fails to handle and use the goods sold hereunder in a safe and reasonable manner and in accordance with any written instructions from the manufacturers.

Warranty Does Not Apply To Product Failure Or Loss Resulting From:

Abuse, misuse or accident, alteration or modification of product by customer or third party, normal wear and tear, improper installation, handling or incorrect use. The substitution of part components or hardware not approved or authorized by Palmieri, acts of God, unauthorized repairs, improper storage, and environmental conditions such as irregular temperature control either inside or outside the environment.

Warranty Provides Exclusive Remedies:

If a product fails under ordinary use as a result of a defect in material or workmanship, Palmieri will: (A) repair, or (B) replace the furniture. The replacement or repair of the Furniture or Seating will be at the discretion of Palmieri. If the defect or workmanship cannot be remedied on site, repairs can be made at the factory. (C) If the product repair or replacement is not commercially practicable or cannot be remade in a timely manner Palmieri will refund the purchase price of the affected product. A product "**Defect**" means: an inadequacy in the materials or workmanship of the product that (A) existed at the time when you received the product from Palmieri or Palmieri authorized Reseller and (B) causes a failure of the product to perform under ordinary use in accordance with the materials and documentation accompanying the product. "**Ordinary Use**" means: use of the product (A) in accordance with all applicable local, state or federal laws, codes and regulations and (B) in accordance with manufacturer recommendations and or instructions in the materials and documentation accompanying the product or through shop drawings. A "**Palmieri Authorized Reseller**" means: any dealer that is legally permitted to conduct business in the jurisdiction where the product is sold and is duly authorized by Palmieri to sell the product.

Warranty work must be approved by authorized personnel of Palmieri Furniture Limited in Richmond Hill, Ontario, Canada.

A copy of the original purchase order must accompany all claims.

Warranty Does Not Cover:

Matching of colours, stains, textures, grains and any other variations in materials. Select and Custom Surfaces and materials are only warranted for their application on the specified product and are not covered by our warranty, except as warranted by the original supplier, for quality, colorfastness, shade variations or abrasion and textiles purchased for Palmieri product.

This limited warranty is the sole remedy for product defect and no other express or implied warranty is provided. Warranty is not transferable and valid only for the original purchaser acquiring a product from Palmieri or a Palmieri authorized reseller for the purchaser's own use and not for resale, remarketing or distribution. Limited Lifetime Warranty (25 years)

GENERAL

The following Terms and Conditions of Quote and Sale shall apply to any sale of goods and services by Palmieri Furniture Limited (hereinafter called "Palmieri"). Purchaser shall be deemed to have full knowledge of the terms and conditions herein and such terms and conditions shall be binding if either the goods and services referred to herein are delivered to and accepted by Purchaser, or if Purchaser does not within five (5) days from the date hereof deliver to Palmieri written objection to said terms and conditions or any part thereof.

In the event of any conflict or inconsistency between the terms and conditions of sale herein and the terms and conditions contained in Purchaser's order or in any other form issued by Purchaser, whether or not any such form has been acknowledged or accepted by Palmieri, Palmieri's terms and conditions herein shall prevail. No waiver, alteration or modification of these terms and conditions shall be binding upon Palmieri unless made in writing and signed by a duly authorized representative of Palmieri.

1. QUOTATIONS / PRODUCT QUOTED

Unless otherwise stated, **Palmieri's quotations shall be null and void unless accepted by Purchaser within thirty (30) days from the date of quotation.** Quotes may be subject to change before order placement, due to increased material costs and or other factors that could impact the final cost of production and our final understanding of the product required. If the items quoted do not reflect the intended product requirements of the customer, Palmieri will not be held responsible for increased costs for those product changes. We reserve the right to edit or re-quote any portion of a previously submitted quotation subject to our final understanding of the product required by the client.

2. PALMIERI DRAWINGS

Palmieri provides drawings for Custom & Standard product we produce to our clients upon request. We consider these drawings to be Private and Confidential and are provided for the sole purpose and use of our clients to understand the product we are providing. The use of these confidential materials is limited to the transaction between the parties and at no point are these confidential materials to be sent to any of our competitors or parties quoting for the same purpose.

A minimum \$85.00 NET Engineering Administrative Fee will apply for Custom Product Drawings

(Note: The first set of Custom product drawings will be free of charge)

A minimum \$120.00 NET Engineering Administrative Fee will apply for all Standard Product Drawings

3. TERMS OF PAYMENT

For authorized customers; Orders at a \$75,000.00 threshold will require a mandatory 25% deposit. Orders over and above \$100,000.00 requires a mandatory (25%) deposit at time of order, a mandatory (25%) deposit prior to product shipment and the balance to be paid within thirty (30) days of date of shipment. Payment not be made to Palmieri when due, Palmieri reserves the right to charge Purchaser with interest on such overdue payments. Interest of 2% per month (24% per annum) is charged on all overdue accounts, unless otherwise specified. The charging of such interest shall not be construed as obligating Palmieri to grant any extension of time in the terms of payment. All goods remain the property of Palmieri, until balance is paid in full to Palmieri.

4. TITLE

Title to the goods or any part thereof shall not pass from Palmieri to Purchaser until all payments due hereunder have been duly made, except as otherwise expressly stipulated herein. The goods shall be and remain personal or moveable property, notwithstanding their mode of attachment to realty or other property. If default is made in any of the payments herein, Purchaser agrees that Palmieri may retain all payments which have been made on account of the purchase price as liquidated damages, and Palmieri shall be free to enter the premises where the goods may be located and remove them as Palmieri's property, without prejudice to Palmieri's right to recover any further expenses or damages Palmieri may suffer by reason of such nonpayment.

5. TAXES

Prices do not include Goods & Services Tax, Provincial or Municipal sales, use, value-added or similar tax. All applicable taxes are extra. Our Harmonized Sales Tax (HST) registration number is R104055066.

6. THE AGREEMENT

An acceptance and official confirmation of Purchasers' order by signing Palmieri's Order Confirmation the Purchaser therefore is accepting terms and conditions as expressed herein Palmieri's Terms and Conditions of Quote and Sale by Palmieri and shall constitute the complete agreement, subject to the terms and conditions of sale herein set forth, and shall supersede all previous quotations, orders or agreements.

7. LEAD TIME / DELIVERY / DELAYS

Lead time is determined only when final material/finish selection and drawing approvals are received by Palmieri from the client. The accuracy of Palmieri's lead times, is created to the best of our ability with the information provided to us. Confirmed lead time is conveyed to the client by means of Order Confirmation. They do not preclude the client from checking the accuracy of your requirement and our Order Confirmation. Any noted discrepancies are to be reported immediately to Palmieri Customer Service Department for correction and re-issue of revised Order Confirmation. By signing and dating the Order Confirmation the client accepts the terms and conditions of quote and sale.

Lead time on our Order Confirmation do not account for delays that could potentially occur for special materials specified by the client that are outside of our standard finishes and materials program that are out of our control

and will affect the lead time on the order. Palmieri will notify the client immediately when these delays occur and adjust the lead time accordingly.

Delivery schedules are approximate and are based on prevailing market conditions applicable respectively at the time of Palmieri's quotation and Palmieri's acceptance of clients' order, if certain portions of an order are completed by the quoted lead time while other portions have experienced delays outside of our control. The client may choose to part ship the order at their discretion and expense. Otherwise the entire order will ship with the delayed portion at a later date. Palmieri may extend delivery schedules or may, at its option, cancel Purchaser's order in full or in part without liability other than to return any deposit or prepayment which is unearned by reason of the cancellation.

8. CHANGES AND CANCELLATION

Orders accepted by Palmieri are not subject to changes or cancellation by Purchaser without the written consent of Palmieri. In such cases where Palmieri authorizes changes or cancellation, Palmieri reserves the right to charge the Purchaser with reasonable costs based upon expenses already incurred and commitments made by Palmieri, including, without limitation, any labour done, material purchased and also including Supplier's usual overhead and reasonable profit and cancellation charges from Palmieri's suppliers. Palmieri will communicate to the Purchaser additional costs incurred by way of Revised Order Confirmation. Revised Order Confirmation will include applicable costs incurred and modification to lead times (if applicable). The Purchaser must provide Palmieri written confirmation of additional costs, before any changes can be processed on the order.

A minimum charge of \$100.00 NET Change Order Request fee will apply

A minimum charge of \$150.00 NET Cancel Order Request fee will apply.

9. SHIPPING LOCATION / SHIPPING QUOTES / COST OF TRANSPORTATION

Unless otherwise stated, all prices are F.O.B. our factory in Richmond Hill, Ontario, Canada.

Customary methods of transportation shall be selected by Palmieri and such transportation will be at Purchaser's expense. Shipping quotations are made at time of furniture quotation and are outside the control of Palmieri. **Shipping quotes are valid for ten (10) business days from the time of quote.** We do our best to maintain shipping costs as quoted, however all shipping weights and cubic feet shown are approximate only, various construction materials and packaging methods may add to the weights given. All quoted prices, unless otherwise stated on the quotation, are based on the current exchange rates, tariffs, fuel surcharges and costs of manufacture and are subject to change by Palmieri with or without notice until Purchaser's acceptance. Palmieri does not assume responsibility or liability for shipping costs, product during transit, or variances from the shipping weights or cubic feet shown in our specification guides. Special methods of transportation will be used upon Purchaser's request and at Purchaser's additional expense, provided reasonable notice of Purchaser's transportation requirements are given by Purchaser to Palmieri prior to shipment. Palmieri will notify the client prior to shipping product if shipping costs as quoted change, at which point the client must approve the adjusted shipping costs.

10. RECEIVING PRODUCT / REPORTING DAMAGE / STORAGE OF PRODUCT

Upon receipt of Palmieri product, the receiver of the goods must immediately inspect the product to ensure it is free of shipping damage. If the product is deemed in good order, the receiver of the product must ensure

to sign off on the accompanying carriers Bill of lading in good condition. Except for obligations stated under "Warranty" herein, Palmieri's responsibility for the product ceases once the product has been received and signed off in good order and is the full responsibility of the receiver and subsequently the owner.

In the event shipping damage is discovered during receipt of shipment, it is the responsibility of the receiver to ensure all noted damage is recorded on the carrier's Bill of Lading prior to sign off. All noted shipping damage claims must be reported to Palmieri within **24 hours** of receipt of the product onsite, failure to do so will result in the claim being deemed null and void. All shipping damage claims are to be reported directly to Palmieri's Shipping Manager. Please call our toll free number at **1-800-413-4440 ext. 33** or submit the claim by Fax directly to **1-905-731-9878**. Palmieri will not accept any shipping damage claims submitted **after 24 hours** and it shall be conclusively presumed that the goods were delivered in good condition.

Storage of product, Palmieri will not be held responsible for any potential damages or shortages for product shipped and received by Purchaser and is subsequently placed into storage and not inspected within 24 hours of receipt.

11. INSTALLATION / SHORTAGES / BACK CHARGES

Unless otherwise expressly stipulated, the goods shall be installed by and at the risk and expense of Purchaser.

In the event that Palmieri is requested to supervise such installation, Palmieri's responsibility shall be limited to exercising that degree of skill customary in the trade in supervising installations of the same type. Purchaser shall remain responsible for all other aspects of the work including compliance with the local regulations. It is the responsibility of the Purchaser to ensure hardware and parts are received in good order. Packing slip and hardware list to be provided by Palmieri with every order at time of shipping. Purchaser has the responsibility to notify Palmieri immediately without delay of issues that arise; subsequently Palmieri will take action to provide prompt resolution.

Shortages must be reported to Palmieri within **24 hours** of receipt of the goods and failure to do so may be at the expense of the Purchaser.

If deemed missing hardware and parts short shipped from the factory, Palmieri will arrange to ship freight prepaid to destination. Palmieri will only be responsible for replacement costs of missing hardware and parts, any labour costs incurred will be the responsibility of the Purchaser and will not be approved by Palmieri.

Back Charges will only be approved if we deemed a defect in the material or workmanship is found during the installation period resulting in a return trip to the job-site to complete installation. It shall remain the sole discretion of Palmieri to approve (A) repair or (B) replace the furniture and any labour costs incurred by the Purchaser.

12. FORCE MAJEURE

Palmieri shall not be responsible or liable for any loss or damage incurred by Purchaser herein resulting from causes beyond the reasonable control of Palmieri including, but without limitation, abuse, misuse or accident, alteration or modification of product by customer or third party, normal wear and tear, improper installation, handling or incorrect use, unauthorized repairs, the substitution of part components or hardware not approved or authorized by Palmieri, improper storage, and environmental conditions such as irregular temperature control

either inside or outside the environment, acts of God, fire, flood, delays in transportation, or the failure of Palmieri's suppliers to meet their delivery promises. The acceptance of delivery of the goods by Purchaser shall constitute a waiver of all claims for loss or damage due to any delay whatsoever.

13. RETURNED GOODS

No goods may be returned to Palmieri for a credit or exchanged without Palmieri's prior written consent.

Palmieri reserves the right to accept all returns and subject to a handling/restocking charge or to decline all returns. Even after Palmieri has authorized the return of goods for credit, Palmieri reserves the right to adjust the amount of any credit given to Purchaser on return of the goods based on the conditions of the goods on arrival in Palmieri's warehouse. Credit for returned goods will be issued to Purchaser only where such goods are returned by Purchaser and not by any subsequent owner of the goods. Goods will be considered for return only if they are in their original condition and packaging. Palmieri Goods Return Authorization Form to be issued and **must** accompany all shipments returning back to the factory. **Return freight must be prepaid by Purchaser. A minimum 20% re-stocking fee will apply.**

1230 Reid Street | T 905 731 9300
Richmond Hill | F 905 731 9878
Ontario Canada | TF 800 413 4440
L4B 1C4 | info@palmierifurniture.com
www.PalmieriFurniture.com















SPECIFICATION GUIDE & PRICE LIST

2017

PALMIERI

NAVIGATE

CATEGORY: LIBRARY FURNITURE
CONTRACT: BID #ESCNJ 17/18-16

Table of Contents	2-3		
Product Materials & Finishes	4-7		
4100 Series	8-9		
4200 Series	10-11		
4300 Series	12-13		
4400 Series	14-15		
4500 Series	16-17		
4600 Series	18-19		
4700 Series	20-21		
4800 Series	22-23		
		5100 Series	24-25
			
		6100 Series	26-27
			
		7101 Series	26-27
			
		8100 Series	28-29
			
		8200 Series	28-29
			
		9100 Series	30-31
			
		9200 Series	30-31
			
		Warranty	32
		Terms & Conditions	33

METAL PAINT:

Thermal Paint Colours



EDGE BAND COLOURS:

PVC edge band colour options



HARDWOODS: All hardwood materials used in the manufacturing of Palmieri products shall be Northern grown hardwoods. Hardwoods will be air and kiln dried to a moisture content of 5-7%. All hardwoods shall be of grade "A" material, free of material stains, imperfections, conformity of grain, texture and color. Hardwood species shall be Northern grown Red Oak, Clear White Northern Maple and Birch. American Cherry and Honduras Mahogany and Walnut are available. Please inquire for pricing.

VENEER: Exposed face veneers shall be not less than 1/28" thick plain sliced veneers. Veneers are to be selected for conformity of grain direction and color. Veneers are to be stitched tightly in a book match, slip match or plain sliced configuration. Unexposed veneers are to be of hardwood but not selected for color, or grain quality. Veneers are not to be lap joined or reveal any tape or glue lines.

PARTICLE BOARD CORE: The particleboard shall be formed of wood chips, bonded with a water resistance adhesive. The particleboard material is to be of a high density 45 lbs/cu. ft. having a minimum average modulus of rupture of 2400 psi and a minimum average modulus of elasticity of 4,000,000 psi.

VENEER CORE: Veneer core is to be constructed with odd numbers of plies. Each ply is to be laminated in pairs and cross banded in opposite directions with grain direction at a 90 degree angle to the grain of the center core. All plies are to be free from knots, wrinkles, laps or other natural or manufacturing defects.

LUMBER CORE: Lumber core is to be of the highest quality grade. Grade "A" select stock. Lumber core shall be constructed of solid random width strips not less than 2" wide nor more than 3 1/2" wide by 1" thick. Wood strips will be free from knots or other defects. All strips will be tightly joined using water resistance adhesives.





HIGH PRESSURE LAMINATE: Work surface laminate shall be .050" thick and used with balancing backer sheet of no less than .028" thick. Laminate shall conform to standards set by the American Standards Institute/National Electrical Manufacturers Association (ANSI/NEMA) for thickness, performance and appearance. Printed colours, abstract patterns and wood grains are reproduced from representative segments of large sheets and may differ slightly from the actual product.

FINISHING PROCEDURES: All materials shall be inspected and treated with a final sanding and polishing operation before any staining and final finishing can be performed. All machine and mill marks are to be removed. Once the polishing and sanding has been performed, the furniture will then undergo the following stain and finishing procedures:

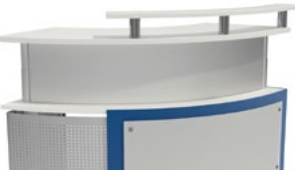

- Step 1 A base stain will be uniformly applied, wiped and then allowed to dry under factory controlled conditions.
- Step 2 A uniform coat of sealer will be applied and allowed to dry.
- Step 3 Sealer will be lightly sanded using 240 grit silicon paper.
- Step 4 A catalytic lacquer of 34-45 degree sheen is evenly applied and allowed to dry under factory controlled conditions.

METAL FINISHING PROCEDURES: All metal components are thoroughly cleaned and coated electrostatically with an epoxy powder coat paint finish. The metal components are then oven baked and cured for a lasting finish.

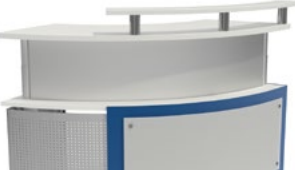

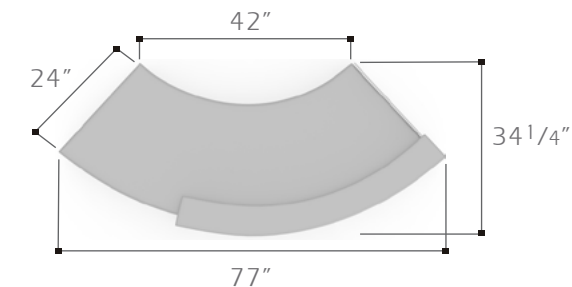

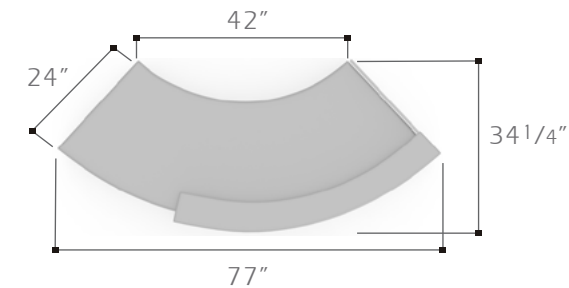

EDGE BANDS: All edge bands are manufactured in PVC, semi-rigid (Flex) and ABS. Standard edging size are normally 1.25" wide x 3 mm thick. These are made of the highest grade polymers and its materials are extensively tested prior to production using special test procedures and industry specification and quality standards.

	MODEL NUMBER	PRODUCT	WIDTH	LENGTH	HEIGHT TOP / OVERALL	PRICE	DESCRIPTION
		4100 Series; FIXED Unit Steel Panels, 6" Depth Patron Ledge, 3" Grommet, Wire Management;					WORK SURFACE & LEDGE: Tops are constructed of 1" thick 3-ply particleboard core. The Tops' surfaces are laminated with a .050" thick high pressure plastic laminate sheet and bottom surface laminated with a backing sheet not less than .020" thick for balanced construction. All edges will be banded with a 1/8" thick acrylic edge.
	NV-4100-L-F	LAMINATE Top & Ledge	34 1/4"	77"	30" / 36"	\$ 12,781	METAL ASSEMBLY: Metal components consists of a 16 gauge non-perforated main panel, a 16" gauge perforated return panel, and 2 1/2" diameter legs. As a standard the Main panel, Return panel and Legs will consist of ONE paint color option. Dual color combinations are available by request only. The application for Dual color finishes will be the following: Main panel with color #1, perforated return panel and legs with color #2.
	NV-4100-C-F	CUSTOM Top & Ledge				Inquire for Quote	
	NV-4100-L-F-S	STANDING UNIT, LAMINATE Top & Ledge	34 1/4"	77"	39" / 45"	\$ 14,312	
	NV-4100-C-F-S	STANDING UNIT, CUSTOM Top & Ledge				Inquire for Quote	CASTER (Unit 4101 only): The unit comes with a 4" diameter swivel caster with brake.
	NV-4100-L-F-HA	HEIGHT-ADJUSTABLE UNIT LAMINATE Top & Ledge	34 1/4"	77"	30-39" / 36-45"	\$ 18,906	DECORATIVE PANEL: The front of the unit has a 1/4" thick frosted acrylic panel with diameter stand-off hardware. For custom decorative acrylic panel, please inquire with Palmieri for pricing.
	NV-4100-C-F-HA	HEIGHT-ADJUSTABLE UNIT CUSTOM Top & Ledge				Inquire for Quote	NOTES: * Custom Top and Ledge materials may include Solid Surface, Quartz, or Natural Stone. * Standard work surface height is 30". Optional ADA height of 32" is available by request. * Metal Paint color(s) for the Panels and Legs must be specified at the time of order. * Grommet and Wire Management are included in price.
		4101 Series; MOBILE Unit 4" Casters Steel Panels, 6" Depth Patron Ledge, 3" Grommet, Wire Management;					
	NV-4101-L-M	LAMINATE Top & Ledge	34 1/4"	77"	30" / 36"	\$ 13,125	
	NV-4101-C-M	CUSTOM Top & Ledge				Inquire for Quote	
	NV-4101-L-M-S	STANDING UNIT, LAMINATE Top & Ledge	34 1/4"	77"	39" / 45"	\$ 14,656	
	NV-4101-C-M-S	STANDING UNIT, CUSTOM Top & Ledge				Inquire for Quote	
	NV-4101-L-M-HA	HEIGHT-ADJUSTABLE UNIT LAMINATE Top & Ledge	34 1/4"	77"	30-39" / 36-45"	\$ 19,250	
	NV-4101-C-M-HA	HEIGHT-ADJUSTABLE UNIT CUSTOM Top & Ledge				Inquire for Quote	









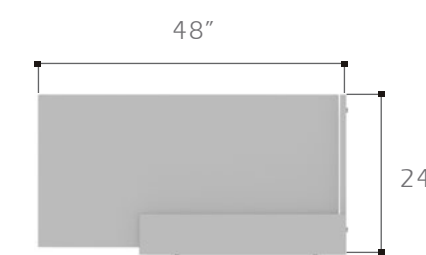



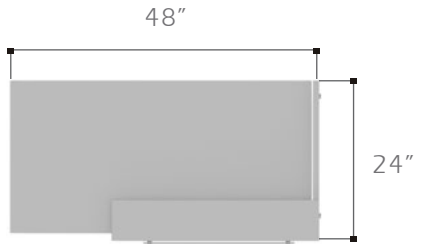

MODEL NUMBER	PRODUCT	WIDTH	LENGTH	HEIGHT TOP / OVERALL	PRICE	DESCRIPTION
	4200 Series; FIXED Unit Wood/Steel Panels, 6" Depth Patron Ledge, 3" Grommet, Wire Management;					
NV-4200-L-F	LAMINATE Top & Ledge	34 1/4"	77"	30" / 36"	\$ 13,775	WORK SURFACE & LEDGE: Tops are constructed of 1" thick 3-ply particleboard core. The Tops' surfaces are laminated with a .050" thick high pressure plastic laminate sheet and bottom surface laminated with a backing sheet not less than .020" thick for balanced construction. All edges will be banded with a 1/8" thick acrylic edge.
NV-4200-C-F	CUSTOM Top & Ledge				Inquire for Quote	METAL ASSEMBLY: Metal components consists of a 16 gauge perforated return panel, and 2 1/2" diameter legs. As a standard the Return panel and Legs will consist of ONE paint color option.
	STANDING UNIT, LAMINATE Top & Ledge	34 1/4"	77"	39" / 45"	\$ 15,306	WOOD PANEL: The main panel's construction consists of a 1" thick 4-ply particleboard core with plain sliced veneer both faces.
NV-4200-L-F-S					Inquire for Quote	CASTER (Unit 4201 only): The unit comes with a 4" diameter swivel caster with brake.
NV-4200-C-F-S						DECORATIVE PANEL: The front of the unit has a 1/4" thick frosted acrylic panel with diameter stand-off hardware. For custom decorative acrylic panel, please inquire with Palmieri for pricing.
NV-4200-L-F-HA	HEIGHT-ADJUSTABLE UNIT LAMINATE Top & Ledge	34 1/4"	77"	30-39" / 36-45"	\$ 19,900	
NV-4200-C-F-HA	HEIGHT-ADJUSTABLE UNIT CUSTOM Top & Ledge				Inquire for Quote	
	4201 Series; MOBILE Unit 4" Casters Wood/Steel Panels, 6" Depth Patron Ledge, 3" Grommet, Wire Management;					
NV-4201-L-M	LAMINATE Top & Ledge	34 1/4"	77"	30" / 36"	\$ 14,119	NOTES: * Custom Top and Ledge materials may include Solid Surface, Quartz, or Natural Stone. * Standard work surface height is 30". Optional ADA height of 32" is available by request. * Metal Paint color for the Return Panel and Legs must be specified at the time of order. * Grommet and Wire Management are included in price.
NV-4201-C-M	CUSTOM Top & Ledge				Inquire for Quote	
NV-4201-L-M-S	STANDING UNIT, LAMINATE Top & Ledge	34 1/4"	77"	39" / 45"	\$ 15,650	
NV-4201-C-M-S	STANDING UNIT, CUSTOM Top & Ledge				Inquire for Quote	
NV-4201-L-M-HA	HEIGHT-ADJUSTABLE UNIT LAMINATE Top & Ledge	34 1/4"	77"	30-39" / 36-45"	\$ 20,244	
NV-4201-C-M-HA	HEIGHT-ADJUSTABLE UNIT CUSTOM Top & Ledge				Inquire for Quote	





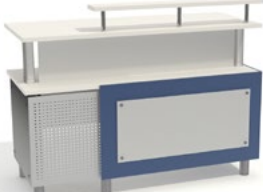



MODEL NUMBER	PRODUCT	WIDTH	LENGTH	HEIGHT TOP / OVERALL	PRICE	DESCRIPTION
	4300 Series; FIXED Unit 48" RECTANGULAR, Steel Panels, 6" Depth Patron Ledge, 3" Grommet, Wire Management; LAMINATE Top & Ledge	24"	48"	30" / 36"	\$ 6,411	<p>WORK SURFACE & LEDGE: Tops are constructed of 1" thick 3-ply particleboard core. The Tops' surfaces are laminated with a .050" thick high pressure plastic laminate sheet and bottom surface laminated with a backing sheet not less than .020" thick for balanced construction. All edges will be banded with a 1/8" thick acrylic edge.</p> <p>METAL ASSEMBLY: Metal components consists of a 16 gauge non-perforated main panel, a 16" gauge perforated return panel, and 2 1/2" diameter legs. As a standard the Main panel, Return panel and Legs will consist of ONE paint color option. Dual color combinations are available by request only. The application for Dual color finishes will be the following: Main panel with color #1, perforated return panel and legs with color #2.</p> <p>CASTER (Unit 4301 only): The unit comes with a 4" diameter swivel caster with brake.</p> <p>DECORATIVE PANEL: The front of the unit has a 1/4" thick frosted acrylic panel with diameter stand-off hardware. For custom decorative acrylic panel, please inquire with Palmieri for pricing.</p> <p>NOTES: * Custom Top and Ledge materials may include Solid Surface, Quartz, or Natural Stone. * Standard work surface height is 30". Optional ADA height of 32" is available by request. * Metal Paint color(s) for the Panels and Legs must be specified at the time of order. * Grommet and Wire Management are included in price.</p>
NV-4300-L-F	CUSTOM Top & Ledge				Inquire for Quote	
	STANDING UNIT, LAMINATE Top & Ledge	24"	48"	39" / 45"	\$ 7,179	
NV-4300-L-F-S	CUSTOM Top & Ledge				Inquire for Quote	
	STANDING UNIT, CUSTOM Top & Ledge	24"	48"	30-39" / 36-45"	\$ 9,483	
NV-4300-C-F-S	CUSTOM Top & Ledge				Inquire for Quote	
NV-4300-L-F-HA	HEIGHT-ADJUSTABLE UNIT LAMINATE Top & Ledge	24"	48"	30-39" / 36-45"	\$ 9,483	
NV-4300-C-F-HA	HEIGHT-ADJUSTABLE UNIT CUSTOM Top & Ledge				Inquire for Quote	
	4301 Series; MOBILE Unit 4" Casters, 48" RECTANGULAR, Steel Panels, 6" Depth Patron Ledge, 3" Grommet, Wire Management; LAMINATE Top & Ledge	24"	48"	30" / 36"	\$ 6,721	
NV-4301-L-M	CUSTOM Top & Ledge				Inquire for Quote	
	STANDING UNIT, LAMINATE Top & Ledge	24"	48"	39" / 45"	\$ 7,489	
NV-4301-L-M-S	CUSTOM Top & Ledge				Inquire for Quote	
	STANDING UNIT, CUSTOM Top & Ledge	24"	48"	30-39" / 36-45"	\$ 9,793	
NV-4301-L-M-HA	HEIGHT-ADJUSTABLE UNIT LAMINATE Top & Ledge	24"	48"	30-39" / 36-45"	\$ 9,793	
NV-4301-C-M-HA	HEIGHT-ADJUSTABLE UNIT CUSTOM Top & Ledge				Inquire for Quote	



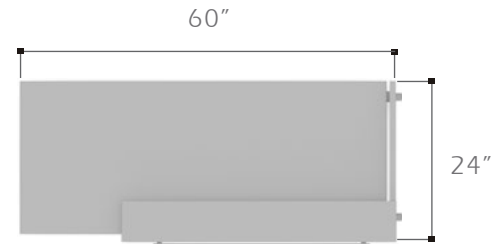







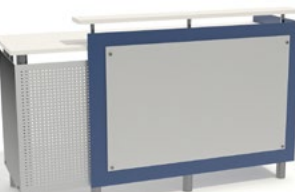

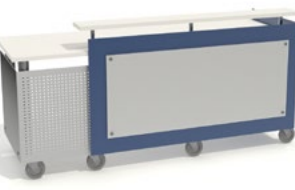
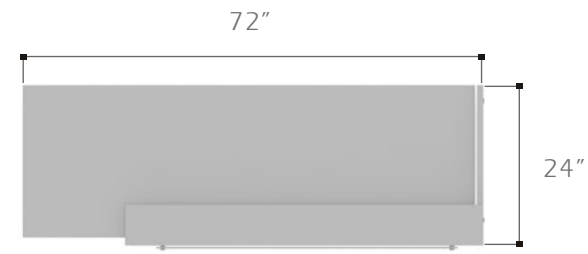
MODEL NUMBER	PRODUCT	WIDTH	LENGTH	HEIGHT TOP / OVERALL	PRICE	DESCRIPTION
	4400 Series; FIXED Unit 48" RECTANGULAR, Wood/Steel Panels, 6" Depth Patron Ledge, 3" Grommet, Wire Management; LAMINATE Top & Ledge	24"	48"	30" / 36"	\$ 6,924	WORK SURFACE & LEDGE: Tops are constructed of 1" thick 3-ply particleboard core. The Tops' surfaces are laminated with a .050" thick high pressure plastic laminate sheet and bottom surface laminated with a backing sheet not less than .020" thick for balanced construction. All edges will be banded with a 1/8" thick acrylic edge.
NV-4400-L-F						METAL ASSEMBLY: Metal components consists of a 16 gauge perforated return panel, and 2 1/2" diameter legs. As a standard the Return panel and Legs will consist of ONE paint color option.
NV-4400-C-F	CUSTOM Top & Ledge				Inquire for Quote	
	STANDING UNIT, LAMINATE Top & Ledge	24"	48"	39" / 45"	\$ 7,692	WOOD PANEL: The main panel's construction consists of a 1" thick 4-ply particleboard core with plain sliced veneer both faces.
NV-4400-L-F-S						
NV-4400-C-F-S	STANDING UNIT, CUSTOM Top & Ledge				Inquire for Quote	
	HEIGHT-ADJUSTABLE UNIT LAMINATE Top & Ledge	24"	48"	30-39" / 36-45"	\$ 9,996	CASTER (Unit 4401 only): The unit comes with a 4" diameter swivel caster with brake.
NV-4400-L-F-HA						DECORATIVE PANEL: The front of the unit has a 1/4" thick frosted acrylic panel with diameter stand-off hardware. For custom decorative acrylic panel, please inquire with Palmieri for pricing.
NV-4400-C-F-HA	HEIGHT-ADJUSTABLE UNIT CUSTOM Top & Ledge				Inquire for Quote	
						NOTES: * Custom Top and Ledge materials may include Solid Surface, Quartz, or Natural Stone. * Standard work surface height is 30". Optional ADA height of 32" is available by request. * Metal Paint color for the Return Panel and Legs must be specified at the time of order. * Grommet and Wire Management are included in price.
	4401 Series; MOBILE Unit 4" Casters, 48" RECTANGULAR, Wood/Steel Panels, 6" Depth Patron Ledge, 3" Grommet, Wire Management; LAMINATE Top & Ledge	24"	48"	30" / 36"	\$ 7,234	
NV-4401-L-M						
NV-4401-C-M	CUSTOM Top & Ledge				Inquire for Quote	
	STANDING UNIT, LAMINATE Top & Ledge	24"	48"	39" / 45"	\$ 8,002	
NV-4401-L-M-S						
NV-4401-C-M-S	STANDING UNIT, CUSTOM Top & Ledge				Inquire for Quote	
	HEIGHT-ADJUSTABLE UNIT LAMINATE Top & Ledge	24"	48"	30-39" / 36-45"	\$ 10,306	
NV-4401-L-M-HA						
NV-4401-C-M-HA	HEIGHT-ADJUSTABLE UNIT CUSTOM Top & Ledge				Inquire for Quote	

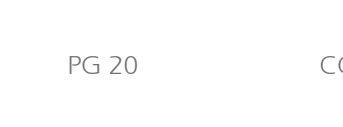

MODEL NUMBER	PRODUCT	WIDTH	LENGTH	HEIGHT TOP / OVERALL	PRICE	DESCRIPTION
	4500 Series; FIXED Unit 60" RECTANGULAR, Steel Panels, 6" Depth Patron Ledge, 3" Grommet, Wire Management; LAMINATE Top & Ledge	24"	60"	30" / 36"	\$ 7,893	<p>WORK SURFACE & LEDGE: Tops are constructed of 1" thick 3-ply particleboard core. The Tops' surfaces are laminated with a .050" thick high pressure plastic laminate sheet and bottom surface laminated with a backing sheet not less than .020" thick for balanced construction. All edges will be banded with a 1/8" thick acrylic edge.</p> <p>METAL ASSEMBLY: Metal components consists of a 16 gauge non-perforated main panel, a 16" gauge perforated return panel, and 2 1/2" diameter legs. As a standard the Main panel, Return panel and Legs will consist of ONE paint color option. Dual color combinations are available by request only. The application for Dual color finishes will be the following: Main panel with color #1, perforated return panel and legs with color #2.</p> <p>CASTER (Unit 4501 only): The unit comes with a 4" diameter swivel caster with brake.</p> <p>DECORATIVE PANEL: The front of the unit has a 1/4" thick frosted acrylic panel with diameter stand-off hardware. For custom decorative acrylic panel, please inquire with Palmieri for pricing.</p> <p>NOTES: * Custom Top and Ledge materials may include Solid Surface, Quartz, or Natural Stone. * Standard work surface height is 30". Optional ADA height of 32" is available by request. * Metal Paint color(s) for the Panels and Legs must be specified at the time of order. * Grommet and Wire Management are included in price.</p>
NV-4500-L-F	CUSTOM Top & Ledge				Inquire for Quote	
	STANDING UNIT, LAMINATE Top & Ledge	24"	60"	39" / 45"	\$ 8,838	
NV-4500-L-F-S	CUSTOM Top & Ledge				Inquire for Quote	
	STANDING UNIT, CUSTOM Top & Ledge	24"	60"	30-39" / 36-45"	\$ 11,676	
NV-4500-C-F-S	CUSTOM Top & Ledge				Inquire for Quote	
NV-4500-L-F-HA	HEIGHT-ADJUSTABLE UNIT LAMINATE Top & Ledge	24"	60"	30-39" / 36-45"	\$ 11,676	
NV-4500-C-F-HA	HEIGHT-ADJUSTABLE UNIT CUSTOM Top & Ledge				Inquire for Quote	
	4501 Series; MOBILE Unit 4" Casters, 60" RECTANGULAR, Steel Panels, 6" Depth Patron Ledge, 3" Grommet, Wire Management; LAMINATE Top & Ledge	24"	60"	30" / 36"	\$ 8,203	
NV-4501-L-M	CUSTOM Top & Ledge				Inquire for Quote	
	STANDING UNIT, LAMINATE Top & Ledge	24"	60"	39" / 45"	\$ 9,148	
NV-4501-L-M-S	CUSTOM Top & Ledge				Inquire for Quote	
	STANDING UNIT, CUSTOM Top & Ledge	24"	60"	30-39" / 36-45"	\$ 11,986	
NV-4501-L-M-HA	HEIGHT-ADJUSTABLE UNIT LAMINATE Top & Ledge	24"	60"	30-39" / 36-45"	\$ 11,986	
NV-4501-C-M-HA	HEIGHT-ADJUSTABLE UNIT CUSTOM Top & Ledge				Inquire for Quote	

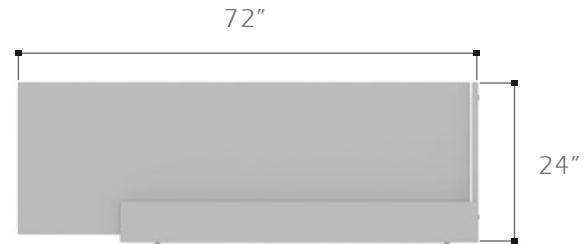

MODEL NUMBER	PRODUCT	WIDTH	LENGTH	HEIGHT TOP / OVERALL	PRICE	DESCRIPTION
	4600 Series; FIXED Unit 60" RECTANGULAR, Wood/Steel Panels, 6" Depth Patron Ledge, 3" Grommet, Wire Management; LAMINATE Top & Ledge	24"	60"	30" / 36"	\$ 8,406	<p>WORK SURFACE & LEDGE: Tops are constructed of 1" thick 3-ply particleboard core. The Tops' surfaces are laminated with a .050" thick high pressure plastic laminate sheet and bottom surface laminated with a backing sheet not less than .020" thick for balanced construction. All edges will be banded with a 1/8" thick acrylic edge.</p> <p>METAL ASSEMBLY: Metal components consists of a 16 gauge perforated return panel, and 2 1/2" diameter legs. As a standard the Return panel and Legs will consist of ONE paint color option.</p> <p>WOOD PANEL: The main panel's construction consists of a 1" thick 4-ply particleboard core with plain sliced veneer both faces.</p> <p>CASTER (Unit 4601 only): The unit comes with a 4" diameter swivel caster with brake.</p> <p>DECORATIVE PANEL: The front of the unit has a 1/4" thick frosted acrylic panel with diameter stand-off hardware. For custom decorative acrylic panel, please inquire with Palmieri for pricing.</p> <p>NOTES: * Custom Top and Ledge materials may include Solid Surface, Quartz, or Natural Stone. * Standard work surface height is 30". Optional ADA height of 32" is available by request. * Metal Paint color for the Return Panel and Legs must be specified at the time of order. * Grommet and Wire Management are included in price.</p> 
NV-4600-L-F	LAMINATE Top & Ledge	24"	60"	30" / 36"	\$ 8,406	
NV-4600-C-F	CUSTOM Top & Ledge				Inquire for Quote	
	STANDING UNIT, LAMINATE Top & Ledge	24"	60"	39" / 45"	\$ 9,351	
NV-4600-L-F-S	LAMINATE Top & Ledge	24"	60"	39" / 45"	\$ 9,351	
NV-4600-C-F-S	CUSTOM Top & Ledge				Inquire for Quote	
	HEIGHT-ADJUSTABLE UNIT LAMINATE Top & Ledge	24"	60"	30-39" / 36-45"	\$ 12,189	
NV-4600-L-F-HA	LAMINATE Top & Ledge	24"	60"	30-39" / 36-45"	\$ 12,189	
NV-4600-C-F-HA	CUSTOM Top & Ledge				Inquire for Quote	
	4601 Series; MOBILE Unit 4" Casters, 60" RECTANGULAR, Wood/Steel Panels, 6" Depth Patron Ledge, 3" Grommet, Wire Management; LAMINATE Top & Ledge	24"	60"	30" / 36"	\$ 8,716	
NV-4601-L-M	LAMINATE Top & Ledge	24"	60"	30" / 36"	\$ 8,716	
NV-4601-C-M	CUSTOM Top & Ledge				Inquire for Quote	
	STANDING UNIT, LAMINATE Top & Ledge	24"	60"	39" / 45"	\$ 9,661	
NV-4601-L-M-S	LAMINATE Top & Ledge	24"	60"	39" / 45"	\$ 9,661	
NV-4601-C-M-S	CUSTOM Top & Ledge				Inquire for Quote	
	HEIGHT-ADJUSTABLE UNIT LAMINATE Top & Ledge	24"	60"	30-39" / 36-45"	\$ 12,499	
NV-4601-L-M-HA	LAMINATE Top & Ledge	24"	60"	30-39" / 36-45"	\$ 12,499	
NV-4601-C-M-HA	CUSTOM Top & Ledge				Inquire for Quote	

MODEL NUMBER	PRODUCT	WIDTH	LENGTH	HEIGHT TOP / OVERALL	PRICE	DESCRIPTION
	4700 Series; FIXED Unit 72" RECTANGULAR, Steel Panels, 6" Depth Patron Ledge, 3" Grommet, Wire Management; LAMINATE Top & Ledge	24"	72"	30" / 36"	\$ 9,672	<p>WORK SURFACE & LEDGE: Tops are constructed of 1" thick 3-ply particleboard core. The Tops' surfaces are laminated with a .050" thick high pressure plastic laminate sheet and bottom surface laminated with a backing sheet not less than .020" thick for balanced construction. All edges will be banded with a 1/8" thick acrylic edge.</p> <p>METAL ASSEMBLY: Metal components consists of a 16 gauge non-perforated main panel, a 16" gauge perforated return panel, and 2 1/2" diameter legs. As a standard the Main panel, Return panel and Legs will consist of ONE paint color option. Dual color combinations are available by request only. The application for Dual color finishes will be the following: Main panel with color #1, perforated return panel and legs with color #2.</p> <p>CASTER (Unit 4701 only): The unit comes with a 4" diameter swivel caster with brake.</p> <p>DECORATIVE PANEL: The front of the unit has a 1/4" thick frosted acrylic panel with diameter stand-off hardware. For custom decorative acrylic panel, please inquire with Palmieri for pricing.</p> <p>NOTES: * Custom Top and Ledge materials may include Solid Surface, Quartz, or Natural Stone. * Standard work surface height is 30". Optional ADA height of 32" is available by request. * Metal Paint color(s) for the Panels and Legs must be specified at the time of order. * Grommet and Wire Management are included in price.</p>
NV-4700-L-F	CUSTOM Top & Ledge				Inquire for Quote	
	STANDING UNIT, LAMINATE Top & Ledge	24"	72"	39" / 45"	\$ 10,831	
NV-4700-L-F-S	CUSTOM Top & Ledge				Inquire for Quote	
	STANDING UNIT, CUSTOM Top & Ledge	24"	72"	30-39" / 36-45"	\$ 14,308	
NV-4700-L-F-HA	CUSTOM Top & Ledge				Inquire for Quote	
	HEIGHT-ADJUSTABLE UNIT LAMINATE Top & Ledge	24"	72"	30-39" / 36-45"	\$ 14,308	
NV-4700-C-F-HA	HEIGHT-ADJUSTABLE UNIT CUSTOM Top & Ledge				Inquire for Quote	
	4701 Series; MOBILE Unit 4" Casters, 72" RECTANGULAR, Steel Panels, 6" Depth Patron Ledge, 3" Grommet, Wire Management; LAMINATE Top & Ledge	24"	72"	30" / 36"	\$ 9,982	
NV-4701-L-M	CUSTOM Top & Ledge				Inquire for Quote	
	STANDING UNIT, LAMINATE Top & Ledge	24"	72"	39" / 45"	\$ 11,141	
NV-4701-L-M-S	CUSTOM Top & Ledge				Inquire for Quote	
	STANDING UNIT, CUSTOM Top & Ledge	24"	72"	30-39" / 36-45"	\$ 14,618	
NV-4701-L-M-HA	CUSTOM Top & Ledge				Inquire for Quote	
	HEIGHT-ADJUSTABLE UNIT LAMINATE Top & Ledge	24"	72"	30-39" / 36-45"	\$ 14,618	
NV-4701-C-M-HA	HEIGHT-ADJUSTABLE UNIT CUSTOM Top & Ledge				Inquire for Quote	

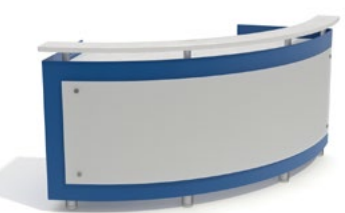
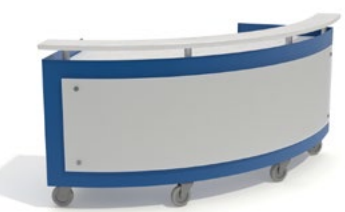
MODEL NUMBER	PRODUCT	WIDTH	LENGTH	HEIGHT TOP / OVERALL	PRICE	DESCRIPTION
	4800 Series; FIXED Unit 72" RECTANGULAR, Wood/Steel Panels, 6" Depth Patron Ledge, 3" Grommet, Wire Management; LAMINATE Top & Ledge	24"	72"	30" / 36"	\$ 10,185	WORK SURFACE & LEDGE: Tops are constructed of 1" thick 3-ply particleboard core. The Tops' surfaces are laminated with a .050" thick high pressure plastic laminate sheet and bottom surface laminated with a backing sheet not less than .020" thick for balanced construction. All edges will be banded with a 1/8" thick acrylic edge.
NV-4800-L-F						METAL ASSEMBLY: Metal components consists of a 16 gauge perforated return panel, and 2 1/2" diameter legs. As a standard the Return panel and Legs will consist of ONE paint color option.
NV-4800-C-F	CUSTOM Top & Ledge				Inquire for Quote	
	STANDING UNIT, LAMINATE Top & Ledge	24"	72"	39" / 45"	\$ 11,344	WOOD PANEL: The main panel's construction consists of a 1" thick 4-ply particleboard core with plain sliced veneer both faces.
NV-4800-L-F-S						
NV-4800-C-F-S	STANDING UNIT, CUSTOM Top & Ledge				Inquire for Quote	
	HEIGHT-ADJUSTABLE UNIT LAMINATE Top & Ledge	24"	72"	30-39" / 36-45"	\$ 14,821	CASTER (Unit 4801 only): The unit comes with a 4" diameter swivel caster with brake.
NV-4800-L-F-HA						DECORATIVE PANEL: The front of the unit has a 1/4" thick frosted acrylic panel with diameter stand-off hardware. For custom decorative acrylic panel, please inquire with Palmieri for pricing.
NV-4800-C-F-HA	HEIGHT-ADJUSTABLE UNIT CUSTOM Top & Ledge				Inquire for Quote	
						NOTES: * Custom Top and Ledge materials may include Solid Surface, Quartz, or Natural Stone. * Standard work surface height is 30". Optional ADA height of 32" is available by request. * Metal Paint color for the Return Panel and Legs must be specified at the time of order. * Grommet and Wire Management are included in price.
	4801 Series; MOBILE Unit 4" Casters, 72" RECTANGULAR, Wood/Steel Panels, 6" Depth Patron Ledge, 3" Grommet, Wire Management; LAMINATE Top & Ledge	24"	72"	30" / 36"	\$ 10,495	
NV-4801-L-M						
NV-4801-C-M	CUSTOM Top & Ledge				Inquire for Quote	
	STANDING UNIT, LAMINATE Top & Ledge	24"	72"	39" / 45"	\$ 11,654	
NV-4801-L-M-S						
NV-4801-C-M-S	STANDING UNIT, CUSTOM Top & Ledge				Inquire for Quote	
	HEIGHT-ADJUSTABLE UNIT LAMINATE Top & Ledge	24"	72"	30-39" / 36-45"	\$ 15,131	
NV-4801-L-M-HA						
NV-4801-C-M-HA	HEIGHT-ADJUSTABLE UNIT CUSTOM Top & Ledge				Inquire for Quote	

	MODEL NUMBER	PRODUCT	WIDTH	LENGTH	HEIGHT TOP / OVERALL	PRICE	DESCRIPTION
		5100 Series; FIXED Unit Steel Panel, 6" Depth Patron Ledge,					
	NV-5100-L-F	LAMINATE Top & Ledge	35 ³ / ₈ "	83 ¹ / ₂ "	30" / 36"	\$ 14,131	<p>WORK SURFACE & LEDGE: Tops are constructed of 1" thick 3-ply particleboard core. The Tops' surfaces are laminated with a .050" thick high pressure plastic laminate sheet and bottom surface laminated with a backing sheet not less than .020" thick for balanced construction. All edges will be banded with a 1/8" thick acrylic edge.</p> <p>METAL ASSEMBLY: Metal components consists of a 16 gauge non-perforated main panel and 2 1/2" diameter legs. As a standard the Main panel and Legs will consist of ONE paint color option. Dual color combinations are available by request only. The application for Dual color finishes will be the following: Main panel with color #1, Legs with color #2.</p> <p>CASTER (Unit 5101 only): The unit comes with a 4" diameter swivel caster with brake.</p> <p>DECORATIVE PANEL: The front of the unit has a 1/4" thick frosted acrylic panel with diameter stand-off hardware. For custom decorative acrylic panel, please inquire with Palmieri for pricing.</p> <p>NOTES: * Custom Top and Ledge materials may include Solid Surface, Quartz, or Natural Stone. * Standard work surface height is 30". Optional ADA height of 32" is available by request. * Metal Paint color(s) for the Panels and Legs must be specified at the time of order.</p>
	NV-5100-C-F	CUSTOM Top & Ledge				Inquire for Quote	
	NV-5100-L-F-S	STANDING UNIT, LAMINATE Top & Ledge	35 ³ / ₈ "	83 ¹ / ₂ "	39" / 45"	\$ 15,662	
NV-5100-C-F-S	STANDING UNIT, CUSTOM Top & Ledge				Inquire for Quote		
		5101 Series; MOBILE Unit 4" Casters Steel Panel, 6" Depth Patron Ledge,					
	NV-5101-L-M	LAMINATE Top & Ledge	35 ³ / ₈ "	83 ¹ / ₂ "	30" / 36"	\$ 14,475	
	NV-5101-C-M	CUSTOM Top & Ledge				Inquire for Quote	
	NV-5101-L-M-S	STANDING UNIT, LAMINATE Top & Ledge	35 ³ / ₈ "	83 ¹ / ₂ "	39" / 45"	\$ 16,006	
	NV-5101-C-M-S	STANDING UNIT, CUSTOM Top & Ledge				Inquire for Quote	

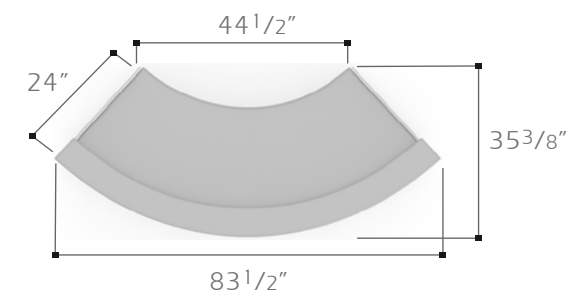







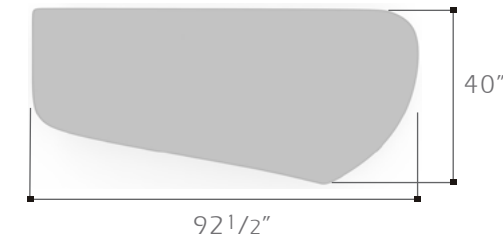

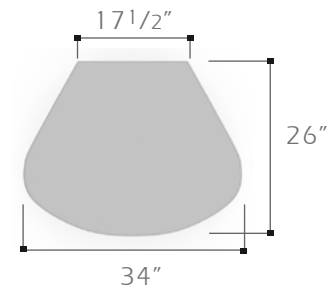

*Monitor Arm and RFID Equipment shown are NOT Included

MODEL NUMBER	PRODUCT	WIDTH	LENGTH	HEIGHT TOP / OVERALL	PRICE	DESCRIPTION
	6100 Series; FIXED Unit Steel Panels, 2 Lockable Steel Doors, Fixed Interior Shelf, Wire Management,					
NV-6100-L-F	LAMINATE Top	40"	92 1/2"	36"	\$ 23,681	<p>WORK SURFACE: Tops are constructed of 1" thick 3-ply particleboard core. The Tops' surfaces are laminated with a .050" thick high pressure plastic laminate sheet and bottom surface laminated with a backing sheet not less than .020" thick for balanced construction. All edges will be banded with a 1/8" thick acrylic edge.</p> <p>METAL ASSEMBLY: Metal components consists of a 16 gauge non-perforated bowed service end, a 16 gauge perforated locking cupboard unit, and 2 1/2" diameter legs. As a standard the Bowed Service End, Cupboard unit, and Legs will consist of ONE paint color option. Dual color combinations are available by request only. The application for Dual color finishes will be the following: Bowed Service End with color #1, Cupboard and Legs with color #2.</p> <p>DECORATIVE PANEL: The front of the unit has a 1/4" thick frosted acrylic panel with diameter stand-off hardware. For custom decorative acrylic panel, please inquire with Palmieri for pricing.</p> <p>NOTES: * Custom Top materials may include Solid Surface, Quartz, or Natural Stone. * Monitor, Monitor Arm, and RFID Equipment are NOT included. * Grommet, Wire Management, and RFID cut out location are included in the price. * Metal Paint color(s) for the Panels and Legs must be specified at the time of order.</p>
NV-6100-C-F	CUSTOM Top				Inquire for Quote	
	7101 Series; MOBILE Unit 4" Casters Lockable Door Steel Panels,					
NV-7101-L-M	LAMINATE Top	20"	20"	30"	\$ 5,750	<p>WORK SURFACE: Same as work surface for unit 6100 shown above.</p> <p>METAL ASSEMBLY: Metal components consists of a 16 gauge perforated locking cupboard unit. As a standard the unit will consist of ONE paint color option.</p> <p>CASTER: The unit comes with a 4" diameter swivel caster with brake.</p> <p>NOTES: * Custom Top materials may include Solid Surface, Quartz, or Natural Stone. * Metal Paint color for the unit must be specified at the time of order.</p>
NV-7101-C-M	CUSTOM Top				Inquire for Quote	

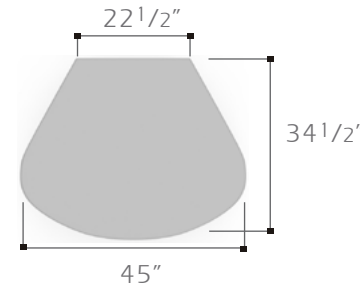

	MODEL NUMBER	PRODUCT	WIDTH	LENGTH	HEIGHT TOP / OVERALL	PRICE	DESCRIPTION
 <p>*Monitor with Arm shown NOT Included</p>		8100 Series; A.D.A. FIXED Unit, Steel Panels, 3" Grommet;					<p>WORK SURFACE: Tops are constructed of 1" thick 3-ply particleboard core. The Tops' surfaces are laminated with a .050" thick high pressure plastic laminate sheet and bottom surface laminated with a backing sheet not less than .020" thick for balanced construction. All edges will be banded with a 1/8" thick acrylic edge.</p>
	NV-8100-L-F	LAMINATE Top	26"	34"	32"	\$ 14,013	
	NV-8100-C-F	CUSTOM Top				Inquire for Quote	<p>METAL ASSEMBLY: Metal components consists of a 16 gauge non-perforated Bowed or Concave (ADA option) Service End, and 2 1/2" diameter legs. As a standard the Bowed or Concave Service End, and Legs will consist of ONE paint color option. Dual color combinations are available by request only. The application for Dual color finishes will be the following: Bowed or Concave Service End with color #1, and legs with color #2.</p>
 <p>*Monitor with Arm shown NOT Included</p>		8101 Series; A.D.A. MOBILE Unit, 4" Casters, Steel Panels, 3" Grommet;					<p>CASTER (Units 8101 & 8201 only): The unit comes with a 4" diameter swivel caster with brake.</p>
	NV-8101-L-M	LAMINATE Top	26"	34"	32"	\$ 14,250	
	NV-8101-C-M	CUSTOM Top				Inquire for Quote	<p>DECORATIVE PANEL: The front of the unit has a 1/4" thick frosted acrylic panel with diameter stand-off hardware. For custom decorative acrylic panel, please inquire with Palmieri for pricing.</p> <p>NOTES: * Custom Top and Ledge materials may include Solid Surface, Quartz, or Natural Stone. * Monitor, and Monitor Arm are NOT included. * Grommet is included in the price. * Metal Paint color(s) for the Panels and Legs must be specified at the time of order.</p>
 <p>*Monitor with Arm shown NOT Included</p>		8200 Series; FIXED Unit, Steel Panels, 3" Grommet;					
	NV-8200-L-F	LAMINATE Top	26"	34"	36"	\$ 15,513	
	NV-8200-C-F	CUSTOM Top				Inquire for Quote	
 <p>*Monitor with Arm shown NOT Included</p>		8201 Series; MOBILE Unit, 4" Casters, Steel Panels, 3" Grommet;					
	NV-8201-L-M	LAMINATE Top	26"	34"	36"	\$ 15,750	
	NV-8201-C-M	CUSTOM Top				Inquire for Quote	

	MODEL NUMBER	PRODUCT	WIDTH	LENGTH	HEIGHT TOP / OVERALL	PRICE	DESCRIPTION
 <p>*Monitor Arm and RFID Equipment shown are NOT Included</p>	NV-9100-L-F	9100 Series; A.D.A. FIXED Unit, Steel Panels; LAMINATE Top	34 1/2"	45"	32"	\$ 14,144	<p>WORK SURFACE: Tops are constructed of 1" thick 3-ply particleboard core. The Tops' surfaces are laminated with a .050" thick high pressure plastic laminate sheet and bottom surface laminated with a backing sheet not less than .020" thick for balanced construction. All edges will be banded with a 1/8" thick acrylic edge.</p> <p>METAL ASSEMBLY: Metal components consists of a 16 gauge non-perforated Bowed or Concave (ADA option) Service End, and 2 1/2" diameter legs. As a standard the Bowed or Concave Service End, and Legs will consist of ONE paint color option. Dual color combinations are available by request only. The application for Dual color finishes will be the following: Bowed or Concave Service End with color #1, and legs with color #2.</p> <p>CASTER (Units 8101 & 8201 only): The unit comes with a 4" diameter swivel caster with brake.</p> <p>DECORATIVE PANEL: The front of the unit has a 1/4" thick frosted acrylic panel with diameter stand-off hardware. For custom decorative acrylic panel, please inquire with Palmieri for pricing.</p> <p>NOTES: * Custom Top and Ledge materials may include Solid Surface, Quartz, or Natural Stone. * Monitor, Monitor Arm, and RFID Equipment are NOT included. * Grommet, Wire Management, and RFID cut out location are included in the price. * Metal Paint color(s) for the Panels and Legs must be specified at the time of order.</p>
	NV-9100-C-F	CUSTOM Top				Inquire for Quote	
 <p>*Monitor Arm and RFID Equipment shown are NOT Included</p>	NV-9101-L-M	9101 Series; A.D.A. MOBILE Unit, 4" Casters, Steel Panels; LAMINATE Top	34 1/2"	45"	32"	\$ 14,369	<p>DECORATIVE PANEL: The front of the unit has a 1/4" thick frosted acrylic panel with diameter stand-off hardware. For custom decorative acrylic panel, please inquire with Palmieri for pricing.</p> <p>NOTES: * Custom Top and Ledge materials may include Solid Surface, Quartz, or Natural Stone. * Monitor, Monitor Arm, and RFID Equipment are NOT included. * Grommet, Wire Management, and RFID cut out location are included in the price. * Metal Paint color(s) for the Panels and Legs must be specified at the time of order.</p>
	NV-9101-C-M	CUSTOM Top				Inquire for Quote	
 <p>*Monitor Arm and RFID Equipment shown are NOT Included</p>	NV-9200-L-F	9200 Series; FIXED Unit, Steel Panels; LAMINATE Top	34 1/2"	45"	36"	\$ 15,638	
	NV-9200-C-F	CUSTOM Top				Inquire for Quote	
 <p>*Monitor Arm and RFID Equipment shown are NOT Included</p>	NV-9201-L-M	9201 Series; MOBILE Unit, 4" Casters, Steel Panels; LAMINATE Top	34 1/2"	45"	36"	\$ 15,869	
	NV-9201-C-M	CUSTOM Top				Inquire for Quote	

Palmieri Furniture Limited ("Palmieri") warrants that its products and collections are free from defects in materials and workmanship for the life of the product, except as set forth below. Palmieri Limited Lifetime Warranty is valid from the date of delivery.

Exceptions to the Limited Lifetime Warranty: Seating: two (2) years

Goods sold hereunder are covered by a Limited Lifetime Warranty, free against defects in material and workmanship provided the goods and services are subjected to normal use and service. The applicable warranty period commences from shipping date to Purchaser of any item of the goods, whichever occurs first, or any other warranty period otherwise stipulated in writing by Palmieri under this sale. For components not supplied by Palmieri, the original manufacturer's warranty shall apply to the extent assignable by Palmieri. The obligation under this warranty is limited to the repair or replacement, at Palmieri's option, of defective parts F.O.B. point of shipment provided that prompt notice of any defect is given by Purchaser to Palmieri in writing within the applicable warranty period and that upon the Purchaser's return of the defective parts to Palmieri or, if designated by Palmieri, to the location where the works are made, properly packed and with transportation charges prepaid by Purchaser, an inspection thereof shall reveal to Palmieri's satisfaction that Purchaser's claim is valid under the terms of this warranty. Purchaser shall assume all responsibility and expense for dismantling, removal, re-installation and freight in connection with the foregoing. The same obligations and conditions extend to replacement parts furnished by Palmieri hereunder.

Palmieri does not assume liability for installation, labour or consequential damages. Palmieri makes no warranty other than the one set forth herein. All other warranties, legal, expressed or implied, including but not limited to any expressed or implied warranty of merchantability, of fitness for the intended use thereof or against infringement are hereby expressly excluded. The applicable warranty ceases to be effective if the goods are altered or repaired other than by persons authorized or approved by Palmieri to perform such work. Repairs or replacement deliveries do not interrupt or prolong the term of the warranty. The warranty ceases to be effective if Purchaser fails to handle and use the goods sold hereunder in a safe and reasonable manner and in accordance with any written instructions from the manufacturers.

Warranty Does Not Apply To Product Failure Or Loss Resulting From:

Abuse, misuse or accident, alteration or modification of product by customer or third party, normal wear and tear, improper installation, handling or incorrect use. The substitution of part components or hardware not approved or authorized by Palmieri, acts of God, unauthorized repairs, improper storage, and environmental conditions such as irregular temperature control either inside or outside the environment.

Warranty Provides Exclusive Remedies:

If a product fails under ordinary use as a result of a defect in material or workmanship, Palmieri will: (A) repair, or (B) replace the furniture. The replacement or repair of the Furniture or Seating will be at the discretion of Palmieri. If the defect or workmanship cannot be remedied on site, repairs can be made at the factory. (C) If the product repair or replacement is not commercially practicable or cannot be remade in a timely manner Palmieri will refund the purchase price of the affected product. A product "**Defect**" means: an inadequacy in the materials or workmanship of the product that (A) existed at the time when you received the product from Palmieri or Palmieri authorized Reseller and (B) causes a failure of the product to perform under ordinary use in accordance with the materials and documentation accompanying the product. "**Ordinary Use**" means: use of the product (A) in accordance with all applicable local, state or federal laws, codes and regulations and (B) in accordance with manufacturer recommendations and or instructions in the materials and documentation accompanying the product or through shop drawings. A "**Palmieri Authorized Reseller**" means: any dealer that is legally permitted to conduct business in the jurisdiction where the product is sold and is duly authorized by Palmieri to sell the product.

Warranty work must be approved by authorized personnel of Palmieri Furniture Limited in Richmond Hill, Ontario, Canada.

A copy of the original purchase order must accompany all claims.

Warranty Does Not Cover:

Matching of colours, stains, textures, grains and any other variations in materials. Select and Custom Surfaces and materials are only warranted for their application on the specified product and are not covered by our warranty, except as warranted by the original supplier, for quality, colorfastness, shade variations or abrasion and textiles purchased for Palmieri product.

This limited warranty is the sole remedy for product defect and no other express or implied warranty is provided. Warranty is not transferable and valid only for the original purchaser acquiring a product from Palmieri or a Palmieri authorized reseller for the purchaser's own use and not for resale, remarketing or distribution. Limited Lifetime Warranty (25 years)

GENERAL

The following Terms and Conditions of Quote and Sale shall apply to any sale of goods and services by Palmieri Furniture Limited (hereinafter called "Palmieri"). Purchaser shall be deemed to have full knowledge of the terms and conditions herein and such terms and conditions shall be binding if either the goods and services referred to herein are delivered to and accepted by Purchaser, or if Purchaser does not within five (5) days from the date hereof deliver to Palmieri written objection to said terms and conditions or any part thereof.

In the event of any conflict or inconsistency between the terms and conditions of sale herein and the terms and conditions contained in Purchaser's order or in any other form issued by Purchaser, whether or not any such form has been acknowledged or accepted by Palmieri, Palmieri's terms and conditions herein shall prevail. No waiver, alteration or modification of these terms and conditions shall be binding upon Palmieri unless made in writing and signed by a duly authorized representative of Palmieri.

1. QUOTATIONS / PRODUCT QUOTED

Unless otherwise stated, **Palmieri's quotations shall be null and void unless accepted by Purchaser within thirty (30) days from the date of quotation.** Quotes may be subject to change before order placement, due to increased material costs and or other factors that could impact the final cost of production and our final understanding of the product required. If the items quoted do not reflect the intended product requirements of the customer, Palmieri will not be held responsible for increased costs for those product changes. We reserve the right to edit or re-quote any portion of a previously submitted quotation subject to our final understanding of the product required by the client.

2. PALMIERI DRAWINGS

Palmieri provides drawings for Custom & Standard product we produce to our clients upon request. We consider these drawings to be Private and Confidential and are provided for the sole purpose and use of our clients to understand the product we are providing. The use of these confidential materials is limited to the transaction between the parties and at no point are these confidential materials to be sent to any of our competitors or parties quoting for the same purpose.

A minimum \$85.00 NET Engineering Administrative Fee will apply for Custom Product Drawings

(Note: The first set of Custom product drawings will be free of charge)

A minimum \$120.00 NET Engineering Administrative Fee will apply for all Standard Product Drawings

3. TERMS OF PAYMENT

For authorized customers; Orders at a \$75,000.00 threshold will require a mandatory 25% deposit. Orders over and above \$100,000.00 requires a mandatory (25%) deposit at time of order, a mandatory (25%) deposit prior to product shipment and the balance to be paid within thirty (30) days of date of shipment. Payment not be made to Palmieri when due, Palmieri reserves the right to charge Purchaser with interest on such overdue payments. Interest of 2% per month (24% per annum) is charged on all overdue accounts, unless otherwise specified. The charging of such interest shall not be construed as obligating Palmieri to grant any extension of time in the terms of payment. All goods remain the property of Palmieri, until balance is paid in full to Palmieri.

4. TITLE

Title to the goods or any part thereof shall not pass from Palmieri to Purchaser until all payments due hereunder have been duly made, except as otherwise expressly stipulated herein. The goods shall be and remain personal or moveable property, notwithstanding their mode of attachment to realty or other property. If default is made in any of the payments herein, Purchaser agrees that Palmieri may retain all payments which have been made on account of the purchase price as liquidated damages, and Palmieri shall be free to enter the premises where the goods may be located and remove them as Palmieri's property, without prejudice to Palmieri's right to recover any further expenses or damages Palmieri may suffer by reason of such nonpayment.

5. TAXES

Prices do not include Goods & Services Tax, Provincial or Municipal sales, use, value-added or similar tax. All applicable taxes are extra. Our Harmonized Sales Tax (HST) registration number is R104055066.

6. THE AGREEMENT

An acceptance and official confirmation of Purchasers' order by signing Palmieri's Order Confirmation the Purchaser therefore is accepting terms and conditions as expressed herein Palmieri's Terms and Conditions of Quote and Sale by Palmieri and shall constitute the complete agreement, subject to the terms and conditions of sale herein set forth, and shall supersede all previous quotations, orders or agreements.

7. LEAD TIME / DELIVERY / DELAYS

Lead time is determined only when final material/finish selection and drawing approvals are received by Palmieri from the client. The accuracy of Palmieri's lead times, is created to the best of our ability with the information provided to us. Confirmed lead time is conveyed to the client by means of Order Confirmation. They do not preclude the client from checking the accuracy of your requirement and our Order Confirmation. Any noted discrepancies are to be reported immediately to Palmieri Customer Service Department for correction and re-issue of revised Order Confirmation. By signing and dating the Order Confirmation the client accepts the terms and conditions of quote and sale.

Lead time on our Order Confirmation do not account for delays that could potentially occur for special materials specified by the client that are outside of our standard finishes and materials program that are out of our control

and will affect the lead time on the order. Palmieri will notify the client immediately when these delays occur and adjust the lead time accordingly.

Delivery schedules are approximate and are based on prevailing market conditions applicable respectively at the time of Palmieri's quotation and Palmieri's acceptance of clients' order, if certain portions of an order are completed by the quoted lead time while other portions have experienced delays outside of our control. The client may choose to part ship the order at their discretion and expense. Otherwise the entire order will ship with the delayed portion at a later date. Palmieri may extend delivery schedules or may, at its option, cancel Purchaser's order in full or in part without liability other than to return any deposit or prepayment which is unearned by reason of the cancellation.

8. CHANGES AND CANCELLATION

Orders accepted by Palmieri are not subject to changes or cancellation by Purchaser without the written consent of Palmieri. In such cases where Palmieri authorizes changes or cancellation, Palmieri reserves the right to charge the Purchaser with reasonable costs based upon expenses already incurred and commitments made by Palmieri, including, without limitation, any labour done, material purchased and also including Supplier's usual overhead and reasonable profit and cancellation charges from Palmieri's suppliers. Palmieri will communicate to the Purchaser additional costs incurred by way of Revised Order Confirmation. Revised Order Confirmation will include applicable costs incurred and modification to lead times (if applicable). The Purchaser must provide Palmieri written confirmation of additional costs, before any changes can be processed on the order.

A minimum charge of \$100.00 NET Change Order Request fee will apply

A minimum charge of \$150.00 NET Cancel Order Request fee will apply.

9. SHIPPING LOCATION / SHIPPING QUOTES / COST OF TRANSPORTATION

Unless otherwise stated, all prices are F.O.B. our factory in Richmond Hill, Ontario, Canada.

Customary methods of transportation shall be selected by Palmieri and such transportation will be at Purchaser's expense. Shipping quotations are made at time of furniture quotation and are outside the control of Palmieri. **Shipping quotes are valid for ten (10) business days from the time of quote.** We do our best to maintain shipping costs as quoted, however all shipping weights and cubic feet shown are approximate only, various construction materials and packaging methods may add to the weights given. All quoted prices, unless otherwise stated on the quotation, are based on the current exchange rates, tariffs, fuel surcharges and costs of manufacture and are subject to change by Palmieri with or without notice until Purchaser's acceptance. Palmieri does not assume responsibility or liability for shipping costs, product during transit, or variances from the shipping weights or cubic feet shown in our specification guides. Special methods of transportation will be used upon Purchaser's request and at Purchaser's additional expense, provided reasonable notice of Purchaser's transportation requirements are given by Purchaser to Palmieri prior to shipment. Palmieri will notify the client prior to shipping product if shipping costs as quoted change, at which point the client must approve the adjusted shipping costs.

10. RECEIVING PRODUCT / REPORTING DAMAGE / STORAGE OF PRODUCT

Upon receipt of Palmieri product, the receiver of the goods must immediately inspect the product to ensure it is free of shipping damage. If the product is deemed in good order, the receiver of the product must ensure

to sign off on the accompanying carriers Bill of lading in good condition. Except for obligations stated under "Warranty" herein, Palmieri's responsibility for the product ceases once the product has been received and signed off in good order and is the full responsibility of the receiver and subsequently the owner.

In the event shipping damage is discovered during receipt of shipment, it is the responsibility of the receiver to ensure all noted damage is recorded on the carrier's Bill of Lading prior to sign off. All noted shipping damage claims must be reported to Palmieri within **24 hours** of receipt of the product onsite, failure to do so will result in the claim being deemed null and void. All shipping damage claims are to be reported directly to Palmieri's Shipping Manager. Please call our toll free number at **1-800-413-4440 ext. 33** or submit the claim by Fax directly to **1-905-731-9878**. Palmieri will not accept any shipping damage claims submitted **after 24 hours** and it shall be conclusively presumed that the goods were delivered in good condition.

Storage of product, Palmieri will not be held responsible for any potential damages or shortages for product shipped and received by Purchaser and is subsequently placed into storage and not inspected within 24 hours of receipt.

11. INSTALLATION / SHORTAGES / BACK CHARGES

Unless otherwise expressly stipulated, the goods shall be installed by and at the risk and expense of Purchaser.

In the event that Palmieri is requested to supervise such installation, Palmieri's responsibility shall be limited to exercising that degree of skill customary in the trade in supervising installations of the same type. Purchaser shall remain responsible for all other aspects of the work including compliance with the local regulations. It is the responsibility of the Purchaser to ensure hardware and parts are received in good order. Packing slip and hardware list to be provided by Palmieri with every order at time of shipping. Purchaser has the responsibility to notify Palmieri immediately without delay of issues that arise; subsequently Palmieri will take action to provide prompt resolution.

Shortages must be reported to Palmieri within **24 hours** of receipt of the goods and failure to do so may be at the expense of the Purchaser.

If deemed missing hardware and parts short shipped from the factory, Palmieri will arrange to ship freight prepaid to destination. Palmieri will only be responsible for replacement costs of missing hardware and parts, any labour costs incurred will be the responsibility of the Purchaser and will not be approved by Palmieri.

Back Charges will only be approved if we deemed a defect in the material or workmanship is found during the installation period resulting in a return trip to the job-site to complete installation. It shall remain the sole discretion of Palmieri to approve (A) repair or (B) replace the furniture and any labour costs incurred by the Purchaser.

12. FORCE MAJEURE

Palmieri shall not be responsible or liable for any loss or damage incurred by Purchaser herein resulting from causes beyond the reasonable control of Palmieri including, but without limitation, abuse, misuse or accident, alteration or modification of product by customer or third party, normal wear and tear, improper installation, handling or incorrect use, unauthorized repairs, the substitution of part components or hardware not approved or authorized by Palmieri, improper storage, and environmental conditions such as irregular temperature control

either inside or outside the environment, acts of God, fire, flood, delays in transportation, or the failure of Palmieri's suppliers to meet their delivery promises. The acceptance of delivery of the goods by Purchaser shall constitute a waiver of all claims for loss or damage due to any delay whatsoever.

13. RETURNED GOODS

No goods may be returned to Palmieri for a credit or exchanged without Palmieri's prior written consent.

Palmieri reserves the right to accept all returns and subject to a handling/restocking charge or to decline all returns. Even after Palmieri has authorized the return of goods for credit, Palmieri reserves the right to adjust the amount of any credit given to Purchaser on return of the goods based on the conditions of the goods on arrival in Palmieri's warehouse. Credit for returned goods will be issued to Purchaser only where such goods are returned by Purchaser and not by any subsequent owner of the goods. Goods will be considered for return only if they are in their original condition and packaging. Palmieri Goods Return Authorization Form to be issued and **must** accompany all shipments returning back to the factory. **Return freight must be prepaid by Purchaser. A minimum 20% re-stocking fee will apply.**

1230 Reid Street
Richmond Hill
Ontario Canada
L4B 1C4

T 905 731 9300
F 905 731 9878
TF 800 413 4440
info@palmierifurniture.com
www.PalmieriFurniture.com











SPECIFICATION GUIDE & PRICE LIST



















2017

PALMIER

P2[®]

CATEGORY: LIBRARY FURNITURE
CONTRACT: BID #ESCNJ 17/18-16

Introduction	1	Fluid	30-33
Table of Contents	2-7	 Tables	30-31
Product Materials & Finishes	8-11	 Computer Stations	32-33
Econoline	12-29	Lagoon	34-37
 Boxy Frame – Round & Square Tables	12-13	 Table Pods & Center Pods	34-35
Boxy Frame – Rectangle Tables	14-15	 Configurations	36-37
Boxy Frame – Trapezoidal Tables	16-17		
 Round & Square Tables	18-19	Leaf	38-41
Rectangle Tables	20-21	 Tables	38-39
Trapezoidal & Race Track Tables	22-23	 Configurations	40-41
 Tubular T-Leg – Round & Square Tables	24-25	Pond	42-69
Tubular T-Leg – Rectangle & Race Track Tables	26-27	 Tables	42-69
 Workstations	28-29		

Solo		70-95	Team		96-135
	Round Tables	70-73		Half End Conference	96-97
	Half Round Tables	74-75		End Cap Conference	98-99
	Quarter Round Tables	76-77		Curve Conference	100-107
	Square Tables	78-79		Round End Conference & Square Computer Station T-Base	108-109
	Rectangle Tables	80-87		Rectangle Computer Station T-Base	110-115
	Trapezoidal & Barrel Shape Tables	88-89		Puzzle Computer Station T-Base	116-117
	Puzzle Shape Tables	90-91		Square Computer Station Leg Base	118-119
	Triangle Tables	92-93		Rectangle Computer Station Leg Base	120-127
	Corner Workstations	94-95		Puzzle Computer Station Leg Base	128-129
				Mobile Pedestal Desks	130-131

<hr/>		Accessories	154-157
Team Continued		Electrical	158-159
	Mobile Storage	Warranty	160
		Terms & Conditions	161
Wave			
	Wave II Carrels & Workstations Side by Side		
	Wave II Carrels & Workstations Side by Side, Back to Back		
	Wave III Carrels & Workstations Side by Side		
	Wave III Carrels & Workstations Side by Side, Back to Back		
	Wave Accessories		

METAL PAINT:

Thermal Paint Colours



EDGE BAND COLOURS:

PVC edge band colour options



HARDWOODS: All hardwood materials used in the manufacturing of Palmieri products shall be Northern grown hardwoods. Hardwoods will be air and kiln dried to a moisture content of 5-7%. All hardwoods shall be of grade "A" material, free of material stains, imperfections, conformity of grain, texture and color. Hardwood species shall be Northern grown Red Oak, Clear White Northern Maple and Birch. American Cherry and Honduras Mahogany and Walnut are available. Please inquire for pricing.

VENEER: Exposed face veneers shall be not less than 1/28" thick plain sliced veneers. Veneers are to be selected for conformity of grain direction and color. Veneers are to be stitched tightly in a book match, slip match or plain sliced configuration. Unexposed veneers are to be of hardwood but not selected for color, or grain quality. Veneers are not to be lap joined or reveal any tape or glue lines.

PARTICLE BOARD CORE: The particleboard shall be formed of wood chips, bonded with a water resistance adhesive. The particleboard material is to be of a high density 45 lbs/cu. ft. having a minimum average modulus of rupture of 2400 psi and a minimum average modulus of elasticity of 4,000,000 psi.

VENEER CORE: Veneer core is to be constructed with odd numbers of plies. Each ply is to be laminated in pairs and cross banded in opposite directions with grain direction at a 90 degree angle to the grain of the center core. All plies are to be free from knots, wrinkles, laps or other natural or manufacturing defects.

LUMBER CORE: Lumber core is to be of the highest quality grade. Grade "A" select stock. Lumber core shall be constructed of solid random width strips not less than 2" wide nor more than 3 1/2" wide by 1" thick. Wood strips will be free from knots or other defects. All strips will be tightly joined using water resistance adhesives.





HIGH PRESSURE LAMINATE: Work surface laminate shall be .050" thick and used with balancing backer sheet of no less than .028" thick. Laminate shall conform to standards set by the American Standards Institute/National Electrical Manufacturers Association (ANSI/NEMA) for thickness, performance and appearance. Printed colours, abstract patterns and wood grains are reproduced from representative segments of large sheets and may differ slightly from the actual product.



FINISHING PROCEDURES: All materials shall be inspected and treated with a final sanding and polishing operation before any staining and final finishing can be performed. All machine and mill marks are to be removed. Once the polishing and sanding has been performed, the furniture will then undergo the following stain and finishing procedures:

- Step 1 A base stain will be uniformly applied, wiped and then allowed to dry under factory controlled conditions.
- Step 2 A uniform coat of sealer will be applied and allowed to dry.
- Step 3 Sealer will be lightly sanded using 240 grit silicon paper.
- Step 4 A catalytic lacquer of 34-45 degree sheen is evenly applied and allowed to dry under factory controlled conditions.



METAL FINISHING PROCEDURES: All metal components are thoroughly cleaned and coated electrostatically with an epoxy powder coat paint finish. The metal components are then oven baked and cured for a lasting finish.





EDGE BANDS: All edge bands are manufactured in PVC, semi-rigid (Flex) and ABS. Standard edging size are normally 1.25" wide x 3 mm thick. These are made of the highest grade polymers and its materials are extensively tested prior to production using special test procedures and industry specification and quality standards.





MODEL NUMBER	PRODUCT	WIDTH	DEPTH	HEIGHT	WEIGHT	VOLUME	LIST PRICE	DESCRIPTION	
	ROUND Tables;							Each table is constructed of a 1" thick top with a plastic laminate top surface.	
	EO-R36-AC-S EO-R36-BN-S	36" Diameter: Acrylic Edge; Boxy Frame Bullnose Edge; Boxy Frame	36" Diameter	29"	___ Lbs.	___ Cu Ft	\$ 1,288 \$ 1,413	There are two edge profiles available:	
	EO-R42-AC-S EO-R42-BN-S	42" Diameter: Acrylic Edge; Boxy Frame Bullnose Edge; Boxy Frame	42" Diameter	29"	___ Lbs.	___ Cu Ft	\$ 1,363 \$ 1,594	 	
	EO-R48-AC-S EO-R48-BN-S	48" Diameter: Acrylic Edge; Boxy Frame Bullnose Edge; Boxy Frame	48" Diameter	29"	___ Lbs.	___ Cu Ft	\$ 1,450 \$ 1,713	Model "AC" Acrylic Edge Model "BN" 3/4" Bullnose Edge	
								The metal frame is 3" High C-Channel 18 gauge steel with corner plates for leg attachment.	
		SQUARE Tables;							
EO-3636-AC-S EO-3636-BN-S		36" Width: Acrylic Edge; Boxy Frame Bullnose Edge; Boxy Frame	36"	36"	29"	___ Lbs.	___ Cu Ft	\$ 1,313 \$ 1,556	
EO-4242-AC-S EO-4242-BN-S		42" Width: Acrylic Edge; Boxy Frame Bullnose Edge; Boxy Frame	42"	42"	29"	___ Lbs.	___ Cu Ft	\$ 1,394 \$ 1,681	



MODEL NUMBER	PRODUCT	WIDTH	DEPTH	HEIGHT	WEIGHT	VOLUME	LIST PRICE	DESCRIPTION	
	RECTANGLE Tables;							Each table is constructed of a 1" thick top with a plastic laminate top surface.	
		24" Depth:						There are two edge profiles available:	
	EO-3624-AC-S EO-3624-BN-S	Acrylic Edge; Boxy Frame Bullnose Edge; Boxy Frame	36"	24"	29"	___ Lbs.	___ Cu Ft	\$ 1,200 \$ 1,400	
	EO-4824-AC-S EO-4824-BN-S	Acrylic Edge; Boxy Frame Bullnose Edge; Boxy Frame	48"	24"	29"	___ Lbs.	___ Cu Ft	\$ 1,263 \$ 1,500	
	EO-6024-AC-S EO-6024-BN-S	Acrylic Edge; Boxy Frame Bullnose Edge; Boxy Frame	60"	24"	29"	___ Lbs.	___ Cu Ft	\$ 1,325 \$ 1,606	Model "AC" Acrylic Edge
	EO-7224-AC-S EO-7224-BN-S	Acrylic Edge; Boxy Frame Bullnose Edge; Boxy Frame	72"	24"	29"	___ Lbs.	___ Cu Ft	\$ 1,381 \$ 1,706	Model "BN" 3/4" Bullnose Edge
		30" Depth:							The metal frame is 3" High C-Channel 18 gauge steel with corner plates for leg attachment.
	EO-4830-AC-S EO-4830-BN-S	Acrylic Edge; Boxy Frame Bullnose Edge; Boxy Frame	48"	30"	29"	___ Lbs.	___ Cu Ft	\$ 1,313 \$ 1,575	
	EO-6030-AC-S EO-6030-BN-S	Acrylic Edge; Boxy Frame Bullnose Edge; Boxy Frame	60"	30"	29"	___ Lbs.	___ Cu Ft	\$ 1,381 \$ 1,688	
	EO-7230-AC-S EO-7230-BN-S	Acrylic Edge; Boxy Frame Bullnose Edge; Boxy Frame	72"	30"	29"	___ Lbs.	___ Cu Ft	\$ 1,450 \$ 1,800	
	36" Depth:								
EO-6036-AC-S EO-6036-BN-S	Acrylic Edge; Boxy Frame Bullnose Edge; Boxy Frame	60"	36"	29"	___ Lbs.	___ Cu Ft	\$ 1,431 \$ 1,756		
EO-7236-AC-S EO-7236-BN-S	Acrylic Edge; Boxy Frame Bullnose Edge; Boxy Frame	72"	36"	29"	___ Lbs.	___ Cu Ft	\$ 1,506 \$ 1,875		
	42" Depth:								
EO-7242-AC-S EO-7242-BN-S	Acrylic Edge; Boxy Frame Bullnose Edge; Boxy Frame	72"	42"	29"	___ Lbs.	___ Cu Ft	\$ 1,575 \$ 1,969		
EO-8442-AC-S EO-8442-BN-S	Acrylic Edge; Boxy Frame Bullnose Edge; Boxy Frame	84"	42"	29"	___ Lbs.	___ Cu Ft	\$ 1,656 \$ 2,094		
EO-9642-AC-S EO-9642-BN-S	Acrylic Edge; Boxy Frame Bullnose Edge; Boxy Frame	96"	42"	29"	___ Lbs.	___ Cu Ft	\$ 1,744 \$ 2,225		





Model "S"
Boxy Table Frame





MODEL NUMBER	PRODUCT	WIDTH	DEPTH	HEIGHT	WEIGHT	VOLUME	LIST PRICE	DESCRIPTION
 EO-TZ-4824-AC-S EO-TZ-4824-BN-S	TRAPEZOIDAL Tables; 48" Width: Acrylic Edge; Boxy Frame Bullnose Edge; Boxy Frame	48"	24"	29"	___ Lbs.	___ Cu Ft	\$ 1,288 \$ 1,488	Each table is constructed of a 1" thick top with a plastic laminate top surface. There are two edge profiles available: 
	60" Width: Acrylic Edge; Boxy Frame Bullnose Edge; Boxy Frame	60"	30"	29"	___ Lbs.	___ Cu Ft	\$ 1,406 \$ 1,663	Model "AC" Acrylic Edge Model "BN" 3/4" Bullnose Edge The metal frame is 3" High C-Channel 18 gauge steel with corner plates for leg attachment. 
								Model "S" Boxy Table Frame





MODEL NUMBER	PRODUCT	WIDTH	DEPTH	HEIGHT	WEIGHT	VOLUME	LIST PRICE	DESCRIPTION	
	ROUND Tables;							Each table is constructed of a 1" thick top with a plastic laminate top surface.	
	EO-R36-AC-R EO-R36-BN-R	36" Diameter: Acrylic Edge; Round Leg Bullnose Edge; Round Leg	36" Diameter		29"	___ Lbs.	___ Cu Ft	\$ 1,156 \$ 1,350	There are two edge profiles available:
	EO-R42-AC-R EO-R42-BN-R	42" Diameter: Acrylic Edge; Round Leg Bullnose Edge; Round Leg	42" Diameter		29"	___ Lbs.	___ Cu Ft	\$ 1,206 \$ 1,438	 
	EO-R48-AC-R EO-R48-BN-R	48" Diameter: Acrylic Edge; Round Leg Bullnose Edge; Round Leg	48" Diameter		29"	___ Lbs.	___ Cu Ft	\$ 1,269 \$ 1,538	Model "AC" Acrylic Edge Model "BN" 3/4" Bullnose Edge
									Leq style available:
		SQUARE Tables;							
EO-3636-AC-R EO-3636-BN-R		36" Width: Acrylic Edge; Round Leg Bullnose Edge; Round Leg	36"	36"	29"	___ Lbs.	___ Cu Ft	\$ 1,163 \$ 1,406	
EO-4242-AC-R EO-4242-BN-R		42" Width: Acrylic Edge; Round Leg Bullnose Edge; Round Leg	42"	42"	29"	___ Lbs.	___ Cu Ft	\$ 1,219 \$ 1,500	





MODEL NUMBER	PRODUCT	WIDTH	DEPTH	HEIGHT	WEIGHT	VOLUME	LIST PRICE	DESCRIPTION	
	RECTANGLE Tables;							Each table is constructed of a 1" thick top with a plastic laminate top surface.	
		24" Depth:						There are two edge profiles available:	
	EO-3624-AC-R EO-3624-BN-R	Acrylic Edge; Round Leg Bullnose Edge; Round Leg	36"	24"	29"	___ Lbs.	___ Cu Ft	\$ 1,131 \$ 1,331	 
	EO-4824-AC-R EO-4824-BN-R	Acrylic Edge; Round Leg Bullnose Edge; Round Leg	48"	24"	29"	___ Lbs.	___ Cu Ft	\$ 1,163 \$ 1,406	
	EO-6024-AC-R EO-6024-BN-R	Acrylic Edge; Round Leg Bullnose Edge; Round Leg	60"	24"	29"	___ Lbs.	___ Cu Ft	\$ 1,200 \$ 1,481	Model "AC" Acrylic Edge
	EO-7224-AC-R EO-7224-BN-R	Acrylic Edge; Round Leg Bullnose Edge; Round Leg	72"	24"	29"	___ Lbs.	___ Cu Ft	\$ 1,238 \$ 1,563	Model "BN" 3/4" Bullnose Edge
									Leg style available:
		30" Depth:							
	EO-4830-AC-R EO-4830-BN-R	Acrylic Edge; Round Leg Bullnose Edge; Round Leg	48"	30"	29"	___ Lbs.	___ Cu Ft	\$ 1,200 \$ 1,463	
	EO-6030-AC-R EO-6030-BN-R	Acrylic Edge; Round Leg Bullnose Edge; Round Leg	60"	30"	29"	___ Lbs.	___ Cu Ft	\$ 1,338 \$ 1,644	
	EO-7230-AC-R EO-7230-BN-R	Acrylic Edge; Round Leg Bullnose Edge; Round Leg	72"	30"	29"	___ Lbs.	___ Cu Ft	\$ 1,381 \$ 1,725	
		36" Depth:							Model "R" 2 1/2" Diameter Round Leg
EO-6036-AC-R EO-6036-BN-R	Acrylic Edge; Round Leg Bullnose Edge; Round Leg	60"	36"	29"	___ Lbs.	___ Cu Ft	\$ 1,375 \$ 1,706		
EO-7236-AC-R EO-7236-BN-R	Acrylic Edge; Round Leg Bullnose Edge; Round Leg	72"	36"	29"	___ Lbs.	___ Cu Ft	\$ 1,431 \$ 1,800		
	42" Depth:								
EO-7242-AC-R EO-7242-BN-R	Acrylic Edge; Round Leg Bullnose Edge; Round Leg	72"	42"	29"	___ Lbs.	___ Cu Ft	\$ 1,475 \$ 1,869		
EO-8442-AC-R EO-8442-BN-R	Acrylic Edge; Round Leg Bullnose Edge; Round Leg	84"	42"	29"	___ Lbs.	___ Cu Ft	\$ 1,538 \$ 1,975		
EO-9642-AC-R EO-9642-BN-R	Acrylic Edge; Round Leg Bullnose Edge; Round Leg	96"	42"	29"	___ Lbs.	___ Cu Ft	\$ 1,594 \$ 2,075		

MODEL NUMBER	PRODUCT	WIDTH	DEPTH	HEIGHT	WEIGHT	VOLUME	LIST PRICE	DESCRIPTION
	TRAPEZOIDAL Tables;							Each table is constructed of a 1" thick top with a plastic laminate top surface. There are two edge profiles available:
	48" Width: EO-TZ-4824-AC-R Acrylic Edge; Round Leg EO-TZ-4824-BN-R Bullnose Edge; Round Leg	48"	24"	29"	___ Lbs.	___ Cu Ft	\$ 1,138 \$ 1,338	
	60" Width: EO-TZ-6030-AC-R Acrylic Edge; Round Leg EO-TZ-6030-BN-R Bullnose Edge; Round Leg	60"	30"	29"	___ Lbs.	___ Cu Ft	\$ 1,306 \$ 1,563	Model "AC" Acrylic Edge Model "BN" 3/4" Bullnose Edge
	RACE TRACK Tables;							Leg style available:
	72" Width: EO-RT-7242-AC-R Acrylic Edge; Round Leg EO-RT-7242-BN-R Bullnose Edge; Round Leg	72"	42"	29"	___ Lbs.	___ Cu Ft	\$ 1,650 \$ 1,988	
	84" Width: EO-RT-8442-AC-R Acrylic Edge; Round Leg EO-RT-8442-BN-R Bullnose Edge; Round Leg	84"	42"	29"	___ Lbs.	___ Cu Ft	\$ 1,706 \$ 2,088	
	96" Width: EO-RT-9642-AC-R Acrylic Edge; Round Leg EO-RT-9642-BN-R Bullnose Edge; Round Leg	96"	42"	29"	___ Lbs.	___ Cu Ft	\$ 1,769 \$ 2,188	





MODEL NUMBER	PRODUCT	WIDTH	DEPTH	HEIGHT	WEIGHT	VOLUME	LIST PRICE	DESCRIPTION	
	ROUND Tables;							<p>Each table is constructed of a 1" thick top with a plastic laminate top surface.</p> <p>There are two edge profiles available:</p> <div style="display: flex; justify-content: space-around;"> <div style="text-align: center;">  <p>Model "AC" Acrylic Edge</p> </div> <div style="text-align: center;">  <p>Model "BN" 3/4" Bullnose Edge</p> </div> </div>	
	EO-R36-AC-P EO-R36-BN-P	36" Diameter: Acrylic Edge; Pedestal Base Bullnose Edge; Pedestal Base	36" Diameter		29"	__ Lbs.	__ Cu Ft		\$1,294 \$1,488
	EO-R42-AC-P EO-R42-BN-P	42" Diameter: Acrylic Edge; Pedestal Base Bullnose Edge; Pedestal Base	42" Diameter		29"	__ Lbs.	__ Cu Ft		\$1,681 \$1,900
EO-R48-AC-P EO-R48-BN-P	48" Diameter: Acrylic Edge; Pedestal Base Bullnose Edge; Pedestal Base	48" Diameter		29"	__ Lbs.	__ Cu Ft	\$1,925 \$2,175	 <p>Model "P" Pedestal Base</p>	
	SQUARE Tables;								
EO-3636-AC-P EO-3636-BN-P	36" Width: Acrylic Edge; Pedestal Base Bullnose Edge; Pedestal Base	36"	36"	29"	__ Lbs.	__ Cu Ft	\$1,294 \$1,531		
EO-4242-AC-P EO-4242-BN-P	42" Width: Acrylic Edge; Pedestal Base Bullnose Edge; Pedestal Base	42"	42"	29"	__ Lbs.	__ Cu Ft	\$1,675 \$1,956		







MODEL NUMBER	PRODUCT	WIDTH	DEPTH	HEIGHT	WEIGHT	VOLUME	LIST PRICE	DESCRIPTION	
	RECTANGLE Tables;							Each table is constructed of a 1" thick top with a plastic laminate top surface.	
	24" Depth:							There are two edge profiles available:	
	EO-6024-AC-T EO-6024-BN-T	Acrylic Edge; T-Leg Bullnose Edge; T-Leg	60"	24"	29"	___ Lbs.	___ Cu Ft	\$ 1,206 \$ 1,488	 
	EO-7224-AC-T EO-7224-BN-T	Acrylic Edge; T-Leg Bullnose Edge; T-Leg	72"	24"	29"	___ Lbs.	___ Cu Ft	\$ 1,244 \$ 1,563	
	30" Depth:							Model "AC" Acrylic Edge	
	EO-6030-AC-T EO-6030-BN-T	Acrylic Edge; T-Leg Bullnose Edge; T-Leg	60"	30"	29"	___ Lbs.	___ Cu Ft	\$ 1,263 \$ 1,556	Model "BN" 3/4" Bullnose Edge
	EO-7230-AC-T EO-7230-BN-T	Acrylic Edge; T-Leg Bullnose Edge; T-Leg	72"	30"	29"	___ Lbs.	___ Cu Ft	\$ 1,306 \$ 1,644	
	36" Depth:								
	EO-6036-AC-T EO-6036-BN-T	Acrylic Edge; T-Leg Bullnose Edge; T-Leg	60"	36"	29"	___ Lbs.	___ Cu Ft	\$ 1,313 \$ 1,631	
	EO-7236-AC-T EO-7236-BN-T	Acrylic Edge; T-Leg Bullnose Edge; T-Leg	72"	36"	29"	___ Lbs.	___ Cu Ft	\$ 1,369 \$ 1,725	
	42" Depth:								
	EO-7242-AC-T EO-7242-BN-T	Acrylic Edge; T-Leg Bullnose Edge; T-Leg	72"	42"	29"	___ Lbs.	___ Cu Ft	\$ 1,844 \$ 2,294	
	EO-8442-AC-T EO-8442-BN-T	Acrylic Edge; T-Leg Bullnose Edge; T-Leg	84"	42"	29"	___ Lbs.	___ Cu Ft	\$ 1,981 \$ 2,400	
	EO-9642-AC-T EO-9642-BN-T	Acrylic Edge; T-Leg Bullnose Edge; T-Leg	96"	42"	29"	___ Lbs.	___ Cu Ft	\$ 2,038 \$ 2,500	
	RACE TRACK Tables;								
	42" Depth:								
	EO-RT-7242-AC-T EO-RT-7242-BN-T	Acrylic Edge; T-Leg Bullnose Edge; T-Leg	72"	42"	29"	___ Lbs.	___ Cu Ft	\$ 2,181 \$ 2,500	
	EO-RT-8442-AC-T EO-RT-8442-BN-T	Acrylic Edge; T-Leg Bullnose Edge; T-Leg	84"	42"	29"	___ Lbs.	___ Cu Ft	\$ 2,244 \$ 2,600	
EO-RT-9642-AC-T EO-RT-9642-BN-T	Acrylic Edge; T-Leg Bullnose Edge; T-Leg	96"	42"	29"	___ Lbs.	___ Cu Ft	\$ 2,300 \$ 2,700		

MODEL NUMBER	PRODUCT	WIDTH	DEPTH	HEIGHT	WEIGHT	VOLUME	LIST PRICE	DESCRIPTION	
	RECTANGLE Workstations, Acrylic Edge;							Each table is constructed of a 1" thick top with a plastic laminate top surface.	
EO-3024-AC-WS	24" Depth	30"	24"	29"	___ Lbs.	___ Cu Ft	\$ 1,200	There is one edge profile available:  Model "AC" Acrylic Edge	
EO-4824-AC-WS		48"	24"	29"	___ Lbs.	___ Cu Ft	\$ 1,319		
EO-6024-AC-WS		60"	24"	29"	___ Lbs.	___ Cu Ft	\$ 1,369		
EO-7224-AC-WS		72"	24"	29"	___ Lbs.	___ Cu Ft	\$ 1,581		
EO-4830-AC-WS	30" Depth	48"	30"	29"	___ Lbs.	___ Cu Ft	\$ 1,350		
EO-6030-AC-WS		60"	30"	29"	___ Lbs.	___ Cu Ft	\$ 1,413		
EO-7230-AC-WS		72"	30"	29"	___ Lbs.	___ Cu Ft	\$ 1,631		
	CORNER Workstations, Acrylic Edge;								
EO-C4224-AC-WS	24" Depth	42"	24"	29"	___ Lbs.	___ Cu Ft	\$ 1,344		
EO-C4830-AC-WS	30" Depth	48"	30"	29"	___ Lbs.	___ Cu Ft	\$ 1,413		
	SQUARE Workstations, Acrylic Edge;								
EO-2424-AC-WS	24" Width	24"	24"	29"	___ Lbs.	___ Cu Ft	\$ 1,175		
EO-3030-AC-WS	30" Width	30"	30"	29"	___ Lbs.	___ Cu Ft	\$ 1,225		

MODEL NUMBER	PRODUCT	WIDTH	DEPTH	HEIGHT	WEIGHT	VOLUME	LIST PRICE	DESCRIPTION
	ROUND Tables, Knife Edge:							Constructed of 1-1/8" thick 3-ply particleboard core, with 0.050" thick high pressure plastic laminate sheet on top surface. Bottom surface laminated with a 0.20" thick backing sheet.
FL-R36-KN-2SQ		36"	36"	29"	____ Lbs.	____ Cu Ft	\$ 2,206	
FL-R42-KN-2SQ		42"	42"	29"	____ Lbs.	____ Cu Ft	\$ 2,450	
FL-R48-KN-2SQ		48"	48"	29"	____ Lbs.	____ Cu Ft	\$ 2,600	
FL-R54-KN-2SQ		54"	54"	29"	____ Lbs.	____ Cu Ft	\$ 3,094	
FL-R60-KN-2SQ		60"	60"	29"	____ Lbs.	____ Cu Ft	\$ 3,469	
	SQUARE Tables, Knife Edge:							Knife Edge is 2-1/4" wide x 1-3/4" high solid wood, with a 45 miter chamfer with 1/8" radius corners.
FL-3636-KN-2SQ		36"	36"	29"	____ Lbs.	____ Cu Ft	\$ 2,206	Consists of two sets of steel legs and a top horizontal stretcher, constructed of 2" x 2" tubular 16 gauge steel. All metal is epoxy powder coated.
FL-4242-KN-2SQ		42"	42"	29"	____ Lbs.	____ Cu Ft	\$ 2,344	
FL-4848-KN-2SQ		48"	48"	29"	____ Lbs.	____ Cu Ft	\$ 2,494	
	RECTANGLE Tables, Knife Edge:							Leveler: Legs are fitted with a threaded base to accept a 1/4" thick x 2"x2" square metal adjustable glide.
FL-3036-KN-2SQ		36"	30"	29"	____ Lbs.	____ Cu Ft	\$ 2,113	
FL-3042-KN-2SQ		42"	30"	29"	____ Lbs.	____ Cu Ft	\$ 2,200	
FL-3048-KN-2SQ		48"	30"	29"	____ Lbs.	____ Cu Ft	\$ 2,269	
FL-3054-KN-2SQ		54"	30"	29"	____ Lbs.	____ Cu Ft	\$ 2,331	
FL-3060-KN-2SQ		60"	30"	29"	____ Lbs.	____ Cu Ft	\$ 2,394	
FL-3072-KN-2SQ		72"	30"	29"	____ Lbs.	____ Cu Ft	\$ 2,519	
FL-3642-KN-2SQ		42"	36"	29"	____ Lbs.	____ Cu Ft	\$ 2,275	17-3/4" I.D. for 36" Diameter 22" I.D. for 42" Diameter 26-1/4" I.D. for 48" Diameter
FL-3648-KN-2SQ		48"	36"	29"	____ Lbs.	____ Cu Ft	\$ 2,356	
FL-3654-KN-2SQ		54"	36"	29"	____ Lbs.	____ Cu Ft	\$ 2,406	
FL-3660-KN-2SQ		60"	36"	29"	____ Lbs.	____ Cu Ft	\$ 2,475	
FL-3672-KN-2SQ		72"	36"	29"	____ Lbs.	____ Cu Ft	\$ 2,606	



	MODEL NUMBER	PRODUCT	WIDTH	DEPTH	HEIGHT	WEIGHT	VOLUME	LIST PRICE	DESCRIPTION
	FL-CS-3630-KN-2SQ	COMPUTER STATIONS, Knife Edge: One Place	36"	30"	29"	____ Lbs.	____ Cu Ft	\$ 3,006	Constructed of 1-1/8" thick 3-ply particleboard core, with 0.050" thick high pressure plastic laminate sheet on top surface. Bottom surface laminated with a 0.20" thick backing sheet.
	FL-CS-D-7230-KN-2SQ	Two Place	72"	30"	29"	____ Lbs.	____ Cu Ft	\$ 3,869	Knife Edge is 2-1/4" wide x 1-3/4" high solid wood, with a 45 miter chamfer with 1/8" radius corners. Consists of two sets of steel legs and a top horizontal stretcher, constructed of 2" x 2" tubular 16 gauge steel. All metal is epoxy powder coated. Leveler: Legs are fitted with a threaded base to accept a 1/4" thick x 2"x2" square metal adjustable glide.
	FL-CS-2D-3660-KN-2SQ	Two Place, (One Place Back to Back)	36"	60"	29"	____ Lbs.	____ Cu Ft	\$ 3,619	
	FL-CS-4D-7260-KN-2SQ	Four Place, (Two Place Back to Back)	72"	60"	29"	____ Lbs.	____ Cu Ft	\$ 4,794	Clean with a non abrasive cleanser. Do not use powdered cleaning solutions as they may scratch the surface. NOTE: For all Fluid Workstations the list price includes the Acrylic Surround Screen(s), Grommet(s), and J-Channel Wire Management.

	MODEL NUMBER	PRODUCT	WIDTH	DEPTH	HEIGHT	WEIGHT	VOLUME	LIST PRICE	DESCRIPTION
	LG-T-AC-STC LG-T-SQ-STC	Table Pod Acrylic Edge Square Edge	47 1/2"	24"	29"	23 Lbs.	19.5 Cu Ft	\$ 1,000 \$ 1,038	<p>Small and Large Table Pods connect to the Center Pod to create workstations. The Pods connect on a swivel hinge allowing them to be easily adjusted to endless different user configurations.</p> <p>An optional Power Sphere connects into the top middle of the Center Pod which can supply four power outlets or two power and two data outlets.</p> <p>There are two edge profiles available:</p> <div style="display: flex; justify-content: space-around;"> <div style="text-align: center;">  <p>Model "AC" 3mm Vinyl Acrylic Edge</p> </div> <div style="text-align: center;">  <p>Model "SQ" 1/8" Square Edge</p> </div> </div>
	LG-L-AC-STC LG-L-SQ-STC	Large Table Pod Acrylic Edge Square Edge	34 1/4"	34 1/4"	29"	31 Lbs.	20 Cu Ft	\$ 1,213 \$ 1,263	
	LG-CP4-AC LG-CP4-SQ	Center Pod: Quad Acrylic Edge Square Edge	28 1/2"	28 1/2"	27 1/2"	105 Lbs.	13 Cu Ft	\$ 1,694 \$ 1,731	 <p>Model "STC" Straight Caster Leg</p>
	LG-CP3-AC LG-CP3-SQ	Center Pod: Triple Acrylic Edge Square Edge	28 1/2"	28 1/2"	27 1/2"	_____ Lbs.	_____ Cu Ft	\$ 1,650 \$ 1,681	



CONFIGURATION A: TRIPLE WORKSTATION

LG-CA-AC-STC	Acrylic Edge, Straight Caster	\$ 4,650
LG-CA-SO-STC	Square Edge, Straight Caster	\$ 4,794



**CONFIGURATION C: TRIPLE WORKSTATION,
1 LARGE & 2 SMALL PODS**

LG-CC-AC-STC	Acrylic Edge, Straight Caster	\$ 4,863
LG-CC-SO-STC	Square Edge, Straight Caster	\$ 5,019



CONFIGURATION B: QUAD WORKSTATION

LG-CB-AC-STC	Acrylic Edge, Straight Caster	\$ 5,694
LG-CB-SO-STC	Square Edge, Straight Caster	\$ 5,881

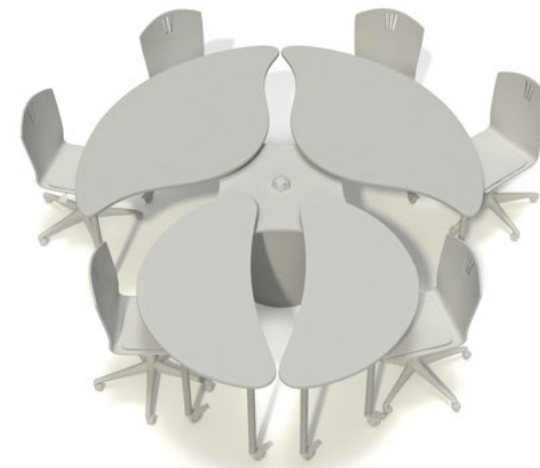

**CONFIGURATION D: QUAD WORKSTATION,
2 LARGE & 2 SMALL PODS**

LG-CD-AC-STC	Acrylic Edge, Straight Caster	\$ 6,119
LG-CD-SO-STC	Square Edge, Straight Caster	\$ 6,331

MODEL NUMBER	PRODUCT	WIDTH	DEPTH	HEIGHT	WEIGHT	VOLUME	LIST PRICE	DESCRIPTION	
	48" Width Tables;	48"	32 1/2"	29"	60.5 Lbs.	2 Cu Ft		<p>Each unit is a single user unit which can be combined together to create two and four user stations.</p> <p>There are three solid wood edge profiles available:</p>  <p>Model "PN" Model "BN" Model "SQ"</p> <p>2" Pencil Edge 1 1/4" Bullnose Edge 3/4" Square Edge</p> <p>There are two different leg styles available:</p>  <p>Model "DS" Model "SS"</p> <p>2 1/2" Diameter & Stem Leg 2" Square & Stem Leg</p>	
	LF-4832-PN-DS	Pencil Edge; Dia. & Stem Leg							\$ 2,175
	LF-4832-PN-SS	Pencil Edge; Square & Stem Leg							\$ 2,175
	LF-4832-BN-DS	Bullnose Edge; Dia. & Stem Leg							\$ 2,088
	LF-4832-BN-SS	Bullnose Edge; Square & Stem Leg							\$ 2,088
	LF-4832-SQ-DS	Square Edge; Dia. & Stem Leg							\$ 1,906
LF-4832-SQ-SS	Square Edge; Square & Stem Leg			\$ 1,906					
	60" Width Tables;	60"	44 1/2"	29"	72 Lbs.	2.5 Cu Ft		<p>There are two different leg styles available:</p>  <p>Model "DS" Model "SS"</p> <p>2 1/2" Diameter & Stem Leg 2" Square & Stem Leg</p>	
	LF-6044-PN-DS	Pencil Edge; Dia. & Stem Leg							\$ 2,363
	LF-6044-PN-SS	Pencil Edge; Square & Stem Leg							\$ 2,363
	LF-6044-BN-DS	Bullnose Edge; Dia. & Stem Leg							\$ 2,269
	LF-6044-BN-SS	Bullnose Edge; Square & Stem Leg							\$ 2,269
	LF-6044-SQ-DS	Square Edge; Dia. & Stem Leg							\$ 2,088
LF-6044-SQ-SS	Square Edge; Square & Stem Leg			\$ 2,088					

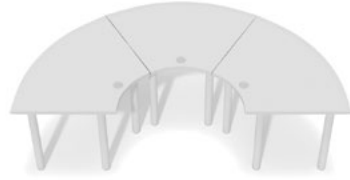

CONFIGURATION A: SEMI-CIRCLE WORKSTATION WITH 3 - 48" WIDE TABLES

LF-CA48-PN-DS	Pencil Edge; Dia. & Stem Leg	\$ 6,525
LF-CA48-PN-SS	Pencil Edge; Square & Stem Leg	\$ 6,525
LF-CA48-BN-DS	Bullnose Edge; Dia. & Stem Leg	\$ 6,263
LF-CA48-BN-SS	Bullnose Edge; Square & Stem Leg	\$ 6,263
LF-CA48-SQ-DS	Square Edge; Dia. & Stem Leg	\$ 5,719
LF-CA48-SQ-SS	Square Edge; Square & Stem Leg	\$ 5,719

CONFIGURATION A: SEMI-CIRCLE WORKSTATION WITH 3 - 60" WIDE TABLES

LF-CA60-PN-DS	Pencil Edge; Dia. & Stem Leg	\$ 7,088
LF-CA60-PN-SS	Pencil Edge; Square & Stem Leg	\$ 7,088
LF-CA60-BN-DS	Bullnose Edge; Dia. & Stem Leg	\$ 6,806
LF-CA60-BN-SS	Bullnose Edge; Square & Stem Leg	\$ 6,806
LF-CA60-SQ-DS	Square Edge; Dia. & Stem Leg	\$ 6,263
LF-CA60-SQ-SS	Square Edge; Square & Stem Leg	\$ 6,263

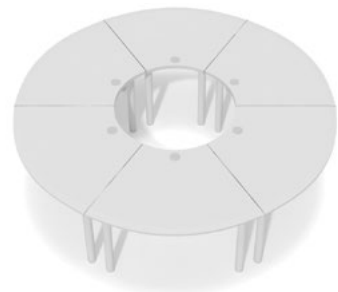

CONFIGURATION B: CIRCLE WORKSTATION WITH 6 - 48" WIDE TABLES

LF-CB48-PN-DS	Pencil Edge; Dia. & Stem Leg	\$ 13,050
LF-CB48-PN-SS	Pencil Edge; Square & Stem Leg	\$ 13,050
LF-CB48-BN-DS	Bullnose Edge; Dia. & Stem Leg	\$ 12,525
LF-CB48-BN-SS	Bullnose Edge; Square & Stem Leg	\$ 12,525
LF-CB48-SQ-DS	Square Edge; Dia. & Stem Leg	\$ 11,438
LF-CB48-SQ-SS	Square Edge; Square & Stem Leg	\$ 11,438

CONFIGURATION B: CIRCLE WORKSTATION WITH 6 - 60" WIDE TABLES

LF-CB60-PN-DS	Pencil Edge; Dia. & Stem Leg	\$ 14,175
LF-CB60-PN-SS	Pencil Edge; Square & Stem Leg	\$ 14,175
LF-CB60-BN-DS	Bullnose Edge; Dia. & Stem Leg	\$ 13,613
LF-CB60-BN-SS	Bullnose Edge; Square & Stem Leg	\$ 13,613
LF-CB60-SQ-DS	Square Edge; Dia. & Stem Leg	\$ 12,525
LF-CB60-SQ-SS	Square Edge; Square & Stem Leg	\$ 12,525



CONFIGURATION C: WORKSTATION WITH 5 - 48" WIDE TABLES

LF-CC48-PN-DS	Pencil Edge; Dia. & Stem Leg	\$ 10,875
LF-CC48-PN-SS	Pencil Edge; Square & Stem Leg	\$ 10,875
LF-CC48-BN-DS	Bullnose Edge; Dia. & Stem Leg	\$ 10,438
LF-CC48-BN-SS	Bullnose Edge; Square & Stem Leg	\$ 10,438
LF-CC48-SQ-DS	Square Edge; Dia. & Stem Leg	\$ 9,531
LF-CC48-SQ-SS	Square Edge; Square & Stem Leg	\$ 9,531

CONFIGURATION C: WORKSTATION WITH 5 - 60" WIDE TABLES

LF-CC60-PN-DS	Pencil Edge; Dia. & Stem Leg	\$ 11,813
LF-CC60-PN-SS	Pencil Edge; Square & Stem Leg	\$ 11,813
LF-CC60-BN-DS	Bullnose Edge; Dia. & Stem Leg	\$ 11,344
LF-CC60-BN-SS	Bullnose Edge; Square & Stem Leg	\$ 11,344
LF-CC60-SQ-DS	Square Edge; Dia. & Stem Leg	\$ 10,438
LF-CC60-SQ-SS	Square Edge; Square & Stem Leg	\$ 10,438











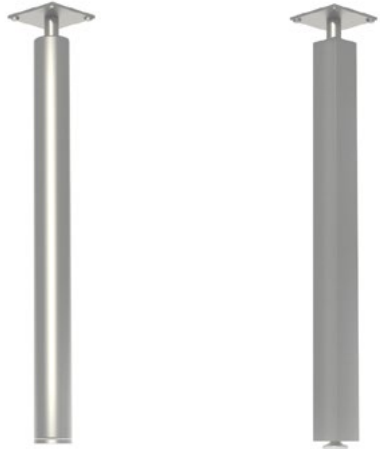

CONFIGURATION D: WORKSTATION WITH 6 - 48" WIDE TABLES







LF-CD48-PN-DS	Pencil Edge; Dia. & Stem Leg	\$ 13,050
LF-CD48-PN-SS	Pencil Edge; Square & Stem Leg	\$ 13,050
LF-CD48-BN-DS	Bullnose Edge; Dia. & Stem Leg	\$ 12,525
LF-CD48-BN-SS	Bullnose Edge; Square & Stem Leg	\$ 12,525
LF-CD48-SQ-DS	Square Edge; Dia. & Stem Leg	\$ 11,438
LF-CD48-SQ-SS	Square Edge; Square & Stem Leg	\$ 11,438



CONFIGURATION D: WORKSTATION WITH 6 - 60" WIDE TABLES

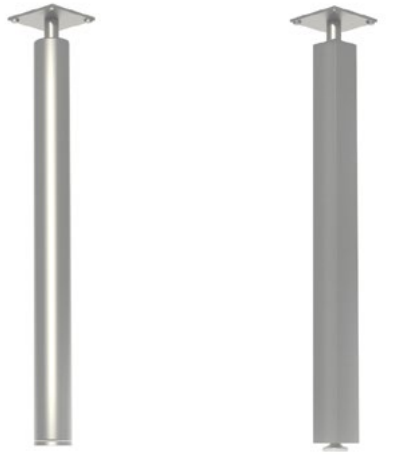



LF-CD60-PN-DS	Pencil Edge; Dia. & Stem Leg	\$ 14,175
LF-CD60-PN-SS	Pencil Edge; Square & Stem Leg	\$ 14,175
LF-CD60-BN-DS	Bullnose Edge; Dia. & Stem Leg	\$ 13,613
LF-CD60-BN-SS	Bullnose Edge; Square & Stem Leg	\$ 13,613
LF-CD60-SQ-DS	Square Edge; Dia. & Stem Leg	\$ 12,525
LF-CD60-SQ-SS	Square Edge; Square & Stem Leg	\$ 12,525

MODEL NUMBER	PRODUCT	WIDTH	DEPTH	HEIGHT	WEIGHT	VOLUME	LIST PRICE	DESCRIPTION
	48" Width Tables;	48"	48"	29"	60.5 Lbs.	2 Cu Ft		<p>Each unit is a single user unit which can be combined together to create two and four user stations.</p> <p>There are three solid wood edge profiles available:</p>  <p>Model "PN" 2" Pencil Edge</p> <p>Model "BN" 1 1/4" Bullnose Edge</p> <p>Model "SQ" 3/4" Square Edge</p> <p>There is an option for a Grommet and Wire Management leg for this table. In addition to the above, there is also a 1/4" thick frosted acrylic divider screen available for this table.</p> <p>There are two different leg styles available:</p>  <p>Model "R" 2 1/2" Diameter & Stem Leg</p> <p>Model "S" 2" Square & Stem Leg</p>
	PD-T4848-PN-R	Pencil Edge; Dia. & Stem Leg					\$ 2,000	
	PD-T4848-PN-S	Pencil Edge; Square & Stem Leg					\$ 2,000	
	PD-T4848-BN-R	Bullnose Edge; Dia. & Stem Leg					\$ 2,094	
	PD-T4848-BN-S	Bullnose Edge; Square & Stem Leg					\$ 2,094	
	PD-T4848-SQ-R	Square Edge; Dia. & Stem Leg					\$ 2,050	
PD-T4848-SQ-S	Square Edge; Square & Stem Leg					\$ 2,050		
	60" Width Tables;	60"	60"	29"	72 Lbs.	2.5 Cu Ft		
	PD-T6060-PN-R	Pencil Edge; Dia. & Stem Leg					\$ 2,175	
	PD-T6060-PN-S	Pencil Edge; Square & Stem Leg					\$ 2,175	
	PD-T6060-BN-R	Bullnose Edge; Dia. & Stem Leg					\$ 2,269	
	PD-T6060-BN-S	Bullnose Edge; Square & Stem Leg					\$ 2,269	
	PD-T6060-SQ-R	Square Edge; Dia. & Stem Leg					\$ 2,225	
PD-T6060-SQ-S	Square Edge; Square & Stem Leg					\$ 2,225		
	48" Width Tables; 1 Grommet; 1 Wire Management Leg;	48"	48"	29"	60.5 Lbs.	2 Cu Ft		
	PD-T4848-PN-R-GW	Pencil Edge; Dia. & Stem Leg					\$ 2,119	
	PD-T4848-PN-S-GW	Pencil Edge; Square & Stem Leg					\$ 2,119	
	PD-T4848-BN-R-GW	Bullnose Edge; Dia. & Stem Leg					\$ 2,213	
	PD-T4848-BN-S-GW	Bullnose Edge; Square & Stem Leg					\$ 2,213	
	PD-T4848-SQ-R-GW	Square Edge; Dia. & Stem Leg					\$ 2,169	
PD-T4848-SQ-S-GW	Square Edge; Square & Stem Leg					\$ 2,169		
	60" Width Tables; 1 Grommet; 1 Wire Management Leg;	60"	60"	29"	72 Lbs.	2.5 Cu Ft		
	PD-T6060-PN-R-GW	Pencil Edge; Dia. & Stem Leg					\$ 2,294	
	PD-T6060-PN-S-GW	Pencil Edge; Square & Stem Leg					\$ 2,294	
	PD-T6060-BN-R-GW	Bullnose Edge; Dia. & Stem Leg					\$ 2,388	
	PD-T6060-BN-S-GW	Bullnose Edge; Square & Stem Leg					\$ 2,388	
	PD-T6060-SQ-R-GW	Square Edge; Dia. & Stem Leg					\$ 2,344	
PD-T6060-SQ-S-GW	Square Edge; Square & Stem Leg					\$ 2,344		

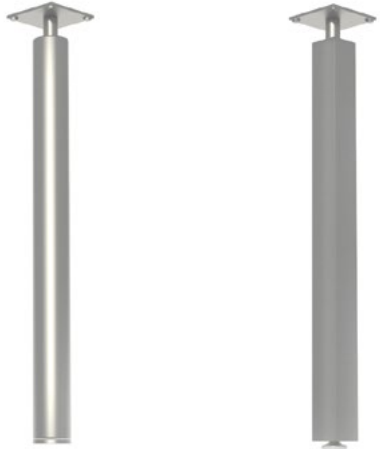





MODEL NUMBER	PRODUCT	WIDTH	DEPTH	HEIGHT	WEIGHT	VOLUME	LIST PRICE	DESCRIPTION
	48" Width Tables; 1 Grommet; 1 Wire Management Leg; 2 Acrylic Dividers;	48"	48"	29"	64 Lbs.	2 Cu Ft		Each unit is a single user unit which can be combined together to create two and four user stations. There are three solid wood edge profiles available:
	PD-T4848-PN-R-GWA Pencil Edge; Dia. & Stem Leg						\$ 2,781	
	PD-T4848-PN-S-GWA Pencil Edge; Square & Stem Leg						\$ 2,781	
	PD-T4848-BN-R-GWA Bullnose Edge; Dia. & Stem Leg						\$ 2,875	
	PD-T4848-BN-S-GWA Bullnose Edge; Square & Stem Leg						\$ 2,875	
	PD-T4848-SQ-R-GWA Square Edge; Dia. & Stem Leg						\$ 2,831	
	PD-T4848-SQ-S-GWA Square Edge; Square & Stem Leg						\$ 2,831	
	60" Width Tables; 1 Grommet; 1 Wire Management Leg; 2 Acrylic Dividers;	60"	60"	29"	76 Lbs.	2.5 Cu Ft		There is an option for a Grommet and Wire Management leg for this table. In addition to the above, there is also a 1/4" thick frosted acrylic divider screen available for this table.
PD-T6060-PN-R-GWA Pencil Edge; Dia. & Stem Leg							\$ 2,956	
PD-T6060-PN-S-GWA Pencil Edge; Square & Stem Leg							\$ 2,956	
PD-T6060-BN-R-GWA Bullnose Edge; Dia. & Stem Leg							\$ 3,050	
PD-T6060-BN-S-GWA Bullnose Edge; Square & Stem Leg							\$ 3,050	
PD-T6060-SQ-R-GWA Square Edge; Dia. & Stem Leg							\$ 3,006	
PD-T6060-SQ-S-GWA Square Edge; Square & Stem Leg							\$ 3,006	
								There are two different leg styles available:
								
								Model "R" 2 1/2" Diameter & Stem Leg
								Model "S" 2" Square & Stem Leg

MODEL NUMBER	PRODUCT	WIDTH	DEPTH	HEIGHT	WEIGHT	VOLUME	LIST PRICE	DESCRIPTION
	2 PERSON Unit: 48" Depth;	96"	48"	29"	_____ Lbs.	_____ Cu Ft		<p>Each unit is a single user unit which can be combined together to create two and four user stations.</p> <p>There are three solid wood edge profiles available:</p>  <p>Model "PN" 2" Pencil Edge</p> <p>Model "BN" 1 1/4" Bullnose Edge</p> <p>Model "SQ" 3/4" Square Edge</p> <p>There is an option for a Grommet and Wire Management leg for this table. In addition to the above, there is also a 1/4" thick frosted acrylic divider screen available for this table.</p> <p>There are two different leg styles available:</p>  <p>Model "R" 2 1/2" Diameter & Stem Leg</p> <p>Model "S" 2" Square & Stem Leg</p>
	PD-CB48-PN-R	Pencil Edge; Dia. & Stem Leg					\$ 3,425	
	PD-CB48-PN-S	Pencil Edge; Square & Stem Leg					\$ 3,425	
	PD-CB48-BN-R	Bullnose Edge; Dia. & Stem Leg					\$ 3,613	
	PD-CB48-BN-S	Bullnose Edge; Square & Stem Leg					\$ 3,613	
	PD-CB48-SQ-R	Square Edge; Dia. & Stem Leg					\$ 3,519	
PD-CB48-SQ-S	Square Edge; Square & Stem Leg					\$ 3,519		
	2 PERSON Unit: 60" Depth;	120"	60"	29"	_____ Lbs.	_____ Cu Ft		
	PD-CB60-PN-R	Pencil Edge; Dia. & Stem Leg					\$ 3,769	
	PD-CB60-PN-S	Pencil Edge; Square & Stem Leg					\$ 3,769	
	PD-CB60-BN-R	Bullnose Edge; Dia. & Stem Leg					\$ 3,956	
	PD-CB60-BN-S	Bullnose Edge; Square & Stem Leg					\$ 3,956	
	PD-CB60-SQ-R	Square Edge; Dia. & Stem Leg					\$ 3,863	
PD-CB60-SQ-S	Square Edge; Square & Stem Leg					\$ 3,863		
	2 PERSON Unit: 48" Depth; 2 Grommets; 1 Wire Management Leg;	96"	48"	29"	_____ Lbs.	_____ Cu Ft		
	PD-CB48-PN-R-GW	Pencil Edge; Dia. & Stem Leg					\$ 3,650	
	PD-CB48-PN-S-GW	Pencil Edge; Square & Stem Leg					\$ 3,650	
	PD-CB48-BN-R-GW	Bullnose Edge; Dia. & Stem Leg					\$ 3,838	
	PD-CB48-BN-S-GW	Bullnose Edge; Square & Stem Leg					\$ 3,838	
	PD-CB48-SQ-R-GW	Square Edge; Dia. & Stem Leg					\$ 3,744	
PD-CB48-SQ-S-GW	Square Edge; Square & Stem Leg					\$ 3,744		
	2 PERSON Unit: 60" Depth; 2 Grommets; 1 Wire Management Leg;	120"	60"	29"	_____ Lbs.	_____ Cu Ft		
	PD-CB60-PN-R-GW	Pencil Edge; Dia. & Stem Leg					\$ 3,994	
	PD-CB60-PN-S-GW	Pencil Edge; Square & Stem Leg					\$ 3,994	
	PD-CB60-BN-R-GW	Bullnose Edge; Dia. & Stem Leg					\$ 4,181	
	PD-CB60-BN-S-GW	Bullnose Edge; Square & Stem Leg					\$ 4,181	
	PD-CB60-SQ-R-GW	Square Edge; Dia. & Stem Leg					\$ 4,088	
PD-CB60-SQ-S-GW	Square Edge; Square & Stem Leg					\$ 4,088		

MODEL NUMBER	PRODUCT	WIDTH	DEPTH	HEIGHT	WEIGHT	VOLUME	LIST PRICE	DESCRIPTION
	2 PERSON Unit: 48" Depth; 2 Grommets; 1 Wire Management Leg; 3 Acrylic Dividers;	96"	48"	29"	_____ Lbs.	_____ Cu Ft		Each unit is a single user unit which can be combined together to create two and four user stations. There are three solid wood edge profiles available:
PD-CB48-PN-R-GWA	Pencil Edge; Dia. & Stem Leg						\$ 4,644	
PD-CB48-PN-S-GWA	Pencil Edge; Square & Stem Leg					\$ 4,644		
PD-CB48-BN-R-GWA	Bullnose Edge; Dia. & Stem Leg					\$ 4,831		
PD-CB48-BN-S-GWA	Bullnose Edge; Square & Stem Leg					\$ 4,831		
PD-CB48-SQ-R-GWA	Square Edge; Dia. & Stem Leg					\$ 4,738		
PD-CB48-SQ-S-GWA	Square Edge; Square & Stem Leg					\$ 4,738		
	2 PERSON Unit: 60" Depth; 2 Grommets; 1 Wire Management Leg; 3 Acrylic Dividers;	120"	60"	29"	_____ Lbs.	_____ Cu Ft		There is an option for a Grommet and Wire Management leg for this table. In addition to the above, there is also a 1/4" thick frosted acrylic divider screen available for this table.
PD-CB60-PN-R-GWA	Pencil Edge; Dia. & Stem Leg						\$ 4,988	<p>There are two different leg styles available:</p> 
PD-CB60-PN-S-GWA	Pencil Edge; Square & Stem Leg					\$ 4,988		
PD-CB60-BN-R-GWA	Bullnose Edge; Dia. & Stem Leg					\$ 5,175		
PD-CB60-BN-S-GWA	Bullnose Edge; Square & Stem Leg					\$ 5,175		
PD-CB60-SQ-R-GWA	Square Edge; Dia. & Stem Leg					\$ 5,081		
PD-CB60-SQ-S-GWA	Square Edge; Square & Stem Leg					\$ 5,081		
								<p>Model "R" 2 1/2" Diameter & Stem Leg</p> <p>Model "S" 2" Square & Stem Leg</p>

MODEL NUMBER	PRODUCT	WIDTH	DEPTH	HEIGHT	WEIGHT	VOLUME	LIST PRICE	DESCRIPTION
	4 PERSON UNIT: Shared Leg; 48" Depth;	96"	96"	29"	_____ Lbs.	_____ Cu Ft		<p>Each unit is a single user unit which can be combined together to create two and four user stations.</p> <p>There are three solid wood edge profiles available:</p>  <p>Model "PN" 2" Pencil Edge Model "BN" 1 1/4" Bullnose Edge Model "SQ" 3/4" Square Edge</p> <p>There is an option for a Grommet and Wire Management leg for this table. In addition to the above, there is also a 1/4" thick frosted acrylic divider screen available for this table.</p> <p>There are two different leg styles available:</p>  <p>Model "R" 2 1/2" Diameter & Stem Leg Model "S" 2" Square & Stem Leg</p>
	PD-CE48-PN-R	Pencil Edge; Dia. & Stem Leg					\$ 5,500	
	PD-CE48-PN-S	Pencil Edge; Square & Stem Leg					\$ 5,500	
	PD-CE48-BN-R	Bullnose Edge; Dia. & Stem Leg					\$ 5,881	
	PD-CE48-BN-S	Bullnose Edge; Square & Stem Leg					\$ 5,881	
	PD-CE48-SQ-R	Square Edge; Dia. & Stem Leg					\$ 5,688	
PD-CE48-SQ-S	Square Edge; Square & Stem Leg					\$ 5,688		
	4 PERSON UNIT: Shared Leg; 60" Depth;	120"	120"	29"	_____ Lbs.	_____ Cu Ft		<p>4 PERSON UNIT: Shared Leg; 48" Depth; 4 Grommets; 1 Wire Management Leg;</p> <p>PD-CE48-PN-R-GW Pencil Edge; Dia. & Stem Leg \$ 5,938</p> <p>PD-CE48-PN-S-GW Pencil Edge; Square & Stem Leg \$ 5,938</p> <p>PD-CE48-BN-R-GW Bullnose Edge; Dia. & Stem Leg \$ 6,319</p> <p>PD-CE48-BN-S-GW Bullnose Edge; Square & Stem Leg \$ 6,319</p> <p>PD-CE48-SQ-R-GW Square Edge; Dia. & Stem Leg \$ 6,125</p> <p>PD-CE48-SQ-S-GW Square Edge; Square & Stem Leg \$ 6,125</p> <p>4 PERSON UNIT: Shared Leg; 60" Depth; 4 Grommets; 1 Wire Management Leg;</p> <p>PD-CE60-PN-R-GW Pencil Edge; Dia. & Stem Leg \$ 6,625</p> <p>PD-CE60-PN-S-GW Pencil Edge; Square & Stem Leg \$ 6,625</p> <p>PD-CE60-BN-R-GW Bullnose Edge; Dia. & Stem Leg \$ 7,006</p> <p>PD-CE60-BN-S-GW Bullnose Edge; Square & Stem Leg \$ 7,006</p> <p>PD-CE60-SQ-R-GW Square Edge; Dia. & Stem Leg \$ 6,819</p> <p>PD-CE60-SQ-S-GW Square Edge; Square & Stem Leg \$ 6,819</p>
	PD-CE60-PN-R	Pencil Edge; Dia. & Stem Leg					\$ 6,188	
	PD-CE60-PN-S	Pencil Edge; Square & Stem Leg					\$ 6,188	
	PD-CE60-BN-R	Bullnose Edge; Dia. & Stem Leg					\$ 6,569	
	PD-CE60-BN-S	Bullnose Edge; Square & Stem Leg					\$ 6,569	
	PD-CE60-SQ-R	Square Edge; Dia. & Stem Leg					\$ 6,381	
PD-CE60-SQ-S	Square Edge; Square & Stem Leg					\$ 6,381		

MODEL NUMBER	PRODUCT	WIDTH	DEPTH	HEIGHT	WEIGHT	VOLUME	LIST PRICE	DESCRIPTION
	4 PERSON UNIT: Shared Leg; 48" Depth; 4 Grommets; 1 Wire Management Leg; 4 Acrylic Dividers;	96"	96"	29"	_____ Lbs.	_____ Cu Ft		<p>Each unit is a single user unit which can be combined together to create two and four user stations.</p> <p>There are three solid wood edge profiles available:</p>  <p>Model "PN" Model "BN" Model "SQ"</p> <p>2" Pencil Edge 1 1/4" Bullnose Edge 3/4" Square Edge</p> <p>There is an option for a Grommet and Wire Management leg for this table. In addition to the above, there is also a 1/4" thick frosted acrylic divider screen available for this table.</p> <p>There are two different leg styles available:</p>  <p>Model "R" Model "S"</p> <p>2 1/2" Diameter & Stem Leg 2" Square & Stem Leg</p>
	PD-CE48-PN-R-GWA	Pencil Edge; Dia. & Stem Leg					\$ 7,263	
	PD-CE48-PN-S-GWA	Pencil Edge; Square & Stem Leg					\$ 7,263	
	PD-CE48-BN-R-GWA	Bullnose Edge; Dia. & Stem Leg					\$ 7,644	
	PD-CE48-BN-S-GWA	Bullnose Edge; Square & Stem Leg					\$ 7,644	
	PD-CE48-SQ-R-GWA	Square Edge; Dia. & Stem Leg					\$ 7,450	
	PD-CE48-SQ-S-GWA	Square Edge; Square & Stem Leg					\$ 7,450	
	4 PERSON UNIT: Shared Leg; 60" Depth; 4 Grommets; 1 Wire Management Leg; 4 Acrylic Dividers;	120"	120"	29"	_____ Lbs.	_____ Cu Ft		
	PD-CE60-PN-R-GWA	Pencil Edge; Dia. & Stem Leg					\$ 7,950	
	PD-CE60-PN-S-GWA	Pencil Edge; Square & Stem Leg					\$ 7,950	
	PD-CE60-BN-R-GWA	Bullnose Edge; Dia. & Stem Leg					\$ 8,331	
	PD-CE60-BN-S-GWA	Bullnose Edge; Square & Stem Leg					\$ 8,331	
	PD-CE60-SQ-R-GWA	Square Edge; Dia. & Stem Leg					\$ 8,144	
	PD-CE60-SQ-S-GWA	Square Edge; Square & Stem Leg					\$ 8,144	

MODEL NUMBER	PRODUCT	WIDTH	DEPTH	HEIGHT	WEIGHT	VOLUME	LIST PRICE	DESCRIPTION
	4 PERSON UNIT: Individual Tables; 48" Depth;	96"	96"	29"	_____ Lbs.	_____ Cu Ft		<p>Each unit is a single user unit which can be combined together to create two and four user stations.</p> <p>There are three solid wood edge profiles available:</p>  <p>Model "PN" 2" Pencil Edge Model "BN" 1 1/4" Bullnose Edge Model "SQ" 3/4" Square Edge</p> <p>There is an option for a Grommet and Wire Management leg for this table. In addition to the above, there is also a 1/4" thick frosted acrylic divider screen available for this table.</p> <p>There are two different leg styles available:</p>  <p>Model "R" 2 1/2" Diameter & Stem Leg Model "S" 2" Square & Stem Leg</p>
	PD-CA48-PN-R	Pencil Edge; Dia. & Stem Leg					\$ 8,000	
	PD-CA48-PN-S	Pencil Edge; Square & Stem Leg					\$ 8,000	
	PD-CA48-BN-R	Bullnose Edge; Dia. & Stem Leg					\$ 8,375	
	PD-CA48-BN-S	Bullnose Edge; Square & Stem Leg					\$ 8,375	
	PD-CA48-SQ-R	Square Edge; Dia. & Stem Leg					\$ 8,200	
PD-CA48-SQ-S	Square Edge; Square & Stem Leg					\$ 8,200		
	4 PERSON UNIT: Individual Tables; 60" Depth;	120"	120"	29"	_____ Lbs.	_____ Cu Ft		<p>There is an option for a Grommet and Wire Management leg for this table. In addition to the above, there is also a 1/4" thick frosted acrylic divider screen available for this table.</p>
	PD-CA60-PN-R	Pencil Edge; Dia. & Stem Leg					\$ 8,700	
	PD-CA60-PN-S	Pencil Edge; Square & Stem Leg					\$ 8,700	
	PD-CA60-BN-R	Bullnose Edge; Dia. & Stem Leg					\$ 9,075	
	PD-CA60-BN-S	Bullnose Edge; Square & Stem Leg					\$ 9,075	
	PD-CA60-SQ-R	Square Edge; Dia. & Stem Leg					\$ 8,900	
PD-CA60-SQ-S	Square Edge; Square & Stem Leg					\$ 8,900		
	4 PERSON UNIT: Individual Tables; 48" Depth; 4 Grommets; 4 Wire Management Legs;	96"	96"	29"	_____ Lbs.	_____ Cu Ft		<p>There is an option for a Grommet and Wire Management leg for this table. In addition to the above, there is also a 1/4" thick frosted acrylic divider screen available for this table.</p>
	PD-CA48-PN-R-GW	Pencil Edge; Dia. & Stem Leg					\$ 8,475	
	PD-CA48-PN-S-GW	Pencil Edge; Square & Stem Leg					\$ 8,475	
	PD-CA48-BN-R-GW	Bullnose Edge; Dia. & Stem Leg					\$ 8,850	
	PD-CA48-BN-S-GW	Bullnose Edge; Square & Stem Leg					\$ 8,850	
	PD-CA48-SQ-R-GW	Square Edge; Dia. & Stem Leg					\$ 8,675	
PD-CA48-SQ-S-GW	Square Edge; Square & Stem Leg					\$ 8,675		
	4 PERSON UNIT: Individual Tables; 60" Depth; 4 Grommets; 4 Wire Management Legs;	120"	120"	29"	_____ Lbs.	_____ Cu Ft		<p>There is an option for a Grommet and Wire Management leg for this table. In addition to the above, there is also a 1/4" thick frosted acrylic divider screen available for this table.</p>
	PD-CA60-PN-R-GW	Pencil Edge; Dia. & Stem Leg					\$ 9,175	
	PD-CA60-PN-S-GW	Pencil Edge; Square & Stem Leg					\$ 9,175	
	PD-CA60-BN-R-GW	Bullnose Edge; Dia. & Stem Leg					\$ 9,550	
	PD-CA60-BN-S-GW	Bullnose Edge; Square & Stem Leg					\$ 9,550	
	PD-CA60-SQ-R-GW	Square Edge; Dia. & Stem Leg					\$ 9,375	
PD-CA60-SQ-S-GW	Square Edge; Square & Stem Leg					\$ 9,375		

MODEL NUMBER	PRODUCT	WIDTH	DEPTH	HEIGHT	WEIGHT	VOLUME	LIST PRICE	DESCRIPTION
	4 PERSON UNIT: Individual Tables; 48" Depth; 4 Grommets; 4 Wire Management Legs; 8 Acrylic Dividers;	96"	96"	29"	_____ Lbs.	_____ Cu Ft		<p>Each unit is a single user unit which can be combined together to create two and four user stations.</p> <p>There are three solid wood edge profiles available:</p>  <p>Model "PN" 2" Pencil Edge Model "BN" 1 1/4" Bullnose Edge Model "SQ" 3/4" Square Edge</p> <p>There is an option for a Grommet and Wire Management leg for this table. In addition to the above, there is also a 1/4" thick frosted acrylic divider screen available for this table.</p> <p>There are two different leg styles available:</p>  <p>Model "R" 2 1/2" Diameter & Stem Leg Model "S" 2" Square & Stem Leg</p>
	PD-CA48-PN-R-GWA	Pencil Edge; Dia. & Stem Leg					\$ 11,125	
	PD-CA48-PN-S-GWA	Pencil Edge; Square & Stem Leg					\$ 11,125	
	PD-CA48-BN-R-GWA	Bullnose Edge; Dia. & Stem Leg					\$ 11,500	
	PD-CA48-BN-S-GWA	Bullnose Edge; Square & Stem Leg					\$ 11,500	
	PD-CA48-SQ-R-GWA	Square Edge; Dia. & Stem Leg					\$ 11,325	
	PD-CA48-SQ-S-GWA	Square Edge; Square & Stem Leg					\$ 11,325	
	4 PERSON UNIT: Individual Tables; 60" Depth; 4 Grommets; 4 Wire Management Leg;s 8 Acrylic Dividers;	120"	120"	29"	_____ Lbs.	_____ Cu Ft		
	PD-CA60-PN-R-GWA	Pencil Edge; Dia. & Stem Leg					\$ 11,825	
	PD-CA60-PN-S-GWA	Pencil Edge; Square & Stem Leg					\$ 11,825	
	PD-CA60-BN-R-GWA	Bullnose Edge; Dia. & Stem Leg					\$ 12,200	
	PD-CA60-BN-S-GWA	Bullnose Edge; Square & Stem Leg					\$ 12,200	
	PD-CA60-SQ-R-GWA	Square Edge; Dia. & Stem Leg					\$ 12,025	
	PD-CA60-SQ-S-GWA	Square Edge; Square & Stem Leg					\$ 12,025	

MODEL NUMBER

PRODUCT

WIDTH

DEPTH

HEIGHT

WEIGHT

VOLUME

LIST PRICE

DESCRIPTION



6 PERSON UNIT: 48" Depth;

96"

48"

29"

____ Lbs.

____ Cu Ft

PD-CG48-PN-R
PD-CG48-PN-S
PD-CG48-BN-R
PD-CG48-BN-S
PD-CG48-SQ-R
PD-CG48-SQ-S

Pencil Edge; Dia. & Stem Leg
Pencil Edge; Square & Stem Leg
Bullnose Edge; Dia. & Stem Leg
Bullnose Edge; Square & Stem Leg
Square Edge; Dia. & Stem Leg
Square Edge; Square & Stem Leg

\$ 5,456
\$ 5,456
\$ 5,775
\$ 5,775
\$ 5,613
\$ 5,613

Each unit is a single user unit which can be combined together to create two and four user stations.

There are three solid wood edge profiles available:



Model "PN"
2" Pencil Edge

Model "BN"
1 1/4" Bullnose Edge

Model "SQ"
3/4" Square Edge

6 PERSON UNIT: 60" Depth;

108"

60"

29"

____ Lbs.

____ Cu Ft

PD-CG60-PN-R
PD-CG60-PN-S
PD-CG60-BN-R
PD-CG60-BN-S
PD-CG60-SQ-R
PD-CG60-SQ-S

Pencil Edge; Dia. & Stem Leg
Pencil Edge; Square & Stem Leg
Bullnose Edge; Dia. & Stem Leg
Bullnose Edge; Square & Stem Leg
Square Edge; Dia. & Stem Leg
Square Edge; Square & Stem Leg

\$ 6,675
\$ 6,675
\$ 7,038
\$ 7,038
\$ 6,856
\$ 6,856

There is an option for a Grommet and Wire Management leg for this table. In addition to the above, there is also a 1/2" thick frosted acrylic divider screen with courtesy shelf option available for this table.

There are two different leg styles available:

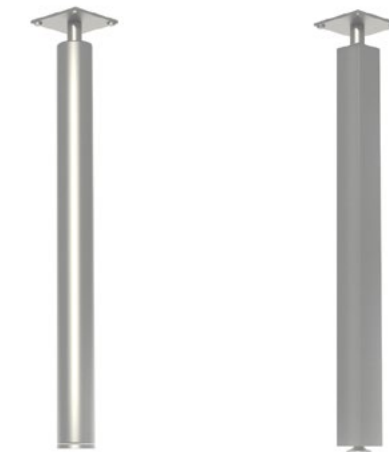

Model "R"
2 1/2" Diameter
& Stem Leg

Model "S"
2" Square
& Stem Leg



6 PERSON UNIT: 48" Depth;
6 Grommets;
2 Wire Management Legs;

96"

48"

29"

____ Lbs.

____ Cu Ft

PD-CG48-PN-R-GW
PD-CG48-PN-S-GW
PD-CG48-BN-R-GW
PD-CG48-BN-S-GW
PD-CG48-SQ-R-GW
PD-CG48-SQ-S-GW

Pencil Edge; Dia. & Stem Leg
Pencil Edge; Square & Stem Leg
Bullnose Edge; Dia. & Stem Leg
Bullnose Edge; Square & Stem Leg
Square Edge; Dia. & Stem Leg
Square Edge; Square & Stem Leg

\$ 6,119
\$ 6,119
\$ 6,438
\$ 6,438
\$ 6,275
\$ 6,275

6 PERSON UNIT: 60" Depth;
6 Grommets;
2 Wire Management Legs;

108"

60"

29"



____ Lbs.











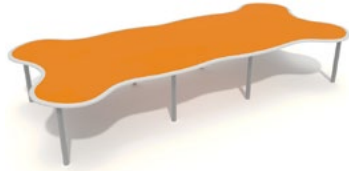



____ Cu Ft



PD-CG60-PN-R-GW
PD-CG60-PN-S-GW
PD-CG60-BN-R-GW
PD-CG60-BN-S-GW
PD-CG60-SQ-R-GW
PD-CG60-SQ-S-GW











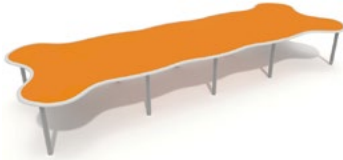



Pencil Edge; Dia. & Stem Leg
Pencil Edge; Square & Stem Leg
Bullnose Edge; Dia. & Stem Leg
Bullnose Edge; Square & Stem Leg
Square Edge; Dia. & Stem Leg
Square Edge; Square & Stem Leg

\$ 7,338
\$ 7,338
\$ 7,700
\$ 7,700
\$ 7,519
\$ 7,519

MODEL NUMBER	PRODUCT	WIDTH	DEPTH	HEIGHT	WEIGHT	VOLUME	LIST PRICE	DESCRIPTION
	6 PERSON UNIT: 48" Depth; 6 Grommets; 2 Wire Management Legs; Acrylic Dividers with top Shelf;	96"	48"	29"	_____ Lbs.	_____ Cu Ft		<p>Each unit is a single user unit which can be combined together to create two and four user stations.</p> <p>There are three solid wood edge profiles available:</p> <div style="display: flex; justify-content: space-around; align-items: flex-start;"> <div style="text-align: center;">  <p>Model "PN" 2" Pencil Edge</p> </div> <div style="text-align: center;">  <p>Model "BN" 1 1/4" Bullnose Edge</p> </div> <div style="text-align: center;">  <p>Model "SQ" 3/4" Square Edge</p> </div> </div> <p>There is an option for a Grommet and Wire Management leg for this table. In addition to the above, there is also a 1/2" thick frosted acrylic divider screen with courtesy shelf option available for this table.</p> <p>There are two different leg styles available:</p> <div style="display: flex; justify-content: space-around; align-items: flex-start;"> <div style="text-align: center;">  <p>Model "R" 2 1/2" Diameter & Stem Leg</p> </div> <div style="text-align: center;">  <p>Model "S" 2" Square & Stem Leg</p> </div> </div>
	PD-CG48-PN-R-GWA	Pencil Edge; Dia. & Stem Leg						\$ 7,263
	PD-CG48-PN-S-GWA	Pencil Edge; Square & Stem Leg						\$ 7,263
	PD-CG48-BN-R-GWA	Bullnose Edge; Dia. & Stem Leg						\$ 7,581
	PD-CG48-BN-S-GWA	Bullnose Edge; Square & Stem Leg						\$ 7,581
	PD-CG48-SQ-R-GWA	Square Edge; Dia. & Stem Leg						\$ 7,419
	PD-CG48-SQ-S-GWA	Square Edge; Square & Stem Leg						\$ 7,419
	6 PERSON UNIT: 60" Depth; 6 Grommets; 2 Wire Management Legs; Acrylic Dividers with top Shelf;	108"	60"	29"	_____ Lbs.	_____ Cu Ft		
PD-CG60-PN-R-GWA	Pencil Edge; Dia. & Stem Leg						\$ 8,481	
PD-CG60-PN-S-GWA	Pencil Edge; Square & Stem Leg						\$ 8,481	
PD-CG60-BN-R-GWA	Bullnose Edge; Dia. & Stem Leg						\$ 8,844	
PD-CG60-BN-S-GWA	Bullnose Edge; Square & Stem Leg						\$ 8,844	
PD-CG60-SQ-R-GWA	Square Edge; Dia. & Stem Leg						\$ 8,663	
PD-CG60-SQ-S-GWA	Square Edge; Square & Stem Leg						\$ 8,663	







MODEL NUMBER	PRODUCT	WIDTH	DEPTH	HEIGHT	WEIGHT	VOLUME	LIST PRICE	DESCRIPTION	
	8 PERSON UNIT: 48" Depth;	132"	48"	29"	_____ Lbs.	_____ Cu Ft		<p>Each unit is a single user unit which can be combined together to create two and four user stations.</p> <p>There are three solid wood edge profiles available:</p> <div style="display: flex; justify-content: space-around; align-items: center;"> <div style="text-align: center;">  <p>Model "PN" 2" Pencil Edge</p> </div> <div style="text-align: center;">  <p>Model "BN" 1 1/4" Bullnose Edge</p> </div> <div style="text-align: center;">  <p>Model "SQ" 3/4" Square Edge</p> </div> </div> <p>There is an option for a Grommet and Wire Management leg for this table. In addition to the above, there is also a 1/2" thick frosted acrylic divider screen with courtesy shelf option available for this table.</p> <p>There are two different leg styles available:</p> <div style="display: flex; justify-content: space-around; align-items: center;"> <div style="text-align: center;">  <p>Model "R" 2 1/2" Diameter & Stem Leg</p> </div> <div style="text-align: center;">  <p>Model "S" 2" Square & Stem Leg</p> </div> </div>	
	PD-CGB48-PN-R	Pencil Edge; Dia. & Stem Leg							\$ 8,588
	PD-CGB48-PN-S	Pencil Edge; Square & Stem Leg							\$ 8,588
	PD-CGB48-BN-R	Bullnose Edge; Dia. & Stem Leg							\$ 8,750
	PD-CGB48-BN-S	Bullnose Edge; Square & Stem Leg							\$ 8,750
	PD-CGB48-SQ-R	Square Edge; Dia. & Stem Leg							\$ 8,669
PD-CGB48-SQ-S	Square Edge; Square & Stem Leg						\$ 8,669		
	8 PERSON UNIT: 60" Depth;	144"	60"	29"	_____ Lbs.	_____ Cu Ft		<p>There is an option for a Grommet and Wire Management leg for this table. In addition to the above, there is also a 1/2" thick frosted acrylic divider screen with courtesy shelf option available for this table.</p> <p>There are two different leg styles available:</p> <div style="display: flex; justify-content: space-around; align-items: center;"> <div style="text-align: center;">  <p>Model "R" 2 1/2" Diameter & Stem Leg</p> </div> <div style="text-align: center;">  <p>Model "S" 2" Square & Stem Leg</p> </div> </div>	
	PD-CGB60-PN-R	Pencil Edge; Dia. & Stem Leg							\$ 10,969
	PD-CGB60-PN-S	Pencil Edge; Square & Stem Leg							\$ 10,969
	PD-CGB60-BN-R	Bullnose Edge; Dia. & Stem Leg							\$ 11,169
	PD-CGB60-BN-S	Bullnose Edge; Square & Stem Leg							\$ 11,169
	PD-CGB60-SQ-R	Square Edge; Dia. & Stem Leg							\$ 11,069
PD-CGB60-SQ-S	Square Edge; Square & Stem Leg						\$ 11,069		
	8 PERSON UNIT: 48" Depth;	132"	48"	29"	_____ Lbs.	_____ Cu Ft		<p>There is an option for a Grommet and Wire Management leg for this table. In addition to the above, there is also a 1/2" thick frosted acrylic divider screen with courtesy shelf option available for this table.</p> <p>There are two different leg styles available:</p> <div style="display: flex; justify-content: space-around; align-items: center;"> <div style="text-align: center;">  <p>Model "R" 2 1/2" Diameter & Stem Leg</p> </div> <div style="text-align: center;">  <p>Model "S" 2" Square & Stem Leg</p> </div> </div>	
	8 Grommets;								
	4 Wire Management Legs;								
	PD-CGB48-PN-R-GW	Pencil Edge; Dia. & Stem Leg							\$ 9,488
	PD-CGB48-PN-S-GW	Pencil Edge; Square & Stem Leg							\$ 9,488
	PD-CGB48-BN-R-GW	Bullnose Edge; Dia. & Stem Leg							\$ 9,650
PD-CGB48-BN-S-GW	Bullnose Edge; Square & Stem Leg						\$ 9,650		
PD-CGB48-SQ-R-GW	Square Edge; Dia. & Stem Leg						\$ 9,569		
PD-CGB48-SQ-S-GW	Square Edge; Square & Stem Leg						\$ 9,569		
	8 PERSON UNIT: 60" Depth;	144"	60"	29"	_____ Lbs.	_____ Cu Ft		<p>There is an option for a Grommet and Wire Management leg for this table. In addition to the above, there is also a 1/2" thick frosted acrylic divider screen with courtesy shelf option available for this table.</p> <p>There are two different leg styles available:</p> <div style="display: flex; justify-content: space-around; align-items: center;"> <div style="text-align: center;">  <p>Model "R" 2 1/2" Diameter & Stem Leg</p> </div> <div style="text-align: center;">  <p>Model "S" 2" Square & Stem Leg</p> </div> </div>	
	8 Grommets;								
	4 Wire Management Legs;								
	PD-CGB60-PN-R-GW	Pencil Edge; Dia. & Stem Leg							\$ 11,869
	PD-CGB60-PN-S-GW	Pencil Edge; Square & Stem Leg							\$ 11,869
	PD-CGB60-BN-R-GW	Bullnose Edge; Dia. & Stem Leg							\$ 12,069
PD-CGB60-BN-S-GW	Bullnose Edge; Square & Stem Leg						\$ 12,069		
PD-CGB60-SQ-R-GW	Square Edge; Dia. & Stem Leg						\$ 11,969		
PD-CGB60-SQ-S-GW	Square Edge; Square & Stem Leg						\$ 11,969		

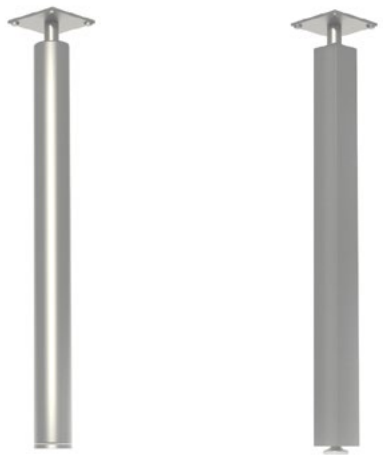















MODEL NUMBER	PRODUCT	WIDTH	DEPTH	HEIGHT	WEIGHT	VOLUME	LIST PRICE	DESCRIPTION
	8 PERSON UNIT: 48" Depth; 8 Grommets; 4 Wire Management Legs; Acrylic Dividers with top Shelf;	132"	48"	29"	_____ Lbs.	_____ Cu Ft		Each unit is a single user unit which can be combined together to create two and four user stations. There are three solid wood edge profiles available:
PD-CGB48-PN-R-GWA	Pencil Edge; Dia. & Stem Leg						\$ 11,100	 Model "PN" Model "BN" Model "SQ" 2" Pencil Edge 1 1/4" Bullnose Edge 3/4" Square Edge
PD-CGB48-PN-S-GWA	Pencil Edge; Square & Stem Leg					\$ 11,100		
PD-CGB48-BN-R-GWA	Bullnose Edge; Dia. & Stem Leg					\$ 11,263		
PD-CGB48-BN-S-GWA	Bullnose Edge; Square & Stem Leg					\$ 11,263		
PD-CGB48-SO-R-GWA	Square Edge; Dia. & Stem Leg					\$ 11,181		
PD-CGB48-SO-S-GWA	Square Edge; Square & Stem Leg					\$ 11,181		
	8 PERSON UNIT: 60" Depth; 8 Grommets; 4 Wire Management Legs; Acrylic Dividers with top Shelf;	144"	60"	29"	_____ Lbs.	_____ Cu Ft		There is an option for a Grommet and Wire Management leg for this table. In addition to the above, there is also a 1/2" thick frosted acrylic divider screen with courtesy shelf option available for this table.
PD-CGB60-PN-R-GWA	Pencil Edge; Dia. & Stem Leg						\$ 13,481	There are two different leg styles available:  Model "R" Model "S" 2 1/2" Diameter 2" Square & Stem Leg & Stem Leg
PD-CGB60-PN-S-GWA	Pencil Edge; Square & Stem Leg					\$ 13,481		
PD-CGB60-BN-R-GWA	Bullnose Edge; Dia. & Stem Leg					\$ 13,681		
PD-CGB60-BN-S-GWA	Bullnose Edge; Square & Stem Leg					\$ 13,681		
PD-CGB60-SO-R-GWA	Square Edge; Dia. & Stem Leg					\$ 13,581		
PD-CGB60-SO-S-GWA	Square Edge; Square & Stem Leg					\$ 13,581		











MODEL NUMBER	PRODUCT	WIDTH	DEPTH	HEIGHT	WEIGHT	VOLUME	LIST PRICE	DESCRIPTION	
	10 PERSON UNIT: 48" Depth;	168"	48"	29"	_____ Lbs.	_____ Cu Ft		<p>Each unit is a single user unit which can be combined together to create two and four user stations.</p> <p>There are three solid wood edge profiles available:</p> <div style="display: flex; justify-content: space-around; align-items: center;"> <div style="text-align: center;">  <p>Model "PN" 2" Pencil Edge</p> </div> <div style="text-align: center;">  <p>Model "BN" 1 1/4" Bullnose Edge</p> </div> <div style="text-align: center;">  <p>Model "SQ" 3/4" Square Edge</p> </div> </div> <p>There is an option for a Grommet and Wire Management leg for this table. In addition to the above, there is also a 1/2" thick frosted acrylic divider screen with courtesy shelf option available for this table.</p> <p>There are two different leg styles available:</p> <div style="display: flex; justify-content: space-around; align-items: center;"> <div style="text-align: center;">  <p>Model "R" 2 1/2" Diameter & Stem Leg</p> </div> <div style="text-align: center;">  <p>Model "S" 2" Square & Stem Leg</p> </div> </div>	
	PD-CGC48-PN-R	Pencil Edge; Dia. & Stem Leg							\$ 12,169
	PD-CGC48-PN-S	Pencil Edge; Square & Stem Leg							\$ 12,169
	PD-CGC48-BN-R	Bullnose Edge; Dia. & Stem Leg							\$ 12,350
	PD-CGC48-BN-S	Bullnose Edge; Square & Stem Leg							\$ 12,350
	PD-CGC48-SQ-R	Square Edge; Dia. & Stem Leg							\$ 12,256
PD-CGC48-SQ-S	Square Edge; Square & Stem Leg						\$ 12,256		
	10 PERSON UNIT: 60" Depth;	180"	60"	29"	_____ Lbs.	_____ Cu Ft		<p>There is an option for a Grommet and Wire Management leg for this table. In addition to the above, there is also a 1/2" thick frosted acrylic divider screen with courtesy shelf option available for this table.</p> <p>There are two different leg styles available:</p> <div style="display: flex; justify-content: space-around; align-items: center;"> <div style="text-align: center;">  <p>Model "R" 2 1/2" Diameter & Stem Leg</p> </div> <div style="text-align: center;">  <p>Model "S" 2" Square & Stem Leg</p> </div> </div>	
	PD-CGC60-PN-R	Pencil Edge; Dia. & Stem Leg							\$ 13,519
	PD-CGC60-PN-S	Pencil Edge; Square & Stem Leg							\$ 13,519
	PD-CGC60-BN-R	Bullnose Edge; Dia. & Stem Leg							\$ 13,738
	PD-CGC60-BN-S	Bullnose Edge; Square & Stem Leg							\$ 13,738
	PD-CGC60-SQ-R	Square Edge; Dia. & Stem Leg							\$ 13,631
PD-CGC60-SQ-S	Square Edge; Square & Stem Leg						\$ 13,631		
	10 PERSON UNIT: 48" Depth;	168"	48"	29"	_____ Lbs.	_____ Cu Ft		<p>There is an option for a Grommet and Wire Management leg for this table. In addition to the above, there is also a 1/2" thick frosted acrylic divider screen with courtesy shelf option available for this table.</p> <p>There are two different leg styles available:</p> <div style="display: flex; justify-content: space-around; align-items: center;"> <div style="text-align: center;">  <p>Model "R" 2 1/2" Diameter & Stem Leg</p> </div> <div style="text-align: center;">  <p>Model "S" 2" Square & Stem Leg</p> </div> </div>	
	10 Grommets;								
	6 Wire Management Legs;								
	PD-CGC48-PN-R-GW	Pencil Edge; Dia. & Stem Leg							\$ 13,306
	PD-CGC48-PN-S-GW	Pencil Edge; Square & Stem Leg							\$ 13,306
	PD-CGC48-BN-R-GW	Bullnose Edge; Dia. & Stem Leg							\$ 13,488
PD-CGC48-BN-S-GW	Bullnose Edge; Square & Stem Leg						\$ 13,488		
PD-CGC48-SQ-R-GW	Square Edge; Dia. & Stem Leg						\$ 13,394		
PD-CGC48-SQ-S-GW	Square Edge; Square & Stem Leg						\$ 13,394		
	10 PERSON UNIT: 60" Depth;	180"	60"	29"	_____ Lbs.	_____ Cu Ft		<p>There is an option for a Grommet and Wire Management leg for this table. In addition to the above, there is also a 1/2" thick frosted acrylic divider screen with courtesy shelf option available for this table.</p> <p>There are two different leg styles available:</p> <div style="display: flex; justify-content: space-around; align-items: center;"> <div style="text-align: center;">  <p>Model "R" 2 1/2" Diameter & Stem Leg</p> </div> <div style="text-align: center;">  <p>Model "S" 2" Square & Stem Leg</p> </div> </div>	
	10 Grommets;								
	6 Wire Management Legs;								
	PD-CGC60-PN-R-GW	Pencil Edge; Dia. & Stem Leg							\$ 14,656
	PD-CGC60-PN-S-GW	Pencil Edge; Square & Stem Leg							\$ 14,656
	PD-CGC60-BN-R-GW	Bullnose Edge; Dia. & Stem Leg							\$ 14,875
PD-CGC60-BN-S-GW	Bullnose Edge; Square & Stem Leg						\$ 14,875		
PD-CGC60-SQ-R-GW	Square Edge; Dia. & Stem Leg						\$ 14,769		
PD-CGC60-SQ-S-GW	Square Edge; Square & Stem Leg						\$ 14,769		

















MODEL NUMBER	PRODUCT	WIDTH	DEPTH	HEIGHT	WEIGHT	VOLUME	LIST PRICE	DESCRIPTION
	10 PERSON UNIT: 48" Depth; 10 Grommets; 6 Wire Management Legs; Acrylic Dividers with top Shelf;	168"	48"	29"	_____ Lbs.	_____ Cu Ft		Each unit is a single user unit which can be combined together to create two and four user stations. There are three solid wood edge profiles available:
PD-CGC48-PN-R-GWA	Pencil Edge; Dia. & Stem Leg						\$ 15,325	 <p>Model "PN" Model "BN" Model "SQ"</p> <p>2" Pencil Edge 1 1/4" Bullnose Edge 3/4" Square Edge</p>
PD-CGC48-PN-S-GWA	Pencil Edge; Square & Stem Leg					\$ 15,325		
PD-CGC48-BN-R-GWA	Bullnose Edge; Dia. & Stem Leg					\$ 15,513		
PD-CGC48-BN-S-GWA	Bullnose Edge; Square & Stem Leg					\$ 15,513		
PD-CGC48-SO-R-GWA	Square Edge; Dia. & Stem Leg					\$ 15,419		
PD-CGC48-SO-S-GWA	Square Edge; Square & Stem Leg					\$ 15,419		
	10 PERSON UNIT: 60" Depth; 10 Grommets; 6 Wire Management Legs; Acrylic Dividers with top Shelf;	180"	60"	29"	_____ Lbs.	_____ Cu Ft		There is an option for a Grommet and Wire Management leg for this table. In addition to the above, there is also a 1/2" thick frosted acrylic divider screen with courtesy shelf option available for this table.
PD-CGC60-PN-R-GWA	Pencil Edge; Dia. & Stem Leg						\$ 16,681	<p>There are two different leg styles available:</p>  <p>Model "R" Model "S"</p> <p>2 1/2" Diameter 2" Square</p> <p>& Stem Leg & Stem Leg</p>
PD-CGC60-PN-S-GWA	Pencil Edge; Square & Stem Leg					\$ 16,681		
PD-CGC60-BN-R-GWA	Bullnose Edge; Dia. & Stem Leg					\$ 16,900		
PD-CGC60-BN-S-GWA	Bullnose Edge; Square & Stem Leg					\$ 16,900		
PD-CGC60-SO-R-GWA	Square Edge; Dia. & Stem Leg					\$ 16,788		
PD-CGC60-SO-S-GWA	Square Edge; Square & Stem Leg					\$ 16,788		







MODEL NUMBER	PRODUCT	WIDTH	DEPTH	HEIGHT	WEIGHT	VOLUME	LIST PRICE	DESCRIPTION
	ROUND Tables:							Each table is constructed of a 1" thick top with a plastic laminate top surface.
	36" Diameter;	36" Diameter		29"	__ Lbs.	__ Cu Ft		There are three edge profiles available:
SO-R36-AC-ST	Acrylic Edge; Straight Leg						\$ 869	   Model "AC" Acrylic Edge Model "BN" 3/4" Bullnose Edge Model "SQ" 1/4" Square Edge
SO-R36-AC-WC	Acrylic Edge; Wave Caster Leg						\$ 1,244	
SO-R36-AC-WF	Acrylic Edge; Wave Fixed Leg						\$ 931	
SO-R36-BN-ST	Bullnose Edge; Straight Leg						\$ 1,063	
SO-R36-BN-WC	Bullnose Edge; Wave Caster Leg						\$ 1,431	
SO-R36-BN-WF	Bullnose Edge; Wave Fixed Leg						\$ 1,119	
SO-R36-SQ-ST	Square Edge; Straight Leg						\$ 994	
SO-R36-SQ-WC	Square Edge; Wave Caster Leg						\$ 1,363	
SO-R36-SQ-WF	Square Edge; Wave Fixed Leg						\$ 1,050	
	42" Diameter;	42" Diameter		29"	__ Lbs.	__ Cu Ft		There are three different leg styles available:
SO-R42-AC-ST	Acrylic Edge; Straight Leg						\$ 925	   Model "ST" Straight 1 1/2" Diameter Leg Model "WF" Wave Fixed Leg Model "WC" Wave Caster Leg
SO-R42-AC-WC	Acrylic Edge; Wave Caster Leg						\$ 1,300	
SO-R42-AC-WF	Acrylic Edge; Wave Fixed Leg						\$ 988	
SO-R42-BN-ST	Bullnose Edge; Straight Leg						\$ 1,150	
SO-R42-BN-WC	Bullnose Edge; Wave Caster Leg						\$ 1,519	
SO-R42-BN-WF	Bullnose Edge; Wave Fixed Leg						\$ 1,206	
SO-R42-SQ-ST	Square Edge; Straight Leg						\$ 1,069	
SO-R42-SQ-WC	Square Edge; Wave Caster Leg						\$ 1,444	
SO-R42-SQ-WF	Square Edge; Wave Fixed Leg						\$ 1,125	
	48" Diameter;	48" Diameter		29"	__ Lbs.	__ Cu Ft		
SO-R48-AC-ST	Acrylic Edge; Straight Leg						\$ 994	
SO-R48-AC-WC	Acrylic Edge; Wave Caster Leg						\$ 1,369	
SO-R48-AC-WF	Acrylic Edge; Wave Fixed Leg						\$ 1,050	
SO-R48-BN-ST	Bullnose Edge; Straight Leg						\$ 1,244	
SO-R48-BN-WC	Bullnose Edge; Wave Caster Leg						\$ 1,619	
SO-R48-BN-WF	Bullnose Edge; Wave Fixed Leg						\$ 1,306	
SO-R48-SQ-ST	Square Edge; Straight Leg						\$ 1,156	
SO-R48-SQ-WC	Square Edge; Wave Caster Leg						\$ 1,525	
SO-R48-SQ-WF	Square Edge; Wave Fixed Leg						\$ 1,213	



MODEL NUMBER	PRODUCT	WIDTH	DEPTH	HEIGHT	WEIGHT	VOLUME	LIST PRICE	DESCRIPTION
	ROUND Tables:							Each table is constructed of a 1" thick top with a plastic laminate top surface.
	54" Diameter;	54" Diameter		29"	__ Lbs.	__ Cu Ft		There are three edge profiles available:
SO-R54-AC-ST	Acrylic Edge; Straight Leg						\$ 1,056	  
SO-R54-AC-WC	Acrylic Edge; Wave Caster Leg						\$ 1,425	
SO-R54-AC-WF	Acrylic Edge; Wave Fixed Leg						\$ 1,113	
SO-R54-BN-ST	Bullnose Edge; Straight Leg						\$ 1,375	  
SO-R54-BN-WC	Bullnose Edge; Wave Caster Leg						\$ 1,713	
SO-R54-BN-WF	Bullnose Edge; Wave Fixed Leg						\$ 1,400	
SO-R54-SQ-ST	Square Edge; Straight Leg						\$ 1,238	There are three different leg styles available:
SO-R54-SQ-WC	Square Edge; Wave Caster Leg						\$ 1,613	
SO-R54-SQ-WF	Square Edge; Wave Fixed Leg						\$ 1,294	
	60" Diameter;	60" Diameter		29"	__ Lbs.	__ Cu Ft		
SO-R60-AC-ST	Acrylic Edge; Straight Leg						\$ 1,138	  
SO-R60-AC-WC	Acrylic Edge; Wave Caster Leg						\$ 1,506	
SO-R60-AC-WF	Acrylic Edge; Wave Fixed Leg						\$ 1,194	
SO-R60-BN-ST	Bullnose Edge; Straight Leg						\$ 1,450	  
SO-R60-BN-WC	Bullnose Edge; Wave Caster Leg						\$ 1,819	
SO-R60-BN-WF	Bullnose Edge; Wave Fixed Leg						\$ 1,844	
SO-R60-SQ-ST	Square Edge; Straight Leg						\$ 1,338	  
SO-R60-SQ-WC	Square Edge; Wave Caster Leg						\$ 1,713	
SO-R60-SQ-WF	Square Edge; Wave Fixed Leg						\$ 1,394	

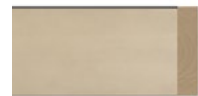





MODEL NUMBER	PRODUCT	WIDTH	DEPTH	HEIGHT	WEIGHT	VOLUME	LIST PRICE	DESCRIPTION
	HALF ROUND Tables:							Each table is constructed of a 1" thick top with a plastic laminate top surface.
	48" Width;	48"	24"	29"	__ Lbs.	__ Cu Ft		There are three edge profiles available:
SO-HR-4824-AC-ST	Acrylic Edge; Straight Leg						\$ 838	
SO-HR-4824-AC-WC	Acrylic Edge; Wave Caster Leg						\$ 1,213	
SO-HR-4824-AC-WF	Acrylic Edge; Wave Fixed Leg						\$ 900	
SO-HR-4824-BN-ST	Bullnose Edge; Straight Leg						\$ 975	
SO-HR-4824-BN-WC	Bullnose Edge; Wave Caster Leg						\$ 1,344	
SO-HR-4824-BN-WF	Bullnose Edge; Wave Fixed Leg						\$ 1,031	
SO-HR-4824-SQ-ST	Square Edge; Straight Leg						\$ 925	
SO-HR-4824-SQ-WC	Square Edge; Wave Caster Leg						\$ 1,300	
SO-HR-4824-SQ-WF	Square Edge; Wave Fixed Leg						\$ 981	
	54" Width;	54"	27"	29"	__ Lbs.	__ Cu Ft		
SO-HR-5427-AC-ST	Acrylic Edge; Straight Leg						\$ 875	
SO-HR-5427-AC-WC	Acrylic Edge; Wave Caster Leg						\$ 1,250	
SO-HR-5427-AC-WF	Acrylic Edge; Wave Fixed Leg						\$ 938	
SO-HR-5427-BN-ST	Bullnose Edge; Straight Leg						\$ 1,025	
SO-HR-5427-BN-WC	Bullnose Edge; Wave Caster Leg						\$ 1,394	
SO-HR-5427-BN-WF	Bullnose Edge; Wave Fixed Leg						\$ 1,081	
SO-HR-5427-SQ-ST	Square Edge; Straight Leg						\$ 975	
SO-HR-5427-SQ-WC	Square Edge; Wave Caster Leg						\$ 1,344	
SO-HR-5427-SQ-WF	Square Edge; Wave Fixed Leg						\$ 1,031	
	60" Width;	60"	30"	29"	__ Lbs.	__ Cu Ft		
SO-HR-6030-AC-ST	Acrylic Edge; Straight Leg						\$ 913	
SO-HR-6030-AC-WC	Acrylic Edge; Wave Caster Leg						\$ 1,288	
SO-HR-6030-AC-WF	Acrylic Edge; Wave Fixed Leg						\$ 975	
SO-HR-6030-BN-ST	Bullnose Edge; Straight Leg						\$ 1,081	
SO-HR-6030-BN-WC	Bullnose Edge; Wave Caster Leg						\$ 1,456	
SO-HR-6030-BN-WF	Bullnose Edge; Wave Fixed Leg						\$ 1,138	
SO-HR-6030-SQ-ST	Square Edge; Straight Leg						\$ 1,025	
SO-HR-6030-SQ-WC	Square Edge; Wave Caster Leg						\$ 1,394	
SO-HR-6030-SQ-WF	Square Edge; Wave Fixed Leg						\$ 1,081	







MODEL NUMBER	PRODUCT	WIDTH	DEPTH	HEIGHT	WEIGHT	VOLUME	LIST PRICE	DESCRIPTION
	QUARTER ROUND Tables:							Each table is constructed of a 1" thick top with a plastic laminate top surface.
	24" Width;	24"	24"	29"	__ Lbs.	__ Cu Ft		There are three edge profiles available:
SO-QR-24-AC-ST	Acrylic Edge; Straight Leg						\$ 719	  
SO-QR-24-AC-WC	Acrylic Edge; Wave Caster Leg						\$ 994	
SO-QR-24-AC-WF	Acrylic Edge; Wave Fixed Leg						\$ 763	
SO-QR-24-BN-ST	Bullnose Edge; Straight Leg						\$ 863	  
SO-QR-24-BN-WC	Bullnose Edge; Wave Caster Leg						\$ 1,138	
SO-QR-24-BN-WF	Bullnose Edge; Wave Fixed Leg						\$ 900	
SO-QR-24-SQ-ST	Square Edge; Straight Leg						\$ 813	<p>There are three different leg styles available:</p>
SO-QR-24-SQ-WC	Square Edge; Wave Caster Leg						\$ 1,088	
SO-QR-24-SQ-WF	Square Edge; Wave Fixed Leg						\$ 850	
	30" Width;	30"	30"	29"	__ Lbs.	__ Cu Ft		
SO-QR-30-AC-ST	Acrylic Edge; Straight Leg						\$ 756	
SO-QR-30-AC-WC	Acrylic Edge; Wave Caster Leg						\$ 1,038	
SO-QR-30-AC-WF	Acrylic Edge; Wave Fixed Leg						\$ 800	
SO-QR-30-BN-ST	Bullnose Edge; Straight Leg						\$ 938	
SO-QR-30-BN-WC	Bullnose Edge; Wave Caster Leg						\$ 1,213	
SO-QR-30-BN-WF	Bullnose Edge; Wave Fixed Leg						\$ 981	
SO-QR-30-SQ-ST	Square Edge; Straight Leg						\$ 875	
SO-QR-30-SQ-WC	Square Edge; Wave Caster Leg						\$ 1,150	
SO-QR-30-SQ-WF	Square Edge; Wave Fixed Leg						\$ 919	

MODEL NUMBER	PRODUCT	WIDTH	DEPTH	HEIGHT	WEIGHT	VOLUME	LIST PRICE	DESCRIPTION
	SQUARE Tables:							Each table is constructed of a 1" thick top with a plastic laminate top surface.
	24" Width;	24"	24"	29"	__ Lbs.	__ Cu Ft		There are three edge profiles available:
SO-2424-AC-ST	Acrylic Edge; Straight Leg						\$ 775	
SO-2424-AC-WC	Acrylic Edge; Wave Caster Leg						\$ 1,150	
SO-2424-AC-WF	Acrylic Edge; Wave Fixed Leg						\$ 831	
SO-2424-BN-ST	Bullnose Edge; Straight Leg						\$ 938	
SO-2424-BN-WC	Bullnose Edge; Wave Caster Leg						\$ 1,306	
SO-2424-BN-WF	Bullnose Edge; Wave Fixed Leg						\$ 994	
SO-2424-SQ-ST	Square Edge; Straight Leg						\$ 881	
SO-2424-SQ-WC	Square Edge; Wave Caster Leg						\$ 1,250	
SO-2424-SQ-WF	Square Edge; Wave Fixed Leg						\$ 938	
	30" Width;	30"	30"	29"	__ Lbs.	__ Cu Ft		
SO-3030-AC-ST	Acrylic Edge; Straight Leg						\$ 819	
SO-3030-AC-WC	Acrylic Edge; Wave Caster Leg						\$ 1,188	
SO-3030-AC-WF	Acrylic Edge; Wave Fixed Leg						\$ 875	
SO-3030-BN-ST	Bullnose Edge; Straight Leg						\$ 1,019	
SO-3030-BN-WC	Bullnose Edge; Wave Caster Leg						\$ 1,388	
SO-3030-BN-WF	Bullnose Edge; Wave Fixed Leg						\$ 1,075	
SO-3030-SQ-ST	Square Edge; Straight Leg						\$ 944	
SO-3030-SQ-WC	Square Edge; Wave Caster Leg						\$ 1,319	
SO-3030-SQ-WF	Square Edge; Wave Fixed Leg						\$ 1,000	

MODEL NUMBER	PRODUCT	WIDTH	DEPTH	HEIGHT	WEIGHT	VOLUME	LIST PRICE	DESCRIPTION
RECTANGLE Tables, 24" Depth:								
	30" Width;	30"	24"	29"	___ Lbs.	___ Cu Ft		Each table is constructed of a 1" thick top with a plastic laminate top surface.
SO-3024-AC-ST	Acrylic Edge; Straight Leg						\$ 794	<p>There are three edge profiles available:</p>    <p>Model "AC" Acrylic Edge Model "BN" 3/4" Bullnose Edge Model "SO" 1/4" Square Edge</p> <p>There are three different leg styles available:</p>    <p>Model "ST" Straight 1 1/2" Diameter Leg Model "WF" Wave Fixed Leg Model "WC" Wave Caster Leg</p>
SO-3024-AC-WC	Acrylic Edge; Wave Caster Leg						\$ 1,163	
SO-3024-AC-WF	Acrylic Edge; Wave Fixed Leg						\$ 850	
SO-3024-BN-ST	Bullnose Edge; Straight Leg						\$ 975	
SO-3024-BN-WC	Bullnose Edge; Wave Caster Leg						\$ 1,344	
SO-3024-BN-WF	Bullnose Edge; Wave Fixed Leg						\$ 1,031	
SO-3024-SQ-ST	Square Edge; Straight Leg						\$ 913	
SO-3024-SQ-WC	Square Edge; Wave Caster Leg						\$ 1,281	
SO-3024-SQ-WF	Square Edge; Wave Fixed Leg						\$ 969	
	36" Width;	36"	24"	29"	___ Lbs.	___ Cu Ft		
SO-3624-AC-ST	Acrylic Edge; Straight Leg						\$ 813	
SO-3624-AC-WC	Acrylic Edge; Wave Caster Leg						\$ 1,181	
SO-3624-AC-WF	Acrylic Edge; Wave Fixed Leg						\$ 869	
SO-3624-BN-ST	Bullnose Edge; Straight Leg						\$ 1,013	
SO-3624-BN-WC	Bullnose Edge; Wave Caster Leg						\$ 1,381	
SO-3624-BN-WF	Bullnose Edge; Wave Fixed Leg						\$ 1,069	
SO-3624-SQ-ST	Square Edge; Straight Leg						\$ 944	
SO-3624-SQ-WC	Square Edge; Wave Caster Leg						\$ 1,313	
SO-3624-SQ-WF	Square Edge; Wave Fixed Leg						\$ 1,000	
	42" Width;	42"	24"	29"	___ Lbs.	___ Cu Ft		
SO-4224-AC-ST	Acrylic Edge; Straight Leg						\$ 831	
SO-4224-AC-WC	Acrylic Edge; Wave Caster Leg						\$ 1,200	
SO-4224-AC-WF	Acrylic Edge; Wave Fixed Leg						\$ 888	
SO-4224-BN-ST	Bullnose Edge; Straight Leg						\$ 1,050	
SO-4224-BN-WC	Bullnose Edge; Wave Caster Leg						\$ 1,419	
SO-4224-BN-WF	Bullnose Edge; Wave Fixed Leg						\$ 1,106	
SO-4224-SQ-ST	Square Edge; Straight Leg						\$ 975	
SO-4224-SQ-WC	Square Edge; Wave Caster Leg						\$ 1,344	
SO-4224-SQ-WF	Square Edge; Wave Fixed Leg						\$ 1,031	
	48" Width;	48"	24"	29"	___ Lbs.	___ Cu Ft		
SO-4824-AC-ST	Acrylic Edge; Straight Leg						\$ 850	
SO-4824-AC-WC	Acrylic Edge; Wave Caster Leg						\$ 1,219	
SO-4824-AC-WF	Acrylic Edge; Wave Fixed Leg						\$ 906	
SO-4824-BN-ST	Bullnose Edge; Straight Leg						\$ 1,088	
SO-4824-BN-WC	Bullnose Edge; Wave Caster Leg						\$ 1,456	
SO-4824-BN-WF	Bullnose Edge; Wave Fixed Leg						\$ 1,144	
SO-4824-SQ-ST	Square Edge; Straight Leg						\$ 1,006	
SO-4824-SQ-WC	Square Edge; Wave Caster Leg						\$ 1,375	
SO-4824-SQ-WF	Square Edge; Wave Fixed Leg						\$ 1,063	

MODEL NUMBER	PRODUCT	WIDTH	DEPTH	HEIGHT	WEIGHT	VOLUME	LIST PRICE	DESCRIPTION	
RECTANGLE Tables, 24" Depth:									
	54" Width;	54"	24"	29"	___ Lbs.	___ Cu Ft		Each table is constructed of a 1" thick top with a plastic laminate top surface.	
SO-5424-AC-ST	Acrylic Edge; Straight Leg						\$ 869	<p>There are three edge profiles available:</p>  <p>Model "AC" Acrylic Edge Model "BN" 3/4" Bullnose Edge Model "SQ" 1/4" Square Edge</p> <p>There are three different leg styles available:</p>  <p>Model "ST" Straight 1 1/2" Diameter Leg Model "WF" Wave Fixed Leg Model "WC" Wave Caster Leg</p>	
SO-5424-AC-WC	Acrylic Edge; Wave Caster Leg						\$ 1,238		
SO-5424-AC-WF	Acrylic Edge; Wave Fixed Leg						\$ 925		
SO-5424-BN-ST	Bullnose Edge; Straight Leg						\$ 1,125		
SO-5424-BN-WC	Bullnose Edge; Wave Caster Leg						\$ 1,500		
SO-5424-BN-WF	Bullnose Edge; Wave Fixed Leg						\$ 1,181		
SO-5424-SQ-ST	Square Edge; Straight Leg						\$ 1,031		
SO-5424-SQ-WC	Square Edge; Wave Caster Leg						\$ 1,406		
SO-5424-SQ-WF	Square Edge; Wave Fixed Leg						\$ 1,094		
	60" Width;	60"	24"	29"	___ Lbs.	___ Cu Ft			
SO-6024-AC-ST	Acrylic Edge; Straight Leg						\$ 888		
SO-6024-AC-WC	Acrylic Edge; Wave Caster Leg						\$ 1,256		
SO-6024-AC-WF	Acrylic Edge; Wave Fixed Leg						\$ 944		
SO-6024-BN-ST	Bullnose Edge; Straight Leg						\$ 1,163		
SO-6024-BN-WC	Bullnose Edge; Wave Caster Leg						\$ 1,538		
SO-6024-BN-WF	Bullnose Edge; Wave Fixed Leg						\$ 1,219		
SO-6024-SQ-ST	Square Edge; Straight Leg						\$ 1,063		
SO-6024-SQ-WC	Square Edge; Wave Caster Leg						\$ 1,438		
SO-6024-SQ-WF	Square Edge; Wave Fixed Leg						\$ 1,125		
	72" Width;	72"	24"	29"	___ Lbs.	___ Cu Ft			
SO-7224-AC-ST	Acrylic Edge; Straight Leg						\$ 919		
SO-7224-AC-WC	Acrylic Edge; Wave Caster Leg						\$ 1,294		
SO-7224-AC-WF	Acrylic Edge; Wave Fixed Leg						\$ 981		
SO-7224-BN-ST	Bullnose Edge; Straight Leg						\$ 1,244		
SO-7224-BN-WC	Bullnose Edge; Wave Caster Leg						\$ 1,613		
SO-7224-BN-WF	Bullnose Edge; Wave Fixed Leg						\$ 1,300		
SO-7224-SQ-ST	Square Edge; Straight Leg						\$ 1,125		
SO-7224-SQ-WC	Square Edge; Wave Caster Leg						\$ 1,500		
SO-7224-SQ-WF	Square Edge; Wave Fixed Leg						\$ 1,181		

MODEL NUMBER	PRODUCT	WIDTH	DEPTH	HEIGHT	WEIGHT	VOLUME	LIST PRICE	DESCRIPTION
	RECTANGLE Tables, 30" Depth:							Each table is constructed of a 1" thick top with a plastic laminate top surface.
	36" Width;	36"	30"	29"	__ Lbs.	__ Cu Ft		There are three edge profiles available:
SO-3630-AC-ST	Acrylic Edge; Straight Leg						\$ 838	
SO-3630-AC-WC	Acrylic Edge; Wave Caster Leg						\$ 1,213	
SO-3630-AC-WF	Acrylic Edge; Wave Fixed Leg						\$ 894	
SO-3630-BN-ST	Bullnose Edge; Straight Leg						\$ 1,056	
SO-3630-BN-WC	Bullnose Edge; Wave Caster Leg						\$ 1,431	
SO-3630-BN-WF	Bullnose Edge; Wave Fixed Leg						\$ 1,119	
SO-3630-SQ-ST	Square Edge; Straight Leg						\$ 981	
SO-3630-SQ-WC	Square Edge; Wave Caster Leg						\$ 1,350	
SO-3630-SQ-WF	Square Edge; Wave Fixed Leg						\$ 1,038	
	42" Width;	42"	30"	29"	__ Lbs.	__ Cu Ft		There are three different leg styles available:
SO-4230-AC-ST	Acrylic Edge; Straight Leg						\$ 863	
SO-4230-AC-WC	Acrylic Edge; Wave Caster Leg						\$ 1,231	
SO-4230-AC-WF	Acrylic Edge; Wave Fixed Leg						\$ 919	
SO-4230-BN-ST	Bullnose Edge; Straight Leg						\$ 1,100	
SO-4230-BN-WC	Bullnose Edge; Wave Caster Leg						\$ 1,469	
SO-4230-BN-WF	Bullnose Edge; Wave Fixed Leg						\$ 1,156	
SO-4230-SQ-ST	Square Edge; Straight Leg						\$ 1,019	
SO-4230-SQ-WC	Square Edge; Wave Caster Leg						\$ 1,388	
SO-4230-SQ-WF	Square Edge; Wave Fixed Leg						\$ 1,075	
	48" Width;	48"	30"	29"	__ Lbs.	__ Cu Ft		
SO-4830-AC-ST	Acrylic Edge; Straight Leg						\$ 881	
SO-4830-AC-WC	Acrylic Edge; Wave Caster Leg						\$ 1,256	
SO-4830-AC-WF	Acrylic Edge; Wave Fixed Leg						\$ 944	
SO-4830-BN-ST	Bullnose Edge; Straight Leg						\$ 1,144	
SO-4830-BN-WC	Bullnose Edge; Wave Caster Leg						\$ 1,513	
SO-4830-BN-WF	Bullnose Edge; Wave Fixed Leg						\$ 1,200	
SO-4830-SQ-ST	Square Edge; Straight Leg						\$ 1,050	
SO-4830-SQ-WC	Square Edge; Wave Caster Leg						\$ 1,419	
SO-4830-SQ-WF	Square Edge; Wave Fixed Leg						\$ 1,106	

MODEL NUMBER	PRODUCT	WIDTH	DEPTH	HEIGHT	WEIGHT	VOLUME	LIST PRICE	DESCRIPTION
	RECTANGLE Tables, 30" Depth:							Each table is constructed of a 1" thick top with a plastic laminate top surface.
	54" Width;	54"	30"	29"	__ Lbs.	__ Cu Ft		There are three edge profiles available:
SO-5430-AC-ST	Acrylic Edge; Straight Leg						\$ 906	
SO-5430-AC-WC	Acrylic Edge; Wave Caster Leg						\$ 1,275	
SO-5430-AC-WF	Acrylic Edge; Wave Fixed Leg						\$ 963	
SO-5430-BN-ST	Bullnose Edge; Straight Leg						\$ 1,188	
SO-5430-BN-WC	Bullnose Edge; Wave Caster Leg						\$ 1,556	
SO-5430-BN-WF	Bullnose Edge; Wave Fixed Leg						\$ 1,244	
SO-5430-SQ-ST	Square Edge; Straight Leg						\$ 1,088	
SO-5430-SQ-WC	Square Edge; Wave Caster Leg						\$ 1,456	
SO-5430-SQ-WF	Square Edge; Wave Fixed Leg						\$ 1,144	
	60" Width;	60"	30"	29"	__ Lbs.	__ Cu Ft		There are three different leg styles available:
SO-6030-AC-ST	Acrylic Edge; Straight Leg						\$ 931	
SO-6030-AC-WC	Acrylic Edge; Wave Caster Leg						\$ 1,300	
SO-6030-AC-WF	Acrylic Edge; Wave Fixed Leg						\$ 988	
SO-6030-BN-ST	Bullnose Edge; Straight Leg						\$ 1,225	
SO-6030-BN-WC	Bullnose Edge; Wave Caster Leg						\$ 1,600	
SO-6030-BN-WF	Bullnose Edge; Wave Fixed Leg						\$ 1,288	
SO-6030-SQ-ST	Square Edge; Straight Leg						\$ 1,119	
SO-6030-SQ-WC	Square Edge; Wave Caster Leg						\$ 1,494	
SO-6030-SQ-WF	Square Edge; Wave Fixed Leg						\$ 1,175	
	72" Width;	72"	30"	29"	__ Lbs.	__ Cu Ft		
SO-7230-AC-ST	Acrylic Edge; Straight Leg						\$ 975	
SO-7230-AC-WC	Acrylic Edge; Wave Caster Leg						\$ 1,344	
SO-7230-AC-WF	Acrylic Edge; Wave Fixed Leg						\$ 1,031	
SO-7230-BN-ST	Bullnose Edge; Straight Leg						\$ 1,313	
SO-7230-BN-WC	Bullnose Edge; Wave Caster Leg						\$ 1,681	
SO-7230-BN-WF	Bullnose Edge; Wave Fixed Leg						\$ 1,369	
SO-7230-SQ-ST	Square Edge; Straight Leg						\$ 1,194	
SO-7230-SQ-WC	Square Edge; Wave Caster Leg						\$ 1,563	
SO-7230-SQ-WF	Square Edge; Wave Fixed Leg						\$ 1,250	



Model "AC"
Acrylic Edge

Model "BN"
3/4" Bullnose Edge









Model "SQ"
1/4" Square Edge

















Model "ST"
Straight 1 1/2"
Diameter Leg





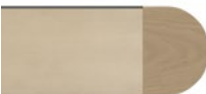

Model "WF"
Wave
Fixed Leg









Model "WC"
Wave
Caster Leg







MODEL NUMBER	PRODUCT	WIDTH	DEPTH	HEIGHT	WEIGHT	VOLUME	LIST PRICE	DESCRIPTION
	TRAPEZOIDAL Tables:							Each table is constructed of a 1" thick top with a plastic laminate top surface.
	48" Width;	48"	21"	29"	___ Lbs.	___ Cu Ft		There are three edge profiles available:
SO-TZ-4821-AC-ST	Acrylic Edge; Straight Leg						\$ 831	
SO-TZ-4821-AC-WC	Acrylic Edge; Wave Caster Leg						\$ 1,200	
SO-TZ-4821-AC-WF	Acrylic Edge; Wave Fixed Leg						\$ 888	
SO-TZ-4821-BN-ST	Bullnose Edge; Straight Leg						\$ 1,031	
SO-TZ-4821-BN-WC	Bullnose Edge; Wave Caster Leg						\$ 1,400	
SO-TZ-4821-BN-WF	Bullnose Edge; Wave Fixed Leg						\$ 1,088	
SO-TZ-4821-SQ-ST	Square Edge; Straight Leg						\$ 956	
SO-TZ-4821-SQ-WC	Square Edge; Wave Caster Leg						\$ 1,331	
SO-TZ-4821-SQ-WF	Square Edge; Wave Fixed Leg						\$ 1,013	
	54" Width;	54"	23"	29"	___ Lbs.	___ Cu Ft		There are three different leg styles available:
SO-TZ-5423-AC-ST	Acrylic Edge; Straight Leg						\$ 856	
SO-TZ-5423-AC-WC	Acrylic Edge; Wave Caster Leg						\$ 1,231	
SO-TZ-5423-AC-WF	Acrylic Edge; Wave Fixed Leg						\$ 919	
SO-TZ-5423-BN-ST	Bullnose Edge; Straight Leg						\$ 1,081	
SO-TZ-5423-BN-WC	Bullnose Edge; Wave Caster Leg						\$ 1,456	
SO-TZ-5423-BN-WF	Bullnose Edge; Wave Fixed Leg						\$ 1,138	
SO-TZ-5423-SQ-ST	Square Edge; Straight Leg						\$ 1,006	
SO-TZ-5423-SQ-WC	Square Edge; Wave Caster Leg						\$ 1,375	
SO-TZ-5423-SQ-WF	Square Edge; Wave Fixed Leg						\$ 1,063	
	60" Width;	60"	26"	29"	___ Lbs.	___ Cu Ft		
SO-TZ-6026-AC-ST	Acrylic Edge; Straight Leg						\$ 900	
SO-TZ-6026-AC-WC	Acrylic Edge; Wave Caster Leg						\$ 1,269	
SO-TZ-6026-AC-WF	Acrylic Edge; Wave Fixed Leg						\$ 956	
SO-TZ-6026-BN-ST	Bullnose Edge; Straight Leg						\$ 1,150	
SO-TZ-6026-BN-WC	Bullnose Edge; Wave Caster Leg						\$ 1,519	
SO-TZ-6026-BN-WF	Bullnose Edge; Wave Fixed Leg						\$ 1,206	
SO-TZ-6026-SQ-ST	Square Edge; Straight Leg						\$ 1,144	
SO-TZ-6026-SQ-WC	Square Edge; Wave Caster Leg						\$ 1,431	
SO-TZ-6026-SQ-WF	Square Edge; Wave Fixed Leg						\$ 1,113	
	BARREL Table:	72"	36"	29"	___ Lbs.	___ Cu Ft		
SO-BR-7236-AC-ST	Acrylic Edge; Straight Leg						\$ 1,025	
SO-BR-7236-AC-WC	Acrylic Edge; Wave Caster Leg						\$ 1,394	
SO-BR-7236-AC-WF	Acrylic Edge; Wave Fixed Leg						\$ 1,081	
SO-BR-7236-BN-ST	Bullnose Edge; Straight Leg						\$ 1,331	
SO-BR-7236-BN-WC	Bullnose Edge; Wave Caster Leg						\$ 1,700	
SO-BR-7236-BN-WF	Bullnose Edge; Wave Fixed Leg						\$ 1,388	
SO-BR-7236-SQ-ST	Square Edge; Straight Leg						\$ 1,219	
SO-BR-7236-SQ-WC	Square Edge; Wave Caster Leg						\$ 1,588	
SO-BR-7236-SQ-WF	Square Edge; Wave Fixed Leg						\$ 1,275	





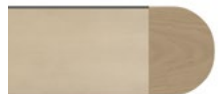

MODEL NUMBER	PRODUCT	WIDTH	DEPTH	HEIGHT	WEIGHT	VOLUME	LIST PRICE	DESCRIPTION
	PUZZLE RIGHT Tables:							Each table is constructed of a 1" thick top with a plastic laminate top surface.
	60" Width	60"	36"	29"	___ Lbs.	___ Cu Ft		There are three edge profiles available:
SO-PR-6036-AC-ST	Acrylic Edge; Straight Leg						\$ 975	
SO-PR-6036-AC-WC	Acrylic Edge; Wave Caster Leg						\$ 1,344	
SO-PR-6036-AC-WF	Acrylic Edge; Wave Fixed Leg						\$ 1,200	
SO-PR-6036-BN-ST	Bullnose Edge; Straight Leg						\$ 1,281	
SO-PR-6036-BN-WC	Bullnose Edge; Wave Caster Leg						\$ 1,650	
SO-PR-6036-BN-WF	Bullnose Edge; Wave Fixed Leg						\$ 1,338	
SO-PR-6036-SQ-ST	Square Edge; Straight Leg						\$ 1,169	
SO-PR-6036-SQ-WC	Square Edge; Wave Caster Leg						\$ 1,538	
SO-PR-6036-SQ-WF	Square Edge; Wave Fixed Leg						\$ 1,225	
	72" Width;	72"	36"	29"	___ Lbs.	___ Cu Ft		There are three different leg styles available:
SO-PR-7236-AC-ST	Acrylic Edge; Straight Leg						\$ 1,025	
SO-PR-7236-AC-WC	Acrylic Edge; Wave Caster Leg						\$ 1,394	
SO-PR-7236-AC-WF	Acrylic Edge; Wave Fixed Leg						\$ 1,081	
SO-PR-7236-BN-ST	Bullnose Edge; Straight Leg						\$ 1,369	
SO-PR-7236-BN-WC	Bullnose Edge; Wave Caster Leg						\$ 1,744	
SO-PR-7236-BN-WF	Bullnose Edge; Wave Fixed Leg						\$ 1,431	
SO-PR-7236-SQ-ST	Square Edge; Straight Leg						\$ 1,250	
SO-PR-7236-SQ-WC	Square Edge; Wave Caster Leg						\$ 1,619	
SO-PR-7236-SQ-WF	Square Edge; Wave Fixed Leg						\$ 1,306	
	PUZZLE LEFT Tables:							
	60" Width;	60"	36"	29"	___ Lbs.	___ Cu Ft		
SO-PL-6036-AC-ST	Acrylic Edge; Straight Leg						\$ 1,031	
SO-PL-6036-AC-WC	Acrylic Edge; Wave Caster Leg						\$ 1,344	
SO-PL-6036-AC-WF	Acrylic Edge; Wave Fixed Leg						\$ 1,031	
SO-PL-6036-BN-ST	Bullnose Edge; Straight Leg						\$ 1,281	
SO-PL-6036-BN-WC	Bullnose Edge; Wave Caster Leg						\$ 1,650	
SO-PL-6036-BN-WF	Bullnose Edge; Wave Fixed Leg						\$ 1,338	
SO-PL-6036-SQ-ST	Square Edge; Straight Leg						\$ 1,169	
SO-PL-6036-SQ-WC	Square Edge; Wave Caster Leg						\$ 1,538	
SO-PL-6036-SQ-WF	Square Edge; Wave Fixed Leg						\$ 1,225	
	72" Width;	72"	36"	29"	___ Lbs.	___ Cu Ft		
SO-PL-7236-AC-ST	Acrylic Edge; Straight Leg						\$ 1,081	
SO-PL-7236-AC-WC	Acrylic Edge; Wave Caster Leg						\$ 1,394	
SO-PL-7236-AC-WF	Acrylic Edge; Wave Fixed Leg						\$ 1,081	
SO-PL-7236-BN-ST	Bullnose Edge; Straight Leg						\$ 1,375	
SO-PL-7236-BN-WC	Bullnose Edge; Wave Caster Leg						\$ 1,744	
SO-PL-7236-BN-WF	Bullnose Edge; Wave Fixed Leg						\$ 1,431	
SO-PL-7236-SQ-ST	Square Edge; Straight Leg						\$ 1,250	
SO-PL-7236-SQ-WC	Square Edge; Wave Caster Leg						\$ 1,619	
SO-PL-7236-SQ-WF	Square Edge; Wave Fixed Leg						\$ 1,306	







MODEL NUMBER	PRODUCT	WIDTH	DEPTH	HEIGHT	WEIGHT	VOLUME	LIST PRICE	DESCRIPTION
	TRIANGLE Tables:							Each table is constructed of a 1" thick top with a plastic laminate top surface.
	24" Width;	24"	24"	29"	__ Lbs.	__ Cu Ft		There are three edge profiles available:
SO-TR-24-AC-ST	Acrylic Edge; Straight Leg						\$ 719	  
SO-TR-24-AC-WC	Acrylic Edge; Wave Caster Leg						\$ 994	
SO-TR-24-AC-WF	Acrylic Edge; Wave Fixed Leg						\$ 763	
SO-TR-24-BN-ST	Bullnose Edge; Straight Leg						\$ 838	  
SO-TR-24-BN-WC	Bullnose Edge; Wave Caster Leg						\$ 1,113	
SO-TR-24-BN-WF	Bullnose Edge; Wave Fixed Leg						\$ 881	
SO-TR-24-SQ-ST	Square Edge; Straight Leg						\$ 794	There are three different leg styles available:
SO-TR-24-SQ-WC	Square Edge; Wave Caster Leg						\$ 1,200	
SO-TR-24-SQ-WF	Square Edge; Wave Fixed Leg						\$ 838	
	30" Width;	30"	30"	29"	__ Lbs.	__ Cu Ft		
SO-TR-30-AC-ST	Acrylic Edge; Straight Leg						\$ 756	
SO-TR-30-AC-WC	Acrylic Edge; Wave Caster Leg						\$ 1,038	
SO-TR-30-AC-WF	Acrylic Edge; Wave Fixed Leg						\$ 800	
SO-TR-30-BN-ST	Bullnose Edge; Straight Leg						\$ 906	
SO-TR-30-BN-WC	Bullnose Edge; Wave Caster Leg						\$ 1,188	
SO-TR-30-BN-WF	Bullnose Edge; Wave Fixed Leg						\$ 950	
SO-TR-30-SQ-ST	Square Edge; Straight Leg						\$ 856	
SO-TR-30-SQ-WC	Square Edge; Wave Caster Leg						\$ 1,131	
SO-TR-30-SQ-WF	Square Edge; Wave Fixed Leg						\$ 894	







MODEL NUMBER	PRODUCT	WIDTH	DEPTH	HEIGHT	WEIGHT	VOLUME	LIST PRICE	DESCRIPTION
	CORNER WORKSTATIONS:							Each table is constructed of a 1" thick top with a plastic laminate top surface.
	42" Widths;							There are three edge profiles available:
SO-CWS-4224-AC-ST	Acrylic Edge; Straight Leg	42"	24"	29"	___ Lbs.	___ Cu Ft	\$ 981	
SO-CWS-4224-AC-WC	Acrylic Edge; Wave Caster Leg						\$ 1,444	
SO-CWS-4224-AC-WF	Acrylic Edge; Wave Fixed Leg						\$ 1,050	
SO-CWS-4224-BN-ST	Bullnose Edge; Straight Leg						\$ 1,244	
SO-CWS-4224-BN-WC	Bullnose Edge; Wave Caster Leg						\$ 1,706	
SO-CWS-4224-BN-WF	Bullnose Edge; Wave Fixed Leg						\$ 1,319	
SO-CWS-4224-SQ-ST	Square Edge; Straight Leg						\$ 1,150	
SO-CWS-4224-SQ-WC	Square Edge; Wave Caster Leg						\$ 1,613	
SO-CWS-4224-SQ-WF	Square Edge; Wave Fixed Leg						\$ 1,225	
SO-CWS-4230-AC-ST	Acrylic Edge; Straight Leg	42"	30"	29"	___ Lbs.	___ Cu Ft	\$ 988	
SO-CWS-4230-AC-WC	Acrylic Edge; Wave Caster Leg						\$ 1,450	
SO-CWS-4230-AC-WF	Acrylic Edge; Wave Fixed Leg						\$ 1,056	
SO-CWS-4230-BN-ST	Bullnose Edge; Straight Leg						\$ 1,250	
SO-CWS-4230-BN-WC	Bullnose Edge; Wave Caster Leg						\$ 1,713	
SO-CWS-4230-BN-WF	Bullnose Edge; Wave Fixed Leg						\$ 1,319	
SO-CWS-4230-SQ-ST	Square Edge; Straight Leg						\$ 1,156	
SO-CWS-4230-SQ-WC	Square Edge; Wave Caster Leg						\$ 1,619	
SO-CWS-4230-SQ-WF	Square Edge; Wave Fixed Leg						\$ 1,225	
	48" Widths;							There are three different leg styles available:
SO-CWS-4824-AC-ST	Acrylic Edge; Straight Leg	48"	24"	29"	___ Lbs.	___ Cu Ft	\$ 1,044	
SO-CWS-4824-AC-WC	Acrylic Edge; Wave Caster Leg						\$ 1,506	
SO-CWS-4824-AC-WF	Acrylic Edge; Wave Fixed Leg						\$ 1,119	
SO-CWS-4824-BN-ST	Bullnose Edge; Straight Leg						\$ 1,344	
SO-CWS-4824-BN-WC	Bullnose Edge; Wave Caster Leg						\$ 1,806	
SO-CWS-4824-BN-WF	Bullnose Edge; Wave Fixed Leg						\$ 1,419	
SO-CWS-4824-SQ-ST	Square Edge; Straight Leg						\$ 1,238	
SO-CWS-4824-SQ-WC	Square Edge; Wave Caster Leg						\$ 1,700	
SO-CWS-4824-SQ-WF	Square Edge; Wave Fixed Leg						\$ 1,313	
SO-CWS-4830-AC-ST	Acrylic Edge; Straight Leg	48"	30"	29"	___ Lbs.	___ Cu Ft	\$ 1,050	
SO-CWS-4830-AC-WC	Acrylic Edge; Wave Caster Leg						\$ 1,513	
SO-CWS-4830-AC-WF	Acrylic Edge; Wave Fixed Leg						\$ 1,119	
SO-CWS-4830-BN-ST	Bullnose Edge; Straight Leg						\$ 1,350	
SO-CWS-4830-BN-WC	Bullnose Edge; Wave Caster Leg						\$ 1,813	
SO-CWS-4830-BN-WF	Bullnose Edge; Wave Fixed Leg						\$ 1,419	
SO-CWS-4830-SQ-ST	Square Edge; Straight Leg						\$ 1,244	
SO-CWS-4830-SQ-WC	Square Edge; Wave Caster Leg						\$ 1,706	
SO-CWS-4830-SQ-WF	Square Edge; Wave Fixed Leg						\$ 1,313	







MODEL NUMBER	PRODUCT	WIDTH	DEPTH	HEIGHT	WEIGHT	VOLUME	LIST PRICE	DESCRIPTION
HALF END Tables:								Each table is constructed of a 1" thick top with a plastic laminate top surface.
RIGHT Conference;								There are three edge profiles available:
	TE-HER-6024-AC-ST TE-HER-6024-AC-WC TE-HER-6024-AC-WF TE-HER-6024-BN-ST TE-HER-6024-BN-WC TE-HER-6024-BN-WF TE-HER-6024-SQ-ST TE-HER-6024-SQ-WC TE-HER-6024-SQ-WF	60"	24"	29"	___ Lbs.	___ Cu Ft	\$ 888 \$ 1,256 \$ 944 \$ 1,150 \$ 1,519 \$ 1,206 \$ 1,056 \$ 1,425 \$ 1,113	 Model "AC" Acrylic Edge  Model "BN" 3/4" Bullnose Edge  Model "SQ" 1/4" Square Edge
	TE-HER-6030-AC-ST TE-HER-6030-AC-WC TE-HER-6030-AC-WF TE-HER-6030-BN-ST TE-HER-6030-BN-WC TE-HER-6030-BN-WF TE-HER-6030-SQ-ST TE-HER-6030-SQ-WC TE-HER-6030-SQ-WF	60"	30"	29"	___ Lbs.	___ Cu Ft	\$ 925 \$ 1,300 \$ 988 \$ 1,206 \$ 1,575 \$ 1,263 \$ 1,106 \$ 1,475 \$ 1,163	There are three different leg styles available:
	TE-HEL-6024-AC-ST TE-HEL-6024-AC-WC TE-HEL-6024-AC-WF TE-HEL-6024-BN-ST TE-HEL-6024-BN-WC TE-HEL-6024-BN-WF TE-HEL-6024-SQ-ST TE-HEL-6024-SQ-WC TE-HEL-6024-SQ-WF	60"	24"	29"	___ Lbs.	___ Cu Ft	\$ 888 \$ 1,256 \$ 944 \$ 1,150 \$ 1,519 \$ 1,206 \$ 1,056 \$ 1,425 \$ 1,113	 Model "ST" Straight 1 1/2" Diameter Leg  Model "WF" Wave Fixed Leg  Model "WC" Wave Caster Leg
	TE-HEL-6030-AC-ST TE-HEL-6030-AC-WC TE-HEL-6030-AC-WF TE-HEL-6030-BN-ST TE-HEL-6030-BN-WC TE-HEL-6030-BN-WF TE-HEL-6030-SQ-ST TE-HEL-6030-SQ-WC TE-HEL-6030-SQ-WF	60"	30"	29"	___ Lbs.	___ Cu Ft	\$ 925 \$ 1,300 \$ 988 \$ 1,206 \$ 1,575 \$ 1,263 \$ 1,106 \$ 1,475 \$ 1,163	









MODEL NUMBER	PRODUCT	WIDTH	DEPTH	HEIGHT	WEIGHT	VOLUME	LIST PRICE	DESCRIPTION
	END CAP Conference Tables:							Each table is constructed of a 1" thick top with a plastic laminate top surface.
	24" Depth;	60"	24"	29"	__ Lbs.	__ Cu Ft		There are three edge profiles available:
TE-EC-6024-AC-ST	Acrylic Edge; Straight Leg						\$ 888	  
TE-EC-6024-AC-WC	Acrylic Edge; Wave Caster Leg						\$ 1,263	
TE-EC-6024-AC-WF	Acrylic Edge; Wave Fixed Leg						\$ 950	
TE-EC-6024-BN-ST	Bullnose Edge; Straight Leg						\$ 1,150	<p>Model "AC" Model "BN" Model "SQ"</p> <p>Acrylic Edge 3/4" Bullnose Edge 1/4" Square Edge</p>
TE-EC-6024-BN-WC	Bullnose Edge; Wave Caster Leg						\$ 1,525	
TE-EC-6024-BN-WF	Bullnose Edge; Wave Fixed Leg						\$ 1,213	
TE-EC-6024-SQ-ST	Square Edge; Straight Leg						\$ 1,056	<p>There are three different leg styles available:</p>   
TE-EC-6024-SQ-WC	Square Edge; Wave Caster Leg						\$ 1,431	
TE-EC-6024-SQ-WF	Square Edge; Wave Fixed Leg						\$ 1,119	
	30" Depth;	60"	30"	29"	__ Lbs.	__ Cu Ft		
TE-EC-6030-AC-ST	Acrylic Edge; Straight Leg						\$ 931	<p>Model "ST" Model "WF" Model "WC"</p> <p>Straight 1 1/2" Wave Wave</p> <p>Diameter Leg Fixed Leg Caster Leg</p>
TE-EC-6030-AC-WC	Acrylic Edge; Wave Caster Leg						\$ 1,306	
TE-EC-6030-AC-WF	Acrylic Edge; Wave Fixed Leg						\$ 988	
TE-EC-6030-BN-ST	Bullnose Edge; Straight Leg						\$ 1,213	
TE-EC-6030-BN-WC	Bullnose Edge; Wave Caster Leg						\$ 1,581	
TE-EC-6030-BN-WF	Bullnose Edge; Wave Fixed Leg						\$ 1,269	
TE-EC-6030-SQ-ST	Square Edge; Straight Leg						\$ 1,113	
TE-EC-6030-SQ-WC	Square Edge; Wave Caster Leg						\$ 1,481	
TE-EC-6030-SQ-WF	Square Edge; Wave Fixed Leg						\$ 1,169	



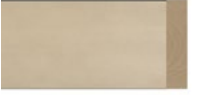

MODEL NUMBER	PRODUCT	WIDTH	DEPTH	HEIGHT	WEIGHT	VOLUME	LIST PRICE	DESCRIPTION
	CURVE Conference Tables, 24" Depths:							Each table is constructed of a 1" thick top with a plastic laminate top surface.
	30" Width;	30"	24"	29"	___ Lbs.	___ Cu Ft		There are three edge profiles available:
TE-CU-3024-AC-ST	Acrylic Edge; Straight Leg						\$ 794	
TE-CU-3024-AC-WC	Acrylic Edge; Wave Caster Leg						\$ 1,163	
TE-CU-3024-AC-WF	Acrylic Edge; Wave Fixed Leg						\$ 850	
TE-CU-3024-BN-ST	Bullnose Edge; Straight Leg						\$ 975	Model "AC" Acrylic Edge
TE-CU-3024-BN-WC	Bullnose Edge; Wave Caster Leg						\$ 1,344	Model "BN" 3/4" Bullnose Edge
TE-CU-3024-BN-WF	Bullnose Edge; Wave Fixed Leg						\$ 1,031	Model "SQ" 1/4" Square Edge
TE-CU-3024-SQ-ST	Square Edge; Straight Leg						\$ 913	
TE-CU-3024-SQ-WC	Square Edge; Wave Caster Leg						\$ 1,281	
TE-CU-3024-SQ-WF	Square Edge; Wave Fixed Leg						\$ 969	
	36" Width;	36"	24"	29"	___ Lbs.	___ Cu Ft		There are three different leg styles available:
TE-CU-3624-AC-ST	Acrylic Edge; Straight Leg						\$ 813	
TE-CU-3624-AC-WC	Acrylic Edge; Wave Caster Leg						\$ 1,181	
TE-CU-3624-AC-WF	Acrylic Edge; Wave Fixed Leg						\$ 869	
TE-CU-3624-BN-ST	Bullnose Edge; Straight Leg						\$ 1,013	Model "ST" Straight 1 1/2" Diameter Leg
TE-CU-3624-BN-WC	Bullnose Edge; Wave Caster Leg						\$ 1,381	Model "WF" Wave Fixed Leg
TE-CU-3624-BN-WF	Bullnose Edge; Wave Fixed Leg						\$ 1,069	Model "WC" Wave Caster Leg
TE-CU-3624-SQ-ST	Square Edge; Straight Leg						\$ 944	
TE-CU-3624-SQ-WC	Square Edge; Wave Caster Leg						\$ 1,313	
TE-CU-3624-SQ-WF	Square Edge; Wave Fixed Leg						\$ 1,000	
	42" Width;	42"	24"	29"	___ Lbs.	___ Cu Ft		
TE-CU-4224-AC-ST	Acrylic Edge; Straight Leg						\$ 831	
TE-CU-4224-AC-WC	Acrylic Edge; Wave Caster Leg						\$ 1,200	
TE-CU-4224-AC-WF	Acrylic Edge; Wave Fixed Leg						\$ 888	
TE-CU-4224-BN-ST	Bullnose Edge; Straight Leg						\$ 1,050	
TE-CU-4224-BN-WC	Bullnose Edge; Wave Caster Leg						\$ 1,419	
TE-CU-4224-BN-WF	Bullnose Edge; Wave Fixed Leg						\$ 1,106	
TE-CU-4224-SQ-ST	Square Edge; Straight Leg						\$ 975	
TE-CU-4224-SQ-WC	Square Edge; Wave Caster Leg						\$ 1,344	
TE-CU-4224-SQ-WF	Square Edge; Wave Fixed Leg						\$ 1,031	





MODEL NUMBER	PRODUCT	WIDTH	DEPTH	HEIGHT	WEIGHT	VOLUME	LIST PRICE	DESCRIPTION
	CURVE Conference Tables, 24" Depths:							Each table is constructed of a 1" thick top with a plastic laminate top surface.
	48" Width;	48"	24"	29"	___ Lbs.	___ Cu Ft		There are three edge profiles available:
TE-CU-4824-AC-ST	Acrylic Edge; Straight Leg						\$ 850	
TE-CU-4824-AC-WC	Acrylic Edge; Wave Caster Leg						\$ 1,219	
TE-CU-4824-AC-WF	Acrylic Edge; Wave Fixed Leg						\$ 906	
TE-CU-4824-BN-ST	Bullnose Edge; Straight Leg						\$ 1,088	Model "AC" Acrylic Edge
TE-CU-4824-BN-WC	Bullnose Edge; Wave Caster Leg						\$ 1,456	Model "BN" 3/4" Bullnose Edge
TE-CU-4824-BN-WF	Bullnose Edge; Wave Fixed Leg						\$ 1,144	Model "SQ" 1/4" Square Edge
TE-CU-4824-SO-ST	Square Edge; Straight Leg						\$ 1,006	
TE-CU-4824-SO-WC	Square Edge; Wave Caster Leg						\$ 1,375	
TE-CU-4824-SO-WF	Square Edge; Wave Fixed Leg						\$ 1,063	
	54" Width;	54"	24"	29"	___ Lbs.	___ Cu Ft		There are three different leg styles available:
TE-CU-5424-AC-ST	Acrylic Edge; Straight Leg						\$ 869	
TE-CU-5424-AC-WC	Acrylic Edge; Wave Caster Leg						\$ 1,238	
TE-CU-5424-AC-WF	Acrylic Edge; Wave Fixed Leg						\$ 925	
TE-CU-5424-BN-ST	Bullnose Edge; Straight Leg						\$ 1,125	Model "ST" Straight 1 1/2" Diameter Leg
TE-CU-5424-BN-WC	Bullnose Edge; Wave Caster Leg						\$ 1,500	Model "WF" Wave Fixed Leg
TE-CU-5424-BN-WF	Bullnose Edge; Wave Fixed Leg						\$ 1,181	Model "WC" Wave Caster Leg
TE-CU-5424-SO-ST	Square Edge; Straight Leg						\$ 1,031	
TE-CU-5424-SO-WC	Square Edge; Wave Caster Leg						\$ 1,406	
TE-CU-5424-SO-WF	Square Edge; Wave Fixed Leg						\$ 1,094	
	60" Width;	60"	24"	29"	___ Lbs.	___ Cu Ft		
TE-CU-6024-AC-ST	Acrylic Edge; Straight Leg						\$ 888	
TE-CU-6024-AC-WC	Acrylic Edge; Wave Caster Leg						\$ 1,256	
TE-CU-6024-AC-WF	Acrylic Edge; Wave Fixed Leg						\$ 944	
TE-CU-6024-BN-ST	Bullnose Edge; Straight Leg						\$ 1,163	
TE-CU-6024-BN-WC	Bullnose Edge; Wave Caster Leg						\$ 1,538	
TE-CU-6024-BN-WF	Bullnose Edge; Wave Fixed Leg						\$ 1,219	
TE-CU-6024-SO-ST	Square Edge; Straight Leg						\$ 1,063	
TE-CU-6024-SO-WC	Square Edge; Wave Caster Leg						\$ 1,438	
TE-CU-6024-SO-WF	Square Edge; Wave Fixed Leg						\$ 1,125	





MODEL NUMBER	PRODUCT	WIDTH	DEPTH	HEIGHT	WEIGHT	VOLUME	LIST PRICE	DESCRIPTION
	CURVE Conference Tables, 30" Depths:							Each table is constructed of a 1" thick top with a plastic laminate top surface.
	30" Width;	30"	30"	29"	__ Lbs.	__ Cu Ft		There are three edge profiles available:
TE-CU-3030-AC-ST	Acrylic Edge; Straight Leg						\$ 819	
TE-CU-3030-AC-WC	Acrylic Edge; Wave Caster Leg						\$ 1,188	
TE-CU-3030-AC-WF	Acrylic Edge; Wave Fixed Leg						\$ 875	
TE-CU-3030-BN-ST	Bullnose Edge; Straight Leg						\$ 1,019	Model "AC" Acrylic Edge
TE-CU-3030-BN-WC	Bullnose Edge; Wave Caster Leg						\$ 1,388	Model "BN" 3/4" Bullnose Edge
TE-CU-3030-BN-WF	Bullnose Edge; Wave Fixed Leg						\$ 1,075	Model "SQ" 1/4" Square Edge
TE-CU-3030-SQ-ST	Square Edge; Straight Leg						\$ 944	
TE-CU-3030-SQ-WC	Square Edge; Wave Caster Leg						\$ 1,319	
TE-CU-3030-SQ-WF	Square Edge; Wave Fixed Leg						\$ 1,000	
	36" Width;	36"	30"	29"	__ Lbs.	__ Cu Ft		There are three different leg styles available:
TE-CU-3630-AC-ST	Acrylic Edge; Straight Leg						\$ 838	
TE-CU-3630-AC-WC	Acrylic Edge; Wave Caster Leg						\$ 1,213	
TE-CU-3630-AC-WF	Acrylic Edge; Wave Fixed Leg						\$ 894	
TE-CU-3630-BN-ST	Bullnose Edge; Straight Leg						\$ 1,056	Model "ST" Straight 1 1/2" Diameter Leg
TE-CU-3630-BN-WC	Bullnose Edge; Wave Caster Leg						\$ 1,431	Model "WF" Wave Fixed Leg
TE-CU-3630-BN-WF	Bullnose Edge; Wave Fixed Leg						\$ 1,119	Model "WC" Wave Caster Leg
TE-CU-3630-SQ-ST	Square Edge; Straight Leg						\$ 981	
TE-CU-3630-SQ-WC	Square Edge; Wave Caster Leg						\$ 1,350	
TE-CU-3630-SQ-WF	Square Edge; Wave Fixed Leg						\$ 1,038	
	42" Width;	42"	30"	29"	__ Lbs.	__ Cu Ft		
TE-CU-4230-AC-ST	Acrylic Edge; Straight Leg						\$ 863	
TE-CU-4230-AC-WC	Acrylic Edge; Wave Caster Leg						\$ 1,231	
TE-CU-4230-AC-WF	Acrylic Edge; Wave Fixed Leg						\$ 919	
TE-CU-4230-BN-ST	Bullnose Edge; Straight Leg						\$ 1,100	
TE-CU-4230-BN-WC	Bullnose Edge; Wave Caster Leg						\$ 1,469	
TE-CU-4230-BN-WF	Bullnose Edge; Wave Fixed Leg						\$ 1,156	
TE-CU-4230-SQ-ST	Square Edge; Straight Leg						\$ 1,019	
TE-CU-4230-SQ-WC	Square Edge; Wave Caster Leg						\$ 1,388	
TE-CU-4230-SQ-WF	Square Edge; Wave Fixed Leg						\$ 1,075	

MODEL NUMBER	PRODUCT	WIDTH	DEPTH	HEIGHT	WEIGHT	VOLUME	LIST PRICE	DESCRIPTION
	CURVE Conference Tables, 30" Depths:							Each table is constructed of a 1" thick top with a plastic laminate top surface.
	48" Width;	48"	30"	29"	__ Lbs.	__ Cu Ft		There are three edge profiles available:
TE-CU-4830-AC-ST	Acrylic Edge; Straight Leg						\$ 881	
TE-CU-4830-AC-WC	Acrylic Edge; Wave Caster Leg						\$ 1,256	
TE-CU-4830-AC-WF	Acrylic Edge; Wave Fixed Leg						\$ 944	
TE-CU-4830-BN-ST	Bullnose Edge; Straight Leg						\$ 1,144	Model "AC" Acrylic Edge
TE-CU-4830-BN-WC	Bullnose Edge; Wave Caster Leg						\$ 1,513	Model "BN" 3/4" Bullnose Edge
TE-CU-4830-BN-WF	Bullnose Edge; Wave Fixed Leg						\$ 1,200	Model "SQ" 1/4" Square Edge
TE-CU-4830-SQ-ST	Square Edge; Straight Leg						\$ 1,050	
TE-CU-4830-SQ-WC	Square Edge; Wave Caster Leg						\$ 1,419	
TE-CU-4830-SQ-WF	Square Edge; Wave Fixed Leg						\$ 1,106	
	54" Width;	54"	30"	29"	__ Lbs.	__ Cu Ft		There are three different leg styles available:
TE-CU-5430-AC-ST	Acrylic Edge; Straight Leg						\$ 906	
TE-CU-5430-AC-WC	Acrylic Edge; Wave Caster Leg						\$ 1,275	
TE-CU-5430-AC-WF	Acrylic Edge; Wave Fixed Leg						\$ 963	
TE-CU-5430-BN-ST	Bullnose Edge; Straight Leg						\$ 1,188	Model "ST" Straight 1 1/2" Diameter Leg
TE-CU-5430-BN-WC	Bullnose Edge; Wave Caster Leg						\$ 1,556	Model "WF" Wave Fixed Leg
TE-CU-5430-BN-WF	Bullnose Edge; Wave Fixed Leg						\$ 1,244	Model "WC" Wave Caster Leg
TE-CU-5430-SQ-ST	Square Edge; Straight Leg						\$ 1,088	
TE-CU-5430-SQ-WC	Square Edge; Wave Caster Leg						\$ 1,456	
TE-CU-5430-SQ-WF	Square Edge; Wave Fixed Leg						\$ 1,144	
	60" Width;	60"	30"	29"	__ Lbs.	__ Cu Ft		
TE-CU-6030-AC-ST	Acrylic Edge; Straight Leg						\$ 931	
TE-CU-6030-AC-WC	Acrylic Edge; Wave Caster Leg						\$ 1,300	
TE-CU-6030-AC-WF	Acrylic Edge; Wave Fixed Leg						\$ 988	
TE-CU-6030-BN-ST	Bullnose Edge; Straight Leg						\$ 1,225	
TE-CU-6030-BN-WC	Bullnose Edge; Wave Caster Leg						\$ 1,600	
TE-CU-6030-BN-WF	Bullnose Edge; Wave Fixed Leg						\$ 1,288	
TE-CU-6030-SQ-ST	Square Edge; Straight Leg						\$ 1,119	
TE-CU-6030-SQ-WC	Square Edge; Wave Caster Leg						\$ 1,494	
TE-CU-6030-SQ-WF	Square Edge; Wave Fixed Leg						\$ 1,175	

MODEL NUMBER	PRODUCT	WIDTH	DEPTH	HEIGHT	WEIGHT	VOLUME	LIST PRICE	DESCRIPTION
	ROUND END Conference Tables:	72"	48"	29"	__ Lbs.	__ Cu Ft		Each table is constructed of a 1" thick top with a plastic laminate top surface.
TE-RE-7248-AC-ST	Acrylic Edge; Straight Leg						\$ 1,706	There are three edge profiles available:  Model "AC" Acrylic Edge  Model "BN" 3/4" Bullnose Edge  Model "SQ" 1/4" Square Edge
TE-RE-7248-AC-WC	Acrylic Edge; Wave Caster Leg						\$ 2,263	
TE-RE-7248-AC-WF	Acrylic Edge; Wave Fixed Leg						\$ 1,794	
TE-RE-7248-BN-ST	Bullnose Edge; Straight Leg						\$ 2,069	
TE-RE-7248-BN-WC	Bullnose Edge; Wave Caster Leg						\$ 2,625	
TE-RE-7248-BN-WF	Bullnose Edge; Wave Fixed Leg						\$ 2,156	
TE-RE-7248-SQ-ST	Square Edge; Straight Leg						\$ 1,944	
TE-RE-7248-SQ-WC	Square Edge; Wave Caster Leg						\$ 2,500	
TE-RE-7248-SQ-WF	Square Edge; Wave Fixed Leg						\$ 2,025	
	SQUARE Computer Stations, T-Base:							There are three different leg styles available:  Model "ST" Straight 1 1/2" Diameter Leg  Model "WF" Wave Fixed Leg  Model "WC" Wave Caster Leg
	30" Width;	30"	30"	29"	__ Lbs.	__ Cu Ft		
TE-3030-AC-TF	Acrylic Edge; T-Base Fixed						\$ 1,256	
TE-3030-AC-TC	Acrylic Edge; T-Base Caster						\$ 1,513	
TE-3030-BN-TF	Bullnose Edge; T-Base Fixed						\$ 1,456	
TE-3030-BN-TC	Bullnose Edge; T-Base Caster						\$ 1,713	
TE-3030-SQ-TF	Square Edge; T-Base Fixed						\$ 1,381	
TE-3030-SQ-TC	Square Edge; T-Base Caster						\$ 1,638	
	36" Width;	36"	36"	29"	__ Lbs.	__ Cu Ft		
TE-3636-AC-TF	Acrylic Edge; T-Base Fixed						\$ 1,306	The T-Base is constructed of double support 1" x 2" tubular 16 gauge steel with a 3" wide perforated screen separation and an integrated modesty J-Channel for wire management. One 3" wide grommet at center. Model "TF" is T-Base Fixed, and "TC" is T-Base Caster. 
TE-3636-AC-TC	Acrylic Edge; T-Base Caster						\$ 1,563	
TE-3636-BN-TF	Bullnose Edge; T-Base Fixed						\$ 1,544	
TE-3636-BN-TC	Bullnose Edge; T-Base Caster						\$ 1,800	
TE-3636-SQ-TF	Square Edge; T-Base Fixed						\$ 1,456	
TE-3636-SQ-TC	Square Edge; T-Base Caster						\$ 1,713	

MODEL NUMBER	PRODUCT	WIDTH	DEPTH	HEIGHT	WEIGHT	VOLUME	LIST PRICE	DESCRIPTION
 TE-3630-AC-TF TE-3630-AC-TC TE-3630-BN-TF TE-3630-BN-TC TE-3630-SQ-TF TE-3630-SQ-TC	RECTANGLE Computer Stations, T-Base, 30" Depths:							Each table is constructed of a 1" thick top with a plastic laminate top surface.
	36" Width;	36"	30"	29"	___ Lbs.	___ Cu Ft		There are three edge profiles available:
	Acrylic Edge; T-Base Fixed						\$ 1,275	  
	Acrylic Edge; T-Base Caster						\$ 1,531	
	Bullnose Edge; T-Base Fixed						\$ 1,500	
	Bullnose Edge; T-Base Caster						\$ 1,756	
Square Edge; T-Base Fixed						\$ 1,419		
Square Edge; T-Base Caster						\$ 1,675		
	42" Width;	42"	30"	29"	___ Lbs.	___ Cu Ft		The T-Base is constructed of double support 1" x 2" tubular 16 gauge steel with a 3" wide perforated screen separation and an integrated modesty J-Channel for wire management. One 3" wide grommet at center. Model "TF" is T-Base Fixed, and "TC" is T-Base Caster.
TE-4230-AC-TF TE-4230-AC-TC TE-4230-BN-TF TE-4230-BN-TC TE-4230-SQ-TF TE-4230-SQ-TC	Acrylic Edge; T-Base Fixed						\$ 1,338	
	Acrylic Edge; T-Base Caster						\$ 1,594	
	Bullnose Edge; T-Base Fixed						\$ 1,575	
	Bullnose Edge; T-Base Caster						\$ 1,831	
	Square Edge; T-Base Fixed						\$ 1,494	
	Square Edge; T-Base Caster						\$ 1,750	
	48" Width;	48"	30"	29"	___ Lbs.	___ Cu Ft		
TE-4830-AC-TF TE-4830-AC-TC TE-4830-BN-TF TE-4830-BN-TC TE-4830-SQ-TF TE-4830-SQ-TC	Acrylic Edge; T-Base Fixed						\$ 1,388	
	Acrylic Edge; T-Base Caster						\$ 1,644	
	Bullnose Edge; T-Base Fixed						\$ 1,650	
	Bullnose Edge; T-Base Caster						\$ 1,906	
	Square Edge; T-Base Fixed						\$ 1,556	
	Square Edge; T-Base Caster						\$ 1,813	

MODEL NUMBER	PRODUCT	WIDTH	DEPTH	HEIGHT	WEIGHT	VOLUME	LIST PRICE	DESCRIPTION
 TE-5430-AC-TF TE-5430-AC-TC TE-5430-BN-TF TE-5430-BN-TC TE-5430-SQ-TF TE-5430-SQ-TC	RECTANGLE Computer Stations, T-Base, 30" Depths:							Each table is constructed of a 1" thick top with a plastic laminate top surface.
	54" Width;	54"	30"	29"	___ Lbs.	___ Cu Ft		There are three edge profiles available:
	Acrylic Edge; T-Base Fixed						\$ 1,413	  
	Acrylic Edge; T-Base Caster						\$ 1,669	
	Bullnose Edge; T-Base Fixed						\$ 1,688	
	Bullnose Edge; T-Base Caster						\$ 1,944	
Square Edge; T-Base Fixed						\$ 1,588		
Square Edge; T-Base Caster						\$ 1,844		
 TE-6030-AC-TF TE-6030-AC-TC TE-6030-BN-TF TE-6030-BN-TC TE-6030-SQ-TF TE-6030-SQ-TC	60" Width;	60"	30"	29"	___ Lbs.	___ Cu Ft		The T-Base is constructed of double support 1" x 2" tubular 16 gauge steel with a 3" wide perforated screen separation and an integrated modesty J-Channel for wire management. One 3" wide grommet at center. Model "TF" is T-Base Fixed, and "TC" is T-Base Caster.
	Acrylic Edge; T-Base Fixed						\$ 1,431	
	Acrylic Edge; T-Base Caster						\$ 1,688	
	Bullnose Edge; T-Base Fixed						\$ 1,731	
	Bullnose Edge; T-Base Caster						\$ 1,988	
	Square Edge; T-Base Fixed						\$ 1,625	
Square Edge; T-Base Caster						\$ 1,881		
 TE-7230-AC-TF TE-7230-AC-TC TE-7230-BN-TF TE-7230-BN-TC TE-7230-SQ-TF TE-7230-SQ-TC	72" Width;	72"	30"	29"	___ Lbs.	___ Cu Ft		
	Acrylic Edge; T-Base Fixed						\$ 1,650	
	Acrylic Edge; T-Base Caster						\$ 1,906	
	Bullnose Edge; T-Base Fixed						\$ 1,988	
	Bullnose Edge; T-Base Caster						\$ 2,250	
	Square Edge; T-Base Fixed						\$ 1,869	
Square Edge; T-Base Caster						\$ 2,125		

MODEL NUMBER	PRODUCT	WIDTH	DEPTH	HEIGHT	WEIGHT	VOLUME	LIST PRICE	DESCRIPTION
	RECTANGLE Computer Stations, T-Base, 36" Depths:							Each table is constructed of a 1" thick top with a plastic laminate top surface.
	42" Width;	42"	36"	29"	__ Lbs.	__ Cu Ft		There are three edge profiles available:
TE-4236-AC-TF	Acrylic Edge; T-Base Fixed						\$ 1,325	
TE-4236-AC-TC	Acrylic Edge; T-Base Caster						\$ 1,625	
TE-4236-BN-TF	Bullnose Edge; T-Base Fixed						\$ 1,625	
TE-4236-BN-TC	Bullnose Edge; T-Base Caster						\$ 1,888	
TE-4236-SQ-TF	Square Edge; T-Base Fixed						\$ 1,538	
TE-4236-SQ-TC	Square Edge; T-Base Caster						\$ 1,794	
	48" Width;	48"	36"	29"	__ Lbs.	__ Cu Ft		The T-Base is constructed of double support 1" x 2" tubular 16 gauge steel with a 3" wide perforated screen separation and an integrated modesty J-Channel for wire management. One 3" wide grommet at center. Model "TF" is T-Base Fixed, and "TC" is T-Base Caster.
TE-4836-AC-TF	Acrylic Edge; T-Base Fixed						\$ 1,425	
TE-4836-AC-TC	Acrylic Edge; T-Base Caster						\$ 1,681	
TE-4836-BN-TF	Bullnose Edge; T-Base Fixed						\$ 1,700	
TE-4836-BN-TC	Bullnose Edge; T-Base Caster						\$ 1,956	
TE-4836-SQ-TF	Square Edge; T-Base Fixed						\$ 1,600	
TE-4836-SQ-TC	Square Edge; T-Base Caster						\$ 1,856	
	54" Width;	54"	36"	29"	__ Lbs.	__ Cu Ft		
TE-5436-AC-TF	Acrylic Edge; T-Base Fixed						\$ 1,450	
TE-5436-AC-TC	Acrylic Edge; T-Base Caster						\$ 1,706	
TE-5436-BN-TF	Bullnose Edge; T-Base Fixed						\$ 1,750	
TE-5436-BN-TC	Bullnose Edge; T-Base Caster						\$ 2,006	
TE-5436-SQ-TF	Square Edge; T-Base Fixed						\$ 1,644	
TE-5436-SQ-TC	Square Edge; T-Base Caster						\$ 1,900	
	60" Width;	60"	36"	29"	__ Lbs.	__ Cu Ft		
TE-6036-AC-TF	Acrylic Edge; T-Base Fixed						\$ 1,488	
TE-6036-AC-TC	Acrylic Edge; T-Base Caster						\$ 1,744	
TE-6036-BN-TF	Bullnose Edge; T-Base Fixed						\$ 1,806	
TE-6036-BN-TC	Bullnose Edge; T-Base Caster						\$ 2,063	
TE-6036-SQ-TF	Square Edge; T-Base Fixed						\$ 1,694	
TE-6036-SQ-TC	Square Edge; T-Base Caster						\$ 1,950	
	72" Width;	72"	36"	29"	__ Lbs.	__ Cu Ft		
TE-7236-AC-TF	Acrylic Edge; T-Base Fixed						\$ 1,700	
TE-7236-AC-TC	Acrylic Edge; T-Base Caster						\$ 1,956	
TE-7236-BN-TF	Bullnose Edge; T-Base Fixed						\$ 2,063	
TE-7236-BN-TC	Bullnose Edge; T-Base Caster						\$ 2,319	
TE-7236-SQ-TF	Square Edge; T-Base Fixed						\$ 1,931	
TE-7236-SQ-TC	Square Edge; T-Base Caster						\$ 2,188	







Model "AC"
Acrylic Edge







Model "BN"
3/4" Bullnose Edge

Model "SQ"
1/4" Square Edge











MODEL NUMBER	PRODUCT	WIDTH	DEPTH	HEIGHT	WEIGHT	VOLUME	LIST PRICE	DESCRIPTION
	PUZZLE RIGHT, Computer Stations, T-Base:							<p>Each table is constructed of a 1" thick top with a plastic laminate top surface.</p> <p>There are three edge profiles available:</p>  <p>Model "AC" Acrylic Edge Model "BN" 3/4" Bullnose Edge Model "SQ" 1/4" Square Edge</p>
	60" Width;	60"	36"	29"	__ Lbs.	__ Cu Ft		
	TE-PR-6036-AC-TF	Acrylic Edge; T-Base Fixed					\$ 1,488	
	TE-PR-6036-AC-TC	Acrylic Edge; T-Base Caster					\$ 1,744	
	TE-PR-6036-BN-TF	Bullnose Edge; T-Base Fixed					\$ 1,806	
	TE-PR-6036-BN-TC	Bullnose Edge; T-Base Caster					\$ 2,063	
	TE-PR-6036-SQ-TF	Square Edge; T-Base Fixed					\$ 1,694	
TE-PR-6036-SQ-TC	Square Edge; T-Base Caster					\$ 1,950		
	72" Width;	72"	36"	29"	__ Lbs.	__ Cu Ft		<p>The T-Base is constructed of double support 1" x 2" tubular 16 gauge steel with a 3" wide perforated screen separation and an integrated modesty J-Channel for wire management. One 3" wide grommet at center. Model "TF" is T-Base Fixed, and "TC" is T-Base Caster.</p> 
TE-PR-7236-AC-TF	Acrylic Edge; T-Base Fixed					\$ 1,700		
TE-PR-7236-AC-TC	Acrylic Edge; T-Base Caster					\$ 1,956		
TE-PR-7236-BN-TF	Bullnose Edge; T-Base Fixed					\$ 2,063		
TE-PR-7236-BN-TC	Bullnose Edge; T-Base Caster					\$ 2,319		
TE-PR-7236-SQ-TF	Square Edge; T-Base Fixed					\$ 1,931		
TE-PR-7236-SQ-TC	Square Edge; T-Base Caster					\$ 2,188		
	PUZZLE LEFT, Computer Stations, T-Base:							
	60" Width;	60"	36"	29"	__ Lbs.	__ Cu Ft		
	TE-PL-6036-AC-TF	Acrylic Edge; T-Base Fixed					\$ 1,488	
	TE-PL-6036-AC-TC	Acrylic Edge; T-Base Caster					\$ 1,744	
	TE-PL-6036-BN-TF	Bullnose Edge; T-Base Fixed					\$ 1,806	
	TE-PL-6036-BN-TC	Bullnose Edge; T-Base Caster					\$ 2,063	
	TE-PL-6036-SQ-TF	Square Edge; T-Base Fixed					\$ 1,694	
TE-PL-6036-SQ-TC	Square Edge; T-Base Caster					\$ 1,950		
	72" Width;	72"	36"	29"	__ Lbs.	__ Cu Ft		
TE-PL-7236-AC-TF	Acrylic Edge; T-Base Fixed					\$ 1,700		
TE-PL-7236-AC-TC	Acrylic Edge; T-Base Caster					\$ 1,956		
TE-PL-7236-BN-TF	Bullnose Edge; T-Base Fixed					\$ 2,063		
TE-PL-7236-BN-TC	Bullnose Edge; T-Base Caster					\$ 2,319		
TE-PL-7236-SQ-TF	Square Edge; T-Base Fixed					\$ 1,931		
TE-PL-7236-SQ-TC	Square Edge; T-Base Caster					\$ 2,188		





MODEL NUMBER	PRODUCT	WIDTH	DEPTH	HEIGHT	WEIGHT	VOLUME	LIST PRICE	DESCRIPTION
	SQUARE Computer Station, Leg Base:							Each table is constructed of a 1" thick top with a plastic laminate top surface.
	30" Width;	30"	30"	29"	__ Lbs.	__ Cu Ft		There are three edge profiles available:
TE-3030-AC-ST	Acrylic Edge; Straight Leg						\$ 856	
TE-3030-AC-WC	Acrylic Edge; Wave Caster Leg						\$ 1,225	
TE-3030-AC-WF	Acrylic Edge; Wave Fixed Leg						\$ 913	
TE-3030-BN-ST	Bullnose Edge; Straight Leg						\$ 1,056	
TE-3030-BN-WC	Bullnose Edge; Wave Caster Leg						\$ 1,425	
TE-3030-BN-WF	Bullnose Edge; Wave Fixed Leg						\$ 1,113	
TE-3030-SQ-ST	Square Edge; Straight Leg						\$ 981	
TE-3030-SQ-WC	Square Edge; Wave Caster Leg						\$ 1,356	
TE-3030-SQ-WF	Square Edge; Wave Fixed Leg						\$ 1,044	
	36" Width;	36"	36"	29"	__ Lbs.	__ Cu Ft		There are three different leg styles available:
TE-3636-AC-ST	Acrylic Edge; Straight Leg						\$ 888	
TE-3636-AC-WC	Acrylic Edge; Wave Caster Leg						\$ 1,256	
TE-3636-AC-WF	Acrylic Edge; Wave Fixed Leg						\$ 944	
TE-3636-BN-ST	Bullnose Edge; Straight Leg						\$ 1,125	
TE-3636-BN-WC	Bullnose Edge; Wave Caster Leg						\$ 1,500	
TE-3636-BN-WF	Bullnose Edge; Wave Fixed Leg						\$ 1,188	
TE-3636-SQ-ST	Square Edge; Straight Leg						\$ 1,044	
TE-3636-SQ-WC	Square Edge; Wave Caster Leg						\$ 1,413	
TE-3636-SQ-WF	Square Edge; Wave Fixed Leg						\$ 1,100	

















MODEL NUMBER	PRODUCT	WIDTH	DEPTH	HEIGHT	WEIGHT	VOLUME	LIST PRICE	DESCRIPTION
	RECTANGLE Computer Station, Leg Base, 30" Depths:							Each table is constructed of a 1" thick top with a plastic laminate top surface.
	36" Width;	36"	30"	29"	___ Lbs.	___ Cu Ft		There are three edge profiles available:
TE-3630-AC-ST	Acrylic Edge; Straight Leg						\$ 919	 <p>Model "AC" Acrylic Edge Model "BN" 3/4" Bullnose Edge Model "SQ" 1/4" Square Edge</p>
TE-3630-AC-WC	Acrylic Edge; Wave Caster Leg						\$ 1,288	
TE-3630-AC-WF	Acrylic Edge; Wave Fixed Leg						\$ 975	
TE-3630-BN-ST	Bullnose Edge; Straight Leg						\$ 1,138	
TE-3630-BN-WC	Bullnose Edge; Wave Caster Leg						\$ 1,506	
TE-3630-BN-WF	Bullnose Edge; Wave Fixed Leg						\$ 1,194	
TE-3630-SQ-ST	Square Edge; Straight Leg						\$ 1,056	
TE-3630-SQ-WC	Square Edge; Wave Caster Leg						\$ 1,425	
TE-3630-SQ-WF	Square Edge; Wave Fixed Leg						\$ 1,113	
	42" Width;	42"	30"	29"	___ Lbs.	___ Cu Ft		There are three different leg styles available:
TE-4230-AC-ST	Acrylic Edge; Straight Leg						\$ 938	 <p>Model "ST" Straight 1 1/2" Diameter Leg Model "WF" Wave Fixed Leg Model "WC" Wave Caster Leg</p>
TE-4230-AC-WC	Acrylic Edge; Wave Caster Leg						\$ 1,306	
TE-4230-AC-WF	Acrylic Edge; Wave Fixed Leg						\$ 994	
TE-4230-BN-ST	Bullnose Edge; Straight Leg						\$ 1,175	
TE-4230-BN-WC	Bullnose Edge; Wave Caster Leg						\$ 1,550	
TE-4230-BN-WF	Bullnose Edge; Wave Fixed Leg						\$ 1,231	
TE-4230-SQ-ST	Square Edge; Straight Leg						\$ 1,094	
TE-4230-SQ-WC	Square Edge; Wave Caster Leg						\$ 1,463	
TE-4230-SQ-WF	Square Edge; Wave Fixed Leg						\$ 1,150	
	48" Width;	48"	30"	29"	___ Lbs.	___ Cu Ft		
TE-4830-AC-ST	Acrylic Edge; Straight Leg						\$ 963	
TE-4830-AC-WC	Acrylic Edge; Wave Caster Leg						\$ 1,331	
TE-4830-AC-WF	Acrylic Edge; Wave Fixed Leg						\$ 1,019	
TE-4830-BN-ST	Bullnose Edge; Straight Leg						\$ 1,219	
TE-4830-BN-WC	Bullnose Edge; Wave Caster Leg						\$ 1,588	
TE-4830-BN-WF	Bullnose Edge; Wave Fixed Leg						\$ 1,275	
TE-4830-SQ-ST	Square Edge; Straight Leg						\$ 1,125	
TE-4830-SQ-WC	Square Edge; Wave Caster Leg						\$ 1,500	
TE-4830-SQ-WF	Square Edge; Wave Fixed Leg						\$ 1,181	

MODEL NUMBER	PRODUCT	WIDTH	DEPTH	HEIGHT	WEIGHT	VOLUME	LIST PRICE	DESCRIPTION
	RECTANGLE Computer Station, Leg Base, 30" Depths:							Each table is constructed of a 1" thick top with a plastic laminate top surface.
	54" Width;	54"	30"	29"	___ Lbs.	___ Cu Ft		There are three edge profiles available:
TE-5430-AC-ST	Acrylic Edge; Straight Leg						\$ 981	
TE-5430-AC-WC	Acrylic Edge; Wave Caster Leg						\$ 1,350	
TE-5430-AC-WF	Acrylic Edge; Wave Fixed Leg						\$ 1,038	
TE-5430-BN-ST	Bullnose Edge; Straight Leg						\$ 1,263	
TE-5430-BN-WC	Bullnose Edge; Wave Caster Leg						\$ 1,631	
TE-5430-BN-WF	Bullnose Edge; Wave Fixed Leg						\$ 1,319	
TE-5430-SQ-ST	Square Edge; Straight Leg						\$ 1,163	
TE-5430-SQ-WC	Square Edge; Wave Caster Leg						\$ 1,531	
TE-5430-SQ-WF	Square Edge; Wave Fixed Leg						\$ 1,219	
	60" Width;	60"	30"	29"	___ Lbs.	___ Cu Ft		There are three different leg styles available:
TE-6030-AC-ST	Acrylic Edge; Straight Leg						\$ 1,006	
TE-6030-AC-WC	Acrylic Edge; Wave Caster Leg						\$ 1,375	
TE-6030-AC-WF	Acrylic Edge; Wave Fixed Leg						\$ 1,063	
TE-6030-BN-ST	Bullnose Edge; Straight Leg						\$ 1,306	
TE-6030-BN-WC	Bullnose Edge; Wave Caster Leg						\$ 1,675	
TE-6030-BN-WF	Bullnose Edge; Wave Fixed Leg						\$ 1,363	
TE-6030-SQ-ST	Square Edge; Straight Leg						\$ 1,200	
TE-6030-SQ-WC	Square Edge; Wave Caster Leg						\$ 1,569	
TE-6030-SQ-WF	Square Edge; Wave Fixed Leg						\$ 1,256	
	72" Width;	72"	30"	29"	___ Lbs.	___ Cu Ft		
TE-7230-AC-ST	Acrylic Edge; Straight Leg						\$ 1,050	
TE-7230-AC-WC	Acrylic Edge; Wave Caster Leg						\$ 1,419	
TE-7230-AC-WF	Acrylic Edge; Wave Fixed Leg						\$ 1,106	
TE-7230-BN-ST	Bullnose Edge; Straight Leg						\$ 1,388	
TE-7230-BN-WC	Bullnose Edge; Wave Caster Leg						\$ 1,756	
TE-7230-BN-WF	Bullnose Edge; Wave Fixed Leg						\$ 1,444	
TE-7230-SQ-ST	Square Edge; Straight Leg						\$ 1,269	
TE-7230-SQ-WC	Square Edge; Wave Caster Leg						\$ 1,638	
TE-7230-SQ-WF	Square Edge; Wave Fixed Leg						\$ 1,325	











MODEL NUMBER	PRODUCT	WIDTH	DEPTH	HEIGHT	WEIGHT	VOLUME	LIST PRICE	DESCRIPTION
	RECTANGLE Computer Station, Leg Base, 36" Depths:							Each table is constructed of a 1" thick top with a plastic laminate top surface.
	42" Width;	42"	36"	29"	___ Lbs.	___ Cu Ft		There are three edge profiles available:
TE-4236-AC-ST	Acrylic Edge; Straight Leg						\$ 969	 <p>Model "AC" Acrylic Edge Model "BN" 3/4" Bullnose Edge Model "SQ" 1/4" Square Edge</p>
TE-4236-AC-WC	Acrylic Edge; Wave Caster Leg						\$ 1,338	
TE-4236-AC-WF	Acrylic Edge; Wave Fixed Leg						\$ 1,025	
TE-4236-BN-ST	Bullnose Edge; Straight Leg						\$ 1,231	
TE-4236-BN-WC	Bullnose Edge; Wave Caster Leg						\$ 1,600	
TE-4236-BN-WF	Bullnose Edge; Wave Fixed Leg						\$ 1,288	
TE-4236-SQ-ST	Square Edge; Straight Leg						\$ 1,138	
TE-4236-SQ-WC	Square Edge; Wave Caster Leg						\$ 1,506	
TE-4236-SQ-WF	Square Edge; Wave Fixed Leg						\$ 1,194	
	48" Width;	48"	36"	29"	___ Lbs.	___ Cu Ft		There are three different leg styles available:
TE-4836-AC-ST	Acrylic Edge; Straight Leg						\$ 994	 <p>Model "ST" Straight 1 1/2" Diameter Leg Model "WF" Wave Fixed Leg Model "WC" Wave Caster Leg</p>
TE-4836-AC-WC	Acrylic Edge; Wave Caster Leg						\$ 1,369	
TE-4836-AC-WF	Acrylic Edge; Wave Fixed Leg						\$ 1,056	
TE-4836-BN-ST	Bullnose Edge; Straight Leg						\$ 1,275	
TE-4836-BN-WC	Bullnose Edge; Wave Caster Leg						\$ 1,644	
TE-4836-BN-WF	Bullnose Edge; Wave Fixed Leg						\$ 1,331	
TE-4836-SQ-ST	Square Edge; Straight Leg						\$ 1,175	
TE-4836-SQ-WC	Square Edge; Wave Caster Leg						\$ 1,544	
TE-4836-SQ-WF	Square Edge; Wave Fixed Leg						\$ 1,231	
	54" Width;	54"	36"	29"	___ Lbs.	___ Cu Ft		
TE-5436-AC-ST	Acrylic Edge; Straight Leg						\$ 1,025	
TE-5436-AC-WC	Acrylic Edge; Wave Caster Leg						\$ 1,394	
TE-5436-AC-WF	Acrylic Edge; Wave Fixed Leg						\$ 1,081	
TE-5436-BN-ST	Bullnose Edge; Straight Leg						\$ 1,319	
TE-5436-BN-WC	Bullnose Edge; Wave Caster Leg						\$ 1,694	
TE-5436-BN-WF	Bullnose Edge; Wave Fixed Leg						\$ 1,381	
TE-5436-SQ-ST	Square Edge; Straight Leg						\$ 1,213	
TE-5436-SQ-WC	Square Edge; Wave Caster Leg						\$ 1,588	
TE-5436-SQ-WF	Square Edge; Wave Fixed Leg						\$ 1,269	



MODEL NUMBER	PRODUCT	WIDTH	DEPTH	HEIGHT	WEIGHT	VOLUME	LIST PRICE	DESCRIPTION	
	RECTANGLE Computer Station, Leg Base, 36" Depths:							Each table is constructed of a 1" thick top with a plastic laminate top surface.	
		60" Width;	60"	36"	29"	___ Lbs.	___ Cu Ft		There are three edge profiles available:
	TE-6036-AC-ST	Acrylic Edge; Straight Leg						\$ 1,050	
	TE-6036-AC-WC	Acrylic Edge; Wave Caster Leg					\$ 1,419		
	TE-6036-AC-WF	Acrylic Edge; Wave Fixed Leg					\$ 1,106		
	TE-6036-BN-ST	Bullnose Edge; Straight Leg					\$ 1,369		
	TE-6036-BN-WC	Bullnose Edge; Wave Caster Leg					\$ 1,738		
	TE-6036-BN-WF	Bullnose Edge; Wave Fixed Leg					\$ 1,425		
	TE-6036-SQ-ST	Square Edge; Straight Leg					\$ 1,256		
	TE-6036-SQ-WC	Square Edge; Wave Caster Leg					\$ 1,625		
TE-6036-SQ-WF	Square Edge; Wave Fixed Leg					\$ 1,313			
	72" Width;	72"	36"	29"	___ Lbs.	___ Cu Ft		There are three different leg styles available:	
TE-7236-AC-ST	Acrylic Edge; Straight Leg						\$ 1,100		
TE-7236-AC-WC	Acrylic Edge; Wave Caster Leg					\$ 1,469			
TE-7236-AC-WF	Acrylic Edge; Wave Fixed Leg					\$ 1,156			
TE-7236-BN-ST	Bullnose Edge; Straight Leg					\$ 1,463			
TE-7236-BN-WC	Bullnose Edge; Wave Caster Leg					\$ 1,831			
TE-7236-BN-WF	Bullnose Edge; Wave Fixed Leg					\$ 1,519			
TE-7236-SQ-ST	Square Edge; Straight Leg					\$ 1,331			
TE-7236-SQ-WC	Square Edge; Wave Caster Leg					\$ 1,700			
TE-7236-SQ-WF	Square Edge; Wave Fixed Leg					\$ 1,388			

MODEL NUMBER	PRODUCT	WIDTH	DEPTH	HEIGHT	WEIGHT	VOLUME	LIST PRICE	DESCRIPTION
	PUZZLE RIGHT, Computer Stations, Leg Base:							Each table is constructed of a 1" thick top with a plastic laminate top surface.
	60" Width;	60"	36"	29"	___ Lbs.	___ Cu Ft		There are three edge profiles available:
TE-PR-6036-AC-ST	Acrylic Edge; Straight Leg						\$ 1,050	
TE-PR-6036-AC-WC	Acrylic Edge; Wave Caster Leg						\$ 1,419	
TE-PR-6036-AC-WF	Acrylic Edge; Wave Fixed Leg						\$ 1,275	
TE-PR-6036-BN-ST	Bullnose Edge; Straight Leg						\$ 1,356	
TE-PR-6036-BN-WC	Bullnose Edge; Wave Caster Leg						\$ 1,725	
TE-PR-6036-BN-WF	Bullnose Edge; Wave Fixed Leg						\$ 1,413	
TE-PR-6036-SQ-ST	Square Edge; Straight Leg						\$ 1,244	
TE-PR-6036-SQ-WC	Square Edge; Wave Caster Leg						\$ 1,619	
TE-PR-6036-SQ-WF	Square Edge; Wave Fixed Leg						\$ 1,225	
	72" Width;	72"	36"	29"	___ Lbs.	___ Cu Ft		There are three different leg styles available:
TE-PR-7236-AC-ST	Acrylic Edge; Straight Leg						\$ 1,100	
TE-PR-7236-AC-WC	Acrylic Edge; Wave Caster Leg						\$ 1,469	
TE-PR-7236-AC-WF	Acrylic Edge; Wave Fixed Leg						\$ 1,156	
TE-PR-7236-BN-ST	Bullnose Edge; Straight Leg						\$ 1,450	
TE-PR-7236-BN-WC	Bullnose Edge; Wave Caster Leg						\$ 1,819	
TE-PR-7236-BN-WF	Bullnose Edge; Wave Fixed Leg						\$ 1,506	
TE-PR-7236-SQ-ST	Square Edge; Straight Leg						\$ 1,325	
TE-PR-7236-SQ-WC	Square Edge; Wave Caster Leg						\$ 1,694	
TE-PR-7236-SQ-WF	Square Edge; Wave Fixed Leg						\$ 1,381	
	PUZZLE LEFT, Computer Stations, Leg Base:							
	60" Width;	60"	36"	29"	___ Lbs.	___ Cu Ft		
TE-PL-6036-AC-ST	Acrylic Edge; Straight Leg						\$ 1,050	
TE-PL-6036-AC-WC	Acrylic Edge; Wave Caster Leg						\$ 1,419	
TE-PL-6036-AC-WF	Acrylic Edge; Wave Fixed Leg						\$ 1,275	
TE-PL-6036-BN-ST	Bullnose Edge; Straight Leg						\$ 1,356	
TE-PL-6036-BN-WC	Bullnose Edge; Wave Caster Leg						\$ 1,725	
TE-PL-6036-BN-WF	Bullnose Edge; Wave Fixed Leg						\$ 1,413	
TE-PL-6036-SQ-ST	Square Edge; Straight Leg						\$ 1,244	
TE-PL-6036-SQ-WC	Square Edge; Wave Caster Leg						\$ 1,619	
TE-PL-6036-SQ-WF	Square Edge; Wave Fixed Leg						\$ 1,225	
	72" Width;	72"	36"	29"	___ Lbs.	___ Cu Ft		
TE-PL-7236-AC-ST	Acrylic Edge; Straight Leg						\$ 1,100	
TE-PL-7236-AC-WC	Acrylic Edge; Wave Caster Leg						\$ 1,469	
TE-PL-7236-AC-WF	Acrylic Edge; Wave Fixed Leg						\$ 1,156	
TE-PL-7236-BN-ST	Bullnose Edge; Straight Leg						\$ 1,450	
TE-PL-7236-BN-WC	Bullnose Edge; Wave Caster Leg						\$ 1,819	
TE-PL-7236-BN-WF	Bullnose Edge; Wave Fixed Leg						\$ 1,506	
TE-PL-7236-SQ-ST	Square Edge; Straight Leg						\$ 1,325	
TE-PL-7236-SQ-WC	Square Edge; Wave Caster Leg						\$ 1,694	
TE-PL-7236-SQ-WF	Square Edge; Wave Fixed Leg						\$ 1,381	

	MODEL NUMBER	PRODUCT	WIDTH	DEPTH	HEIGHT	WEIGHT	VOLUME	LIST PRICE	DESCRIPTION
	TE-PDL-BBF-6030-AC-WC	BBF Pedestal, LEFT Desk: Acrylic Edge; Wave Caster	60"	30"	29"	___ Lbs.	___ Cu Ft	\$ 3,531	<p>Each table is constructed of a 1" thick top with a plastic laminate top surface.</p> <p>There are three edge profiles available:</p>  <p>Model "AC" Acrylic Edge Model "BN" 3/4" Bullnose Edge Model "SQ" 1/4" Square Edge</p> <p>There is one leg styles available:</p>  <p>Model "WC" Wave Caster Leg</p>
	TE-PDL-BBF-6030-BN-WC	Bullnose Edge; Wave Caster						\$ 3,831	
	TE-PDL-BBF-6030-SQ-WC	Square Edge; Wave Caster						\$ 3,725	
	TE-PDL-BBF-7230-AC-WC	Acrylic Edge; Wave Caster	72"	30"	29"	___ Lbs.	___ Cu Ft	\$ 3,581	
	TE-PDL-BBF-7230-BN-WC	Bullnose Edge; Wave Caster						\$ 3,919	
	TE-PDL-BBF-7230-SQ-WC	Square Edge; Wave Caster						\$ 3,794	
	TE-PDR-BBF-6030-AC-WC	BBF Pedestal, RIGHT Desk: Acrylic Edge; Wave Caster	60"	30"	29"	___ Lbs.	___ Cu Ft	\$ 3,531	
	TE-PDR-BBF-6030-BN-WC	Bullnose Edge; Wave Caster						\$ 3,831	
	TE-PDR-BBF-6030-SQ-WC	Square Edge; Wave Caster						\$ 3,725	
	TE-PDR-BBF-7230-AC-WC	Acrylic Edge; Wave Caster	72"	30"	29"	___ Lbs.	___ Cu Ft	\$ 3,581	
	TE-PDR-BBF-7230-BN-WC	Bullnose Edge; Wave Caster						\$ 3,919	
	TE-PDR-BBF-7230-SQ-WC	Square Edge; Wave Caster						\$ 3,794	
	TE-PDL-FF-6030-AC-WC	FF Pedestal, LEFT Desk: Acrylic Edge; Wave Caster	60"	30"	29"	___ Lbs.	___ Cu Ft	\$ 3,525	
	TE-PDL-FF-6030-BN-WC	Bullnose Edge; Wave Caster						\$ 3,825	
	TE-PDL-FF-6030-SQ-WC	Square Edge; Wave Caster						\$ 3,719	
	TE-PDL-FF-7230-AC-WC	Acrylic Edge; Wave Caster	72"	30"	29"	___ Lbs.	___ Cu Ft	\$ 3,569	
	TE-PDL-FF-7230-BN-WC	Bullnose Edge; Wave Caster						\$ 3,913	
	TE-PDL-FF-7230-SQ-WC	Square Edge; Wave Caster						\$ 3,788	
	TE-PDR-FF-6030-AC-WC	FF Pedestal, RIGHT Desk: Acrylic Edge; Wave Caster	60"	30"	29"	___ Lbs.	___ Cu Ft	\$ 3,525	
	TE-PDR-FF-6030-BN-WC	Bullnose Edge; Wave Caster						\$ 3,825	
	TE-PDR-FF-6030-SQ-WC	Square Edge; Wave Caster						\$ 3,719	
	TE-PDR-FF-7230-AC-WC	Acrylic Edge; Wave Caster	72"	30"	29"	___ Lbs.	___ Cu Ft	\$ 3,569	
	TE-PDR-FF-7230-BN-WC	Bullnose Edge; Wave Caster						\$ 3,913	
	TE-PDR-FF-7230-SQ-WC	Square Edge; Wave Caster						\$ 3,788	
	TE-FXB-7230-AC-WC	FF and BBF, Pedestal Desk Acrylic Edge; Wave Caster	72"	30"	29"	___ Lbs.	___ Cu Ft	\$ 5,869	
	TE-FXB-7230-BN-WC	Bullnose Edge; Wave Caster						\$ 6,206	
	TE-FXB-7230-SQ-WC	Square Edge; Wave Caster						\$ 6,088	
	TE-D-BBF-7230-AC-WC	FF and BBF, Pedestal Desk Acrylic Edge; Wave Caster	72"	30"	29"	___ Lbs.	___ Cu Ft	\$ 5,875	
	TE-D-BBF-7230-BN-WC	Bullnose Edge; Wave Caster						\$ 6,219	
	TE-D-BBF-7230-SQ-WC	Square Edge; Wave Caster						\$ 6,094	

	MODEL NUMBER	PRODUCT	WIDTH	DEPTH	HEIGHT	WEIGHT	VOLUME	LIST PRICE	DESCRIPTION
	TE-MS-AV-30	Audio Visual Cart: 2 Adjustable Shelves	36"	18"	30"	___ Lbs.	___ Cu Ft	\$ 2,363	
	TE-MS-AV-30-LD	Audio Visual Cart: 2 Adjustable Shelves, Locking Doors	36"	18"	30"	___ Lbs.	___ Cu Ft	\$ 2,525	
	TE-MS-WR-60	Mobile Wardrobe: Locking Cupboard, 1 File, 4 Adjustable Shelves	36"	24"	60"	___ Lbs.	___ Cu Ft	\$ 2,819	
	TE-MS-WR-72	Mobile Wardrobe: Locking Cupboard, 2 File, 3 Adjustable Shelves	36"	24"	72"	___ Lbs.	___ Cu Ft	\$ 3,075	
	TE-MS-SU-30-A	Mobile Support Unit: Locking Box and File, 2 Adjustable Shelves, Acrylic Screen	36"	24"	30"	___ Lbs.	___ Cu Ft	\$ 2,925	

	MODEL NUMBER	PRODUCT	WIDTH	DEPTH	HEIGHT	WEIGHT	VOLUME	LIST PRICE	DESCRIPTION
	TE-MS-SU-30-B	Mobile Support Unit: Locking Box and File, 2 Pencil, Open Cubbie, Acrylic Screen	36"	24"	30"	___ Lbs.	___ Cu Ft	\$ 3,050	
	TE-MS-S-28	Mobile Shelving: 2 Adjustable Shelves	18"	24"	28"	___ Lbs.	___ Cu Ft	\$ 1,581	
	TE-MS-CB-28	Mobile Cupboard: 2 Adjustable Shelves, Locking Door	18"	24"	28"	___ Lbs.	___ Cu Ft	\$ 1,988	
	TE-MS-BBF-28	Mobile Unit: Locking Pencil, Box, File	18"	24"	28"	___ Lbs.	___ Cu Ft	\$ 2,625	
	TE-MS-FF-28	Mobile Unit: Locking 2 File	18"	24"	28"	___ Lbs.	___ Cu Ft	\$ 2,619	









MODEL NUMBER	PRODUCT	WIDTH	DEPTH	HEIGHT	WEIGHT	VOLUME	LIST PRICE	DESCRIPTION
WAVE II Single Face Carrels:								Carrel units have a 1/2" thick frosted acrylic back. Brushed stainless steel acrylic to post mount hardware.
Single STARTER Units;								Pole extension with courtesy shelf is available as well as optional wood back panels to replace the frost back panel that comes standard with each unit.
	WC2-SS-36MC-AC	Acrylic Edge	38"	32"	29"/37"	__ Lbs.	__ Cu Ft	\$ 2,788
	WC2-SS-36MC-BN	Bullnose Edge						\$ 3,194
	WC2-SS-36MC-MP	Multi-Ply Edge						\$ 2,725
	WC2-SS-48MC-AC	Acrylic Edge	50"	32"	29"/37"	__ Lbs.	__ Cu Ft	\$ 2,994
	WC2-SS-48MC-BN	Bullnose Edge						\$ 3,394
	WC2-SS-48MC-MP	Multi-Ply Edge						\$ 2,925
Single ADDER Units;								There are three edge profiles available:
	WC2-SA-36MC-AC	Acrylic Edge	36 1/2"	32"	29"/37"	__ Lbs.	__ Cu Ft	\$ 2,425
	WC2-SA-36MC-BN	Bullnose Edge						\$ 3,006
	WC2-SA-36MC-MP	Multi-Ply Edge						\$ 2,231
	WC2-SA-48MC-AC	Acrylic Edge	48 1/2"	32"	29"/37"	__ Lbs.	__ Cu Ft	\$ 2,625
	WC2-SA-48MC-BN	Bullnose Edge						\$ 3,206
	WC2-SA-48MC-MP	Multi-Ply Edge						\$ 2,563
2 Place Workstations, (Side By Side);								
	WC2-36W2-AC	Acrylic Edge	74"	32"	29"/37"	__ Lbs.	__ Cu Ft	\$ 5,213
	WC2-36W2-BN	Bullnose Edge						\$ 6,200
	WC2-36W2-MP	Multi-Ply Edge						\$ 4,956
	WC2-48W2-AC	Acrylic Edge	98"	32"	29"/37"	__ Lbs.	__ Cu Ft	\$ 5,619
	WC2-48W2-BN	Bullnose Edge						\$ 6,600
	WC2-48W2-MP	Multi-Ply Edge						\$ 5,488















Model "AC"
Acrylic Edge







Model "BN"
3/4" Bullnose Edge

Model "MP"
Exposed Multi-ply
Core Edge

MODEL NUMBER	PRODUCT	WIDTH	DEPTH	HEIGHT	WEIGHT	VOLUME	LIST PRICE	DESCRIPTION	
WAVE II Single Face Carrels:								Carrel units have a 1/2" thick frosted acrylic back. Brushed stainless steel acrylic to post mount hardware.	
3 Place Workstations, (Side By Side);								Pole extension with courtesy shelf is available as well as optional wood back panels to replace the frost back panel that comes standard with each unit.	
	WC2-36W3-AC	110 1/2"	32"	29"/37"	___ Lbs.	___ Cu Ft	\$ 7,638	There are three edge profiles available:	
	WC2-36W3-BN						\$ 9,206		
	WC2-36W3-MP						\$ 7,188		
	WC2-48W3-AC	146 1/2"	32"	29"/37"	___ Lbs.	___ Cu Ft	\$ 8,244	  	
	WC2-48W3-BN						\$ 9,806		
	WC2-48W3-MP						\$ 8,050		
4 Place Workstations, (Side By Side);									
	WC2-36W4-AC	147"	32"	29"/37"	___ Lbs.	___ Cu Ft	\$ 10,063	Model "AC" Acrylic Edge	
	WC2-36W4-BN						\$ 12,213		Model "BN" 3/4" Bullnose Edge
	WC2-36W4-MP						\$ 9,419		
	WC2-48W4-AC	195"	32"	29"/37"	___ Lbs.	___ Cu Ft	\$ 10,869		
	WC2-48W4-BN						\$ 13,013		
	WC2-48W4-MP						\$ 10,613		
5 Place Workstations, (Side By Side);									
	WC2-36W5-AC	183 1/2"	32"	29"/37"	___ Lbs.	___ Cu Ft	\$ 12,488		
	WC2-36W5-BN						\$ 15,219		
	WC2-36W5-MP						\$ 11,650		
	WC2-48W5-AC	243 1/2"	32"	29"/37"	___ Lbs.	___ Cu Ft	\$ 13,494		
	WC2-48W5-BN						\$ 16,219		
	WC2-48W5-MP						\$ 13,175		

MODEL NUMBER	PRODUCT	WIDTH	DEPTH	HEIGHT	WEIGHT	VOLUME	LIST PRICE	DESCRIPTION
WAVE II Double Face Carrels:								Carrel units have a 1/2" thick frosted acrylic back. Brushed stainless steel acrylic to post mount hardware.
Double STARTER Units;								Pole extension with courtesy shelf is available as well as optional wood back panels to replace the frost back panel that comes standard with each unit.
	WC2-DS36-AC WC2-DS36-BN WC2-DS36-MP	Acrylic Edge Bullnose Edge Multi-Ply Edge	38"	62"	29"/37"	__ Lbs.	__ Cu Ft	\$ 4,344 \$ 5,063 \$ 4,213
	WC2-DS48-AC WC2-DS48-BN WC2-DS48-MP	Acrylic Edge Bullnose Edge Multi-Ply Edge	50"	62"	29"/37"	__ Lbs.	__ Cu Ft	\$ 4,544 \$ 5,263 \$ 4,413
	There are three edge profiles available:							
								  
								Model "AC" Acrylic Edge
								Model "BN" 3/4" Bullnose Edge
								Model "MP" Exposed Multi-ply Core Edge
Double ADDER Units;								
	WC2-DA36-AC WC2-DA36-BN WC2-DA36-MP	Acrylic Edge Bullnose Edge Multi-Ply Edge	36 1/2"	62"	29"/37"	__ Lbs.	__ Cu Ft	\$ 3,863 \$ 4,575 \$ 3,725
	WC2-DA48-AC WC2-DA48-BN WC2-DA48-MP	Acrylic Edge Bullnose Edge Multi-Ply Edge	48 1/2"	62"	29"/37"	__ Lbs.	__ Cu Ft	\$ 4,063 \$ 4,781 \$ 3,931
	4 Place Workstations, (2 Back to Back);							
	WC2-CB36-AC WC2-CB36-BN WC2-CB36-MP	Acrylic Edge Bullnose Edge Multi-Ply Edge	74"	62"	29"/37"	__ Lbs.	__ Cu Ft	\$ 8,206 \$ 9,638 \$ 7,938
	WC2-CB48-AC WC2-CB48-BN WC2-CB48-MP	Acrylic Edge Bullnose Edge Multi-Ply Edge	98"	62"	29"/37"	__ Lbs.	__ Cu Ft	\$ 8,606 \$ 10,044 \$ 8,344

MODEL NUMBER	PRODUCT	WIDTH	DEPTH	HEIGHT	WEIGHT	VOLUME	LIST PRICE	DESCRIPTION
	WAVE II Double Face Carrels:							Carrel units have a 1/2" thick frosted acrylic back. Brushed stainless steel acrylic to post mount hardware.
	6 Place Workstation (3 Back to Back);							Pole extension with courtesy shelf is available as well as optional wood back panels to replace the frost back panel that comes standard with each unit.
	WC2-CC36-AC WC2-CC36-BN WC2-CC36-MP	110 1/2"	62"	29"/37"	___ Lbs.	___ Cu Ft	\$ 12,069 \$ 14,213 \$ 11,663	There are three edge profiles available:   
	WC2-CC48-AC WC2-CC48-BN WC2-CC48-MP	146 1/2"	62"	29"/37"	___ Lbs.	___ Cu Ft	\$ 12,669 \$ 14,825 \$ 12,275	
	WC2-CD36-AC WC2-CD36-BN WC2-CD36-MP	147"	62"	29"/37"	___ Lbs.	___ Cu Ft	\$ 15,931 \$ 18,788 \$ 15,388	Model "AC" Acrylic Edge Model "BN" 3/4" Bullnose Edge Model "MP" Exposed Multi-ply Core Edge
	WC2-CD48-AC WC2-CD48-BN WC2-CD48-MP	195"	62"	29"/37"	___ Lbs.	___ Cu Ft	\$ 16,731 \$ 19,606 \$ 16,206	
	WC2-CE36-AC WC2-CE36-BN WC2-CE36-MP	183 1/2"	62"	29"/37"	___ Lbs.	___ Cu Ft	\$ 19,794 \$ 23,363 \$ 19,113	
	WC2-CE48-AC WC2-CE48-BN WC2-CE48-MP	243 1/2"	62"	29"/37"	___ Lbs.	___ Cu Ft	\$ 20,794 \$ 24,388 \$ 20,138	







MODEL NUMBER	PRODUCT	WIDTH	DEPTH	HEIGHT	WEIGHT	VOLUME	LIST PRICE	DESCRIPTION
WAVE III Single Face Carrels:								Carrel units have a 1" thick veneer back instead of acrylic, with brushed stainless steel posts.
Single STARTER Units;								Pole extension with courtesy shelf option is available for this unit also.
	WC3-SS-36MC-AC	Acrylic Edge	38"	27 3/4"	29"/36"	___ Lbs.	___ Cu Ft	\$ 1,906
	WC3-SS-36MC-BN	Bullnose Edge						\$ 2,306
	WC3-SS-36MC-MP	Multi-Ply Edge						\$ 1,838
	WC3-SS-48MC-AC	Acrylic Edge	50"	27 3/4"	29"/36"	___ Lbs.	___ Cu Ft	\$ 2,106
	WC3-SS-48MC-BN	Bullnose Edge						\$ 2,513
	WC3-SS-48MC-MP	Multi-Ply Edge						\$ 2,044
Single ADDER Units;								There are three edge profiles available:
	WC3-SA-36MC-AC	Acrylic Edge	36 1/2"	27 3/4"	29"/36"	___ Lbs.	___ Cu Ft	\$ 1,538
	WC3-SA-36MC-BN	Bullnose Edge						\$ 2,119
	WC3-SA-36MC-MP	Multi-Ply Edge						\$ 1,475
	WC3-SA-48MC-AC	Acrylic Edge	48 1/2"	27 3/4"	29"/36"	___ Lbs.	___ Cu Ft	\$ 1,744
	WC3-SA-48MC-BN	Bullnose Edge						\$ 2,325
	WC3-SA-48MC-MP	Multi-Ply Edge						\$ 1,675
2 Place Workstations, (Side By Side);								
	WC3-36W2-AC	Acrylic Edge	74"	27 3/4"	29"/36"	___ Lbs.	___ Cu Ft	\$ 3,444
	WC3-36W2-BN	Bullnose Edge						\$ 4,425
	WC3-36W2-MP	Multi-Ply Edge						\$ 3,313
	WC3-48W2-AC	Acrylic Edge	98"	27 3/4"	29"/36"	___ Lbs.	___ Cu Ft	\$ 3,850
	WC3-48W2-BN	Bullnose Edge						\$ 4,838
	WC3-48W2-MP	Multi-Ply Edge						\$ 3,719



Model "AC"
Acrylic Edge









Model "BN"
3/4" Bullnose Edge

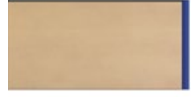





Model "MP"
Exposed Multi-ply
Core Edge





MODEL NUMBER	PRODUCT	WIDTH	DEPTH	HEIGHT	WEIGHT	VOLUME	LIST PRICE	DESCRIPTION
WAVE III Single Face Carrels:								Carrel units have a 1" thick veneer back instead of acrylic, with brushed stainless steel posts.
3 Place Workstations, (Side By Side);								Pole extension with courtesy shelf option is available for this unit also.
	WC3-36W3-AC	110 1/2"	27 3/4"	29"/36"	___ Lbs.	___ Cu Ft	\$ 4,981	
	WC3-36W3-BN						\$ 6,544	
	WC3-36W3-MP						\$ 4,788	
	WC3-48W3-AC	146 1/2"	27 3/4"	29"/36"	___ Lbs.	___ Cu Ft	\$ 5,594	
	WC3-48W3-BN						\$ 7,163	
	WC3-48W3-MP						\$ 5,394	
4 Place Workstations, (Side By Side);								There are three edge profiles available:
	WC3-36W4-AC	147"	27 3/4"	29"/36"	___ Lbs.	___ Cu Ft	\$ 6,519	
	WC3-36W4-BN						\$ 8,663	
	WC3-36W4-MP						\$ 6,263	
	WC3-48W4-AC	195"	27 3/4"	29"/36"	___ Lbs.	___ Cu Ft	\$ 7,338	
	WC3-48W4-BN						\$ 9,488	
	WC3-48W4-MP						\$ 7,069	
5 Place Workstations, (Side By Side);								
	WC3-36W5-AC	183"	27 3/4"	29"/36"	___ Lbs.	___ Cu Ft	\$ 8,056	
	WC3-36W5-BN						\$ 10,781	
	WC3-36W5-MP						\$ 7,738	
	WC3-48W5-AC	243 1/2"	27 3/4"	29"/36"	___ Lbs.	___ Cu Ft	\$ 9,081	
	WC3-48W5-BN						\$ 11,813	
	WC3-48W5-MP						\$ 8,744	













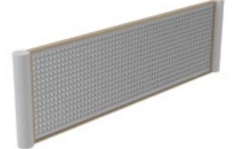

Model "AC" Acrylic Edge Model "BN" 3/4" Bullnose Edge Model "MP" Exposed Multi-ply Core Edge







MODEL NUMBER	PRODUCT	WIDTH	DEPTH	HEIGHT	WEIGHT	VOLUME	LIST PRICE	DESCRIPTION	
	WAVE III Double Face Carrels:							Carrel units have a 1" thick veneer back instead of acrylic, with brushed stainless steel posts.	
	Double STARTER Units;							Pole extension with courtesy shelf option is available for this unit also.	
	WC3-DS36-AC	38"	53 3/4"	29"/36"	___ Lbs.	___ Cu Ft	\$ 3,488	There are three edge profiles available:   	
	WC3-DS36-BN						\$ 4,206		
	WC3-DS36-MP						\$ 3,356		
	WC3-DS48-AC	50"	53 3/4"	29"/36"	___ Lbs.	___ Cu Ft	\$ 3,694		
	WC3-DS48-BN						\$ 4,406		
	WC3-DS48-MP						\$ 3,563		
	Double ADDER Units;								
	WC3-DA36-AC	36 1/2"	53 3/4"	29"/36"	___ Lbs.	___ Cu Ft	\$ 3,000		
	WC3-DA36-BN						\$ 3,719		
	WC3-DA36-MP						\$ 2,869		
	WC3-DA48-AC	48 1/2"	53 3/4"	29"/36"	___ Lbs.	___ Cu Ft	\$ 3,200		
	WC3-DA48-BN						\$ 3,919		
	WC3-DA48-MP						\$ 3,069		
	4 Place Workstations, (2 Back to Back);								
	WC3-CB36-AC	74"	53 3/4"	29"/36"	___ Lbs.	___ Cu Ft	\$ 6,488		
	WC3-CB36-BN						\$ 7,925		
	WC3-CB36-MP						\$ 6,225		
	WC3-CB48-AC	98"	53 3/4"	29"/36"	___ Lbs.	___ Cu Ft	\$ 6,894		
	WC3-CB48-BN						\$ 8,325		
	WC3-CB48-MP						\$ 6,631		

MODEL NUMBER	PRODUCT	WIDTH	DEPTH	HEIGHT	WEIGHT	VOLUME	LIST PRICE	DESCRIPTION
	WAVE III Double Face Carrels:							Carrel units have a 1" thick veneer back instead of acrylic, with brushed stainless steel posts. Pole extension with courtesy shelf option is available for this unit also.
	6 Place Workstation (3 Back to Back);							
WC3-CC36-AC WC3-CC36-BN WC3-CC36-MP	Acrylic Edge Bullnose Edge Multi-Ply Edge	110 1/2"	53 3/4"	29"/36"	___ Lbs.	___ Cu Ft	\$ 9,488 \$ 11,644 \$ 9,094	
WC3-CC48-AC WC3-CC48-BN WC3-CC48-MP	Acrylic Edge Bullnose Edge Multi-Ply Edge	146 1/2"	53 3/4"	29"/36"	___ Lbs.	___ Cu Ft	\$ 10,094 \$ 12,244 \$ 9,700	There are three edge profiles available:
								  
								Model "AC" Acrylic Edge Model "BN" 3/4" Bullnose Edge Model "MP" Exposed Multi-ply Core Edge
	8 Place Workstation (4 Back to Back);							
WC3-CD36-AC WC3-CD36-BN WC3-CD36-MP	Acrylic Edge Bullnose Edge Multi-Ply Edge	147"	53 3/4"	29"/36"	___ Lbs.	___ Cu Ft	\$ 12,488 \$ 15,363 \$ 11,963	
WC3-CD48-AC WC3-CD48-BN WC3-CD48-MP	Acrylic Edge Bullnose Edge Multi-Ply Edge	195"	53 3/4"	29"/36"	___ Lbs.	___ Cu Ft	\$ 13,294 \$ 16,163 \$ 12,769	
	10 Place Workstation (5 Back to Back);							
WC3-CE36-AC WC3-CE36-BN WC3-CE36-MP	Acrylic Edge Bullnose Edge Multi-Ply Edge	183 1/2"	53 3/4"	29"/36"	___ Lbs.	___ Cu Ft	\$ 15,488 \$ 19,081 \$ 14,831	
WC3-CE48-AC WC3-CE48-BN WC3-CE48-MP	Acrylic Edge Bullnose Edge Multi-Ply Edge	243 1/2"	53 3/4"	29"/36"	___ Lbs.	___ Cu Ft	\$ 16,494 \$ 20,081 \$ 15,838	

	MODEL NUMBER	PRODUCT	WIDTH	DEPTH	HEIGHT	WEIGHT	VOLUME	LIST PRICE	DESCRIPTION
	WC-CS-FS	Frosted Acrylic Courtesy Shelf	16"	9"	1/2"	1 Lb.		\$ 338	Note: Pole Extension option is required for Wave Versions II and III, when ordering a Courtesy Shelf.
	WC-CS-FS-1	Frosted Glass Courtesy Shelf				1 Lbs.		\$ 388	
	WC-CS-OAK	Oak Wood Courtesy Shelf				2 Lbs.		\$ 319	
	WC-CS-MAPLE	Maple Wood Courtesy Shelf				2 Lbs.		\$ 319	
	WC-PE	Pole Extension			12"			\$ 238	This Pole Extension option is required when ordering a Courtesy Shelf Option for Wave Versions II and III. NOTE: It must be indicated which Pole on the unit is to be extended. Plan layout required.
	WC-WBO38-OAK	1/2" Oak Wood Back Panel Option in Lieu of Frosted	34 1/2"	1/2"	36"	15 Lbs.		\$ 431	
	WC-WBO50-OAK		46 1/2"	1/2"	36"	22 Lbs.		\$ 450	
	WC-WBO38-MAPLE	1/2" Maple Wood Back Panel Option in Lieu of Frosted	34 1/2"	1/2"	36"	15 Lbs.		\$ 431	
	WC-WBO50-MAPLE		46 1/2"	1/2"	36"	22 Lbs.		\$ 450	

	MODEL NUMBER	PRODUCT	WIDTH	DEPTH	HEIGHT	WEIGHT	VOLUME	LIST PRICE	DESCRIPTION
	S-FA-S	Frosted Acrylic Screen - Small	20"		8"	2.5 Lbs.	0.5 Cu Ft	\$ 331	
	S-FA-L	Frosted Acrylic Screen - Large	32"		8"	2.5 Lbs.	0.5 Cu Ft	\$ 350	
	S-FAS	Frosted Acrylic Screen Surround	32"	13"	8"	9.5 Lbs.	0.5 Cu Ft	\$ 681	
	S-WS	Wood Screen Surround	32"	7"	8"	8 Lbs. 8 Lbs.	0.5 Cu Ft 0.5 Cu Ft	\$ 338	
	S-SWM-S	Wood Frame Perforated Metal Screen - Small	20"		8"			\$ 625	
	S-SWM-L	Wood Frame Perforated Metal Screen - Large	32"		16"			\$ 931	
	S-SWW-S	Wood Screen, Metal Posts - Small	20"		8"			\$ 413	
	S-SWW-L	Wood Screen, Metal Posts - Large	32"		16"			\$ 619	
	S-SWA	Wood Frame, Metal Posts, Frosted Acrylic Screen	24"		16"			\$ 931	

	MODEL NUMBER	PRODUCT	WIDTH	DEPTH	HEIGHT	WEIGHT	VOLUME	LIST PRICE	DESCRIPTION
	PD-BL	Pencil Drawer	20 ⁷ / ₈ "	18 ¹ / ₂ "	1 ⁷ / ₈ "	__ Lbs.	__ Cu Ft	\$ 175	Pencil & paper drawer. Includes roller slides and frame for under-desk mounting. Black finish.
	CD-250-PK	Pullout Keyboard	24"	11"		__ Lbs.	__ Cu Ft	\$ 638	
	CD-250-AK	Articulating Keyboard and Mouse	21"	10"		__ Lbs.	__ Cu Ft	\$ 638	
	PW-G2D	Plastic Grommet 2"	2"	2"	³ / ₄ "	0.1 Lbs.	__ Cu Ft	\$ 106	
	PW-G3D	Plastic Grommet 3"	3"	3"	³ / ₄ "			\$ 106	
	P-TC-V	Vertical Flex Wire Leg	3"	2"	32 ¹ / ₂ "	__ Lbs.	__ Cu Ft	\$ 206	32 ¹ / ₂ " Silver Plastic. Separates wire in different channels for easier maintenance. Kit includes: 1 top bracket, 15 spine wheels, 2 fixing clips for horizontal applications and 1 weighted base. Also comes in Black.
	P-TC	Table Connector	3"	2"		__ Lbs.	__ Cu Ft	\$ 50	
	PW-OWMT-30	Wire Manager	30"	2"		__ Lbs.	__ Cu Ft	\$ 106	

	MODEL NUMBER	PRODUCT	WIDTH	DEPTH	HEIGHT	WEIGHT	VOLUME	LIST PRICE	DESCRIPTION
	PW-100-F	Flip-Up Power - 2 outlet, 2 data	9"		5 1/2"	__ Lbs.	__ Cu Ft	\$ 781	Black Metal
	PW-100-J	Jr. Flip-Up Power - 2 outlet, 2 data	5 3/4"		5 1/2"	__ Lbs.	__ Cu Ft	\$ 631	Black Metal
	DTP-BL	Desktop Power and Data	7"		3"	__ Lbs.	__ Cu Ft	\$ 288	Black Plastic
	P-PS-B	Power Sphere - 4 outlets - Black	3"		3"	__ Lbs.	__ Cu Ft	\$ 344	Black Plastic
	P-PDS-B	Power Sphere - 2 outlets, 2 data - Black	3"		3"	__ Lbs.	__ Cu Ft	\$ 269	
	P-PS-T	Power Sphere - 4 outlets - Translucent	3"		3"	__ Lbs.	__ Cu Ft	\$ 344	Translucent Plastic
	P-PDS-T	Power Sphere - 2 outlets, 2 data - Translucent	3"		3"	__ Lbs.	__ Cu Ft	\$ 269	
	PW-SPC-6	6 Outlet Power Bar	11"		2"	__ Lbs.	__ Cu Ft	\$ 156	White Plastic - 15 amp 120V

Palmieri Furniture Limited ("Palmieri") warrants that its products and collections are free from defects in materials and workmanship for the life of the product, except as set forth below. Palmieri Limited Lifetime Warranty is valid from the date of delivery.

Exceptions to the Limited Lifetime Warranty: Seating: two (2) years

Goods sold hereunder are covered by a Limited Lifetime Warranty, free against defects in material and workmanship provided the goods and services are subjected to normal use and service. The applicable warranty period commences from shipping date to Purchaser of any item of the goods, whichever occurs first, or any other warranty period otherwise stipulated in writing by Palmieri under this sale. For components not supplied by Palmieri, the original manufacturer's warranty shall apply to the extent assignable by Palmieri. The obligation under this warranty is limited to the repair or replacement, at Palmieri's option, of defective parts F.O.B. point of shipment provided that prompt notice of any defect is given by Purchaser to Palmieri in writing within the applicable warranty period and that upon the Purchaser's return of the defective parts to Palmieri or, if designated by Palmieri, to the location where the works are made, properly packed and with transportation charges prepaid by Purchaser, an inspection thereof shall reveal to Palmieri's satisfaction that Purchaser's claim is valid under the terms of this warranty. Purchaser shall assume all responsibility and expense for dismantling, removal, re-installation and freight in connection with the foregoing. The same obligations and conditions extend to replacement parts furnished by Palmieri hereunder.

Palmieri does not assume liability for installation, labour or consequential damages. Palmieri makes no warranty other than the one set forth herein. All other warranties, legal, expressed or implied, including but not limited to any expressed or implied warranty of merchantability, of fitness for the intended use thereof or against infringement are hereby expressly excluded. The applicable warranty ceases to be effective if the goods are altered or repaired other than by persons authorized or approved by Palmieri to perform such work. Repairs or replacement deliveries do not interrupt or prolong the term of the warranty. The warranty ceases to be effective if Purchaser fails to handle and use the goods sold hereunder in a safe and reasonable manner and in accordance with any written instructions from the manufacturers.

Warranty Does Not Apply To Product Failure Or Loss Resulting From:

Abuse, misuse or accident, alteration or modification of product by customer or third party, normal wear and tear, improper installation, handling or incorrect use. The substitution of part components or hardware not approved or authorized by Palmieri, acts of God, unauthorized repairs, improper storage, and environmental conditions such as irregular temperature control either inside or outside the environment.

Warranty Provides Exclusive Remedies:

If a product fails under ordinary use as a result of a defect in material or workmanship, Palmieri will: (A) repair, or (B) replace the furniture. The replacement or repair of the Furniture or Seating will be at the discretion of Palmieri. If the defect or workmanship cannot be remedied on site, repairs can be made at the factory. (C) If the product repair or replacement is not commercially practicable or cannot be remade in a timely manner Palmieri will refund the purchase price of the affected product. A product "**Defect**" means: an inadequacy in the materials or workmanship of the product that (A) existed at the time when you received the product from Palmieri or Palmieri authorized Reseller and (B) causes a failure of the product to perform under ordinary use in accordance with the materials and documentation accompanying the product. "**Ordinary Use**" means: use of the product (A) in accordance with all applicable local, state or federal laws, codes and regulations and (B) in accordance with manufacturer recommendations and or instructions in the materials and documentation accompanying the product or through shop drawings. A "**Palmieri Authorized Reseller**" means: any dealer that is legally permitted to conduct business in the jurisdiction where the product is sold and is duly authorized by Palmieri to sell the product.

Warranty work must be approved by authorized personnel of Palmieri Furniture Limited in Richmond Hill, Ontario, Canada.

A copy of the original purchase order must accompany all claims.

Warranty Does Not Cover:

Matching of colours, stains, textures, grains and any other variations in materials. Select and Custom Surfaces and materials are only warranted for their application on the specified product and are not covered by our warranty, except as warranted by the original supplier, for quality, colorfastness, shade variations or abrasion and textiles purchased for Palmieri product.

This limited warranty is the sole remedy for product defect and no other express or implied warranty is provided. Warranty is not transferable and valid only for the original purchaser acquiring a product from Palmieri or a Palmieri authorized reseller for the purchaser's own use and not for resale, remarketing or distribution. Limited Lifetime Warranty (25 years)

GENERAL

The following Terms and Conditions of Quote and Sale shall apply to any sale of goods and services by Palmieri Furniture Limited (hereinafter called "Palmieri"). Purchaser shall be deemed to have full knowledge of the terms and conditions herein and such terms and conditions shall be binding if either the goods and services referred to herein are delivered to and accepted by Purchaser, or if Purchaser does not within five (5) days from the date hereof deliver to Palmieri written objection to said terms and conditions or any part thereof.

In the event of any conflict or inconsistency between the terms and conditions of sale herein and the terms and conditions contained in Purchaser's order or in any other form issued by Purchaser, whether or not any such form has been acknowledged or accepted by Palmieri, Palmieri's terms and conditions herein shall prevail. No waiver, alteration or modification of these terms and conditions shall be binding upon Palmieri unless made in writing and signed by a duly authorized representative of Palmieri.

1. QUOTATIONS / PRODUCT QUOTED

Unless otherwise stated, **Palmieri's quotations shall be null and void unless accepted by Purchaser within thirty (30) days from the date of quotation.** Quotes may be subject to change before order placement, due to increased material costs and or other factors that could impact the final cost of production and our final understanding of the product required. If the items quoted do not reflect the intended product requirements of the customer, Palmieri will not be held responsible for increased costs for those product changes. We reserve the right to edit or re-quote any portion of a previously submitted quotation subject to our final understanding of the product required by the client.

2. PALMIERI DRAWINGS

Palmieri provides drawings for Custom & Standard product we produce to our clients upon request. We consider these drawings to be Private and Confidential and are provided for the sole purpose and use of our clients to understand the product we are providing. The use of these confidential materials is limited to the transaction between the parties and at no point are these confidential materials to be sent to any of our competitors or parties quoting for the same purpose.

A minimum \$85.00 NET Engineering Administrative Fee will apply for Custom Product Drawings

(Note: The first set of Custom product drawings will be free of charge)

A minimum \$120.00 NET Engineering Administrative Fee will apply for all Standard Product Drawings

3. TERMS OF PAYMENT

For authorized customers; Orders at a \$75,000.00 threshold will require a mandatory 25% deposit. Orders over and above \$100,000.00 requires a mandatory (25%) deposit at time of order, a mandatory (25%) deposit prior to product shipment and the balance to be paid within thirty (30) days of date of shipment. Payment not be made to Palmieri when due, Palmieri reserves the right to charge Purchaser with interest on such overdue payments. Interest of 2% per month (24% per annum) is charged on all overdue accounts, unless otherwise specified. The charging of such interest shall not be construed as obligating Palmieri to grant any extension of time in the terms of payment. All goods remain the property of Palmieri, until balance is paid in full to Palmieri.

4. TITLE

Title to the goods or any part thereof shall not pass from Palmieri to Purchaser until all payments due hereunder have been duly made, except as otherwise expressly stipulated herein. The goods shall be and remain personal or moveable property, notwithstanding their mode of attachment to realty or other property. If default is made in any of the payments herein, Purchaser agrees that Palmieri may retain all payments which have been made on account of the purchase price as liquidated damages, and Palmieri shall be free to enter the premises where the goods may be located and remove them as Palmieri's property, without prejudice to Palmieri's right to recover any further expenses or damages Palmieri may suffer by reason of such nonpayment.

5. TAXES

Prices do not include Goods & Services Tax, Provincial or Municipal sales, use, value-added or similar tax. All applicable taxes are extra. Our Harmonized Sales Tax (HST) registration number is R104055066.

6. THE AGREEMENT

An acceptance and official confirmation of Purchasers' order by signing Palmieri's Order Confirmation the Purchaser therefore is accepting terms and conditions as expressed herein Palmieri's Terms and Conditions of Quote and Sale by Palmieri and shall constitute the complete agreement, subject to the terms and conditions of sale herein set forth, and shall supersede all previous quotations, orders or agreements.

7. LEAD TIME / DELIVERY / DELAYS

Lead time is determined only when final material/finish selection and drawing approvals are received by Palmieri from the client. The accuracy of Palmieri's lead times, is created to the best of our ability with the information provided to us. Confirmed lead time is conveyed to the client by means of Order Confirmation. They do not preclude the client from checking the accuracy of your requirement and our Order Confirmation. Any noted discrepancies are to be reported immediately to Palmieri Customer Service Department for correction and re-issue of revised Order Confirmation. By signing and dating the Order Confirmation the client accepts the terms and conditions of quote and sale.

Lead time on our Order Confirmation do not account for delays that could potentially occur for special materials specified by the client that are outside of our standard finishes and materials program that are out of our control

and will affect the lead time on the order. Palmieri will notify the client immediately when these delays occur and adjust the lead time accordingly.

Delivery schedules are approximate and are based on prevailing market conditions applicable respectively at the time of Palmieri's quotation and Palmieri's acceptance of clients' order, if certain portions of an order are completed by the quoted lead time while other portions have experienced delays outside of our control. The client may choose to part ship the order at their discretion and expense. Otherwise the entire order will ship with the delayed portion at a later date. Palmieri may extend delivery schedules or may, at its option, cancel Purchaser's order in full or in part without liability other than to return any deposit or prepayment which is unearned by reason of the cancellation.

8. CHANGES AND CANCELLATION

Orders accepted by Palmieri are not subject to changes or cancellation by Purchaser without the written consent of Palmieri. In such cases where Palmieri authorizes changes or cancellation, Palmieri reserves the right to charge the Purchaser with reasonable costs based upon expenses already incurred and commitments made by Palmieri, including, without limitation, any labour done, material purchased and also including Supplier's usual overhead and reasonable profit and cancellation charges from Palmieri's suppliers. Palmieri will communicate to the Purchaser additional costs incurred by way of Revised Order Confirmation. Revised Order Confirmation will include applicable costs incurred and modification to lead times (if applicable). The Purchaser must provide Palmieri written confirmation of additional costs, before any changes can be processed on the order.

A minimum charge of \$100.00 NET Change Order Request fee will apply

A minimum charge of \$150.00 NET Cancel Order Request fee will apply.

9. SHIPPING LOCATION / SHIPPING QUOTES / COST OF TRANSPORTATION

Unless otherwise stated, all prices are F.O.B. our factory in Richmond Hill, Ontario, Canada.

Customary methods of transportation shall be selected by Palmieri and such transportation will be at Purchaser's expense. Shipping quotations are made at time of furniture quotation and are outside the control of Palmieri. **Shipping quotes are valid for ten (10) business days from the time of quote.** We do our best to maintain shipping costs as quoted, however all shipping weights and cubic feet shown are approximate only, various construction materials and packaging methods may add to the weights given. All quoted prices, unless otherwise stated on the quotation, are based on the current exchange rates, tariffs, fuel surcharges and costs of manufacture and are subject to change by Palmieri with or without notice until Purchaser's acceptance. Palmieri does not assume responsibility or liability for shipping costs, product during transit, or variances from the shipping weights or cubic feet shown in our specification guides. Special methods of transportation will be used upon Purchaser's request and at Purchaser's additional expense, provided reasonable notice of Purchaser's transportation requirements are given by Purchaser to Palmieri prior to shipment. Palmieri will notify the client prior to shipping product if shipping costs as quoted change, at which point the client must approve the adjusted shipping costs.

10. RECEIVING PRODUCT / REPORTING DAMAGE / STORAGE OF PRODUCT

Upon receipt of Palmieri product, the receiver of the goods must immediately inspect the product to ensure it is free of shipping damage. If the product is deemed in good order, the receiver of the product must ensure

to sign off on the accompanying carriers Bill of lading in good condition. Except for obligations stated under "Warranty" herein, Palmieri's responsibility for the product ceases once the product has been received and signed off in good order and is the full responsibility of the receiver and subsequently the owner.

In the event shipping damage is discovered during receipt of shipment, it is the responsibility of the receiver to ensure all noted damage is recorded on the carrier's Bill of Lading prior to sign off. All noted shipping damage claims must be reported to Palmieri within **24 hours** of receipt of the product onsite, failure to do so will result in the claim being deemed null and void. All shipping damage claims are to be reported directly to Palmieri's Shipping Manager. Please call our toll free number at **1-800-413-4440 ext. 33** or submit the claim by Fax directly to **1-905-731-9878**. Palmieri will not accept any shipping damage claims submitted **after 24 hours** and it shall be conclusively presumed that the goods were delivered in good condition.

Storage of product, Palmieri will not be held responsible for any potential damages or shortages for product shipped and received by Purchaser and is subsequently placed into storage and not inspected within 24 hours of receipt.

11. INSTALLATION / SHORTAGES / BACK CHARGES

Unless otherwise expressly stipulated, the goods shall be installed by and at the risk and expense of Purchaser.

In the event that Palmieri is requested to supervise such installation, Palmieri's responsibility shall be limited to exercising that degree of skill customary in the trade in supervising installations of the same type. Purchaser shall remain responsible for all other aspects of the work including compliance with the local regulations. It is the responsibility of the Purchaser to ensure hardware and parts are received in good order. Packing slip and hardware list to be provided by Palmieri with every order at time of shipping. Purchaser has the responsibility to notify Palmieri immediately without delay of issues that arise; subsequently Palmieri will take action to provide prompt resolution.

Shortages must be reported to Palmieri within **24 hours** of receipt of the goods and failure to do so may be at the expense of the Purchaser.

If deemed missing hardware and parts short shipped from the factory, Palmieri will arrange to ship freight prepaid to destination. Palmieri will only be responsible for replacement costs of missing hardware and parts, any labour costs incurred will be the responsibility of the Purchaser and will not be approved by Palmieri.

Back Charges will only be approved if we deemed a defect in the material or workmanship is found during the installation period resulting in a return trip to the job-site to complete installation. It shall remain the sole discretion of Palmieri to approve (A) repair or (B) replace the furniture and any labour costs incurred by the Purchaser.

12. FORCE MAJEURE

Palmieri shall not be responsible or liable for any loss or damage incurred by Purchaser herein resulting from causes beyond the reasonable control of Palmieri including, but without limitation, abuse, misuse or accident, alteration or modification of product by customer or third party, normal wear and tear, improper installation, handling or incorrect use, unauthorized repairs, the substitution of part components or hardware not approved or authorized by Palmieri, improper storage, and environmental conditions such as irregular temperature control

either inside or outside the environment, acts of God, fire, flood, delays in transportation, or the failure of Palmieri's suppliers to meet their delivery promises. The acceptance of delivery of the goods by Purchaser shall constitute a waiver of all claims for loss or damage due to any delay whatsoever.

13. RETURNED GOODS

No goods may be returned to Palmieri for a credit or exchanged without Palmieri's prior written consent.

Palmieri reserves the right to accept all returns and subject to a handling/restocking charge or to decline all returns. Even after Palmieri has authorized the return of goods for credit, Palmieri reserves the right to adjust the amount of any credit given to Purchaser on return of the goods based on the conditions of the goods on arrival in Palmieri's warehouse. Credit for returned goods will be issued to Purchaser only where such goods are returned by Purchaser and not by any subsequent owner of the goods. Goods will be considered for return only if they are in their original condition and packaging. Palmieri Goods Return Authorization Form to be issued and **must** accompany all shipments returning back to the factory. **Return freight must be prepaid by Purchaser. A minimum 20% re-stocking fee will apply.**

1230 Reid Street
Richmond Hill
Ontario Canada
L4B 1C4

T 905 731 9300
F 905 731 9878
TF 800 413 4440

info@palmierifurniture.com
www.PalmieriFurniture.com

SPECIFICATION GUIDE & PRICE LIST

2017

PALMIER

SHELVING

DURECON METAL

CATEGORY: LIBRARY FURNITURE

CONTRACT: BID #ESCNJ 17/18-16

Introduction	1
Table of Contents	2-7
Product Materials & Finishes	8-11

Durecon Metal Shelving 12-163

Single Face Shelving 12-19



Durecon Shelving is available Single Face and Double Face in heights from 30" to 96", each with widths of 24", 30" and 36".

Double Face Shelving 20-27



Durecon Shelving is available Single Face and Double Face in heights from 30" to 96", each with widths of 24", 30" and 36".

Single Face Shelving – Plastic Laminate Top 28-31



Individual shelving tops have a .050" thick plastic laminate sheet, the underside complete with a .020" thick backer sheet. Suitable for shelving up to 60" Height ONLY

Double Face Shelving – Plastic Laminate Top 32-35



Individual shelving tops have a .050" thick plastic laminate sheet, the underside complete with a .020" thick backer sheet. Suitable for shelving up to 60" Height ONLY

Single Face Shelving – Wood/Glass Doors 36-43



Frame made of 3/4" Thick Solid Hardwood. Vertical stiles will be 3/4" thick x 2 1/2" wide, top stile 2 1/2" wide and bottom 3 1/4" wide tempered glass. Complete with locks and door pulls. **Actual depth of shelves will decrease by 1".

Double Face Shelving – Wood/Glass Doors 44-51



Frame made of 3/4" Thick Solid Hardwood. Vertical stiles will be 3/4" thick x 2 1/2" wide, top stile 2 1/2" wide and bottom 3 1/4" wide tempered glass. Complete with locks and door pulls. **Actual depth of shelves will decrease by 1".

Single Face Shelving – Wood Doors 52-59



Constructed from 3/4" veneer plywood, edges to be banded with 1/4" external hardwood edge. 1" Chrome piano hinges with magnetic touch latch. Complete with locks and door pulls. **Overall depth of shelves will decrease by 1". Please specify with a layout which bay of shelving will receive doors.

Double Face Shelving – Wood Doors 60-67



Constructed from 3/4" veneer plywood, edges to be banded with 1/4" external hardwood edge. 1" Chrome piano hinges with magnetic touch latch. Complete with locks and door pulls. **Overall depth of shelves will decrease by 1". Please specify with a layout which bay of shelving will receive doors.

Single Face Shelving – Sliding Glass Doors 68-75



1/4" Thick tempered glass doors. Shelving fitted with aluminum roller tracks, on bottoms and tops. Each door has a finger pull and case lock. Unit complete with locks. **Overall depth will increase by 2 1/4". Please specify with a layout which bay of shelving will receive doors.

Double Face Shelving – Sliding Glass Doors 76-83



1/4" Thick tempered glass doors. Shelving fitted with aluminum roller tracks, on bottoms and tops. Each door has a finger pull and case lock. Unit complete with locks. **Overall depth will increase by 2 1/4". Please specify with a layout which bay of shelving will receive doors.

Single Face Shelving – Low Back Shelving 84-91



Single Face Shelving – Low Back Shelving 84-91

Double Face Shelving – Low Back Shelving 92-99







Double Face Shelving – Low Back Shelving 92-99







Single Face Shelving – Low Back Shelving, Plastic Laminate Top 100-103















Single Face Shelving – Low Back Shelving, Plastic Laminate Top 100-103

SHELVING

	Double Face Shelving – Low Back Shelving, Plastic Laminate Top	104-107
	Single Face Shelving – Slotted Metal Shelving without Back	108-115
	Double Face Shelving – Slotted Metal Shelving without Back	116-123
	Single Face Shelving – Slotted Metal Shelving without Back, Plastic Laminate Top	124-127
	Double Face Shelving – Slotted Metal Shelving without Back, Plastic Laminate Top	128-131
	Single Face Shelving – Slotted Metal Shelving	132-139
	Double Face Shelving – Slotted Metal Shelving	140-147
	Single Face Shelving – Slotted Metal Shelving, Plastic Laminate Top	148-151
	Double Face Shelving – Slotted Metal Shelving, Plastic Laminate Top	152-155

	Single Face Shelving – Magazine Shelving Durecon Magazine Shelving is available Single Face and Double Face in heights from 30" to 72", each with widths of 24", 30" and 36".	156-157
	Double Face Shelving – Magazine Shelving Durecon Magazine Shelving is available Single Face and Double Face in heights from 30" to 72", each with widths of 24", 30" and 36".	158-159
	Single Face Shelving – Magazine Shelving, Plastic Laminate Top Durecon Magazine Shelving is available Single Face and Double Face in heights from 30" to 72", each with widths of 24", 30" and 36". Individual shelving tops have a .050" thick plastic laminate sheet, the underside complete with a .020" thick backer sheet. Suitable for shelving up to 60" Height ONLY	160-161
	Double Face Shelving – Magazine Shelving, Plastic Laminate Top Durecon Magazine Shelving is available Single Face and Double Face in heights from 30" to 72", each with widths of 24", 30" and 36". Individual shelving tops have a .050" thick plastic laminate sheet, the underside complete with a .020" thick backer sheet. Suitable for shelving up to 60" Height ONLY	162-163
	Components	164-173
	Bolt Assembly End Panels	164-165
	Bolt Assembly Mid Panels	166-167
	Bolt Assembly Shelves	168-169

Components	164-173		
 Printed Backs – Single Face	170-171		Finished Back Cork Option 182-183
 Printed Backs – Double Face	172-173		Finished Back Slotwall Option 184-185
Options & Accessories	174-195		
 Sloped Continuous Plastic Laminate Tops	174-175		Shelves 186-189
 Veneer Backs - Single Face	176-177		Filler Panels 190-191
 Veneer Backs - Double Face	176-177		Mobile Shelving, Multi Bin Shelf, Pull-Out Media Drawer, Fixed Media Drawer, Sway Brace 192-193
 Finished Back Veneer Option	180-181		Metal Book End, Hanging Kick Bag Rod, Wall Mounted Newspaper Rack, Newspaper Stick 194-195
		Warranty	196
		Terms & Conditions	197

METAL PAINT:

Thermal Paint Colours



White
PS-111-W374



Antique White
W11

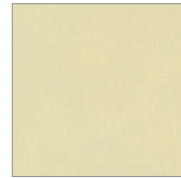

Beige
H23

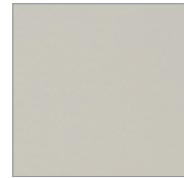

Desert
H432



Red
R66



Ruby
R7



Blue
B11



Navy
B17

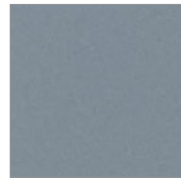

Zinc
A67



Hydro Green
G96



Green
G58



Grey
A16



Charcoal
A230



Black
N49



Pebble
M237

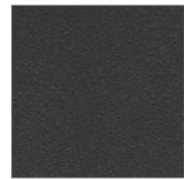

Black Sandtex
N31



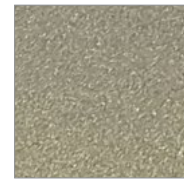

Sparkling Silver
S11



Champagne
S14

METAL FINISHING PROCEDURES: All metal components are thoroughly cleaned and coated electrostatically with an epoxy powder coat paint finish. The metal components are then oven baked and cured for a lasting finish.

SHELVING

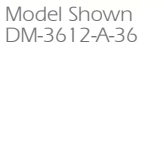
	MODEL NUMBER	PRODUCT	WIDTH	DEPTH	HEIGHT	SHELF DEPTH	# OF SHELVES	# OF OPENINGS	WEIGHT	VOLUME	LIST PRICE	DESCRIPTION
	DM-3010-S-24	Single Face Starter	25 1/4"	10 1/8"	30"	9 1/2"	1	2			\$ 1,094	End, Mid, Top and Base Panels to be constructed from 1" thick 11-ply solid core, veneered 2 sides. Vertical, top and bottom edges banded with 1/4" external hardwood edging, edges to be eased. Front Edge: 3/4" thick x 2 1/2" high fascia - tongue and grooved to top.
	DM-3010-A-24	Single Face Adder	24 1/4"	10 1/8"	30"	9 1/2"	1	2			\$ 750	
	DM-3012-S-24	Single Face Starter	25 1/4"	12 1/8"	30"	11 1/2"	1	2			\$ 1,119	
	DM-3012-A-24	Single Face Adder	24 1/4"	12 1/8"	30"	11 1/2"	1	2			\$ 769	
	DM-3010-S-30	Single Face Starter	31 1/4"	10 1/8"	30"	9 1/2"	1	2			\$ 1,094	
	DM-3010-A-30	Single Face Adder	30 1/4"	10 1/8"	30"	9 1/2"	1	2			\$ 750	
	DM-3012-S-30	Single Face Starter	31 1/4"	12 1/8"	30"	11 1/2"	1	2			\$ 1,120	
	DM-3012-A-30	Single Face Adder	30 1/4"	12 1/8"	30"	11 1/2"	1	2			\$ 769	
	DM-3010-S-36	Single Face Starter	37 1/4"	10 1/8"	30"	9 1/2"	1	2			\$ 938	
	DM-3010-A-36	Single Face Adder	36 1/4"	10 1/8"	30"	9 1/2"	1	2			\$ 600	
	DM-3012-S-36	Single Face Starter	37 1/4"	12 1/8"	30"	11 1/2"	1	2			\$ 969	
	DM-3012-A-36	Single Face Adder	36 1/4"	12 1/8"	30"	11 1/2"	1	2			\$ 613	
	DM-3610-S-24	Single Face Starter	25 1/4"	10 1/8"	36"	9 1/2"	1	2			\$ 1,094	
	DM-3610-A-24	Single Face Adder	24 1/4"	10 1/8"	36"	9 1/2"	1	2			\$ 781	
	DM-3612-S-24	Single Face Starter	25 1/4"	12 1/8"	36"	11 1/2"	1	2			\$ 1,131	
	DM-3612-A-24	Single Face Adder	24 1/4"	12 1/8"	36"	11 1/2"	1	2			\$ 806	
	DM-3610-S-30	Single Face Starter	31 1/4"	10 1/8"	36"	9 1/2"	1	2			\$ 1,094	
	DM-3610-A-30	Single Face Adder	30 1/4"	10 1/8"	36"	9 1/2"	1	2			\$ 781	
	DM-3612-S-30	Single Face Starter	31 1/4"	12 1/8"	36"	11 1/2"	1	2			\$ 1,131	
	DM-3612-A-30	Single Face Adder	30 1/4"	12 1/8"	36"	11 1/2"	1	2			\$ 806	
	DM-3610-S-36	Single Face Starter	37 1/4"	10 1/8"	36"	9 1/2"	1	2	50.6 Lbs.	4 Cu Ft	\$ 938	
	DM-3610-A-36	Single Face Adder	36 1/4"	10 1/8"	36"	9 1/2"	1	2	46 Lbs.	4 Cu Ft	\$ 625	
	DM-3612-S-36	Single Face Starter	37 1/4"	12 1/8"	36"	11 1/2"	1	2	50.6 Lbs.	5 Cu Ft	\$ 981	
	DM-3612-A-36	Single Face Adder	36 1/4"	12 1/8"	36"	11 1/2"	1	2	47.2 Lbs.	5 Cu Ft	\$ 656	

SHELVING

MODEL NUMBER	PRODUCT	WIDTH	DEPTH	HEIGHT	SHELF DEPTH	# OF SHELVES	# OF OPENINGS	WEIGHT	VOLUME	LIST PRICE	DESCRIPTION
DM-4210-S-24	Single Face Starter	25 1/4"	10 1/8"	42"	9 1/2"	2	3			\$ 1,163	End, Mid, Top and Base Panels to be constructed from 1" thick 11-ply solid core, veneered 2 sides. Vertical, top and bottom edges banded with 1/4" external hardwood edging, edges to be eased. Front Edge: 3/4" thick x 2 1/2" high fascia - tongue and grooved to top.
DM-4210-A-24	Single Face Adder	24 1/4"	10 1/8"	42"	9 1/2"	2	3			\$ 856	
DM-4212-S-24	Single Face Starter	25 1/4"	12 1/8"	42"	11 1/2"	2	3			\$ 1,206	
DM-4212-A-24	Single Face Adder	24 1/4"	12 1/8"	42"	11 1/2"	2	3			\$ 881	
DM-4210-S-30	Single Face Starter	31 1/4"	10 1/8"	42"	9 1/2"	2	3			\$ 1,163	
DM-4210-A-30	Single Face Adder	30 1/4"	10 1/8"	42"	9 1/2"	2	3			\$ 856	
DM-4212-S-30	Single Face Starter	31 1/4"	12 1/8"	42"	11 1/2"	2	3			\$ 1,206	
DM-4212-A-30	Single Face Adder	30 1/4"	12 1/8"	42"	11 1/2"	2	3			\$ 881	
DM-4210-S-36	Single Face Starter	37 1/4"	10 1/8"	42"	9 1/2"	2	3	55 Lbs.	5 Cu Ft	\$ 1,013	
DM-4210-A-36	Single Face Adder	36 1/4"	10 1/8"	42"	9 1/2"	2	3	52 Lbs.	5 Cu Ft	\$ 706	
DM-4212-S-36	Single Face Starter	37 1/4"	12 1/8"	42"	11 1/2"	2	3	60 Lbs.	5 Cu Ft	\$ 1,056	
DM-4212-A-36	Single Face Adder	36 1/4"	12 1/8"	42"	11 1/2"	2	3	53 Lbs.	5 Cu Ft	\$ 725	
DM-4810-S-24	Single Face Starter	25 1/4"	10 1/8"	48"	9 1/2"	2	3			\$ 1,188	
DM-4810-A-24	Single Face Adder	24 1/4"	10 1/8"	48"	9 1/2"	2	3			\$ 869	
DM-4812-S-24	Single Face Starter	25 1/4"	12 1/8"	48"	11 1/2"	2	3			\$ 1,225	
DM-4812-A-24	Single Face Adder	24 1/4"	12 1/8"	48"	11 1/2"	2	3			\$ 881	
DM-4810-S-30	Single Face Starter	31 1/4"	10 1/8"	48"	9 1/2"	2	3			\$ 1,188	
DM-4810-A-30	Single Face Adder	30 1/4"	10 1/8"	48"	9 1/2"	2	3			\$ 869	
DM-4812-S-30	Single Face Starter	31 1/4"	12 1/8"	48"	11 1/2"	2	3			\$ 1,225	
DM-4812-A-30	Single Face Adder	30 1/4"	12 1/8"	48"	11 1/2"	2	3			\$ 881	
DM-4810-S-36	Single Face Starter	37 1/4"	10 1/8"	48"	9 1/2"	2	3	74.8 Lbs.	5 Cu Ft	\$ 1,038	
DM-4810-A-36	Single Face Adder	36 1/4"	10 1/8"	48"	9 1/2"	2	3	65.5 Lbs.	5 Cu Ft	\$ 719	
DM-4812-S-36	Single Face Starter	37 1/4"	12 1/8"	48"	11 1/2"	2	3	82.8 Lbs.	6 Cu Ft	\$ 1,075	
DM-4812-A-36	Single Face Adder	36 1/4"	12 1/8"	48"	11 1/2"	2	3	71.3 Lbs.	6 Cu Ft	\$ 731	



Model Shown
DM-4212-S-36



Model Shown
DM-4212-A-36

SHELVING

MODEL NUMBER	PRODUCT	WIDTH	DEPTH	HEIGHT	SHELF DEPTH	# OF SHELVES	# OF OPENINGS	WEIGHT	VOLUME	LIST PRICE	DESCRIPTION
--------------	---------	-------	-------	--------	-------------	--------------	---------------	--------	--------	------------	-------------



Model Shown
DM-6012-S-36



Model Shown
DM-6012-A-36

DM-6010-S-24	Single Face Starter	25 1/4"	10 1/8"	60"	9 1/2"	3	4			\$ 1,238	End, Mid, Top and Base Panels to be constructed from 1" thick 11-ply solid core, veneered 2 sides. Vertical, top and bottom edges banded with 1/4" external hardwood edging, edges to be eased. Front Edge: 3/4" thick x 2 1/2" high fascia - tongue and grooved to top.
DM-6010-A-24	Single Face Adder	24 1/4"	10 1/8"	60"	9 1/2"	3	4			\$ 925	
DM-6012-S-24	Single Face Starter	25 1/4"	12 1/8"	60"	11 1/2"	3	4			\$ 1,269	
DM-6012-A-24	Single Face Adder	24 1/4"	12 1/8"	60"	11 1/2"	3	4			\$ 956	
DM-6010-S-30	Single Face Starter	31 1/4"	10 1/8"	60"	9 1/2"	3	4			\$ 1,238	
DM-6010-A-30	Single Face Adder	30 1/4"	10 1/8"	60"	9 1/2"	3	4			\$ 925	
DM-6012-S-30	Single Face Starter	31 1/4"	12 1/8"	60"	11 1/2"	3	4			\$ 1,269	
DM-6012-A-30	Single Face Adder	30 1/4"	12 1/8"	60"	11 1/2"	3	4			\$ 956	
DM-6010-S-36	Single Face Starter	37 1/4"	10 1/8"	60"	9 1/2"	3	4	100 Lbs.	6 Cu Ft	\$ 1,088	
DM-6010-A-36	Single Face Adder	36 1/4"	10 1/8"	60"	9 1/2"	3	4	86.3 Lbs.	6 Cu Ft	\$ 775	
DM-6012-S-36	Single Face Starter	37 1/4"	12 1/8"	60"	11 1/2"	3	4	116 Lbs.	8 Cu Ft	\$ 1,119	
DM-6012-A-36	Single Face Adder	36 1/4"	12 1/8"	60"	11 1/2"	3	4	95.5 Lbs.	7 Cu Ft	\$ 794	



DM-7210-S-24	Single Face Starter	25 1/4"	10 1/8"	72"	9 1/2"	4	5			\$ 1,313	End, Mid, Top and Base Panels to be constructed from 1" thick 11-ply solid core, veneered 2 sides. Vertical, top and bottom edges banded with 1/4" external hardwood edging, edges to be eased. Front Edge: 3/4" thick x 2 1/2" high fascia - tongue and grooved to top.
DM-7210-A-24	Single Face Adder	24 1/4"	10 1/8"	72"	9 1/2"	4	5			\$ 994	
DM-7212-S-24	Single Face Starter	25 1/4"	12 1/8"	72"	11 1/2"	4	5			\$ 1,350	
DM-7212-A-24	Single Face Adder	24 1/4"	12 1/8"	72"	11 1/2"	4	5			\$ 1,025	
DM-7210-S-30	Single Face Starter	31 1/4"	10 1/8"	72"	9 1/2"	4	5			\$ 1,313	
DM-7210-A-30	Single Face Adder	30 1/4"	10 1/8"	72"	9 1/2"	4	5			\$ 994	
DM-7212-S-30	Single Face Starter	31 1/4"	12 1/8"	72"	11 1/2"	4	5			\$ 1,350	
DM-7212-A-30	Single Face Adder	30 1/4"	12 1/8"	72"	11 1/2"	4	5			\$ 1,025	
DM-7210-S-36	Single Face Starter	37 1/4"	10 1/8"	72"	9 1/2"	4	5	115 Lbs.	7 Cu Ft	\$ 1,156	
DM-7210-A-36	Single Face Adder	36 1/4"	10 1/8"	72"	9 1/2"	4	5	96.6 Lbs.	7 Cu Ft	\$ 844	
DM-7212-S-36	Single Face Starter	37 1/4"	12 1/8"	72"	11 1/2"	4	5	131 Lbs.	8 Cu Ft	\$ 1,200	
DM-7212-A-36	Single Face Adder	36 1/4"	12 1/8"	72"	11 1/2"	4	5	109 Lbs.	8 Cu Ft	\$ 869	

Model Shown
DM-7212-S-36









Model Shown
DM-7212-A-36

SHELVING

MODEL NUMBER	PRODUCT	WIDTH	DEPTH	HEIGHT	SHELF DEPTH	# OF SHELVES	# OF OPENINGS	WEIGHT	VOLUME	LIST PRICE	DESCRIPTION
 DM-8210-S-24	Single Face Starter	25 1/4"	10 1/8"	82"	9 1/2"	5	6			\$ 1,381	End, Mid, Top and Base Panels to be constructed from 1" thick 11-ply solid core, veneered 2 sides. Vertical, top and bottom edges banded with 1/4" external hardwood edging, edges to be eased. Front Edge: 3/4" thick x 2 1/2" high fascia - tongue and grooved to top.
DM-8210-A-24	Single Face Adder	24 1/4"	10 1/8"	82"	9 1/2"	5	6			\$ 1,069	
DM-8212-S-24	Single Face Starter	25 1/4"	12 1/8"	82"	11 1/2"	5	6			\$ 1,425	
DM-8212-A-24	Single Face Adder	24 1/4"	12 1/8"	82"	11 1/2"	5	6			\$ 1,094	
DM-8210-S-30	Single Face Starter	31 1/4"	10 1/8"	82"	9 1/2"	5	6			\$ 1,381	
DM-8210-A-30	Single Face Adder	30 1/4"	10 1/8"	82"	9 1/2"	5	6			\$ 1,069	
DM-8212-S-30	Single Face Starter	31 1/4"	12 1/8"	82"	11 1/2"	5	6			\$ 1,425	
DM-8212-A-30	Single Face Adder	30 1/4"	12 1/8"	82"	11 1/2"	5	6			\$ 1,094	
DM-8210-S-36	Single Face Starter	37 1/4"	10 1/8"	82"	9 1/2"	5	6	129 Lbs.	8 Cu Ft	\$ 1,225	
DM-8210-A-36	Single Face Adder	36 1/4"	10 1/8"	82"	9 1/2"	5	6	107 Lbs.	7 Cu Ft	\$ 913	
DM-8212-S-36	Single Face Starter	37 1/4"	12 1/8"	82"	11 1/2"	5	6	145 Lbs.	9 Cu Ft	\$ 1,269	
DM-8212-A-36	Single Face Adder	36 1/4"	12 1/8"	82"	11 1/2"	5	6	122 Lbs.	8 Cu Ft	\$ 938	
 DM-8212-A-36											
DM-9610-S-24	Single Face Starter	25 1/4"	10 1/8"	96"	9 1/2"	6	7			\$ 1,444	
DM-9610-A-24	Single Face Adder	24 1/4"	10 1/8"	96"	9 1/2"	6	7			\$ 1,131	
DM-9612-S-24	Single Face Starter	25 1/4"	12 1/8"	96"	11 1/2"	6	7			\$ 1,500	
DM-9612-A-24	Single Face Adder	24 1/4"	12 1/8"	96"	11 1/2"	6	7			\$ 1,169	
DM-9610-S-30	Single Face Starter	31 1/4"	10 1/8"	96"	9 1/2"	6	7			\$ 1,444	
DM-9610-A-30	Single Face Adder	30 1/4"	10 1/8"	96"	9 1/2"	6	7			\$ 1,131	
DM-9612-S-30	Single Face Starter	31 1/4"	12 1/8"	96"	11 1/2"	6	7			\$ 1,500	
DM-9612-A-30	Single Face Adder	30 1/4"	12 1/8"	96"	11 1/2"	6	7			\$ 1,169	
DM-9610-S-36	Single Face Starter	37 1/4"	10 1/8"	96"	9 1/2"	6	7	156 Lbs.	9 Cu Ft	\$ 1,294	
DM-9610-A-36	Single Face Adder	36 1/4"	10 1/8"	96"	9 1/2"	6	7	128 Lbs.	8 Cu Ft	\$ 981	
DM-9612-S-36	Single Face Starter	37 1/4"	12 1/8"	96"	11 1/2"	6	7	177 Lbs.	10 Cu Ft	\$ 1,350	
DM-9612-A-36	Single Face Adder	36 1/4"	12 1/8"	96"	11 1/2"	6	7	145 Lbs.	9 Cu Ft	\$ 1,019	
 DM-9612-A-36											

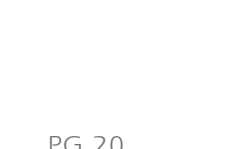



SHELVING

		MODEL NUMBER	PRODUCT	WIDTH	DEPTH	HEIGHT	SHELF DEPTH	# OF SHELVES	# OF OPENINGS	WEIGHT	VOLUME	LIST PRICE	DESCRIPTION
 Model Shown DM-3624-S-36		DM-3620-S-24	Double Face Starter	25 1/4"	19 1/2"	36"	9 1/2"	2	4			\$ 1,919	End, Mid, Top and Base Panels to be constructed from 1" thick 11-ply solid core, veneered 2 sides. Vertical, top and bottom edges banded with 1/4" external hardwood edging, edges to be eased. Front Edge: 3/4" thick x 2 1/2" high fascia - tongue and grooved to top.
		DM-3620-A-24	Double Face Adder	24 1/4"	19 1/2"	36"	9 1/2"	2	4			\$ 1,375	
		DM-3624-S-24	Double Face Starter	25 1/4"	23 1/2"	36"	11 1/2"	2	4			\$ 1,944	
		DM-3624-A-24	Double Face Adder	24 1/4"	23 1/2"	36"	11 1/2"	2	4			\$ 1,388	
 Model Shown DM-3624-S-36		DM-3620-S-30	Double Face Starter	31 1/4"	19 1/2"	36"	9 1/2"	2	4			\$ 1,919	
		DM-3620-A-30	Double Face Adder	30 1/4"	19 1/2"	36"	9 1/2"	2	4			\$ 1,375	
		DM-3624-S-30	Double Face Starter	31 1/4"	23 1/2"	36"	11 1/2"	2	4			\$ 1,944	
		DM-3624-A-30	Double Face Adder	30 1/4"	23 1/2"	36"	11 1/2"	2	4			\$ 1,388	
 Model Shown DM-3624-S-36		DM-3620-S-36	Double Face Starter	37 1/4"	19 1/2"	36"	9 1/2"	2	4	88.6 Lbs.	7 Cu Ft	\$ 1,694	
		DM-3620-A-36	Double Face Adder	36 1/4"	19 1/2"	36"	9 1/2"	2	4	73.6 Lbs.	6 Cu Ft	\$ 1,150	
		DM-3624-S-36	Double Face Starter	37 1/4"	23 1/2"	36"	11 1/2"	2	4	110 Lbs.	10 Cu Ft	\$ 1,719	
		DM-3624-A-36	Double Face Adder	36 1/4"	23 1/2"	36"	11 1/2"	2	4	88.6 Lbs.	9 Cu Ft	\$ 1,156	
 Model Shown DM-4224-S-36		DM-4220-S-24	Double Face Starter	25 1/4"	19 1/2"	42"	9 1/2"	4	6			\$ 2,063	
		DM-4220-A-24	Double Face Adder	24 1/4"	19 1/2"	42"	9 1/2"	4	6			\$ 1,525	
		DM-4224-S-24	Double Face Starter	25 1/4"	23 1/2"	42"	11 1/2"	4	6			\$ 2,094	
		DM-4224-A-24	Double Face Adder	24 1/4"	23 1/2"	42"	11 1/2"	4	6			\$ 1,538	
 Model Shown DM-4224-S-36		DM-4220-S-30	Double Face Starter	31 1/4"	19 1/2"	42"	9 1/2"	4	6			\$ 2,063	
		DM-4220-A-30	Double Face Adder	30 1/4"	19 1/2"	42"	9 1/2"	4	6			\$ 1,525	
		DM-4224-S-30	Double Face Starter	31 1/4"	23 1/2"	42"	11 1/2"	4	6			\$ 2,094	
		DM-4224-A-30	Double Face Adder	30 1/4"	23 1/2"	42"	11 1/2"	4	6			\$ 1,538	
 Model Shown DM-4224-S-36		DM-4220-S-36	Double Face Starter	37 1/4"	19 1/2"	42"	9 1/2"	4	6	94 Lbs.	7 Cu Ft	\$ 1,838	
		DM-4220-A-36	Double Face Adder	36 1/4"	19 1/2"	42"	9 1/2"	4	6	78 Lbs.	7 Cu Ft	\$ 1,294	
		DM-4224-S-36	Double Face Starter	37 1/4"	23 1/2"	42"	11 1/2"	4	6	115 Lbs.	10 Cu Ft	\$ 1,869	
		DM-4224-A-36	Double Face Adder	36 1/4"	23 1/2"	42"	11 1/2"	4	6	113 Lbs.	10 Cu Ft	\$ 1,306	

	MODEL NUMBER	PRODUCT	WIDTH	DEPTH	HEIGHT	SHELF DEPTH	# OF SHELVES	# OF OPENINGS	WEIGHT	VOLUME	LIST PRICE	DESCRIPTION
 Model Shown DM-4224-S-36	DM-4820-S-24	Double Face Starter	25 1/4"	19 1/2"	48"	9 1/2"	4	6			\$ 2,169	End, Mid, Top and Base Panels to be constructed from 1" thick 11-ply solid core, veneered 2 sides. Vertical, top and bottom edges banded with 1/4" external hardwood edging, edges to be eased. Front Edge: 3/4" thick x 2 1/2" high fascia - tongue and grooved to top.
	DM-4820-A-24	Double Face Adder	24 1/4"	19 1/2"	48"	9 1/2"	4	6			\$ 1,594	
	DM-4824-S-24	Double Face Starter	25 1/4"	23 1/2"	48"	11 1/2"	4	6			\$ 2,200	
	DM-4824-A-24	Double Face Adder	24 1/4"	23 1/2"	48"	11 1/2"	4	6			\$ 1,619	
	DM-4820-S-30	Double Face Starter	31 1/4"	19 1/2"	48"	9 1/2"	4	6			\$ 2,169	
	DM-4820-A-30	Double Face Adder	30 1/4"	19 1/2"	48"	9 1/2"	4	6			\$ 1,594	
	DM-4824-S-30	Double Face Starter	31 1/4"	23 1/2"	48"	11 1/2"	4	6			\$ 2,200	
	DM-4824-A-30	Double Face Adder	30 1/4"	23 1/2"	48"	11 1/2"	4	6			\$ 1,619	
	DM-4820-S-36	Double Face Starter	37 1/4"	19 1/2"	48"	9 1/2"	4	6	132 Lbs.	9 Cu Ft	\$ 1,931	
	DM-4820-A-36	Double Face Adder	36 1/4"	19 1/2"	48"	9 1/2"	4	6	109 Lbs.	8 Cu Ft	\$ 1,356	
	DM-4824-S-36	Double Face Starter	37 1/4"	23 1/2"	48"	11 1/2"	4	6	155 Lbs.	11 Cu Ft	\$ 1,963	
	DM-4824-A-36	Double Face Adder	36 1/4"	23 1/2"	48"	11 1/2"	4	6	127 Lbs.	10 Cu Ft	\$ 1,369	
 Model Shown DM-4224-A-36	DM-6020-S-24	Double Face Starter	25 1/4"	19 1/2"	60"	9 1/2"	6	8			\$ 2,188	
	DM-6020-A-24	Double Face Adder	24 1/4"	19 1/2"	60"	9 1/2"	6	8			\$ 1,619	
	DM-6024-S-24	Double Face Starter	25 1/4"	23 1/2"	60"	11 1/2"	6	8			\$ 2,213	
	DM-6024-A-24	Double Face Adder	24 1/4"	23 1/2"	60"	11 1/2"	6	8			\$ 1,656	
	DM-6020-S-30	Double Face Starter	31 1/4"	19 1/2"	60"	9 1/2"	6	8			\$ 2,188	
	DM-6020-A-30	Double Face Adder	30 1/4"	19 1/2"	60"	9 1/2"	6	8			\$ 1,619	
	DM-6024-S-30	Double Face Starter	31 1/4"	23 1/2"	60"	11 1/2"	6	8			\$ 2,213	
	DM-6024-A-30	Double Face Adder	30 1/4"	23 1/2"	60"	11 1/2"	6	8			\$ 1,656	
	DM-6020-S-36	Double Face Starter	37 1/4"	19 1/2"	60"	9 1/2"	6	8	176 Lbs.	11 Cu Ft	\$ 1,956	
	DM-6020-A-36	Double Face Adder	36 1/4"	19 1/2"	60"	9 1/2"	6	8	145 Lbs.	10 Cu Ft	\$ 1,388	
	DM-6024-S-36	Double Face Starter	37 1/4"	23 1/2"	60"	11 1/2"	6	8	200 Lbs.	12 Cu Ft	\$ 1,981	
	DM-6024-A-36	Double Face Adder	36 1/4"	23 1/2"	60"	11 1/2"	6	8	164 Lbs.	11 Cu Ft	\$ 1,419	

Model Shown
DM-6024-A-36

SHELVING

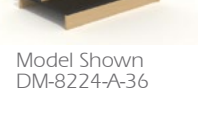
MODEL NUMBER	PRODUCT	WIDTH	DEPTH	HEIGHT	SHELF DEPTH	# OF SHELVES	# OF OPENINGS	WEIGHT	VOLUME	LIST PRICE	DESCRIPTION	
	DM-7220-S-24 Double Face Starter	25 ¹ / ₄ "	19 ¹ / ₂ "	72"	9 ¹ / ₂ "	8	10			\$ 2,331	End, Mid, Top and Base Panels to be constructed from 1" thick 11-ply solid core, veneered 2 sides. Vertical, top and bottom edges banded with 1/4" external hardwood edging, edges to be eased. Front Edge: 3/4" thick x 2 1/2" high fascia - tongue and grooved to top.	
	DM-7220-A-24 Double Face Adder	24 ¹ / ₄ "	19 ¹ / ₂ "	72"	9 ¹ / ₂ "	8	10			\$ 1,756		
	DM-7224-S-24 Double Face Starter	25 ¹ / ₄ "	23 ¹ / ₂ "	72"	11 ¹ / ₂ "	8	10			\$ 2,356		
	DM-7224-A-24 Double Face Adder	24 ¹ / ₄ "	23 ¹ / ₂ "	72"	11 ¹ / ₂ "	8	10			\$ 1,794		
	DM-7220-S-30 Double Face Starter	31 ¹ / ₄ "	19 ¹ / ₂ "	72"	9 ¹ / ₂ "	8	10			\$ 2,331		
	DM-7220-A-30 Double Face Adder	30 ¹ / ₄ "	19 ¹ / ₂ "	72"	9 ¹ / ₂ "	8	10			\$ 1,756		
	DM-7224-S-30 Double Face Starter	31 ¹ / ₄ "	23 ¹ / ₂ "	72"	11 ¹ / ₂ "	8	10			\$ 2,356		
	DM-7224-A-30 Double Face Adder	30 ¹ / ₄ "	23 ¹ / ₂ "	72"	11 ¹ / ₂ "	8	10			\$ 1,794		
	DM-7220-S-36 Double Face Starter	37 ¹ / ₄ "	19 ¹ / ₂ "	72"	9 ¹ / ₂ "	8	10	200 Lbs.	12 Cu Ft	\$ 2,094		
	DM-7220-A-36 Double Face Adder	36 ¹ / ₄ "	19 ¹ / ₂ "	72"	9 ¹ / ₂ "	8	10	164 Lbs.	11 Cu Ft	\$ 1,525		
	DM-7224-S-36 Double Face Starter	37 ¹ / ₄ "	23 ¹ / ₂ "	72"	11 ¹ / ₂ "	8	10	229 Lbs.	13 Cu Ft	\$ 2,131		
	DM-7224-A-36 Double Face Adder	36 ¹ / ₄ "	23 ¹ / ₂ "	72"	11 ¹ / ₂ "	8	10	186 Lbs.	12 Cu Ft	\$ 1,556		
	Model Shown DM-7224-S-36											
	Model Shown DM-7224-A-36											
	DM-8220-S-24 Double Face Starter	25 ¹ / ₄ "	19 ¹ / ₂ "	82"	9 ¹ / ₂ "	10	12			\$ 2,456		
	DM-8220-A-24 Double Face Adder	24 ¹ / ₄ "	19 ¹ / ₂ "	82"	9 ¹ / ₂ "	10	12			\$ 1,894		
	DM-8224-S-24 Double Face Starter	25 ¹ / ₄ "	23 ¹ / ₂ "	82"	11 ¹ / ₂ "	10	12			\$ 2,500		
	DM-8224-A-24 Double Face Adder	24 ¹ / ₄ "	23 ¹ / ₂ "	82"	11 ¹ / ₂ "	10	12			\$ 1,944		
	DM-8220-S-30 Double Face Starter	31 ¹ / ₄ "	19 ¹ / ₂ "	82"	9 ¹ / ₂ "	10	12			\$ 2,456		
	DM-8220-A-30 Double Face Adder	30 ¹ / ₄ "	19 ¹ / ₂ "	82"	9 ¹ / ₂ "	10	12			\$ 1,894		
	DM-8224-S-30 Double Face Starter	31 ¹ / ₄ "	23 ¹ / ₂ "	82"	11 ¹ / ₂ "	10	12			\$ 2,500		
	DM-8224-A-30 Double Face Adder	30 ¹ / ₄ "	23 ¹ / ₂ "	82"	11 ¹ / ₂ "	10	12			\$ 1,944		
	DM-8220-S-36 Double Face Starter	37 ¹ / ₄ "	19 ¹ / ₂ "	82"	9 ¹ / ₂ "	10	12	224 Lbs.	12 Cu Ft	\$ 2,225		
	DM-8220-A-36 Double Face Adder	36 ¹ / ₄ "	19 ¹ / ₂ "	82"	9 ¹ / ₂ "	10	12	184 Lbs.	11 Cu Ft	\$ 1,669		
	DM-8224-S-36 Double Face Starter	37 ¹ / ₄ "	23 ¹ / ₂ "	82"	11 ¹ / ₂ "	10	12	256 Lbs.	14 Cu Ft	\$ 2,269		
	DM-8224-A-36 Double Face Adder	36 ¹ / ₄ "	23 ¹ / ₂ "	82"	11 ¹ / ₂ "	10	12	207 Lbs.	12 Cu Ft	\$ 1,706		
	Model Shown DM-8224-S-36											
	Model Shown DM-8224-A-36											

MODEL NUMBER	PRODUCT	WIDTH	DEPTH	HEIGHT	SHELF DEPTH	# OF SHELVES	# OF OPENINGS	WEIGHT	VOLUME	LIST PRICE	DESCRIPTION
DM-9620-S-24	Double Face Starter	25 1/4"	19 1/2"	96"	9 1/2"	12	14			\$ 2,600	End, Mid, Top and Base Panels to be constructed from 1" thick 11-ply solid core, veneered 2 sides. Vertical, top and bottom edges banded with 1/4" external hardwood edging, edges to be eased. Front Edge: 3/4" thick x 2 1/2" high fascia - tongue and grooved to top.
DM-9620-A-24	Double Face Adder	24 1/4"	19 1/2"	96"	9 1/2"	12	14			\$ 2,031	
DM-9624-S-24	Double Face Starter	25 1/4"	23 1/2"	96"	11 1/2"	12	14			\$ 2,644	
DM-9624-A-24	Double Face Adder	24 1/4"	23 1/2"	96"	11 1/2"	12	14			\$ 2,081	
DM-9620-S-30	Double Face Starter	31 1/4"	19 1/2"	96"	9 1/2"	12	14			\$ 2,600	
DM-9620-A-30	Double Face Adder	30 1/4"	19 1/2"	96"	9 1/2"	12	14			\$ 2,031	
DM-9624-S-30	Double Face Starter	31 1/4"	23 1/2"	96"	11 1/2"	12	14			\$ 2,644	
DM-9624-A-30	Double Face Adder	30 1/4"	23 1/2"	96"	11 1/2"	12	14			\$ 2,081	
DM-9620-S-36	Double Face Starter	37 1/4"	19 1/2"	96"	9 1/2"	12	14	276 Lbs.	13 Cu Ft	\$ 2,369	
DM-9620-A-36	Double Face Adder	36 1/4"	19 1/2"	96"	9 1/2"	12	14	220 Lbs.	12 Cu Ft	\$ 1,800	
DM-9624-S-36	Double Face Starter	37 1/4"	23 1/2"	96"	11 1/2"	12	14	315 Lbs.	15 Cu Ft	\$ 2,406	
DM-9624-A-36	Double Face Adder	36 1/4"	23 1/2"	96"	11 1/2"	12	14	247 Lbs.	13 Cu Ft	\$ 1,850	







Model Shown
DM-9624-S-36



Model Shown
DM-9624-A-36

SHELVING

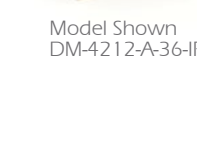
	MODEL NUMBER	PRODUCT	WIDTH	DEPTH	HEIGHT	SHELF DEPTH	# OF SHELVES	# OF OPENINGS	WEIGHT	VOLUME	LIST PRICE	DESCRIPTION
 Model Shown DM-3612-S-36-IPT	DM-3610-S-24-IPT	Single Face Starter	25 1/4"	10 1/8"	36"	9 1/2"	1	2			\$ 1,175	End, Mid, Top and Base Panels to be constructed from 1" thick 11-ply solid core, veneered 2 sides. Vertical, top and bottom edges banded with 1/4" external hardwood edging, edges to be eased. Front Edge: 3/4" thick x 2 1/2" high fascia - tongue and grooved to top.
	DM-3610-A-24-IPT	Single Face Adder	24 1/4"	10 1/8"	36"	9 1/2"	1	2			\$ 863	
	DM-3612-S-24-IPT	Single Face Starter	25 1/4"	12 1/8"	36"	11 1/2"	1	2			\$ 1,213	
	DM-3612-A-24-IPT	Single Face Adder	24 1/4"	12 1/8"	36"	11 1/2"	1	2			\$ 881	
 Model Shown DM-3612-A-36-IPT	DM-3610-S-30-IPT	Single Face Starter	31 1/4"	10 1/8"	36"	9 1/2"	1	2			\$ 1,175	
	DM-3610-A-30-IPT	Single Face Adder	30 1/4"	10 1/8"	36"	9 1/2"	1	2			\$ 863	
	DM-3612-S-30-IPT	Single Face Starter	31 1/4"	12 1/8"	36"	11 1/2"	1	2			\$ 1,213	
	DM-3612-A-30-IPT	Single Face Adder	30 1/4"	12 1/8"	36"	11 1/2"	1	2			\$ 881	
 Model Shown DM-3612-A-36-IPT	DM-3610-S-36-IPT	Single Face Starter	37 1/4"	10 1/8"	36"	9 1/2"	1	2	50.6 Lbs.	4 Cu Ft	\$ 1,019	
	DM-3610-A-36-IPT	Single Face Adder	36 1/4"	10 1/8"	36"	9 1/2"	1	2	46 Lbs.	4 Cu Ft	\$ 706	
	DM-3612-S-36-IPT	Single Face Starter	37 1/4"	12 1/8"	36"	11 1/2"	1	2	50.6 Lbs.	5 Cu Ft	\$ 1,056	
	DM-3612-A-36-IPT	Single Face Adder	36 1/4"	12 1/8"	36"	11 1/2"	1	2	47.2 Lbs.	5 Cu Ft	\$ 731	
 Model Shown DM-4212-S-36-IPT	DM-4210-S-24-IPT	Single Face Starter	25 1/4"	10 1/8"	42"	9 1/2"	2	3			\$ 1,238	
	DM-4210-A-24-IPT	Single Face Adder	24 1/4"	10 1/8"	42"	9 1/2"	2	3			\$ 931	
	DM-4212-S-24-IPT	Single Face Starter	25 1/4"	12 1/8"	42"	11 1/2"	2	3			\$ 1,281	
	DM-4212-A-24-IPT	Single Face Adder	24 1/4"	12 1/8"	42"	11 1/2"	2	3			\$ 956	
 Model Shown DM-4212-A-36-IPT	DM-4210-S-30-IPT	Single Face Starter	31 1/4"	10 1/8"	42"	9 1/2"	2	3			\$ 1,238	
	DM-4210-A-30-IPT	Single Face Adder	30 1/4"	10 1/8"	42"	9 1/2"	2	3			\$ 931	
	DM-4212-S-30-IPT	Single Face Starter	31 1/4"	12 1/8"	42"	11 1/2"	2	3			\$ 1,281	
	DM-4212-A-30-IPT	Single Face Adder	30 1/4"	12 1/8"	42"	11 1/2"	2	3			\$ 956	
 Model Shown DM-4212-A-36-IPT	DM-4210-S-36-IPT	Single Face Starter	37 1/4"	10 1/8"	42"	9 1/2"	2	3	55 Lbs.	5 Cu Ft	\$ 1,088	
	DM-4210-A-36-IPT	Single Face Adder	36 1/4"	10 1/8"	42"	9 1/2"	2	3	52 Lbs.	5 Cu Ft	\$ 781	
	DM-4212-S-36-IPT	Single Face Starter	37 1/4"	12 1/8"	42"	11 1/2"	2	3	60 Lbs.	5 Cu Ft	\$ 1,131	
	DM-4212-A-36-IPT	Single Face Adder	36 1/4"	12 1/8"	42"	11 1/2"	2	3	53 Lbs.	5 Cu Ft	\$ 806	

SHELVING

MODEL NUMBER	PRODUCT	WIDTH	DEPTH	HEIGHT	SHELF DEPTH	# OF SHELVES	# OF OPENINGS	WEIGHT	VOLUME	LIST PRICE	DESCRIPTION
DM-4810-S-24-IPT	Single Face Starter	25 1/4"	10 1/8"	48"	9 1/2"	2	3			\$ 1,263	End, Mid, Top and Base Panels to be constructed from 1" thick 11-ply solid core, veneered 2 sides. Vertical, top and bottom edges banded with 1/4" external hardwood edging, edges to be eased. Front Edge: 3/4" thick x 2 1/2" high fascia - tongue and grooved to top.
DM-4810-A-24-IPT	Single Face Adder	24 1/4"	10 1/8"	48"	9 1/2"	2	3			\$ 944	
DM-4812-S-24-IPT	Single Face Starter	25 1/4"	12 1/8"	48"	11 1/2"	2	3			\$ 1,306	
DM-4812-A-24-IPT	Single Face Adder	24 1/4"	12 1/8"	48"	11 1/2"	2	3			\$ 956	
DM-4810-S-30-IPT	Single Face Starter	31 1/4"	10 1/8"	48"	9 1/2"	2	3			\$ 1,263	
DM-4810-A-30-IPT	Single Face Adder	30 1/4"	10 1/8"	48"	9 1/2"	2	3			\$ 944	
DM-4812-S-30-IPT	Single Face Starter	31 1/4"	12 1/8"	48"	11 1/2"	2	3			\$ 1,306	
DM-4812-A-30-IPT	Single Face Adder	30 1/4"	12 1/8"	48"	11 1/2"	2	3			\$ 956	
DM-4810-S-36-IPT	Single Face Starter	37 1/4"	10 1/8"	48"	9 1/2"	2	3	74.8 Lbs.	5 Cu Ft	\$ 1,119	
DM-4810-A-36-IPT	Single Face Adder	36 1/4"	10 1/8"	48"	9 1/2"	2	3	65.5 Lbs.	5 Cu Ft	\$ 794	
DM-4812-S-36-IPT	Single Face Starter	37 1/4"	12 1/8"	48"	11 1/2"	2	3	82.8 Lbs.	6 Cu Ft	\$ 1,156	
DM-4812-A-36-IPT	Single Face Adder	36 1/4"	12 1/8"	48"	11 1/2"	2	3	71.3 Lbs.	6 Cu Ft	\$ 806	



Model Shown
DM-4212-S-36-IPT



Model Shown
DM-4212-A-36-IPT









Model Shown
DM-6012-S-36-IPT



Model Shown
DM-6012-A-36-IPT

DM-6010-S-24-IPT	Single Face Starter	25 1/4"	10 1/8"	60"	9 1/2"	3	4			\$ 1,319
DM-6010-A-24-IPT	Single Face Adder	24 1/4"	10 1/8"	60"	9 1/2"	3	4			\$ 1,006
DM-6012-S-24-IPT	Single Face Starter	25 1/4"	12 1/8"	60"	11 1/2"	3	4			\$ 1,350
DM-6012-A-24-IPT	Single Face Adder	24 1/4"	12 1/8"	60"	11 1/2"	3	4			\$ 1,031
DM-6010-S-30-IPT	Single Face Starter	31 1/4"	10 1/8"	60"	9 1/2"	3	4			\$ 1,319
DM-6010-A-30-IPT	Single Face Adder	30 1/4"	10 1/8"	60"	9 1/2"	3	4			\$ 1,006
DM-6012-S-30-IPT	Single Face Starter	31 1/4"	12 1/8"	60"	11 1/2"	3	4			\$ 1,350
DM-6012-A-30-IPT	Single Face Adder	30 1/4"	12 1/8"	60"	11 1/2"	3	4			\$ 1,031
DM-6010-S-36-IPT	Single Face Starter	37 1/4"	10 1/8"	60"	9 1/2"	3	4	100 Lbs.	6 Cu Ft	\$ 1,169
DM-6010-A-36-IPT	Single Face Adder	36 1/4"	10 1/8"	60"	9 1/2"	3	4	86.3 Lbs.	6 Cu Ft	\$ 856
DM-6012-S-36-IPT	Single Face Starter	37 1/4"	12 1/8"	60"	11 1/2"	3	4	116 Lbs.	8 Cu Ft	\$ 1,200
DM-6012-A-36-IPT	Single Face Adder	36 1/4"	12 1/8"	60"	11 1/2"	3	4	95.5 Lbs.	7 Cu Ft	\$ 875

SHELVING

MODEL NUMBER	PRODUCT	WIDTH	DEPTH	HEIGHT	SHELF DEPTH	# OF SHELVES	# OF OPENINGS	WEIGHT	VOLUME	LIST PRICE	DESCRIPTION
	DM-3620-S-24-IPT Double Face Starter	25 1/4"	19 1/2"	36"	9 1/2"	2	4			\$ 2,075	End, Mid, Top and Base Panels to be constructed from 1" thick 11-ply solid core, veneered 2 sides. Vertical, top and bottom edges banded with 1/4" external hardwood edging, edges to be eased. Front Edge: 3/4" thick x 2 1/2" high fascia - tongue and grooved to top.
	DM-3620-A-24-IPT Double Face Adder	24 1/4"	19 1/2"	36"	9 1/2"	2	4			\$ 1,531	
	DM-3624-S-24-IPT Double Face Starter	25 1/4"	23 1/2"	36"	11 1/2"	2	4			\$ 2,106	
	DM-3624-A-24-IPT Double Face Adder	24 1/4"	23 1/2"	36"	11 1/2"	2	4			\$ 1,544	
	DM-3620-S-30-IPT Double Face Starter	31 1/4"	19 1/2"	36"	9 1/2"	2	4			\$ 2,075	
	DM-3620-A-30-IPT Double Face Adder	30 1/4"	19 1/2"	36"	9 1/2"	2	4			\$ 1,531	
	DM-3624-S-30-IPT Double Face Starter	31 1/4"	23 1/2"	36"	11 1/2"	2	4			\$ 2,106	
	DM-3624-A-30-IPT Double Face Adder	30 1/4"	23 1/2"	36"	11 1/2"	2	4			\$ 1,544	
	DM-3620-S-36-IPT Double Face Starter	37 1/4"	19 1/2"	36"	9 1/2"	2	4	88.6 Lbs.	7 Cu Ft	\$ 1,850	
	DM-3620-A-36-IPT Double Face Adder	36 1/4"	19 1/2"	36"	9 1/2"	2	4	73.6 Lbs.	6 Cu Ft	\$ 1,306	
	DM-3624-S-36-IPT Double Face Starter	37 1/4"	23 1/2"	36"	11 1/2"	2	4	110 Lbs.	10 Cu Ft	\$ 1,875	
	DM-3624-A-36-IPT Double Face Adder	36 1/4"	23 1/2"	36"	11 1/2"	2	4	88.6 Lbs.	9 Cu Ft	\$ 1,313	
	DM-4220-S-24-IPT Double Face Starter	25 1/4"	19 1/2"	42"	9 1/2"	4	6			\$ 2,219	
	DM-4220-A-24-IPT Double Face Adder	24 1/4"	19 1/2"	42"	9 1/2"	4	6			\$ 1,681	
	DM-4224-S-24-IPT Double Face Starter	25 1/4"	23 1/2"	42"	11 1/2"	4	6			\$ 2,256	
	DM-4224-A-24-IPT Double Face Adder	24 1/4"	23 1/2"	42"	11 1/2"	4	6			\$ 1,694	
	DM-4220-S-30-IPT Double Face Starter	31 1/4"	19 1/2"	42"	9 1/2"	4	6			\$ 2,219	
	DM-4220-A-30-IPT Double Face Adder	30 1/4"	19 1/2"	42"	9 1/2"	4	6			\$ 1,681	
	DM-4224-S-30-IPT Double Face Starter	31 1/4"	23 1/2"	42"	11 1/2"	4	6			\$ 2,256	
	DM-4224-A-30-IPT Double Face Adder	30 1/4"	23 1/2"	42"	11 1/2"	4	6			\$ 1,694	
	DM-4220-S-36-IPT Double Face Starter	37 1/4"	19 1/2"	42"	9 1/2"	4	6	94 Lbs.	7 Cu Ft	\$ 1,994	
	DM-4220-A-36-IPT Double Face Adder	36 1/4"	19 1/2"	42"	9 1/2"	4	6	78 Lbs.	7 Cu Ft	\$ 1,444	
	DM-4224-S-36-IPT Double Face Starter	37 1/4"	23 1/2"	42"	11 1/2"	4	6	115 Lbs.	10 Cu Ft	\$ 2,025	
	DM-4224-A-36-IPT Double Face Adder	36 1/4"	23 1/2"	42"	11 1/2"	4	6	113 Lbs.	10 Cu Ft	\$ 1,456	

Model Shown
DM-4224-A-36-IPT

MODEL NUMBER	PRODUCT	WIDTH	DEPTH	HEIGHT	SHELF DEPTH	# OF SHELVES	# OF OPENINGS	WEIGHT	VOLUME	LIST PRICE	DESCRIPTION
DM-4820-S-24-IPT	Double Face Starter	25 1/4"	19 1/2"	48"	9 1/2"	4	6			\$ 2,325	End, Mid, Top and Base Panels to be constructed from 1" thick 11-ply solid core, veneered 2 sides. Vertical, top and bottom edges banded with 1/4" external hardwood edging, edges to be eased. Front Edge: 3/4" thick x 2 1/2" high fascia - tongue and grooved to top.
DM-4820-A-24-IPT	Double Face Adder	24 1/4"	19 1/2"	48"	9 1/2"	4	6			\$ 1,750	
DM-4824-S-24-IPT	Double Face Starter	25 1/4"	23 1/2"	48"	11 1/2"	4	6			\$ 2,356	
DM-4824-A-24-IPT	Double Face Adder	24 1/4"	23 1/2"	48"	11 1/2"	4	6			\$ 1,769	
DM-4820-S-30-IPT	Double Face Starter	31 1/4"	19 1/2"	48"	9 1/2"	4	6			\$ 2,325	
DM-4820-A-30-IPT	Double Face Adder	30 1/4"	19 1/2"	48"	9 1/2"	4	6			\$ 1,750	
DM-4824-S-30-IPT	Double Face Starter	31 1/4"	23 1/2"	48"	11 1/2"	4	6			\$ 2,356	
DM-4824-A-30-IPT	Double Face Adder	30 1/4"	23 1/2"	48"	11 1/2"	4	6			\$ 1,769	
DM-4820-S-36-IPT	Double Face Starter	37 1/4"	19 1/2"	48"	9 1/2"	4	6	132 Lbs.	9 Cu Ft	\$ 2,081	
DM-4820-A-36-IPT	Double Face Adder	36 1/4"	19 1/2"	48"	9 1/2"	4	6	109 Lbs.	8 Cu Ft	\$ 1,513	
DM-4824-S-36-IPT	Double Face Starter	37 1/4"	23 1/2"	48"	11 1/2"	4	6	155 Lbs.	11 Cu Ft	\$ 2,119	
DM-4824-A-36-IPT	Double Face Adder	36 1/4"	23 1/2"	48"	11 1/2"	4	6	127 Lbs.	10 Cu Ft	\$ 1,525	
DM-6020-S-24-IPT	Double Face Starter	25 1/4"	19 1/2"	60"	9 1/2"	6	8			\$ 2,344	
DM-6020-A-24-IPT	Double Face Adder	24 1/4"	19 1/2"	60"	9 1/2"	6	8			\$ 1,781	
DM-6024-S-24-IPT	Double Face Starter	25 1/4"	23 1/2"	60"	11 1/2"	6	8			\$ 2,369	
DM-6024-A-24-IPT	Double Face Adder	24 1/4"	23 1/2"	60"	11 1/2"	6	8			\$ 1,813	
DM-6020-S-30-IPT	Double Face Starter	31 1/4"	19 1/2"	60"	9 1/2"	6	8			\$ 2,344	
DM-6020-A-30-IPT	Double Face Adder	30 1/4"	19 1/2"	60"	9 1/2"	6	8			\$ 1,781	
DM-6024-S-30-IPT	Double Face Starter	31 1/4"	23 1/2"	60"	11 1/2"	6	8			\$ 2,369	
DM-6024-A-30-IPT	Double Face Adder	30 1/4"	23 1/2"	60"	11 1/2"	6	8			\$ 1,813	
DM-6020-S-36-IPT	Double Face Starter	37 1/4"	19 1/2"	60"	9 1/2"	6	8	176 Lbs.	11 Cu Ft	\$ 2,106	
DM-6020-A-36-IPT	Double Face Adder	36 1/4"	19 1/2"	60"	9 1/2"	6	8	145 Lbs.	10 Cu Ft	\$ 1,544	
DM-6024-S-36-IPT	Double Face Starter	37 1/4"	23 1/2"	60"	11 1/2"	6	8	200 Lbs.	12 Cu Ft	\$ 2,138	
DM-6024-A-36-IPT	Double Face Adder	36 1/4"	23 1/2"	60"	11 1/2"	6	8	164 Lbs.	11 Cu Ft	\$ 1,575	



Model Shown
DM-4224-S-36-IPT



Model Shown
DM-4224-A-36-IPT













Model Shown
DM-6024-S-36-IPT

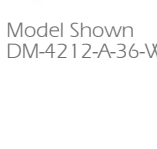

Model Shown
DM-6024-A-36-IPT

SHELVING

	MODEL NUMBER	PRODUCT	WIDTH	DEPTH	HEIGHT	SHELF DEPTH	# OF SHELVES	# OF OPENINGS	WEIGHT	VOLUME	LIST PRICE	DESCRIPTION
	DM-3610-S-24-WG	Single Face Starter	25 1/4"	10 1/8"	36"	8 1/2"	1	2			\$ 2,000	End, Mid, Top and Base Panels to be constructed from 1" thick 11-ply solid core, veneered 2 sides. Vertical, top and bottom edges banded with 1/4" external hardwood edging, edges to be eased. Front Edge: 3/4" thick x 2 1/2" high fascia - tongue and grooved to top.
	DM-3610-A-24-WG	Single Face Adder	24 1/4"	10 1/8"	36"	8 1/2"	1	2			\$ 1,706	
	DM-3612-S-24-WG	Single Face Starter	25 1/4"	12 1/8"	36"	10 1/2"	1	2			\$ 2,038	
	DM-3612-A-24-WG	Single Face Adder	24 1/4"	12 1/8"	36"	10 1/2"	1	2			\$ 1,731	
Model Shown DM-3612-S-36-WG 	DM-3610-S-30-WG	Single Face Starter	31 1/4"	10 1/8"	36"	8 1/2"	1	2			\$ 2,000	
	DM-3610-A-30-WG	Single Face Adder	30 1/4"	10 1/8"	36"	8 1/2"	1	2			\$ 1,706	
	DM-3612-S-30-WG	Single Face Starter	31 1/4"	12 1/8"	36"	10 1/2"	1	2			\$ 2,038	
	DM-3612-A-30-WG	Single Face Adder	30 1/4"	12 1/8"	36"	10 1/2"	1	2			\$ 1,731	
Model Shown DM-3612-A-36-WG 	DM-3610-S-36-WG	Single Face Starter	37 1/4"	10 1/8"	36"	8 1/2"	1	2	50.6 Lbs.	4 Cu Ft	\$ 1,856	
	DM-3610-A-36-WG	Single Face Adder	36 1/4"	10 1/8"	36"	8 1/2"	1	2	46 Lbs.	4 Cu Ft	\$ 1,556	
	DM-3612-S-36-WG	Single Face Starter	37 1/4"	12 1/8"	36"	10 1/2"	1	2	50.6 Lbs.	5 Cu Ft	\$ 1,894	
	DM-3612-A-36-WG	Single Face Adder	36 1/4"	12 1/8"	36"	10 1/2"	1	2	47.2 Lbs.	5 Cu Ft	\$ 1,581	
	DM-4210-S-24-WG	Single Face Starter	25 1/4"	10 1/8"	42"	8 1/2"	2	3			\$ 2,081	
	DM-4210-A-24-WG	Single Face Adder	24 1/4"	10 1/8"	42"	8 1/2"	2	3			\$ 1,794	
	DM-4212-S-24-WG	Single Face Starter	25 1/4"	12 1/8"	42"	10 1/2"	2	3			\$ 2,131	
	DM-4212-A-24-WG	Single Face Adder	24 1/4"	12 1/8"	42"	10 1/2"	2	3			\$ 1,819	
Model Shown DM-4212-S-36-WG 	DM-4210-S-30-WG	Single Face Starter	31 1/4"	10 1/8"	42"	8 1/2"	2	3			\$ 2,081	
	DM-4210-A-30-WG	Single Face Adder	30 1/4"	10 1/8"	42"	8 1/2"	2	3			\$ 1,794	
	DM-4212-S-30-WG	Single Face Starter	31 1/4"	12 1/8"	42"	10 1/2"	2	3			\$ 2,131	
	DM-4212-A-30-WG	Single Face Adder	30 1/4"	12 1/8"	42"	10 1/2"	2	3			\$ 1,819	
	DM-4210-S-36-WG	Single Face Starter	37 1/4"	10 1/8"	42"	8 1/2"	2	3	55 Lbs.	5 Cu Ft	\$ 1,944	
	DM-4210-A-36-WG	Single Face Adder	36 1/4"	10 1/8"	42"	8 1/2"	2	3	52 Lbs.	5 Cu Ft	\$ 1,650	
	DM-4212-S-36-WG	Single Face Starter	37 1/4"	12 1/8"	42"	10 1/2"	2	3	60 Lbs.	5 Cu Ft	\$ 1,988	
	DM-4212-A-36-WG	Single Face Adder	36 1/4"	12 1/8"	42"	10 1/2"	2	3	53 Lbs.	5 Cu Ft	\$ 1,675	

	MODEL NUMBER	PRODUCT	WIDTH	DEPTH	HEIGHT	SHELF DEPTH	# OF SHELVES	# OF OPENINGS	WEIGHT	VOLUME	LIST PRICE	DESCRIPTION
	DM-4810-S-24-WG	Single Face Starter	25 1/4"	10 1/8"	48"	8 1/2"	2	3			\$ 2,144	End, Mid, Top and Base Panels to be constructed from 1" thick 11-ply solid core, veneered 2 sides. Vertical, top and bottom edges banded with 1/4" external hardwood edging, edges to be eased. Front Edge: 3/4" thick x 2 1/2" high fascia - tongue and grooved to top.
	DM-4810-A-24-WG	Single Face Adder	24 1/4"	10 1/8"	48"	8 1/2"	2	3			\$ 1,838	
	DM-4812-S-24-WG	Single Face Starter	25 1/4"	12 1/8"	48"	10 1/2"	2	3			\$ 2,163	
	DM-4812-A-24-WG	Single Face Adder	24 1/4"	12 1/8"	48"	10 1/2"	2	3			\$ 1,863	
	DM-4810-S-30-WG	Single Face Starter	31 1/4"	10 1/8"	48"	8 1/2"	2	3			\$ 2,144	
	DM-4810-A-30-WG	Single Face Adder	30 1/4"	10 1/8"	48"	8 1/2"	2	3			\$ 1,838	
	DM-4812-S-30-WG	Single Face Starter	31 1/4"	12 1/8"	48"	10 1/2"	2	3			\$ 2,163	
	DM-4812-A-30-WG	Single Face Adder	30 1/4"	12 1/8"	48"	10 1/2"	2	3			\$ 1,863	
	DM-4810-S-36-WG	Single Face Starter	37 1/4"	10 1/8"	48"	8 1/2"	2	3	74.8 Lbs.	5 Cu Ft	\$ 2,000	
	DM-4810-A-36-WG	Single Face Adder	36 1/4"	10 1/8"	48"	8 1/2"	2	3	65.5 Lbs.	5 Cu Ft	\$ 1,694	
	DM-4812-S-36-WG	Single Face Starter	37 1/4"	12 1/8"	48"	10 1/2"	2	3	82.8 Lbs.	6 Cu Ft	\$ 2,019	
	DM-4812-A-36-WG	Single Face Adder	36 1/4"	12 1/8"	48"	10 1/2"	2	3	71.3 Lbs.	6 Cu Ft	\$ 1,694	
	DM-6010-S-24-WG	Single Face Starter	25 1/4"	10 1/8"	60"	8 1/2"	3	4			\$ 2,731	
	DM-6010-A-24-WG	Single Face Adder	24 1/4"	10 1/8"	60"	8 1/2"	3	4			\$ 2,431	
	DM-6012-S-24-WG	Single Face Starter	25 1/4"	12 1/8"	60"	10 1/2"	3	4			\$ 2,775	
	DM-6012-A-24-WG	Single Face Adder	24 1/4"	12 1/8"	60"	10 1/2"	3	4			\$ 2,463	
	DM-6010-S-30-WG	Single Face Starter	31 1/4"	10 1/8"	60"	8 1/2"	3	4			\$ 2,731	
	DM-6010-A-30-WG	Single Face Adder	30 1/4"	10 1/8"	60"	8 1/2"	3	4			\$ 2,431	
	DM-6012-S-30-WG	Single Face Starter	31 1/4"	12 1/8"	60"	10 1/2"	3	4			\$ 2,775	
	DM-6012-A-30-WG	Single Face Adder	30 1/4"	12 1/8"	60"	10 1/2"	3	4			\$ 2,463	
	DM-6010-S-36-WG	Single Face Starter	37 1/4"	10 1/8"	60"	8 1/2"	3	4	100 Lbs.	6 Cu Ft	\$ 2,581	
	DM-6010-A-36-WG	Single Face Adder	36 1/4"	10 1/8"	60"	8 1/2"	3	4	86.3 Lbs.	6 Cu Ft	\$ 2,288	
	DM-6012-S-36-WG	Single Face Starter	37 1/4"	12 1/8"	60"	10 1/2"	3	4	116 Lbs.	8 Cu Ft	\$ 2,625	
	DM-6012-A-36-WG	Single Face Adder	36 1/4"	12 1/8"	60"	10 1/2"	3	4	95.5 Lbs.	7 Cu Ft	\$ 2,319	

MODEL NUMBER	PRODUCT	WIDTH	DEPTH	HEIGHT	SHELF DEPTH	# OF SHELVES	# OF OPENINGS	WEIGHT	VOLUME	LIST PRICE	DESCRIPTION
		25 1/4"	10 1/8"	72"	8 1/2"	4	5			\$ 2,813	End, Mid, Top and Base Panels to be constructed from 1" thick 11-ply solid core, veneered 2 sides. Vertical, top and bottom edges banded with 1/4" external hardwood edging, edges to be eased. Front Edge: 3/4" thick x 2 1/2" high fascia - tongue and grooved to top.
		24 1/4"	10 1/8"	72"	8 1/2"	4	5			\$ 2,513	
		25 1/4"	12 1/8"	72"	10 1/2"	4	5			\$ 2,863	
		24 1/4"	12 1/8"	72"	10 1/2"	4	5			\$ 2,550	
		31 1/4"	10 1/8"	72"	8 1/2"	4	5			\$ 2,813	
		30 1/4"	10 1/8"	72"	8 1/2"	4	5			\$ 2,513	
		31 1/4"	12 1/8"	72"	10 1/2"	4	5			\$ 2,863	
		30 1/4"	12 1/8"	72"	10 1/2"	4	5			\$ 2,550	
		37 1/4"	10 1/8"	72"	8 1/2"	4	5	115 Lbs.	7 Cu Ft	\$ 2,669	
		36 1/4"	10 1/8"	72"	8 1/2"	4	5	96.6 Lbs.	7 Cu Ft	\$ 2,363	
		37 1/4"	12 1/8"	72"	10 1/2"	4	5	131 Lbs.	8 Cu Ft	\$ 2,719	
		36 1/4"	12 1/8"	72"	10 1/2"	4	5	109 Lbs.	8 Cu Ft	\$ 2,406	
		25 1/4"	10 1/8"	82"	8 1/2"	5	6			\$ 2,894	
		24 1/4"	10 1/8"	82"	8 1/2"	5	6			\$ 2,600	
		25 1/4"	12 1/8"	82"	10 1/2"	5	6			\$ 2,956	
		24 1/4"	12 1/8"	82"	10 1/2"	5	6			\$ 2,644	
		31 1/4"	10 1/8"	82"	8 1/2"	5	6			\$ 2,894	
		30 1/4"	10 1/8"	82"	8 1/2"	5	6			\$ 2,600	
		31 1/4"	12 1/8"	82"	10 1/2"	5	6			\$ 2,956	
		30 1/4"	12 1/8"	82"	10 1/2"	5	6			\$ 2,644	
		37 1/4"	10 1/8"	82"	8 1/2"	5	6	129 Lbs.	8 Cu Ft	\$ 2,756	
		36 1/4"	10 1/8"	82"	8 1/2"	5	6	107 Lbs.	7 Cu Ft	\$ 2,456	
		37 1/4"	12 1/8"	82"	10 1/2"	5	6	145 Lbs.	9 Cu Ft	\$ 2,806	
		36 1/4"	12 1/8"	82"	10 1/2"	5	6	122 Lbs.	8 Cu Ft	\$ 2,494	



Model Shown
DM-7212-S-36-WG



Model Shown
DM-7212-A-36-WG



Model Shown
DM-8212-S-36-WG



Model Shown
DM-8212-A-36-WG

SHELVING

MODEL NUMBER	PRODUCT	WIDTH	DEPTH	HEIGHT	SHELF DEPTH	# OF SHELVES	# OF OPENINGS	WEIGHT	VOLUME	LIST PRICE	DESCRIPTION
DM-9610-S-24-WG	Single Face Starter	25 1/4"	10 1/8"	96"	8 1/2"	6	7			\$ 2,975	End, Mid, Top and Base Panels to be constructed from 1" thick 11-ply solid core, veneered 2 sides. Vertical, top and bottom edges banded with 1/4" external hardwood edging, edges to be eased. Front Edge: 3/4" thick x 2 1/2" high fascia - tongue and grooved to top.
DM-9610-A-24-WG	Single Face Adder	24 1/4"	10 1/8"	96"	8 1/2"	6	7			\$ 2,675	
DM-9612-S-24-WG	Single Face Starter	25 1/4"	12 1/8"	96"	10 1/2"	6	7			\$ 3,044	
DM-9612-A-24-WG	Single Face Adder	24 1/4"	12 1/8"	96"	10 1/2"	6	7			\$ 2,731	
DM-9610-S-30-WG	Single Face Starter	31 1/4"	10 1/8"	96"	8 1/2"	6	7			\$ 2,975	
DM-9610-A-30-WG	Single Face Adder	30 1/4"	10 1/8"	96"	8 1/2"	6	7			\$ 2,675	
DM-9612-S-30-WG	Single Face Starter	31 1/4"	12 1/8"	96"	10 1/2"	6	7			\$ 3,044	
DM-9612-A-30-WG	Single Face Adder	30 1/4"	12 1/8"	96"	10 1/2"	6	7			\$ 2,731	
DM-9610-S-36-WG	Single Face Starter	37 1/4"	10 1/8"	96"	8 1/2"	6	7	156 Lbs.	9 Cu Ft	\$ 2,831	
DM-9610-A-36-WG	Single Face Adder	36 1/4"	10 1/8"	96"	8 1/2"	6	7	128 Lbs.	8 Cu Ft	\$ 2,531	
DM-9612-S-36-WG	Single Face Starter	37 1/4"	12 1/8"	96"	10 1/2"	6	7	177 Lbs.	10 Cu Ft	\$ 2,894	
DM-9612-A-36-WG	Single Face Adder	36 1/4"	12 1/8"	96"	10 1/2"	6	7	145 Lbs.	9 Cu Ft	\$ 2,581	



Model Shown
DM-9612-S-36-WG



Model Shown
DM-9612-A-36-WG

SHELVING

MODEL NUMBER	PRODUCT	WIDTH	DEPTH	HEIGHT	SHELF DEPTH	# OF SHELVES	# OF OPENINGS	WEIGHT	VOLUME	LIST PRICE	DESCRIPTION
--------------	---------	-------	-------	--------	-------------	--------------	---------------	--------	--------	------------	-------------



Model Shown
DM-3624-S-36-WG

DM-3620-S-24-WG	Double Face Starter	25 1/4"	19 1/2"	36"	8 1/2"	2	4			\$ 3,938	End, Mid, Top and Base Panels to be constructed from 1" thick 11-ply solid core, veneered 2 sides. Vertical, top and bottom edges banded with 1/4" external hardwood edging, edges to be eased. Front Edge: 3/4" thick x 2 1/2" high fascia - tongue and grooved to top.
DM-3620-A-24-WG	Double Face Adder	24 1/4"	19 1/2"	36"	8 1/2"	2	4			\$ 3,419	
DM-3624-S-24-WG	Double Face Starter	25 1/4"	23 1/2"	36"	10 1/2"	2	4			\$ 3,969	
DM-3624-A-24-WG	Double Face Adder	24 1/4"	23 1/2"	36"	10 1/2"	2	4			\$ 3,438	
DM-3620-S-30-WG	Double Face Starter	31 1/4"	19 1/2"	36"	8 1/2"	2	4			\$ 3,938	
DM-3620-A-30-WG	Double Face Adder	30 1/4"	19 1/2"	36"	8 1/2"	2	4			\$ 3,419	
DM-3624-S-30-WG	Double Face Starter	31 1/4"	23 1/2"	36"	10 1/2"	2	4			\$ 3,969	
DM-3624-A-30-WG	Double Face Adder	30 1/4"	23 1/2"	36"	10 1/2"	2	4			\$ 3,438	
DM-3620-S-36-WG	Double Face Starter	37 1/4"	19 1/2"	36"	8 1/2"	2	4	88.6 Lbs.	7 Cu Ft	\$ 3,719	
DM-3620-A-36-WG	Double Face Adder	36 1/4"	19 1/2"	36"	8 1/2"	2	4	73.6 Lbs.	6 Cu Ft	\$ 3,194	
DM-3624-S-36-WG	Double Face Starter	37 1/4"	23 1/2"	36"	10 1/2"	2	4	110 Lbs.	10 Cu Ft	\$ 3,750	
DM-3624-A-36-WG	Double Face Adder	36 1/4"	23 1/2"	36"	10 1/2"	2	4	88.6 Lbs.	9 Cu Ft	\$ 3,219	



Model Shown
DM-3624-A-36-WG



Model Shown
DM-4224-S-36-WG





DM-4220-S-24-WG	Double Face Starter	25 1/4"	19 1/2"	42"	8 1/2"	4	6			\$ 4,106	End, Mid, Top and Base Panels to be constructed from 1" thick 11-ply solid core, veneered 2 sides. Vertical, top and bottom edges banded with 1/4" external hardwood edging, edges to be eased. Front Edge: 3/4" thick x 2 1/2" high fascia - tongue and grooved to top.
DM-4220-A-24-WG	Double Face Adder	24 1/4"	19 1/2"	42"	8 1/2"	4	6			\$ 3,588	
DM-4224-S-24-WG	Double Face Starter	25 1/4"	23 1/2"	42"	10 1/2"	4	6			\$ 4,150	
DM-4224-A-24-WG	Double Face Adder	24 1/4"	23 1/2"	42"	10 1/2"	4	6			\$ 3,613	
DM-4220-S-30-WG	Double Face Starter	31 1/4"	19 1/2"	42"	8 1/2"	4	6			\$ 4,106	
DM-4220-A-30-WG	Double Face Adder	30 1/4"	19 1/2"	42"	8 1/2"	4	6			\$ 3,588	
DM-4224-S-30-WG	Double Face Starter	31 1/4"	23 1/2"	42"	10 1/2"	4	6			\$ 4,150	
DM-4224-A-30-WG	Double Face Adder	30 1/4"	23 1/2"	42"	10 1/2"	4	6			\$ 3,613	







Model Shown
DM-4224-A-36-WG

DM-4220-S-36-WG	Double Face Starter	37 1/4"	19 1/2"	42"	8 1/2"	4	6	94 Lbs.	7 Cu Ft	\$ 3,888
DM-4220-A-36-WG	Double Face Adder	36 1/4"	19 1/2"	42"	8 1/2"	4	6	78 Lbs.	7 Cu Ft	\$ 3,363
DM-4224-S-36-WG	Double Face Starter	37 1/4"	23 1/2"	42"	10 1/2"	4	6	115 Lbs.	10 Cu Ft	\$ 3,931
DM-4224-A-36-WG	Double Face Adder	36 1/4"	23 1/2"	42"	10 1/2"	4	6	113 Lbs.	10 Cu Ft	\$ 3,394

SHELVING

		MODEL NUMBER	PRODUCT	WIDTH	DEPTH	HEIGHT	SHELF DEPTH	# OF SHELVES	# OF OPENINGS	WEIGHT	VOLUME	LIST PRICE	DESCRIPTION
 <p>Model Shown DM-4224-S-36-WG</p>		DM-4820-S-24-WG	Double Face Starter	25 1/4"	19 1/2"	48"	8 1/2"	4	6			\$ 4,306	End, Mid, Top and Base Panels to be constructed from 1" thick 11-ply solid core, veneered 2 sides. Vertical, top and bottom edges banded with 1/4" external hardwood edging, edges to be eased. Front Edge: 3/4" thick x 2 1/2" high fascia - tongue and grooved to top.
		DM-4820-A-24-WG	Double Face Adder	24 1/4"	19 1/2"	48"	8 1/2"	4	6			\$ 3,769	
		DM-4824-S-24-WG	Double Face Starter	25 1/4"	23 1/2"	48"	10 1/2"	4	6			\$ 4,356	
		DM-4824-A-24-WG	Double Face Adder	24 1/4"	23 1/2"	48"	10 1/2"	4	6			\$ 3,794	
 <p>Model Shown DM-4224-A-36-WG</p>		DM-4820-S-30-WG	Double Face Starter	31 1/4"	19 1/2"	48"	8 1/2"	4	6			\$ 4,306	
		DM-4820-A-30-WG	Double Face Adder	30 1/4"	19 1/2"	48"	8 1/2"	4	6			\$ 3,769	
		DM-4824-S-30-WG	Double Face Starter	31 1/4"	23 1/2"	48"	10 1/2"	4	6			\$ 4,356	
		DM-4824-A-30-WG	Double Face Adder	30 1/4"	23 1/2"	48"	10 1/2"	4	6			\$ 3,794	
 <p>Model Shown DM-6024-S-36-WG</p>		DM-4820-S-36-WG	Double Face Starter	37 1/4"	19 1/2"	48"	8 1/2"	4	6	132 Lbs.	9 Cu Ft	\$ 4,081	
		DM-4820-A-36-WG	Double Face Adder	36 1/4"	19 1/2"	48"	8 1/2"	4	6	109 Lbs.	8 Cu Ft	\$ 3,531	
		DM-4824-S-36-WG	Double Face Starter	37 1/4"	23 1/2"	48"	10 1/2"	4	6	155 Lbs.	11 Cu Ft	\$ 4,125	
		DM-4824-A-36-WG	Double Face Adder	36 1/4"	23 1/2"	48"	10 1/2"	4	6	127 Lbs.	10 Cu Ft	\$ 3,569	
 <p>Model Shown DM-6024-S-36-WG</p>		DM-6020-S-24-WG	Double Face Starter	25 1/4"	19 1/2"	60"	8 1/2"	6	8			\$ 5,481	
		DM-6020-A-24-WG	Double Face Adder	24 1/4"	19 1/2"	60"	8 1/2"	6	8			\$ 4,938	
		DM-6024-S-24-WG	Double Face Starter	25 1/4"	23 1/2"	60"	10 1/2"	6	8			\$ 5,525	
		DM-6024-A-24-WG	Double Face Adder	24 1/4"	23 1/2"	60"	10 1/2"	6	8			\$ 4,981	
 <p>Model Shown DM-6024-A-36-WG</p>		DM-6020-S-30-WG	Double Face Starter	31 1/4"	19 1/2"	60"	8 1/2"	6	8			\$ 5,481	
		DM-6020-A-30-WG	Double Face Adder	30 1/4"	19 1/2"	60"	8 1/2"	6	8			\$ 4,938	
		DM-6024-S-30-WG	Double Face Starter	31 1/4"	23 1/2"	60"	10 1/2"	6	8			\$ 5,525	
		DM-6024-A-30-WG	Double Face Adder	30 1/4"	23 1/2"	60"	10 1/2"	6	8			\$ 4,981	
		DM-6020-S-36-WG	Double Face Starter	37 1/4"	19 1/2"	60"	8 1/2"	6	8	176 Lbs.	11 Cu Ft	\$ 5,256	
		DM-6020-A-36-WG	Double Face Adder	36 1/4"	19 1/2"	60"	8 1/2"	6	8	145 Lbs.	10 Cu Ft	\$ 4,725	
		DM-6024-S-36-WG	Double Face Starter	37 1/4"	23 1/2"	60"	10 1/2"	6	8	200 Lbs.	12 Cu Ft	\$ 5,306	
		DM-6024-A-36-WG	Double Face Adder	36 1/4"	23 1/2"	60"	10 1/2"	6	8	164 Lbs.	11 Cu Ft	\$ 4,763	

SHELVING

MODEL NUMBER	PRODUCT	WIDTH	DEPTH	HEIGHT	SHELF DEPTH	# OF SHELVES	# OF OPENINGS	WEIGHT	VOLUME	LIST PRICE	DESCRIPTION	
 Model Shown DM-7224-S-36-WG  Model Shown DM-7224-A-36-WG  Model Shown DM-8224-S-36-WG  Model Shown DM-8224-A-36-WG	DM-7220-S-24-WG	Double Face Starter	25 1/4"	19 1/2"	72"	8 1/2"	8			\$ 5,644	End, Mid, Top and Base Panels to be constructed from 1" thick 11-ply solid core, veneered 2 sides. Vertical, top and bottom edges banded with 1/4" external hardwood edging, edges to be eased. Front Edge: 3/4" thick x 2 1/2" high fascia - tongue and grooved to top.	
	DM-7220-A-24-WG	Double Face Adder	24 1/4"	19 1/2"	72"	8 1/2"	8			\$ 5,106		
	DM-7224-S-24-WG	Double Face Starter	25 1/4"	23 1/2"	72"	10 1/2"	8			\$ 5,700		
	DM-7224-A-24-WG	Double Face Adder	24 1/4"	23 1/2"	72"	10 1/2"	8			\$ 5,156		
	DM-7220-S-30-WG	Double Face Starter	31 1/4"	19 1/2"	72"	8 1/2"	8			\$ 5,644		
	DM-7220-A-30-WG	Double Face Adder	30 1/4"	19 1/2"	72"	8 1/2"	8			\$ 5,106		
	DM-7224-S-30-WG	Double Face Starter	31 1/4"	23 1/2"	72"	10 1/2"	8			\$ 5,700		
	DM-7224-A-30-WG	Double Face Adder	30 1/4"	23 1/2"	72"	10 1/2"	8			\$ 5,156		
	DM-7220-S-36-WG	Double Face Starter	37 1/4"	19 1/2"	72"	8 1/2"	8	10	200 Lbs.	12 Cu Ft		\$ 5,431
	DM-7220-A-36-WG	Double Face Adder	36 1/4"	19 1/2"	72"	8 1/2"	8	10	164 Lbs.	11 Cu Ft		\$ 4,888
	DM-7224-S-36-WG	Double Face Starter	37 1/4"	23 1/2"	72"	10 1/2"	8	10	229 Lbs.	13 Cu Ft		\$ 5,481
	DM-7224-A-36-WG	Double Face Adder	36 1/4"	23 1/2"	72"	10 1/2"	8	10	186 Lbs.	12 Cu Ft		\$ 4,938
	DM-8220-S-24-WG	Double Face Starter	25 1/4"	19 1/2"	82"	8 1/2"	10	12				\$ 5,806
	DM-8220-A-24-WG	Double Face Adder	24 1/4"	19 1/2"	82"	8 1/2"	10	12				\$ 5,275
	DM-8224-S-24-WG	Double Face Starter	25 1/4"	23 1/2"	82"	10 1/2"	10	12				\$ 5,869
	DM-8224-A-24-WG	Double Face Adder	24 1/4"	23 1/2"	82"	10 1/2"	10	12				\$ 5,344
DM-8220-S-30-WG	Double Face Starter	31 1/4"	19 1/2"	82"	8 1/2"	10	12			\$ 5,806		
DM-8220-A-30-WG	Double Face Adder	30 1/4"	19 1/2"	82"	8 1/2"	10	12			\$ 5,275		
DM-8224-S-30-WG	Double Face Starter	31 1/4"	23 1/2"	82"	10 1/2"	10	12			\$ 5,869		
DM-8224-A-30-WG	Double Face Adder	30 1/4"	23 1/2"	82"	10 1/2"	10	12			\$ 5,344		
DM-8220-S-36-WG	Double Face Starter	37 1/4"	19 1/2"	82"	8 1/2"	10	12	224 Lbs.	12 Cu Ft	\$ 5,588		
DM-8220-A-36-WG	Double Face Adder	36 1/4"	19 1/2"	82"	8 1/2"	10	12	184 Lbs.	11 Cu Ft	\$ 5,056		
DM-8224-S-36-WG	Double Face Starter	37 1/4"	23 1/2"	82"	10 1/2"	10	12	256 Lbs.	14 Cu Ft	\$ 5,644		
DM-8224-A-36-WG	Double Face Adder	36 1/4"	23 1/2"	82"	10 1/2"	10	12	207 Lbs.	12 Cu Ft	\$ 5,119		





MODEL NUMBER	PRODUCT	WIDTH	DEPTH	HEIGHT	SHELF DEPTH	# OF SHELVES	# OF OPENINGS	WEIGHT	VOLUME	LIST PRICE	DESCRIPTION
DM-9620-S-24-WG	Double Face Starter	25 1/4"	19 1/2"	96"	8 1/2"	12	14			\$ 5,969	End, Mid, Top and Base Panels to be constructed from 1" thick 11-ply solid core, veneered 2 sides. Vertical, top and bottom edges banded with 1/4" external hardwood edging, edges to be eased. Front Edge: 3/4" thick x 2 1/2" high fascia - tongue and grooved to top.
DM-9620-A-24-WG	Double Face Adder	24 1/4"	19 1/2"	96"	8 1/2"	12	14			\$ 5,438	
DM-9624-S-24-WG	Double Face Starter	25 1/4"	23 1/2"	96"	10 1/2"	12	14			\$ 6,044	
DM-9624-A-24-WG	Double Face Adder	24 1/4"	23 1/2"	96"	10 1/2"	12	14			\$ 5,519	
DM-9620-S-30-WG	Double Face Starter	31 1/4"	19 1/2"	96"	8 1/2"	12	14			\$ 5,969	
DM-9620-A-30-WG	Double Face Adder	30 1/4"	19 1/2"	96"	8 1/2"	12	14			\$ 5,438	
DM-9624-S-30-WG	Double Face Starter	31 1/4"	23 1/2"	96"	10 1/2"	12	14			\$ 6,044	
DM-9624-A-30-WG	Double Face Adder	30 1/4"	23 1/2"	96"	10 1/2"	12	14			\$ 5,519	
DM-9620-S-36-WG	Double Face Starter	37 1/4"	19 1/2"	96"	8 1/2"	12	14	276 Lbs.	13 Cu Ft	\$ 5,756	
DM-9620-A-36-WG	Double Face Adder	36 1/4"	19 1/2"	96"	8 1/2"	12	14	220 Lbs.	12 Cu Ft	\$ 5,219	
DM-9624-S-36-WG	Double Face Starter	37 1/4"	23 1/2"	96"	10 1/2"	12	14	315 Lbs.	15 Cu Ft	\$ 5,831	
DM-9624-A-36-WG	Double Face Adder	36 1/4"	23 1/2"	96"	10 1/2"	12	14	247 Lbs.	13 Cu Ft	\$ 5,294	







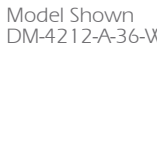

Model Shown
DM-9624-S-36-WG





Model Shown
DM-9624-A-36-WG

	MODEL NUMBER	PRODUCT	WIDTH	DEPTH	HEIGHT	SHELF DEPTH	# OF SHELVES	# OF OPENINGS	WEIGHT	VOLUME	LIST PRICE	DESCRIPTION
	DM-3610-S-24-WH	Single Face Starter	25 1/4"	10 1/8"	36"	8 1/2"	1	2			\$ 2,038	End, Mid, Top and Base Panels to be constructed from 1" thick 11-ply solid core, veneered 2 sides. Vertical, top and bottom edges banded with 1/4" external hardwood edging, edges to be eased. Front Edge: 3/4" thick x 2 1/2" high fascia - tongue and grooved to top.
	DM-3610-A-24-WH	Single Face Adder	24 1/4"	10 1/8"	36"	8 1/2"	1	2			\$ 1,738	
	DM-3612-S-24-WH	Single Face Starter	25 1/4"	12 1/8"	36"	10 1/2"	1	2			\$ 2,075	
	DM-3612-A-24-WH	Single Face Adder	24 1/4"	12 1/8"	36"	10 1/2"	1	2			\$ 1,769	
	DM-3610-S-30-WH	Single Face Starter	31 1/4"	10 1/8"	36"	8 1/2"	1	2			\$ 2,038	
	DM-3610-A-30-WH	Single Face Adder	30 1/4"	10 1/8"	36"	8 1/2"	1	2			\$ 1,738	
	DM-3612-S-30-WH	Single Face Starter	31 1/4"	12 1/8"	36"	10 1/2"	1	2			\$ 2,075	
	DM-3612-A-30-WH	Single Face Adder	30 1/4"	12 1/8"	36"	10 1/2"	1	2			\$ 1,769	
	DM-3610-S-36-WH	Single Face Starter	37 1/4"	10 1/8"	36"	8 1/2"	1	2	50.6 Lbs.	4 Cu Ft	\$ 1,894	
	DM-3610-A-36-WH	Single Face Adder	36 1/4"	10 1/8"	36"	8 1/2"	1	2	46 Lbs.	4 Cu Ft	\$ 1,594	
	DM-3612-S-36-WH	Single Face Starter	37 1/4"	12 1/8"	36"	10 1/2"	1	2	50.6 Lbs.	5 Cu Ft	\$ 1,931	
	DM-3612-A-36-WH	Single Face Adder	36 1/4"	12 1/8"	36"	10 1/2"	1	2	47.2 Lbs.	5 Cu Ft	\$ 1,619	
	DM-4210-S-24-WH	Single Face Starter	25 1/4"	10 1/8"	42"	8 1/2"	2	3			\$ 2,125	
	DM-4210-A-24-WH	Single Face Adder	24 1/4"	10 1/8"	42"	8 1/2"	2	3			\$ 1,831	
	DM-4212-S-24-WH	Single Face Starter	25 1/4"	12 1/8"	42"	10 1/2"	2	3			\$ 2,169	
	DM-4212-A-24-WH	Single Face Adder	24 1/4"	12 1/8"	42"	10 1/2"	2	3			\$ 1,856	
	DM-4210-S-30-WH	Single Face Starter	31 1/4"	10 1/8"	42"	8 1/2"	2	3			\$ 2,125	
	DM-4210-A-30-WH	Single Face Adder	30 1/4"	10 1/8"	42"	8 1/2"	2	3			\$ 1,831	
	DM-4212-S-30-WH	Single Face Starter	31 1/4"	12 1/8"	42"	10 1/2"	2	3			\$ 2,169	
	DM-4212-A-30-WH	Single Face Adder	30 1/4"	12 1/8"	42"	10 1/2"	2	3			\$ 1,856	
	DM-4210-S-36-WH	Single Face Starter	37 1/4"	10 1/8"	42"	8 1/2"	2	3	55 Lbs.	5 Cu Ft	\$ 1,975	
	DM-4210-A-36-WH	Single Face Adder	36 1/4"	10 1/8"	42"	8 1/2"	2	3	52 Lbs.	5 Cu Ft	\$ 1,688	
	DM-4212-S-36-WH	Single Face Starter	37 1/4"	12 1/8"	42"	10 1/2"	2	3	60 Lbs.	5 Cu Ft	\$ 2,019	
	DM-4212-A-36-WH	Single Face Adder	36 1/4"	12 1/8"	42"	10 1/2"	2	3	53 Lbs.	5 Cu Ft	\$ 1,706	

	MODEL NUMBER	PRODUCT	WIDTH	DEPTH	HEIGHT	SHELF DEPTH	# OF SHELVES	# OF OPENINGS	WEIGHT	VOLUME	LIST PRICE	DESCRIPTION
 <p>Model Shown DM-4212-S-36-WH</p>	DM-4810-S-24-WH	Single Face Starter	25 1/4"	10 1/8"	48"	8 1/2"	2	3			\$ 2,181	End, Mid, Top and Base Panels to be constructed from 1" thick 11-ply solid core, veneered 2 sides. Vertical, top and bottom edges banded with 1/4" external hardwood edging, edges to be eased. Front Edge: 3/4" thick x 2 1/2" high fascia - tongue and grooved to top.
	DM-4810-A-24-WH	Single Face Adder	24 1/4"	10 1/8"	48"	8 1/2"	2	3			\$ 1,875	
	DM-4812-S-24-WH	Single Face Starter	25 1/4"	12 1/8"	48"	10 1/2"	2	3			\$ 2,200	
	DM-4812-A-24-WH	Single Face Adder	24 1/4"	12 1/8"	48"	10 1/2"	2	3			\$ 1,875	
 <p>Model Shown DM-4212-A-36-WH</p>	DM-4810-S-30-WH	Single Face Starter	31 1/4"	10 1/8"	48"	8 1/2"	2	3			\$ 2,181	
	DM-4810-A-30-WH	Single Face Adder	30 1/4"	10 1/8"	48"	8 1/2"	2	3			\$ 1,875	
	DM-4812-S-30-WH	Single Face Starter	31 1/4"	12 1/8"	48"	10 1/2"	2	3			\$ 2,200	
	DM-4812-A-30-WH	Single Face Adder	30 1/4"	12 1/8"	48"	10 1/2"	2	3			\$ 1,875	
 <p>Model Shown DM-4212-A-36-WH</p>	DM-4810-S-36-WH	Single Face Starter	37 1/4"	10 1/8"	48"	8 1/2"	2	3	74.8 Lbs.	5 Cu Ft	\$ 2,038	
	DM-4810-A-36-WH	Single Face Adder	36 1/4"	10 1/8"	48"	8 1/2"	2	3	65.5 Lbs.	5 Cu Ft	\$ 1,725	
	DM-4812-S-36-WH	Single Face Starter	37 1/4"	12 1/8"	48"	10 1/2"	2	3	82.8 Lbs.	6 Cu Ft	\$ 2,050	
	DM-4812-A-36-WH	Single Face Adder	36 1/4"	12 1/8"	48"	10 1/2"	2	3	71.3 Lbs.	6 Cu Ft	\$ 1,725	
 <p>Model Shown DM-6012-S-36-WH</p>	DM-6010-S-24-WH	Single Face Starter	25 1/4"	10 1/8"	60"	8 1/2"	3	4			\$ 2,369	
	DM-6010-A-24-WH	Single Face Adder	24 1/4"	10 1/8"	60"	8 1/2"	3	4			\$ 2,075	
	DM-6012-S-24-WH	Single Face Starter	25 1/4"	12 1/8"	60"	10 1/2"	3	4			\$ 2,419	
	DM-6012-A-24-WH	Single Face Adder	24 1/4"	12 1/8"	60"	10 1/2"	3	4			\$ 2,106	
 <p>Model Shown DM-6012-A-36-WH</p>	DM-6010-S-30-WH	Single Face Starter	31 1/4"	10 1/8"	60"	8 1/2"	3	4			\$ 2,369	
	DM-6010-A-30-WH	Single Face Adder	30 1/4"	10 1/8"	60"	8 1/2"	3	4			\$ 2,075	
	DM-6012-S-30-WH	Single Face Starter	31 1/4"	12 1/8"	60"	10 1/2"	3	4			\$ 2,419	
	DM-6012-A-30-WH	Single Face Adder	30 1/4"	12 1/8"	60"	10 1/2"	3	4			\$ 2,106	
 <p>Model Shown DM-6012-A-36-WH</p>	DM-6010-S-36-WH	Single Face Starter	37 1/4"	10 1/8"	60"	8 1/2"	3	4	100 Lbs.	6 Cu Ft	\$ 2,225	
	DM-6010-A-36-WH	Single Face Adder	36 1/4"	10 1/8"	60"	8 1/2"	3	4	86.3 Lbs.	6 Cu Ft	\$ 1,931	
	DM-6012-S-36-WH	Single Face Starter	37 1/4"	12 1/8"	60"	10 1/2"	3	4	116 Lbs.	8 Cu Ft	\$ 2,269	
	DM-6012-A-36-WH	Single Face Adder	36 1/4"	12 1/8"	60"	10 1/2"	3	4	95.5 Lbs.	7 Cu Ft	\$ 1,375	

SHELVING

MODEL NUMBER	PRODUCT	WIDTH	DEPTH	HEIGHT	SHELF DEPTH	# OF SHELVES	# OF OPENINGS	WEIGHT	VOLUME	LIST PRICE	DESCRIPTION	
 Model Shown DM-7212-S-36-WH	DM-7210-S-24-WH	Single Face Starter	25 1/4"	10 1/8"	72"	8 1/2"	4			\$ 2,456	End, Mid, Top and Base Panels to be constructed from 1" thick 11-ply solid core, veneered 2 sides. Vertical, top and bottom edges banded with 1/4" external hardwood edging, edges to be eased. Front Edge: 3/4" thick x 2 1/2" high fascia - tongue and grooved to top.	
	DM-7210-A-24-WH	Single Face Adder	24 1/4"	10 1/8"	72"	8 1/2"	4			\$ 2,156		
	DM-7212-S-24-WH	Single Face Starter	25 1/4"	12 1/8"	72"	10 1/2"	4			\$ 2,513		
	DM-7212-A-24-WH	Single Face Adder	24 1/4"	12 1/8"	72"	10 1/2"	4			\$ 2,200		
	DM-7210-S-30-WH	Single Face Starter	31 1/4"	10 1/8"	72"	8 1/2"	4			\$ 2,456		
	DM-7210-A-30-WH	Single Face Adder	30 1/4"	10 1/8"	72"	8 1/2"	4			\$ 2,156		
	DM-7212-S-30-WH	Single Face Starter	31 1/4"	12 1/8"	72"	10 1/2"	4			\$ 2,513		
	DM-7212-A-30-WH	Single Face Adder	30 1/4"	12 1/8"	72"	10 1/2"	4			\$ 2,194		
	DM-7210-S-36-WH	Single Face Starter	37 1/4"	10 1/8"	72"	8 1/2"	4		115 Lbs.	7 Cu Ft		\$ 2,313
	DM-7210-A-36-WH	Single Face Adder	36 1/4"	10 1/8"	72"	8 1/2"	4		96.6 Lbs.	7 Cu Ft		\$ 2,013
	DM-7212-S-36-WH	Single Face Starter	37 1/4"	12 1/8"	72"	10 1/2"	4		131 Lbs.	8 Cu Ft		\$ 2,363
	DM-7212-A-36-WH	Single Face Adder	36 1/4"	12 1/8"	72"	10 1/2"	4		109 Lbs.	8 Cu Ft		\$ 2,050
 Model Shown DM-8212-S-36-WH	DM-8210-S-24-WH	Single Face Starter	25 1/4"	10 1/8"	82"	8 1/2"	5			\$ 2,538		
	DM-8210-A-24-WH	Single Face Adder	24 1/4"	10 1/8"	82"	8 1/2"	5			\$ 2,238		
	DM-8212-S-24-WH	Single Face Starter	25 1/4"	12 1/8"	82"	10 1/2"	5			\$ 2,600		
	DM-8212-A-24-WH	Single Face Adder	24 1/4"	12 1/8"	82"	10 1/2"	5			\$ 2,288		
	DM-8210-S-30-WH	Single Face Starter	31 1/4"	10 1/8"	82"	8 1/2"	5			\$ 2,538		
	DM-8210-A-30-WH	Single Face Adder	30 1/4"	10 1/8"	82"	8 1/2"	5			\$ 2,238		
	DM-8212-S-30-WH	Single Face Starter	31 1/4"	12 1/8"	82"	10 1/2"	5			\$ 2,600		
	DM-8212-A-30-WH	Single Face Adder	30 1/4"	12 1/8"	82"	10 1/2"	5			\$ 2,288		
	DM-8210-S-36-WH	Single Face Starter	37 1/4"	10 1/8"	82"	8 1/2"	5		129 Lbs.	8 Cu Ft	\$ 2,394	
	DM-8210-A-36-WH	Single Face Adder	36 1/4"	10 1/8"	82"	8 1/2"	5		107 Lbs.	7 Cu Ft	\$ 2,094	
	DM-8212-S-36-WH	Single Face Starter	37 1/4"	12 1/8"	82"	10 1/2"	5		145 Lbs.	9 Cu Ft	\$ 2,450	
	DM-8212-A-36-WH	Single Face Adder	36 1/4"	12 1/8"	82"	10 1/2"	5		122 Lbs.	8 Cu Ft	\$ 2,144	

MODEL NUMBER	PRODUCT	WIDTH	DEPTH	HEIGHT	SHELF DEPTH	# OF SHELVES	# OF OPENINGS	WEIGHT	VOLUME	LIST PRICE	DESCRIPTION
DM-9610-S-24-WH	Single Face Starter	25 1/4"	10 1/8"	96"	8 1/2"	6	7			\$ 2,619	End, Mid, Top and Base Panels to be constructed from 1" thick 11-ply solid core, veneered 2 sides. Vertical, top and bottom edges banded with 1/4" external hardwood edging, edges to be eased. Front Edge: 3/4" thick x 2 1/2" high fascia - tongue and grooved to top.
DM-9610-A-24-WH	Single Face Adder	24 1/4"	10 1/8"	96"	8 1/2"	6	7			\$ 2,325	
DM-9612-S-24-WH	Single Face Starter	25 1/4"	12 1/8"	96"	10 1/2"	6	7			\$ 2,688	
DM-9612-A-24-WH	Single Face Adder	24 1/4"	12 1/8"	96"	10 1/2"	6	7			\$ 2,369	
DM-9610-S-30-WH	Single Face Starter	31 1/4"	10 1/8"	96"	8 1/2"	6	7			\$ 2,619	
DM-9610-A-30-WH	Single Face Adder	30 1/4"	10 1/8"	96"	8 1/2"	6	7			\$ 2,325	
DM-9612-S-30-WH	Single Face Starter	31 1/4"	12 1/8"	96"	10 1/2"	6	7			\$ 2,688	
DM-9612-A-30-WH	Single Face Adder	30 1/4"	12 1/8"	96"	10 1/2"	6	7			\$ 2,369	
DM-9610-S-36-WH	Single Face Starter	37 1/4"	10 1/8"	96"	8 1/2"	6	7	156 Lbs.	9 Cu Ft	\$ 2,475	
DM-9610-A-36-WH	Single Face Adder	36 1/4"	10 1/8"	96"	8 1/2"	6	7	128 Lbs.	8 Cu Ft	\$ 2,175	
DM-9612-S-36-WH	Single Face Starter	37 1/4"	12 1/8"	96"	10 1/2"	6	7	177 Lbs.	10 Cu Ft	\$ 2,544	
DM-9612-A-36-WH	Single Face Adder	36 1/4"	12 1/8"	96"	10 1/2"	6	7	145 Lbs.	9 Cu Ft	\$ 2,225	



Model Shown
DM-9612-S-36-WH



Model Shown
DM-9612-A-36-WH

SHELVING

MODEL NUMBER	PRODUCT	WIDTH	DEPTH	HEIGHT	SHELF DEPTH	# OF SHELVES	# OF OPENINGS	WEIGHT	VOLUME	LIST PRICE	DESCRIPTION
--------------	---------	-------	-------	--------	-------------	--------------	---------------	--------	--------	------------	-------------



Model Shown
DM-3624-S-36-WH



Model Shown
DM-3624-A-36-WH

DM-3620-S-24-WH	Double Face Starter	25 1/4"	19 1/2"	36"	8 1/2"	2	4			\$ 3,819	End, Mid, Top and Base Panels to be constructed from 1" thick 11-ply solid core, veneered 2 sides. Vertical, top and bottom edges banded with 1/4" external hardwood edging, edges to be eased. Front Edge: 3/4" thick x 2 1/2" high fascia - tongue and grooved to top.
DM-3620-A-24-WH	Double Face Adder	24 1/4"	19 1/2"	36"	8 1/2"	2	4			\$ 3,306	
DM-3624-S-24-WH	Double Face Starter	25 1/4"	23 1/2"	36"	10 1/2"	2	4			\$ 3,856	
DM-3624-A-24-WH	Double Face Adder	24 1/4"	23 1/2"	36"	10 1/2"	2	4			\$ 3,325	
DM-3620-S-30-WH	Double Face Starter	31 1/4"	19 1/2"	36"	8 1/2"	2	4			\$ 3,819	
DM-3620-A-30-WH	Double Face Adder	30 1/4"	19 1/2"	36"	8 1/2"	2	4			\$ 3,306	
DM-3624-S-30-WH	Double Face Starter	31 1/4"	23 1/2"	36"	10 1/2"	2	4			\$ 3,856	
DM-3624-A-30-WH	Double Face Adder	30 1/4"	23 1/2"	36"	10 1/2"	2	4			\$ 3,325	
DM-3620-S-36-WH	Double Face Starter	37 1/4"	19 1/2"	36"	8 1/2"	2	4	88.6 Lbs.	7 Cu Ft	\$ 3,606	
DM-3620-A-36-WH	Double Face Adder	36 1/4"	19 1/2"	36"	8 1/2"	2	4	73.6 Lbs.	6 Cu Ft	\$ 3,088	
DM-3624-S-36-WH	Double Face Starter	37 1/4"	23 1/2"	36"	10 1/2"	2	4	110 Lbs.	10 Cu Ft	\$ 3,638	
DM-3624-A-36-WH	Double Face Adder	36 1/4"	23 1/2"	36"	10 1/2"	2	4	88.6 Lbs.	9 Cu Ft	\$ 3,106	



Model Shown
DM-4224-S-36-WH



Model Shown
DM-4224-A-36-WH

DM-4220-S-24-WH	Double Face Starter	25 1/4"	19 1/2"	42"	8 1/2"	4	6			\$ 3,994	
DM-4220-A-24-WH	Double Face Adder	24 1/4"	19 1/2"	42"	8 1/2"	4	6			\$ 3,475	
DM-4224-S-24-WH	Double Face Starter	25 1/4"	23 1/2"	42"	10 1/2"	4	6			\$ 4,044	
DM-4224-A-24-WH	Double Face Adder	24 1/4"	23 1/2"	42"	10 1/2"	4	6			\$ 3,500	
DM-4220-S-30-WH	Double Face Starter	31 1/4"	19 1/2"	42"	8 1/2"	4	6			\$ 3,994	
DM-4220-A-30-WH	Double Face Adder	30 1/4"	19 1/2"	42"	8 1/2"	4	6			\$ 3,475	
DM-4224-S-30-WH	Double Face Starter	31 1/4"	23 1/2"	42"	10 1/2"	4	6			\$ 4,044	
DM-4224-A-30-WH	Double Face Adder	30 1/4"	23 1/2"	42"	10 1/2"	4	6			\$ 3,500	
DM-4220-S-36-WH	Double Face Starter	37 1/4"	19 1/2"	42"	8 1/2"	4	6	94 Lbs.	7 Cu Ft	\$ 3,775	
DM-4220-A-36-WH	Double Face Adder	36 1/4"	19 1/2"	42"	8 1/2"	4	6	78 Lbs.	7 Cu Ft	\$ 3,256	
DM-4224-S-36-WH	Double Face Starter	37 1/4"	23 1/2"	42"	10 1/2"	4	6	115 Lbs.	10 Cu Ft	\$ 3,819	
DM-4224-A-36-WH	Double Face Adder	36 1/4"	23 1/2"	42"	10 1/2"	4	6	113 Lbs.	10 Cu Ft	\$ 3,281	

MODEL NUMBER	PRODUCT	WIDTH	DEPTH	HEIGHT	SHELF DEPTH	# OF SHELVES	# OF OPENINGS	WEIGHT	VOLUME	LIST PRICE	DESCRIPTION
--------------	---------	-------	-------	--------	-------------	--------------	---------------	--------	--------	------------	-------------



Model Shown
DM-4224-S-36-WH

DM-4820-S-24-WH	Double Face Starter	25 1/4"	19 1/2"	48"	8 1/2"	4	6			\$ 4,069	End, Mid, Top and Base Panels to be constructed from 1" thick 11-ply solid core, veneered 2 sides. Vertical, top and bottom edges banded with 1/4" external hardwood edging, edges to be eased. Front Edge: 3/4" thick x 2 1/2" high fascia - tongue and grooved to top.
DM-4820-A-24-WH	Double Face Adder	24 1/4"	19 1/2"	48"	8 1/2"	4	6			\$ 3,531	
DM-4824-S-24-WH	Double Face Starter	25 1/4"	23 1/2"	48"	10 1/2"	4	6			\$ 4,113	
DM-4824-A-24-WH	Double Face Adder	24 1/4"	23 1/2"	48"	10 1/2"	4	6			\$ 3,556	
DM-4820-S-30-WH	Double Face Starter	31 1/4"	19 1/2"	48"	8 1/2"	4	6			\$ 4,069	
DM-4820-A-30-WH	Double Face Adder	30 1/4"	19 1/2"	48"	8 1/2"	4	6			\$ 3,531	
DM-4824-S-30-WH	Double Face Starter	31 1/4"	23 1/2"	48"	10 1/2"	4	6			\$ 4,113	
DM-4824-A-30-WH	Double Face Adder	30 1/4"	23 1/2"	48"	10 1/2"	4	6			\$ 3,556	



Model Shown
DM-4224-A-36-WH

DM-4820-S-36-WH	Double Face Starter	37 1/4"	19 1/2"	48"	8 1/2"	4	6	132 Lbs.	9 Cu Ft	\$ 3,844
DM-4820-A-36-WH	Double Face Adder	36 1/4"	19 1/2"	48"	8 1/2"	4	6	109 Lbs.	8 Cu Ft	\$ 3,313
DM-4824-S-36-WH	Double Face Starter	37 1/4"	23 1/2"	48"	10 1/2"	4	6	155 Lbs.	11 Cu Ft	\$ 3,894
DM-4824-A-36-WH	Double Face Adder	36 1/4"	23 1/2"	48"	10 1/2"	4	6	127 Lbs.	10 Cu Ft	\$ 3,331



Model Shown
DM-6024-S-36-WH

DM-6020-S-24-WH	Double Face Starter	25 1/4"	19 1/2"	60"	8 1/2"	6	8			\$ 4,469
DM-6020-A-24-WH	Double Face Adder	24 1/4"	19 1/2"	60"	8 1/2"	6	8			\$ 3,938
DM-6024-S-24-WH	Double Face Starter	25 1/4"	23 1/2"	60"	10 1/2"	6	8			\$ 4,519
DM-6024-A-24-WH	Double Face Adder	24 1/4"	23 1/2"	60"	10 1/2"	6	8			\$ 3,975
DM-6020-S-30-WH	Double Face Starter	31 1/4"	19 1/2"	60"	8 1/2"	6	8			\$ 4,469
DM-6020-A-30-WH	Double Face Adder	30 1/4"	19 1/2"	60"	8 1/2"	6	8			\$ 3,938
DM-6024-S-30-WH	Double Face Starter	31 1/4"	23 1/2"	60"	10 1/2"	6	8			\$ 4,519
DM-6024-A-30-WH	Double Face Adder	30 1/4"	23 1/2"	60"	10 1/2"	6	8			\$ 3,975



Model Shown
DM-6024-A-36-WH

DM-6020-S-36-WH	Double Face Starter	37 1/4"	19 1/2"	60"	8 1/2"	6	8	176 Lbs.	11 Cu Ft	\$ 5,256
DM-6020-A-36-WH	Double Face Adder	36 1/4"	19 1/2"	60"	8 1/2"	6	8	145 Lbs.	10 Cu Ft	\$ 4,725
DM-6024-S-36-WH	Double Face Starter	37 1/4"	23 1/2"	60"	10 1/2"	6	8	200 Lbs.	12 Cu Ft	\$ 5,306
DM-6024-A-36-WH	Double Face Adder	36 1/4"	23 1/2"	60"	10 1/2"	6	8	164 Lbs.	11 Cu Ft	\$ 4,763

SHELVING

MODEL NUMBER	PRODUCT	WIDTH	DEPTH	HEIGHT	SHELF DEPTH	# OF SHELVES	# OF OPENINGS	WEIGHT	VOLUME	LIST PRICE	DESCRIPTION
DM-7220-S-24-WH	Double Face Starter	25 1/4"	19 1/2"	72"	8 1/2"	8	10			\$ 4,638	End, Mid, Top and Base Panels to be constructed from 1" thick 11-ply solid core, veneered 2 sides. Vertical, top and bottom edges banded with 1/4" external hardwood edging, edges to be eased. Front Edge: 3/4" thick x 2 1/2" high fascia - tongue and grooved to top.
DM-7220-A-24-WH	Double Face Adder	24 1/4"	19 1/2"	72"	8 1/2"	8	10			\$ 4,100	
DM-7224-S-24-WH	Double Face Starter	25 1/4"	23 1/2"	72"	10 1/2"	8	10			\$ 4,694	
DM-7224-A-24-WH	Double Face Adder	24 1/4"	23 1/2"	72"	10 1/2"	8	10			\$ 4,150	
DM-7220-S-30-WH	Double Face Starter	31 1/4"	19 1/2"	72"	8 1/2"	8	10			\$ 4,638	
DM-7220-A-30-WH	Double Face Adder	30 1/4"	19 1/2"	72"	8 1/2"	8	10			\$ 4,100	
DM-7224-S-30-WH	Double Face Starter	31 1/4"	23 1/2"	72"	10 1/2"	8	10			\$ 4,694	
DM-7224-A-30-WH	Double Face Adder	30 1/4"	23 1/2"	72"	10 1/2"	8	10			\$ 4,150	
DM-7220-S-36-WH	Double Face Starter	37 1/4"	19 1/2"	72"	8 1/2"	8	10	200 Lbs.	12 Cu Ft	\$ 4,419	
DM-7220-A-36-WH	Double Face Adder	36 1/4"	19 1/2"	72"	8 1/2"	8	10	164 Lbs.	11 Cu Ft	\$ 3,881	
DM-7224-S-36-WH	Double Face Starter	37 1/4"	23 1/2"	72"	10 1/2"	8	10	229 Lbs.	13 Cu Ft	\$ 4,469	
DM-7224-A-36-WH	Double Face Adder	36 1/4"	23 1/2"	72"	10 1/2"	8	10	186 Lbs.	12 Cu Ft	\$ 3,931	



Model Shown
DM-7224-S-36-WH



Model Shown
DM-7224-A-36-WH

DM-8220-S-24-WH	Double Face Starter	25 1/4"	19 1/2"	82"	8 1/2"	10	12			\$ 4,800	
DM-8220-A-24-WH	Double Face Adder	24 1/4"	19 1/2"	82"	8 1/2"	10	12			\$ 4,263	
DM-8224-S-24-WH	Double Face Starter	25 1/4"	23 1/2"	82"	10 1/2"	10	12			\$ 4,863	
DM-8224-A-24-WH	Double Face Adder	24 1/4"	23 1/2"	82"	10 1/2"	10	12			\$ 4,331	
DM-8220-S-30-WH	Double Face Starter	31 1/4"	19 1/2"	82"	8 1/2"	10	12			\$ 4,800	
DM-8220-A-30-WH	Double Face Adder	30 1/4"	19 1/2"	82"	8 1/2"	10	12			\$ 4,263	
DM-8224-S-30-WH	Double Face Starter	31 1/4"	23 1/2"	82"	10 1/2"	10	12			\$ 4,863	
DM-8224-A-30-WH	Double Face Adder	30 1/4"	23 1/2"	82"	10 1/2"	10	12			\$ 4,331	
DM-8220-S-36-WH	Double Face Starter	37 1/4"	19 1/2"	82"	8 1/2"	10	12	224 Lbs.	12 Cu Ft	\$ 4,581	
DM-8220-A-36-WH	Double Face Adder	36 1/4"	19 1/2"	82"	8 1/2"	10	12	184 Lbs.	11 Cu Ft	\$ 4,044	
DM-8224-S-36-WH	Double Face Starter	37 1/4"	23 1/2"	82"	10 1/2"	10	12	256 Lbs.	14 Cu Ft	\$ 4,644	
DM-8224-A-36-WH	Double Face Adder	36 1/4"	23 1/2"	82"	10 1/2"	10	12	207 Lbs.	12 Cu Ft	\$ 4,113	





Model Shown
DM-8224-S-36-WH



Model Shown
DM-8224-A-36-WH





SHELVING





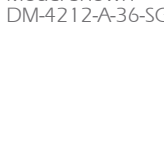

	MODEL NUMBER	PRODUCT	WIDTH	DEPTH	HEIGHT	SHELF DEPTH	# OF SHELVES	# OF OPENINGS	WEIGHT	VOLUME	LIST PRICE	DESCRIPTION
	DM-9620-S-24-WH	Double Face Starter	25 1/4"	19 1/2"	96"	8 1/2"	12	14			\$ 4,963	End, Mid, Top and Base Panels to be constructed from 1" thick 11-ply solid core, veneered 2 sides. Vertical, top and bottom edges banded with 1/4" external hardwood edging, edges to be eased. Front Edge: 3/4" thick x 2 1/2" high fascia - tongue and grooved to top.
	DM-9620-A-24-WH	Double Face Adder	24 1/4"	19 1/2"	96"	8 1/2"	12	14			\$ 4,431	
	DM-9624-S-24-WH	Double Face Starter	25 1/4"	23 1/2"	96"	10 1/2"	12	14			\$ 5,044	
	DM-9624-A-24-WH	Double Face Adder	24 1/4"	23 1/2"	96"	10 1/2"	12	14			\$ 4,519	
	DM-9620-S-30-WH	Double Face Starter	31 1/4"	19 1/2"	96"	8 1/2"	12	14			\$ 4,963	
	DM-9620-A-30-WH	Double Face Adder	30 1/4"	19 1/2"	96"	8 1/2"	12	14			\$ 4,431	
	DM-9624-S-30-WH	Double Face Starter	31 1/4"	23 1/2"	96"	10 1/2"	12	14			\$ 5,044	
	DM-9624-A-30-WH	Double Face Adder	30 1/4"	23 1/2"	96"	10 1/2"	12	14			\$ 4,519	
	DM-9620-S-36-WH	Double Face Starter	37 1/4"	19 1/2"	96"	8 1/2"	12	14	276 Lbs.	13 Cu Ft	\$ 4,750	
	DM-9620-A-36-WH	Double Face Adder	36 1/4"	19 1/2"	96"	8 1/2"	12	14	220 Lbs.	12 Cu Ft	\$ 4,213	
	DM-9624-S-36-WH	Double Face Starter	37 1/4"	23 1/2"	96"	10 1/2"	12	14	315 Lbs.	15 Cu Ft	\$ 4,819	
	DM-9624-A-36-WH	Double Face Adder	36 1/4"	23 1/2"	96"	10 1/2"	12	14	247 Lbs.	13 Cu Ft	\$ 4,288	

Model Shown
DM-9624-S-36-WH

Model Shown
DM-9624-A-36-WH

SHELVING

	MODEL NUMBER	PRODUCT	WIDTH	DEPTH	HEIGHT	SHELF DEPTH	# OF SHELVES	# OF OPENINGS	WEIGHT	VOLUME	LIST PRICE	DESCRIPTION
	DM-3610-S-24-SG	Single Face Starter	25 1/4"	10 1/8"	36"	8 1/2"	1	2			\$ 1,900	End, Mid, Top and Base Panels to be constructed from 1" thick 11-ply solid core, veneered 2 sides. Vertical, top and bottom edges banded with 1/4" external hardwood edging, edges to be eased. Front Edge: 3/4" thick x 2 1/2" high fascia - tongue and grooved to top.
	DM-3610-A-24-SG	Single Face Adder	24 1/4"	10 1/8"	36"	8 1/2"	1	2			\$ 1,619	
	DM-3612-S-24-SG	Single Face Starter	25 1/4"	12 1/8"	36"	10 1/2"	1	2			\$ 1,944	
	DM-3612-A-24-SG	Single Face Adder	24 1/4"	12 1/8"	36"	10 1/2"	1	2			\$ 1,644	
	DM-3610-S-30-SG	Single Face Starter	31 1/4"	10 1/8"	36"	8 1/2"	1	2			\$ 1,900	
	DM-3610-A-30-SG	Single Face Adder	30 1/4"	10 1/8"	36"	8 1/2"	1	2			\$ 1,619	
	DM-3612-S-30-SG	Single Face Starter	31 1/4"	12 1/8"	36"	10 1/2"	1	2			\$ 1,944	
	DM-3612-A-30-SG	Single Face Adder	30 1/4"	12 1/8"	36"	10 1/2"	1	2			\$ 1,644	
	DM-3610-S-36-SG	Single Face Starter	37 1/4"	10 1/8"	36"	8 1/2"	1	2	50.6 Lbs.	4 Cu Ft	\$ 1,769	
	DM-3610-A-36-SG	Single Face Adder	36 1/4"	10 1/8"	36"	8 1/2"	1	2	46 Lbs.	4 Cu Ft	\$ 1,494	
	DM-3612-S-36-SG	Single Face Starter	37 1/4"	12 1/8"	36"	10 1/2"	1	2	50.6 Lbs.	5 Cu Ft	\$ 1,806	
	DM-3612-A-36-SG	Single Face Adder	36 1/4"	12 1/8"	36"	10 1/2"	1	2	47.2 Lbs.	5 Cu Ft	\$ 1,506	
	DM-4210-S-24-SG	Single Face Starter	25 1/4"	10 1/8"	42"	8 1/2"	2	3			\$ 1,981	
	DM-4210-A-24-SG	Single Face Adder	24 1/4"	10 1/8"	42"	8 1/2"	2	3			\$ 1,700	
	DM-4212-S-24-SG	Single Face Starter	25 1/4"	12 1/8"	42"	10 1/2"	2	3			\$ 2,025	
	DM-4212-A-24-SG	Single Face Adder	24 1/4"	12 1/8"	42"	10 1/2"	2	3			\$ 1,725	
	DM-4210-S-30-SG	Single Face Starter	31 1/4"	10 1/8"	42"	8 1/2"	2	3			\$ 1,981	
	DM-4210-A-30-SG	Single Face Adder	30 1/4"	10 1/8"	42"	8 1/2"	2	3			\$ 1,700	
	DM-4212-S-30-SG	Single Face Starter	31 1/4"	12 1/8"	42"	10 1/2"	2	3			\$ 2,025	
	DM-4212-A-30-SG	Single Face Adder	30 1/4"	12 1/8"	42"	10 1/2"	2	3			\$ 1,725	
	DM-4210-S-36-SG	Single Face Starter	37 1/4"	10 1/8"	42"	8 1/2"	2	3	55 Lbs.	5 Cu Ft	\$ 1,844	
	DM-4210-A-36-SG	Single Face Adder	36 1/4"	10 1/8"	42"	8 1/2"	2	3	52 Lbs.	5 Cu Ft	\$ 1,563	
	DM-4212-S-36-SG	Single Face Starter	37 1/4"	12 1/8"	42"	10 1/2"	2	3	60 Lbs.	5 Cu Ft	\$ 1,881	
	DM-4212-A-36-SG	Single Face Adder	36 1/4"	12 1/8"	42"	10 1/2"	2	3	53 Lbs.	5 Cu Ft	\$ 1,588	

	MODEL NUMBER	PRODUCT	WIDTH	DEPTH	HEIGHT	SHELF DEPTH	# OF SHELVES	# OF OPENINGS	WEIGHT	VOLUME	LIST PRICE	DESCRIPTION
 <p>Model Shown DM-4212-S-36-SG</p>	DM-4810-S-24-SG	Single Face Starter	25 1/4"	10 1/8"	48"	8 1/2"	2	3			\$ 2,038	End, Mid, Top and Base Panels to be constructed from 1" thick 11-ply solid core, veneered 2 sides. Vertical, top and bottom edges banded with 1/4" external hardwood edging, edges to be eased. Front Edge: 3/4" thick x 2 1/2" high fascia - tongue and grooved to top.
	DM-4810-A-24-SG	Single Face Adder	24 1/4"	10 1/8"	48"	8 1/2"	2	3			\$ 1,744	
	DM-4812-S-24-SG	Single Face Starter	25 1/4"	12 1/8"	48"	10 1/2"	2	3			\$ 2,050	
	DM-4812-A-24-SG	Single Face Adder	24 1/4"	12 1/8"	48"	10 1/2"	2	3			\$ 1,744	
 <p>Model Shown DM-4212-A-36-SG</p>	DM-4810-S-30-SG	Single Face Starter	31 1/4"	10 1/8"	48"	8 1/2"	2	3			\$ 2,063	
	DM-4810-A-30-SG	Single Face Adder	30 1/4"	10 1/8"	48"	8 1/2"	2	3			\$ 1,744	
	DM-4812-S-30-SG	Single Face Starter	31 1/4"	12 1/8"	48"	10 1/2"	2	3			\$ 2,050	
	DM-4812-A-30-SG	Single Face Adder	30 1/4"	12 1/8"	48"	10 1/2"	2	3			\$ 1,744	
 <p>Model Shown DM-4212-A-36-SG</p>	DM-4810-S-36-SG	Single Face Starter	37 1/4"	10 1/8"	48"	8 1/2"	2	3	74.8 Lbs.	5 Cu Ft	\$ 1,900	
	DM-4810-A-36-SG	Single Face Adder	36 1/4"	10 1/8"	48"	8 1/2"	2	3	65.5 Lbs.	5 Cu Ft	\$ 1,606	
	DM-4812-S-36-SG	Single Face Starter	37 1/4"	12 1/8"	48"	10 1/2"	2	3	82.8 Lbs.	6 Cu Ft	\$ 1,913	
	DM-4812-A-36-SG	Single Face Adder	36 1/4"	12 1/8"	48"	10 1/2"	2	3	71.3 Lbs.	6 Cu Ft	\$ 1,606	
 <p>Model Shown DM-6012-S-36-SG</p>	DM-6010-S-24-SG	Single Face Starter	25 1/4"	10 1/8"	60"	8 1/2"	3	4			\$ 2,594	
	DM-6010-A-24-SG	Single Face Adder	24 1/4"	10 1/8"	60"	8 1/2"	3	4			\$ 2,313	
	DM-6012-S-24-SG	Single Face Starter	25 1/4"	12 1/8"	60"	10 1/2"	3	4			\$ 2,631	
	DM-6012-A-24-SG	Single Face Adder	24 1/4"	12 1/8"	60"	10 1/2"	3	4			\$ 2,338	
 <p>Model Shown DM-6012-A-36-SG</p>	DM-6010-S-30-SG	Single Face Starter	31 1/4"	10 1/8"	60"	8 1/2"	3	4			\$ 2,594	
	DM-6010-A-30-SG	Single Face Adder	30 1/4"	10 1/8"	60"	8 1/2"	3	4			\$ 2,313	
	DM-6012-S-30-SG	Single Face Starter	31 1/4"	12 1/8"	60"	10 1/2"	3	4			\$ 2,631	
	DM-6012-A-30-SG	Single Face Adder	30 1/4"	12 1/8"	60"	10 1/2"	3	4			\$ 2,338	
 <p>Model Shown DM-6012-A-36-SG</p>	DM-6010-S-36-SG	Single Face Starter	37 1/4"	10 1/8"	60"	8 1/2"	3	4	100 Lbs.	6 Cu Ft	\$ 2,431	
	DM-6010-A-36-SG	Single Face Adder	36 1/4"	10 1/8"	60"	8 1/2"	3	4	86.3 Lbs.	6 Cu Ft	\$ 2,175	
	DM-6012-S-36-SG	Single Face Starter	37 1/4"	12 1/8"	60"	10 1/2"	3	4	116 Lbs.	8 Cu Ft	\$ 2,494	
	DM-6012-A-36-SG	Single Face Adder	36 1/4"	12 1/8"	60"	10 1/2"	3	4	95.5 Lbs.	7 Cu Ft	\$ 2,200	

SHELVING

MODEL NUMBER	PRODUCT	WIDTH	DEPTH	HEIGHT	SHELF DEPTH	# OF SHELVES	# OF OPENINGS	WEIGHT	VOLUME	LIST PRICE	DESCRIPTION
DM-7210-S-24-SG	Single Face Starter	25 1/4"	10 1/8"	72"	8 1/2"	4	5			\$ 2,675	End, Mid, Top and Base Panels to be constructed from 1" thick 11-ply solid core, veneered 2 sides. Vertical, top and bottom edges banded with 1/4" external hardwood edging, edges to be eased. Front Edge: 3/4" thick x 2 1/2" high fascia - tongue and grooved to top.
DM-7210-A-24-SG	Single Face Adder	24 1/4"	10 1/8"	72"	8 1/2"	4	5			\$ 2,381	
DM-7212-S-24-SG	Single Face Starter	25 1/4"	12 1/8"	72"	10 1/2"	4	5			\$ 2,719	
DM-7212-A-24-SG	Single Face Adder	24 1/4"	12 1/8"	72"	10 1/2"	4	5			\$ 2,431	
DM-7210-S-30-SG	Single Face Starter	31 1/4"	10 1/8"	72"	8 1/2"	4	5			\$ 2,675	
DM-7210-A-30-SG	Single Face Adder	30 1/4"	10 1/8"	72"	8 1/2"	4	5			\$ 2,381	
DM-7212-S-30-SG	Single Face Starter	31 1/4"	12 1/8"	72"	10 1/2"	4	5			\$ 2,719	
DM-7212-A-30-SG	Single Face Adder	30 1/4"	12 1/8"	72"	10 1/2"	4	5			\$ 2,431	
DM-7210-S-36-SG	Single Face Starter	37 1/4"	10 1/8"	72"	8 1/2"	4	5	115 Lbs.	7 Cu Ft	\$ 2,531	
DM-7210-A-36-SG	Single Face Adder	36 1/4"	10 1/8"	72"	8 1/2"	4	5	96.6 Lbs.	7 Cu Ft	\$ 2,244	
DM-7212-S-36-SG	Single Face Starter	37 1/4"	12 1/8"	72"	10 1/2"	4	5	131 Lbs.	8 Cu Ft	\$ 2,581	
DM-7212-A-36-SG	Single Face Adder	36 1/4"	12 1/8"	72"	10 1/2"	4	5	109 Lbs.	8 Cu Ft	\$ 2,288	



Model Shown
DM-7212-S-36-SG



Model Shown
DM-7212-A-36-SG



Model Shown
DM-8212-S-36-SG



Model Shown
DM-8212-A-36-SG

DM-8210-S-24-SG	Single Face Starter	25 1/4"	10 1/8"	82"	8 1/2"	5	6			\$ 2,756
DM-8210-A-24-SG	Single Face Adder	24 1/4"	10 1/8"	82"	8 1/2"	5	6			\$ 2,469
DM-8212-S-24-SG	Single Face Starter	25 1/4"	12 1/8"	82"	10 1/2"	5	6			\$ 2,806
DM-8212-A-24-SG	Single Face Adder	24 1/4"	12 1/8"	82"	10 1/2"	5	6			\$ 2,506
DM-8210-S-30-SG	Single Face Starter	31 1/4"	10 1/8"	82"	8 1/2"	5	6			\$ 2,756
DM-8210-A-30-SG	Single Face Adder	30 1/4"	10 1/8"	82"	8 1/2"	5	6			\$ 2,469
DM-8212-S-30-SG	Single Face Starter	31 1/4"	12 1/8"	82"	10 1/2"	5	6			\$ 2,806
DM-8212-A-30-SG	Single Face Adder	30 1/4"	12 1/8"	82"	10 1/2"	5	6			\$ 2,506
DM-8210-S-36-SG	Single Face Starter	37 1/4"	10 1/8"	82"	8 1/2"	5	6	129 Lbs.	8 Cu Ft	\$ 2,619
DM-8210-A-36-SG	Single Face Adder	36 1/4"	10 1/8"	82"	8 1/2"	5	6	107 Lbs.	7 Cu Ft	\$ 2,331
DM-8212-S-36-SG	Single Face Starter	37 1/4"	12 1/8"	82"	10 1/2"	5	6	145 Lbs.	9 Cu Ft	\$ 2,669
DM-8212-A-36-SG	Single Face Adder	36 1/4"	12 1/8"	82"	10 1/2"	5	6	122 Lbs.	8 Cu Ft	\$ 2,369

SHELVING

MODEL NUMBER	PRODUCT	WIDTH	DEPTH	HEIGHT	SHELF DEPTH	# OF SHELVES	# OF OPENINGS	WEIGHT	VOLUME	LIST PRICE	DESCRIPTION
DM-9610-S-24-SG	Single Face Starter	25 1/4"	10 1/8"	96"	8 1/2"	6	7			\$ 2,825	End, Mid, Top and Base Panels to be constructed from 1" thick 11-ply solid core, veneered 2 sides. Vertical, top and bottom edges banded with 1/4" external hardwood edging, edges to be eased. Front Edge: 3/4" thick x 2 1/2" high fascia - tongue and grooved to top.
DM-9610-A-24-SG	Single Face Adder	24 1/4"	10 1/8"	96"	8 1/2"	6	7			\$ 2,544	
DM-9612-S-24-SG	Single Face Starter	25 1/4"	12 1/8"	96"	10 1/2"	6	7			\$ 2,894	
DM-9612-A-24-SG	Single Face Adder	24 1/4"	12 1/8"	96"	10 1/2"	6	7			\$ 2,594	
DM-9610-S-30-SG	Single Face Starter	31 1/4"	10 1/8"	96"	8 1/2"	6	7			\$ 2,825	
DM-9610-A-30-SG	Single Face Adder	30 1/4"	10 1/8"	96"	8 1/2"	6	7			\$ 2,544	
DM-9612-S-30-SG	Single Face Starter	31 1/4"	12 1/8"	96"	10 1/2"	6	7			\$ 2,894	
DM-9612-A-30-SG	Single Face Adder	30 1/4"	12 1/8"	96"	10 1/2"	6	7			\$ 2,594	
DM-9610-S-36-SG	Single Face Starter	37 1/4"	10 1/8"	96"	8 1/2"	6	7	156 Lbs.	9 Cu Ft	\$ 2,688	
DM-9610-A-36-SG	Single Face Adder	36 1/4"	10 1/8"	96"	8 1/2"	6	7	128 Lbs.	8 Cu Ft	\$ 2,406	
DM-9612-S-36-SG	Single Face Starter	37 1/4"	12 1/8"	96"	10 1/2"	6	7	177 Lbs.	10 Cu Ft	\$ 2,756	
DM-9612-A-36-SG	Single Face Adder	36 1/4"	12 1/8"	96"	10 1/2"	6	7	145 Lbs.	9 Cu Ft	\$ 2,456	













Model Shown
DM-9612-S-36-SG

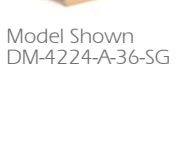





Model Shown
DM-9612-A-36-SG

SHELVING

	MODEL NUMBER	PRODUCT	WIDTH	DEPTH	HEIGHT	SHELF DEPTH	# OF SHELVES	# OF OPENINGS	WEIGHT	VOLUME	LIST PRICE	DESCRIPTION
 Model Shown DM-3620-S-24-SG	DM-3620-S-24-SG	Double Face Starter	25 1/4"	19 1/2"	36"	8 1/2"	2	4			\$ 3,738	End, Mid, Top and Base Panels to be constructed from 1" thick 11-ply solid core, veneered 2 sides. Vertical, top and bottom edges banded with 1/4" external hardwood edging, edges to be eased. Front Edge: 3/4" thick x 2 1/2" high fascia - tongue and grooved to top.
	DM-3620-A-24-SG	Double Face Adder	24 1/4"	19 1/2"	36"	8 1/2"	2	4			\$ 3,250	
	DM-3624-S-24-SG	Double Face Starter	25 1/4"	23 1/2"	36"	10 1/2"	2	4			\$ 3,775	
	DM-3624-A-24-SG	Double Face Adder	24 1/4"	23 1/2"	36"	10 1/2"	2	4			\$ 3,263	
 Model Shown DM-3620-S-30-SG	DM-3620-S-30-SG	Double Face Starter	31 1/4"	19 1/2"	36"	8 1/2"	2	4			\$ 3,738	
	DM-3620-A-30-SG	Double Face Adder	30 1/4"	19 1/2"	36"	8 1/2"	2	4			\$ 3,250	
	DM-3624-S-30-SG	Double Face Starter	31 1/4"	23 1/2"	36"	10 1/2"	2	4			\$ 3,775	
	DM-3624-A-30-SG	Double Face Adder	30 1/4"	23 1/2"	36"	10 1/2"	2	4			\$ 3,263	
 Model Shown DM-3620-S-36-SG	DM-3620-S-36-SG	Double Face Starter	37 1/4"	19 1/2"	36"	8 1/2"	2	4	88.6 Lbs.	7 Cu Ft	\$ 3,525	
	DM-3620-A-36-SG	Double Face Adder	36 1/4"	19 1/2"	36"	8 1/2"	2	4	73.6 Lbs.	6 Cu Ft	\$ 3,038	
	DM-3624-S-36-SG	Double Face Starter	37 1/4"	23 1/2"	36"	10 1/2"	2	4	110 Lbs.	10 Cu Ft	\$ 3,569	
	DM-3624-A-36-SG	Double Face Adder	36 1/4"	23 1/2"	36"	10 1/2"	2	4	88.6 Lbs.	9 Cu Ft	\$ 3,056	
 Model Shown DM-4220-S-24-SG	DM-4220-S-24-SG	Double Face Starter	25 1/4"	19 1/2"	42"	8 1/2"	4	6			\$ 3,900	
	DM-4220-A-24-SG	Double Face Adder	24 1/4"	19 1/2"	42"	8 1/2"	4	6			\$ 3,413	
	DM-4224-S-24-SG	Double Face Starter	25 1/4"	23 1/2"	42"	10 1/2"	4	6			\$ 3,944	
	DM-4224-A-24-SG	Double Face Adder	24 1/4"	23 1/2"	42"	10 1/2"	4	6			\$ 3,438	
 Model Shown DM-4220-S-30-SG	DM-4220-S-30-SG	Double Face Starter	31 1/4"	19 1/2"	42"	8 1/2"	4	6			\$ 3,900	
	DM-4220-A-30-SG	Double Face Adder	30 1/4"	19 1/2"	42"	8 1/2"	4	6			\$ 3,413	
	DM-4224-S-30-SG	Double Face Starter	31 1/4"	23 1/2"	42"	10 1/2"	4	6			\$ 3,944	
	DM-4224-A-30-SG	Double Face Adder	30 1/4"	23 1/2"	42"	10 1/2"	4	6			\$ 3,438	
 Model Shown DM-4220-S-36-SG	DM-4220-S-36-SG	Double Face Starter	37 1/4"	19 1/2"	42"	8 1/2"	4	6	94 Lbs.	7 Cu Ft	\$ 3,694	
	DM-4220-A-36-SG	Double Face Adder	36 1/4"	19 1/2"	42"	8 1/2"	4	6	78 Lbs.	7 Cu Ft	\$ 3,200	
	DM-4224-S-36-SG	Double Face Starter	37 1/4"	23 1/2"	42"	10 1/2"	4	6	115 Lbs.	10 Cu Ft	\$ 3,738	
	DM-4224-A-36-SG	Double Face Adder	36 1/4"	23 1/2"	42"	10 1/2"	4	6	113 Lbs.	10 Cu Ft	\$ 3,219	

	MODEL NUMBER	PRODUCT	WIDTH	DEPTH	HEIGHT	SHELF DEPTH	# OF SHELVES	# OF OPENINGS	WEIGHT	VOLUME	LIST PRICE	DESCRIPTION
 <p>Model Shown DM-4224-S-36-SG</p>	DM-4820-S-24-SG	Double Face Starter	25 1/4"	19 1/2"	48"	8 1/2"	4	6			\$ 4,094	End, Mid, Top and Base Panels to be constructed from 1" thick 11-ply solid core, veneered 2 sides. Vertical, top and bottom edges banded with 1/4" external hardwood edging, edges to be eased. Front Edge: 3/4" thick x 2 1/2" high fascia - tongue and grooved to top.
	DM-4820-A-24-SG	Double Face Adder	24 1/4"	19 1/2"	48"	8 1/2"	4	6			\$ 3,581	
	DM-4824-S-24-SG	Double Face Starter	25 1/4"	23 1/2"	48"	10 1/2"	4	6			\$ 4,138	
	DM-4824-A-24-SG	Double Face Adder	24 1/4"	23 1/2"	48"	10 1/2"	4	6			\$ 3,606	
 <p>Model Shown DM-4224-A-36-SG</p>	DM-4820-S-30-SG	Double Face Starter	31 1/4"	19 1/2"	48"	8 1/2"	4	6			\$ 4,094	
	DM-4820-A-30-SG	Double Face Adder	30 1/4"	19 1/2"	48"	8 1/2"	4	6			\$ 3,581	
	DM-4824-S-30-SG	Double Face Starter	31 1/4"	23 1/2"	48"	10 1/2"	4	6			\$ 4,138	
	DM-4824-A-30-SG	Double Face Adder	30 1/4"	23 1/2"	48"	10 1/2"	4	6			\$ 3,606	
 <p>Model Shown DM-4224-S-36-SG</p>	DM-4820-S-36-SG	Double Face Starter	37 1/4"	19 1/2"	48"	8 1/2"	4	6	132 Lbs.	9 Cu Ft	\$ 3,869	
	DM-4820-A-36-SG	Double Face Adder	36 1/4"	19 1/2"	48"	8 1/2"	4	6	109 Lbs.	8 Cu Ft	\$ 3,356	
	DM-4824-S-36-SG	Double Face Starter	37 1/4"	23 1/2"	48"	10 1/2"	4	6	155 Lbs.	11 Cu Ft	\$ 3,925	
	DM-4824-A-36-SG	Double Face Adder	36 1/4"	23 1/2"	48"	10 1/2"	4	6	127 Lbs.	10 Cu Ft	\$ 3,381	
 <p>Model Shown DM-6024-S-36-SG</p>	DM-6020-S-24-SG	Double Face Starter	25 1/4"	19 1/2"	60"	8 1/2"	6	8			\$ 5,200	
	DM-6020-A-24-SG	Double Face Adder	24 1/4"	19 1/2"	60"	8 1/2"	6	8			\$ 4,694	
	DM-6024-S-24-SG	Double Face Starter	25 1/4"	23 1/2"	60"	10 1/2"	6	8			\$ 5,238	
	DM-6024-A-24-SG	Double Face Adder	24 1/4"	23 1/2"	60"	10 1/2"	6	8			\$ 4,738	
 <p>Model Shown DM-6024-A-36-SG</p>	DM-6020-S-30-SG	Double Face Starter	31 1/4"	19 1/2"	60"	8 1/2"	6	8			\$ 5,200	
	DM-6020-A-30-SG	Double Face Adder	30 1/4"	19 1/2"	60"	8 1/2"	6	8			\$ 4,694	
	DM-6024-S-30-SG	Double Face Starter	31 1/4"	23 1/2"	60"	10 1/2"	6	8			\$ 5,238	
	DM-6024-A-30-SG	Double Face Adder	30 1/4"	23 1/2"	60"	10 1/2"	6	8			\$ 4,738	
 <p>Model Shown DM-6024-S-36-SG</p>	DM-6020-S-36-SG	Double Face Starter	37 1/4"	19 1/2"	60"	8 1/2"	6	8	176 Lbs.	11 Cu Ft	\$ 4,994	
	DM-6020-A-36-SG	Double Face Adder	36 1/4"	19 1/2"	60"	8 1/2"	6	8	145 Lbs.	10 Cu Ft	\$ 4,481	
	DM-6024-S-36-SG	Double Face Starter	37 1/4"	23 1/2"	60"	10 1/2"	6	8	200 Lbs.	12 Cu Ft	\$ 5,038	
	DM-6024-A-36-SG	Double Face Adder	36 1/4"	23 1/2"	60"	10 1/2"	6	8	164 Lbs.	11 Cu Ft	\$ 4,531	

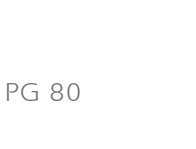
	MODEL NUMBER	PRODUCT	WIDTH	DEPTH	HEIGHT	SHELF DEPTH	# OF SHELVES	# OF OPENINGS	WEIGHT	VOLUME	LIST PRICE	DESCRIPTION
	DM-7220-S-24-SG	Double Face Starter	25 1/4"	19 1/2"	72"	8 1/2"	8	10			\$ 5,369	End, Mid, Top and Base Panels to be constructed from 1" thick 11-ply solid core, veneered 2 sides. Vertical, top and bottom edges banded with 1/4" external hardwood edging, edges to be eased. Front Edge: 3/4" thick x 2 1/2" high fascia - tongue and grooved to top.
	DM-7220-A-24-SG	Double Face Adder	24 1/4"	19 1/2"	72"	8 1/2"	8	10			\$ 4,856	
	DM-7224-S-24-SG	Double Face Starter	25 1/4"	23 1/2"	72"	10 1/2"	8	10			\$ 5,294	
	DM-7224-A-24-SG	Double Face Adder	24 1/4"	23 1/2"	72"	10 1/2"	8	10			\$ 4,900	
	DM-7220-S-30-SG	Double Face Starter	31 1/4"	19 1/2"	72"	8 1/2"	8	10			\$ 5,369	
	DM-7220-A-30-SG	Double Face Adder	30 1/4"	19 1/2"	72"	8 1/2"	8	10			\$ 4,856	
	DM-7224-S-30-SG	Double Face Starter	31 1/4"	23 1/2"	72"	10 1/2"	8	10			\$ 5,294	
	DM-7224-A-30-SG	Double Face Adder	30 1/4"	23 1/2"	72"	10 1/2"	8	10			\$ 4,900	
	DM-7220-S-36-SG	Double Face Starter	37 1/4"	19 1/2"	72"	8 1/2"	8	10	200 Lbs.	12 Cu Ft	\$ 5,156	
	DM-7220-A-36-SG	Double Face Adder	36 1/4"	19 1/2"	72"	8 1/2"	8	10	164 Lbs.	11 Cu Ft	\$ 4,644	
	DM-7224-S-36-SG	Double Face Starter	37 1/4"	23 1/2"	72"	10 1/2"	8	10	229 Lbs.	13 Cu Ft	\$ 5,206	
	DM-7224-A-36-SG	Double Face Adder	36 1/4"	23 1/2"	72"	10 1/2"	8	10	186 Lbs.	12 Cu Ft	\$ 4,694	
	DM-8220-S-24-SG	Double Face Starter	25 1/4"	19 1/2"	82"	8 1/2"	10	12			\$ 5,519	
	DM-8220-A-24-SG	Double Face Adder	24 1/4"	19 1/2"	82"	8 1/2"	10	12			\$ 5,013	
	DM-8224-S-24-SG	Double Face Starter	25 1/4"	23 1/2"	82"	10 1/2"	10	12			\$ 5,575	
	DM-8224-A-24-SG	Double Face Adder	24 1/4"	23 1/2"	82"	10 1/2"	10	12			\$ 5,075	
	DM-8220-S-30-SG	Double Face Starter	31 1/4"	19 1/2"	82"	8 1/2"	10	12			\$ 5,519	
	DM-8220-A-30-SG	Double Face Adder	30 1/4"	19 1/2"	82"	8 1/2"	10	12			\$ 5,013	
	DM-8224-S-30-SG	Double Face Starter	31 1/4"	23 1/2"	82"	10 1/2"	10	12			\$ 5,575	
	DM-8224-A-30-SG	Double Face Adder	30 1/4"	23 1/2"	82"	10 1/2"	10	12			\$ 5,075	
	DM-8220-S-36-SG	Double Face Starter	37 1/4"	19 1/2"	82"	8 1/2"	10	12	224 Lbs.	12 Cu Ft	\$ 5,306	
	DM-8220-A-36-SG	Double Face Adder	36 1/4"	19 1/2"	82"	8 1/2"	10	12	184 Lbs.	11 Cu Ft	\$ 4,800	
	DM-8224-S-36-SG	Double Face Starter	37 1/4"	23 1/2"	82"	10 1/2"	10	12	256 Lbs.	14 Cu Ft	\$ 5,356	
	DM-8224-A-36-SG	Double Face Adder	36 1/4"	23 1/2"	82"	10 1/2"	10	12	207 Lbs.	12 Cu Ft	\$ 4,869	

Model Shown
DM-7224-S-36-SG

Model Shown
DM-7224-A-36-SG

Model Shown
DM-8224-S-36-SG

Model Shown
DM-8224-A-36-SG

SHELVING

MODEL NUMBER	PRODUCT	WIDTH	DEPTH	HEIGHT	SHELF DEPTH	# OF SHELVES	# OF OPENINGS	WEIGHT	VOLUME	LIST PRICE	DESCRIPTION
DM-9620-S-24-SG	Double Face Starter	25 1/4"	19 1/2"	96"	8 1/2"	12	14			\$ 5,675	End, Mid, Top and Base Panels to be constructed from 1" thick 11-ply solid core, veneered 2 sides. Vertical, top and bottom edges banded with 1/4" external hardwood edging, edges to be eased. Front Edge: 3/4" thick x 2 1/2" high fascia - tongue and grooved to top.
DM-9620-A-24-SG	Double Face Adder	24 1/4"	19 1/2"	96"	8 1/2"	12	14			\$ 5,169	
DM-9624-S-24-SG	Double Face Starter	25 1/4"	23 1/2"	96"	10 1/2"	12	14			\$ 5,756	
DM-9624-A-24-SG	Double Face Adder	24 1/4"	23 1/2"	96"	10 1/2"	12	14			\$ 5,238	
DM-9620-S-30-SG	Double Face Starter	31 1/4"	19 1/2"	96"	8 1/2"	12	14			\$ 5,675	
DM-9620-A-30-SG	Double Face Adder	30 1/4"	19 1/2"	96"	8 1/2"	12	14			\$ 5,169	
DM-9624-S-30-SG	Double Face Starter	31 1/4"	23 1/2"	96"	10 1/2"	12	14			\$ 5,756	
DM-9624-A-30-SG	Double Face Adder	30 1/4"	23 1/2"	96"	10 1/2"	12	14			\$ 5,238	
DM-9620-S-36-SG	Double Face Starter	37 1/4"	19 1/2"	96"	8 1/2"	12	14	276 Lbs.	13 Cu Ft	\$ 5,469	
DM-9620-A-36-SG	Double Face Adder	36 1/4"	19 1/2"	96"	8 1/2"	12	14	220 Lbs.	12 Cu Ft	\$ 4,956	
DM-9624-S-36-SG	Double Face Starter	37 1/4"	23 1/2"	96"	10 1/2"	12	14	315 Lbs.	15 Cu Ft	\$ 5,538	
DM-9624-A-36-SG	Double Face Adder	36 1/4"	23 1/2"	96"	10 1/2"	12	14	247 Lbs.	13 Cu Ft	\$ 5,031	







Model Shown
DM-9624-S-36-SG



Model Shown
DM-9624-A-36-SG

SHELVING

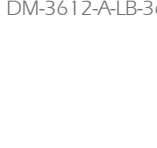
	MODEL NUMBER	PRODUCT	WIDTH	DEPTH	HEIGHT	SHELF DEPTH	# OF SHELVES	# OF OPENINGS	WEIGHT	VOLUME	LIST PRICE	DESCRIPTION
 Model Shown DM-3610-S-LB-24	DM-3610-S-LB-24	Single Face Starter	25 1/4"	10 1/8"	36"	9 1/2"	1	2			\$ 1,038	End, Mid, Top and Base Panels to be constructed from 1" thick 11-ply solid core, veneered 2 sides. Vertical, top and bottom edges banded with 1/4" external hardwood edging, edges to be eased. Front Edge: 3/4" thick x 2 1/2" high fascia - tongue and grooved to top.
	DM-3610-A-LB-24	Single Face Adder	24 1/4"	10 1/8"	36"	9 1/2"	1	2			\$ 738	
	DM-3612-S-LB-24	Single Face Starter	25 1/4"	12 1/8"	36"	11 1/2"	1	2			\$ 1,088	
	DM-3612-A-LB-24	Single Face Adder	24 1/4"	12 1/8"	36"	11 1/2"	1	2			\$ 763	
 Model Shown DM-3610-S-LB-30	DM-3610-S-LB-30	Single Face Starter	31 1/4"	10 1/8"	36"	9 1/2"	1	2			\$ 1,038	
	DM-3610-A-LB-30	Single Face Adder	30 1/4"	10 1/8"	36"	9 1/2"	1	2			\$ 738	
	DM-3612-S-LB-30	Single Face Starter	31 1/4"	12 1/8"	36"	11 1/2"	1	2			\$ 1,088	
	DM-3612-A-LB-30	Single Face Adder	30 1/4"	12 1/8"	36"	11 1/2"	1	2			\$ 763	
 Model Shown DM-3610-S-LB-36	DM-3610-S-LB-36	Single Face Starter	37 1/4"	10 1/8"	36"	9 1/2"	1	2	50.6 Lbs.	4 Cu Ft	\$ 888	
	DM-3610-A-LB-36	Single Face Adder	36 1/4"	10 1/8"	36"	9 1/2"	1	2	46 Lbs.	4 Cu Ft	\$ 581	
	DM-3612-S-LB-36	Single Face Starter	37 1/4"	12 1/8"	36"	11 1/2"	1	2	50.6 Lbs.	5 Cu Ft	\$ 931	
	DM-3612-A-LB-36	Single Face Adder	36 1/4"	12 1/8"	36"	11 1/2"	1	2	47.2 Lbs.	5 Cu Ft	\$ 613	
 Model Shown DM-4210-S-LB-24	DM-4210-S-LB-24	Single Face Starter	25 1/4"	10 1/8"	42"	9 1/2"	2	3			\$ 1,119	
	DM-4210-A-LB-24	Single Face Adder	24 1/4"	10 1/8"	42"	9 1/2"	2	3			\$ 819	
	DM-4212-S-LB-24	Single Face Starter	25 1/4"	12 1/8"	42"	11 1/2"	2	3			\$ 1,163	
	DM-4212-A-LB-24	Single Face Adder	24 1/4"	12 1/8"	42"	11 1/2"	2	3			\$ 850	
 Model Shown DM-4210-S-LB-30	DM-4210-S-LB-30	Single Face Starter	31 1/4"	10 1/8"	42"	9 1/2"	2	3			\$ 1,119	
	DM-4210-A-LB-30	Single Face Adder	30 1/4"	10 1/8"	42"	9 1/2"	2	3			\$ 819	
	DM-4212-S-LB-30	Single Face Starter	31 1/4"	12 1/8"	42"	11 1/2"	2	3			\$ 1,163	
	DM-4212-A-LB-30	Single Face Adder	30 1/4"	12 1/8"	42"	11 1/2"	2	3			\$ 850	
 Model Shown DM-4210-S-LB-36	DM-4210-S-LB-36	Single Face Starter	37 1/4"	10 1/8"	42"	9 1/2"	2	3	55 Lbs.	5 Cu Ft	\$ 969	
	DM-4210-A-LB-36	Single Face Adder	36 1/4"	10 1/8"	42"	9 1/2"	2	3	52 Lbs.	5 Cu Ft	\$ 631	
	DM-4212-S-LB-36	Single Face Starter	37 1/4"	12 1/8"	42"	11 1/2"	2	3	60 Lbs.	5 Cu Ft	\$ 1,013	
	DM-4212-A-LB-36	Single Face Adder	36 1/4"	12 1/8"	42"	11 1/2"	2	3	53 Lbs.	5 Cu Ft	\$ 694	

MODEL NUMBER	PRODUCT	WIDTH	DEPTH	HEIGHT	SHELF DEPTH	# OF SHELVES	# OF OPENINGS	WEIGHT	VOLUME	LIST PRICE	DESCRIPTION
											End, Mid, Top and Base Panels to be constructed from 1" thick 11-ply solid core, veneered 2 sides. Vertical, top and bottom edges banded with 1/4" external hardwood edging, edges to be eased. Front Edge: 3/4" thick x 2 1/2" high fascia - tongue and grooved to top.
DM-4810-S-LB-24	Single Face Starter	25 1/4"	10 1/8"	48"	9 1/2"	2	3			\$ 1,144	
DM-4810-A-LB-24	Single Face Adder	24 1/4"	10 1/8"	48"	9 1/2"	2	3			\$ 819	
DM-4812-S-LB-24	Single Face Starter	25 1/4"	12 1/8"	48"	11 1/2"	2	3			\$ 1,175	
DM-4812-A-LB-24	Single Face Adder	24 1/4"	12 1/8"	48"	11 1/2"	2	3			\$ 850	
DM-4810-S-LB-30	Single Face Starter	31 1/4"	10 1/8"	48"	9 1/2"	2	3			\$ 1,144	
DM-4810-A-LB-30	Single Face Adder	30 1/4"	10 1/8"	48"	9 1/2"	2	3			\$ 819	
DM-4812-S-LB-30	Single Face Starter	31 1/4"	12 1/8"	48"	11 1/2"	2	3			\$ 1,175	
DM-4812-A-LB-30	Single Face Adder	30 1/4"	12 1/8"	48"	11 1/2"	2	3			\$ 850	
DM-4810-S-LB-36	Single Face Starter	37 1/4"	10 1/8"	48"	9 1/2"	2	3	74.8 Lbs.	5 Cu Ft	\$ 981	
DM-4810-A-LB-36	Single Face Adder	36 1/4"	10 1/8"	48"	9 1/2"	2	3	65.5 Lbs.	5 Cu Ft	\$ 669	
DM-4812-S-LB-36	Single Face Starter	37 1/4"	12 1/8"	48"	11 1/2"	2	3	82.8 Lbs.	6 Cu Ft	\$ 1,025	
DM-4812-A-LB-36	Single Face Adder	36 1/4"	12 1/8"	48"	11 1/2"	2	3	71.3 Lbs.	6 Cu Ft	\$ 694	
DM-6010-S-LB-24	Single Face Starter	25 1/4"	10 1/8"	60"	9 1/2"	3	4			\$ 1,163	
DM-6010-A-LB-24	Single Face Adder	24 1/4"	10 1/8"	60"	9 1/2"	3	4			\$ 856	
DM-6012-S-LB-24	Single Face Starter	25 1/4"	12 1/8"	60"	11 1/2"	3	4			\$ 1,200	
DM-6012-A-LB-24	Single Face Adder	24 1/4"	12 1/8"	60"	11 1/2"	3	4			\$ 888	
DM-6010-S-LB-30	Single Face Starter	31 1/4"	10 1/8"	60"	9 1/2"	3	4			\$ 1,163	
DM-6010-A-LB-30	Single Face Adder	30 1/4"	10 1/8"	60"	9 1/2"	3	4			\$ 856	
DM-6012-S-LB-30	Single Face Starter	31 1/4"	12 1/8"	60"	11 1/2"	3	4			\$ 1,200	
DM-6012-A-LB-30	Single Face Adder	30 1/4"	12 1/8"	60"	11 1/2"	3	4			\$ 888	
DM-6010-S-LB-36	Single Face Starter	37 1/4"	10 1/8"	60"	9 1/2"	3	4	100 Lbs.	6 Cu Ft	\$ 1,006	
DM-6010-A-LB-36	Single Face Adder	36 1/4"	10 1/8"	60"	9 1/2"	3	4	86.3 Lbs.	6 Cu Ft	\$ 700	
DM-6012-S-LB-36	Single Face Starter	37 1/4"	12 1/8"	60"	11 1/2"	3	4	116 Lbs.	8 Cu Ft	\$ 1,044	
DM-6012-A-LB-36	Single Face Adder	36 1/4"	12 1/8"	60"	11 1/2"	3	4	95.5 Lbs.	7 Cu Ft	\$ 731	



Model Shown
DM-3612-S-LB-36



Model Shown
DM-3612-A-LB-36





Model Shown
DM-6012-S-LB-36



Model Shown
DM-6012-A-LB-36

SHELVING

MODEL NUMBER	PRODUCT	WIDTH	DEPTH	HEIGHT	SHELF DEPTH	# OF SHELVES	# OF OPENINGS	WEIGHT	VOLUME	LIST PRICE	DESCRIPTION
	DM-7210-S-LB-24	Single Face Starter	25 1/4"	10 1/8"	72"	9 1/2"	4			\$ 1,231	End, Mid, Top and Base Panels to be constructed from 1" thick 11-ply solid core, veneered 2 sides. Vertical, top and bottom edges banded with 1/4" external hardwood edging, edges to be eased. Front Edge: 3/4" thick x 2 1/2" high fascia - tongue and grooved to top.
	DM-7210-A-LB-24	Single Face Adder	24 1/4"	10 1/8"	72"	9 1/2"	4			\$ 925	
	DM-7212-S-LB-24	Single Face Starter	25 1/4"	12 1/8"	72"	11 1/2"	4			\$ 1,281	
	DM-7212-A-LB-24	Single Face Adder	24 1/4"	12 1/8"	72"	11 1/2"	4			\$ 969	
	DM-7210-S-LB-30	Single Face Starter	31 1/4"	10 1/8"	72"	9 1/2"	4			\$ 1,231	
	DM-7210-A-LB-30	Single Face Adder	30 1/4"	10 1/8"	72"	9 1/2"	4			\$ 925	
	DM-7212-S-LB-30	Single Face Starter	31 1/4"	12 1/8"	72"	11 1/2"	4			\$ 1,281	
	DM-7212-A-LB-30	Single Face Adder	30 1/4"	12 1/8"	72"	11 1/2"	4			\$ 969	
	DM-7210-S-LB-36	Single Face Starter	37 1/4"	10 1/8"	72"	9 1/2"	4			\$ 1,075	
	DM-7210-A-LB-36	Single Face Adder	36 1/4"	10 1/8"	72"	9 1/2"	4	115 Lbs.	7 Cu Ft	\$ 769	
	DM-7212-S-LB-36	Single Face Starter	37 1/4"	12 1/8"	72"	11 1/2"	4	96.6 Lbs.	7 Cu Ft	\$ 1,131	
	DM-7212-A-LB-36	Single Face Adder	36 1/4"	12 1/8"	72"	11 1/2"	4	131 Lbs.	8 Cu Ft	\$ 819	
							5	109 Lbs.	8 Cu Ft		
	DM-8210-S-LB-24	Single Face Starter	25 1/4"	10 1/8"	82"	9 1/2"	5			\$ 1,306	
	DM-8210-A-LB-24	Single Face Adder	24 1/4"	10 1/8"	82"	9 1/2"	5			\$ 1,006	
	DM-8212-S-LB-24	Single Face Starter	25 1/4"	12 1/8"	82"	11 1/2"	5			\$ 1,363	
	DM-8212-A-LB-24	Single Face Adder	24 1/4"	12 1/8"	82"	11 1/2"	5			\$ 1,044	
	DM-8210-S-LB-30	Single Face Starter	31 1/4"	10 1/8"	82"	9 1/2"	5			\$ 1,306	
	DM-8210-A-LB-30	Single Face Adder	30 1/4"	10 1/8"	82"	9 1/2"	5			\$ 1,006	
	DM-8212-S-LB-30	Single Face Starter	31 1/4"	12 1/8"	82"	11 1/2"	5			\$ 1,363	
	DM-8212-A-LB-30	Single Face Adder	30 1/4"	12 1/8"	82"	11 1/2"	5			\$ 1,044	
	DM-8210-S-LB-36	Single Face Starter	37 1/4"	10 1/8"	82"	9 1/2"	5			\$ 1,156	
	DM-8210-A-LB-36	Single Face Adder	36 1/4"	10 1/8"	82"	9 1/2"	5	129 Lbs.	8 Cu Ft	\$ 850	
	DM-8212-S-LB-36	Single Face Starter	37 1/4"	12 1/8"	82"	11 1/2"	5	107 Lbs.	7 Cu Ft	\$ 1,206	
	DM-8212-A-LB-36	Single Face Adder	36 1/4"	12 1/8"	82"	11 1/2"	5	145 Lbs.	9 Cu Ft	\$ 894	
							6	122 Lbs.	8 Cu Ft		

Model Shown
DM-7212-S-LB-36

Model Shown
DM-7212-A-LB-36

Model Shown
DM-8212-S-LB-36

Model Shown
DM-8212-A-LB-36

SHELVING

MODEL NUMBER	PRODUCT	WIDTH	DEPTH	HEIGHT	SHELF DEPTH	# OF SHELVES	# OF OPENINGS	WEIGHT	VOLUME	LIST PRICE	DESCRIPTION
DM-9610-S-LB-24	Single Face Starter	25 1/4"	10 1/8"	96"	9 1/2"	6	7			\$ 1,375	End, Mid, Top and Base Panels to be constructed from 1" thick 11-ply solid core, veneered 2 sides. Vertical, top and bottom edges banded with 1/4" external hardwood edging, edges to be eased. Front Edge: 3/4" thick x 2 1/2" high fascia - tongue and grooved to top.
DM-9610-A-LB-24	Single Face Adder	24 1/4"	10 1/8"	96"	9 1/2"	6	7			\$ 1,069	
DM-9612-S-LB-24	Single Face Starter	25 1/4"	12 1/8"	96"	11 1/2"	6	7			\$ 1,444	
DM-9612-A-LB-24	Single Face Adder	24 1/4"	12 1/8"	96"	11 1/2"	6	7			\$ 1,150	
DM-9610-S-LB-30	Single Face Starter	31 1/4"	10 1/8"	96"	9 1/2"	6	7			\$ 1,375	
DM-9610-A-LB-30	Single Face Adder	30 1/4"	10 1/8"	96"	9 1/2"	6	7			\$ 1,069	
DM-9612-S-LB-30	Single Face Starter	31 1/4"	12 1/8"	96"	11 1/2"	6	7			\$ 1,444	
DM-9612-A-LB-30	Single Face Adder	30 1/4"	12 1/8"	96"	11 1/2"	6	7			\$ 1,150	
DM-9610-S-LB-36	Single Face Starter	37 1/4"	10 1/8"	96"	9 1/2"	6	7	156 Lbs.	9 Cu Ft	\$ 1,225	
DM-9610-A-LB-36	Single Face Adder	36 1/4"	10 1/8"	96"	9 1/2"	6	7	128 Lbs.	8 Cu Ft	\$ 913	
DM-9612-S-LB-36	Single Face Starter	37 1/4"	12 1/8"	96"	11 1/2"	6	7	177 Lbs.	10 Cu Ft	\$ 1,294	
DM-9612-A-LB-36	Single Face Adder	36 1/4"	12 1/8"	96"	11 1/2"	6	7	145 Lbs.	9 Cu Ft	\$ 1,000	











Model Shown
DM-9612-S-LB-36

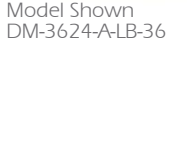
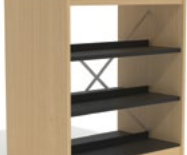





Model Shown
DM-9612-A-LB-36

SHELVING

	MODEL NUMBER	PRODUCT	WIDTH	DEPTH	HEIGHT	SHELF DEPTH	# OF SHELVES	# OF OPENINGS	WEIGHT	VOLUME	LIST PRICE	DESCRIPTION
 Model Shown DM-3624-S-LB-36	DM-3620-S-LB-24	Double Face Starter	25 1/4"	19 1/2"	36"	9 1/2"	2	4			\$ 1,850	End, Mid, Top and Base Panels to be constructed from 1" thick 11-ply solid core, veneered 2 sides. Vertical, top and bottom edges banded with 1/4" external hardwood edging, edges to be eased. Front Edge: 3/4" thick x 2 1/2" high fascia - tongue and grooved to top.
	DM-3620-A-LB-24	Double Face Adder	24 1/4"	19 1/2"	36"	9 1/2"	2	4			\$ 1,325	
	DM-3624-S-LB-24	Double Face Starter	25 1/4"	23 1/2"	36"	11 1/2"	2	4			\$ 1,881	
	DM-3624-A-LB-24	Double Face Adder	24 1/4"	23 1/2"	36"	11 1/2"	2	4			\$ 1,338	
 Model Shown DM-3624-A-LB-36	DM-3620-S-LB-30	Double Face Starter	31 1/4"	19 1/2"	36"	9 1/2"	2	4			\$ 1,850	
	DM-3620-A-LB-30	Double Face Adder	30 1/4"	19 1/2"	36"	9 1/2"	2	4			\$ 1,325	
	DM-3624-S-LB-30	Double Face Starter	31 1/4"	23 1/2"	36"	11 1/2"	2	4			\$ 1,881	
	DM-3624-A-LB-30	Double Face Adder	30 1/4"	23 1/2"	36"	11 1/2"	2	4			\$ 1,338	
 Model Shown DM-3624-A-LB-36	DM-3620-S-LB-36	Double Face Starter	37 1/4"	19 1/2"	36"	9 1/2"	2	4	88.6 Lbs.	7 Cu Ft	\$ 1,619	
	DM-3620-A-LB-36	Double Face Adder	36 1/4"	19 1/2"	36"	9 1/2"	2	4	73.6 Lbs.	6 Cu Ft	\$ 1,088	
	DM-3624-S-LB-36	Double Face Starter	37 1/4"	23 1/2"	36"	11 1/2"	2	4	110 Lbs.	10 Cu Ft	\$ 1,656	
	DM-3624-A-LB-36	Double Face Adder	36 1/4"	23 1/2"	36"	11 1/2"	2	4	88.6 Lbs.	9 Cu Ft	\$ 1,106	
 Model Shown DM-3624-S-LB-36	DM-4220-S-LB-24	Double Face Starter	25 1/4"	19 1/2"	42"	9 1/2"	4	6			\$ 1,894	
	DM-4220-A-LB-24	Double Face Adder	24 1/4"	19 1/2"	42"	9 1/2"	4	6			\$ 1,356	
	DM-4224-S-LB-24	Double Face Starter	25 1/4"	23 1/2"	42"	11 1/2"	4	6			\$ 1,931	
	DM-4224-A-LB-24	Double Face Adder	24 1/4"	23 1/2"	42"	11 1/2"	4	6			\$ 1,369	
 Model Shown DM-3624-A-LB-36	DM-4220-S-LB-30	Double Face Starter	31 1/4"	19 1/2"	42"	9 1/2"	4	6			\$ 1,894	
	DM-4220-A-LB-30	Double Face Adder	30 1/4"	19 1/2"	42"	9 1/2"	4	6			\$ 1,356	
	DM-4224-S-LB-30	Double Face Starter	31 1/4"	23 1/2"	42"	11 1/2"	4	6			\$ 1,931	
	DM-4224-A-LB-30	Double Face Adder	30 1/4"	23 1/2"	42"	11 1/2"	4	6			\$ 1,369	
 Model Shown DM-3624-A-LB-36	DM-4220-S-LB-36	Double Face Starter	37 1/4"	19 1/2"	42"	9 1/2"	4	6	94 Lbs.	7 Cu Ft	\$ 1,663	
	DM-4220-A-LB-36	Double Face Adder	36 1/4"	19 1/2"	42"	9 1/2"	4	6	78 Lbs.	7 Cu Ft	\$ 1,119	
	DM-4224-S-LB-36	Double Face Starter	37 1/4"	23 1/2"	42"	11 1/2"	4	6	115 Lbs.	10 Cu Ft	\$ 1,700	
	DM-4224-A-LB-36	Double Face Adder	36 1/4"	23 1/2"	42"	11 1/2"	4	6	113 Lbs.	10 Cu Ft	\$ 1,144	

MODEL NUMBER	PRODUCT	WIDTH	DEPTH	HEIGHT	SHELF DEPTH	# OF SHELVES	# OF OPENINGS	WEIGHT	VOLUME	LIST PRICE	DESCRIPTION
 Model Shown DM-3624-S-LB-36	DM-4820-S-LB-24	Double Face Starter	25 1/4"	19 1/2"	48"	9 1/2"	4			\$ 1,963	End, Mid, Top and Base Panels to be constructed from 1" thick 11-ply solid core, veneered 2 sides. Vertical, top and bottom edges banded with 1/4" external hardwood edging, edges to be eased. Front Edge: 3/4" thick x 2 1/2" high fascia - tongue and grooved to top.
	DM-4820-A-LB-24	Double Face Adder	24 1/4"	19 1/2"	48"	9 1/2"	4			\$ 1,575	
	DM-4824-S-LB-24	Double Face Starter	25 1/4"	23 1/2"	48"	11 1/2"	4			\$ 2,156	
	DM-4824-A-LB-24	Double Face Adder	24 1/4"	23 1/2"	48"	11 1/2"	4			\$ 1,606	
DM-4820-S-LB-30	Double Face Starter	31 1/4"	19 1/2"	48"	9 1/2"	4			\$ 1,963		
DM-4820-A-LB-30	Double Face Adder	30 1/4"	19 1/2"	48"	9 1/2"	4			\$ 1,575		
DM-4824-S-LB-30	Double Face Starter	31 1/4"	23 1/2"	48"	11 1/2"	4			\$ 2,156		
DM-4824-A-LB-30	Double Face Adder	30 1/4"	23 1/2"	48"	11 1/2"	4			\$ 1,606		
 Model Shown DM-3624-A-LB-36	DM-4820-S-LB-36	Double Face Starter	37 1/4"	19 1/2"	48"	9 1/2"	4			\$ 1,875	
	DM-4820-A-LB-36	Double Face Adder	36 1/4"	19 1/2"	48"	9 1/2"	4	132 Lbs.	9 Cu Ft	\$ 1,350	
	DM-4824-S-LB-36	Double Face Starter	37 1/4"	23 1/2"	48"	11 1/2"	4	109 Lbs.	8 Cu Ft	\$ 1,919	
	DM-4824-A-LB-36	Double Face Adder	36 1/4"	23 1/2"	48"	11 1/2"	4	155 Lbs.	11 Cu Ft	\$ 1,375	
 Model Shown DM-6024-S-LB-36	DM-6020-S-LB-24	Double Face Starter	25 1/4"	19 1/2"	60"	9 1/2"	6			\$ 2,181	
	DM-6020-A-LB-24	Double Face Adder	24 1/4"	19 1/2"	60"	9 1/2"	6			\$ 1,638	
	DM-6024-S-LB-24	Double Face Starter	25 1/4"	23 1/2"	60"	11 1/2"	6			\$ 2,225	
	DM-6024-A-LB-24	Double Face Adder	24 1/4"	23 1/2"	60"	11 1/2"	6			\$ 1,688	
	DM-6020-S-LB-30	Double Face Starter	31 1/4"	19 1/2"	60"	9 1/2"	6			\$ 2,181	
	DM-6020-A-LB-30	Double Face Adder	30 1/4"	19 1/2"	60"	9 1/2"	6			\$ 1,638	
	DM-6024-S-LB-30	Double Face Starter	31 1/4"	23 1/2"	60"	11 1/2"	6			\$ 2,225	
	DM-6024-A-LB-30	Double Face Adder	30 1/4"	23 1/2"	60"	11 1/2"	6			\$ 1,688	
 Model Shown DM-6024-A-LB-36	DM-6020-S-LB-36	Double Face Starter	37 1/4"	19 1/2"	60"	9 1/2"	6			\$ 1,956	
	DM-6020-A-LB-36	Double Face Adder	36 1/4"	19 1/2"	60"	9 1/2"	6	176 Lbs.	11 Cu Ft	\$ 1,400	
	DM-6024-S-LB-36	Double Face Starter	37 1/4"	23 1/2"	60"	11 1/2"	6	145 Lbs.	10 Cu Ft	\$ 1,994	
	DM-6024-A-LB-36	Double Face Adder	36 1/4"	23 1/2"	60"	11 1/2"	6	200 Lbs.	12 Cu Ft	\$ 1,456	

MODEL NUMBER	PRODUCT	WIDTH	DEPTH	HEIGHT	SHELF DEPTH	# OF SHELVES	# OF OPENINGS	WEIGHT	VOLUME	LIST PRICE	DESCRIPTION	
 Model Shown DM-7224-S-LB-36  Model Shown DM-7224-A-LB-36  Model Shown DM-8224-S-LB-36  Model Shown DM-8224-A-LB-36	DM-7220-S-LB-24	Double Face Starter	25 1/4"	19 1/2"	72"	9 1/2"	8			\$ 2,338	End, Mid, Top and Base Panels to be constructed from 1" thick 11-ply solid core, veneered 2 sides. Vertical, top and bottom edges banded with 1/4" external hardwood edging, edges to be eased. Front Edge: 3/4" thick x 2 1/2" high fascia - tongue and grooved to top.	
	DM-7220-A-LB-24	Double Face Adder	24 1/4"	19 1/2"	72"	9 1/2"	8			\$ 1,781		
	DM-7224-S-LB-24	Double Face Starter	25 1/4"	23 1/2"	72"	11 1/2"	8			\$ 2,388		
	DM-7224-A-LB-24	Double Face Adder	24 1/4"	23 1/2"	72"	11 1/2"	8			\$ 1,838		
	DM-7220-S-LB-30	Double Face Starter	31 1/4"	19 1/2"	72"	9 1/2"	8			\$ 2,338		
	DM-7220-A-LB-30	Double Face Adder	30 1/4"	19 1/2"	72"	9 1/2"	8			\$ 1,781		
	DM-7224-S-LB-30	Double Face Starter	31 1/4"	23 1/2"	72"	11 1/2"	8			\$ 2,388		
	DM-7224-A-LB-30	Double Face Adder	30 1/4"	23 1/2"	72"	11 1/2"	8			\$ 1,838		
	DM-7220-S-LB-36	Double Face Starter	37 1/4"	19 1/2"	72"	9 1/2"	8	10	200 Lbs.	12 Cu Ft		\$ 2,106
	DM-7220-A-LB-36	Double Face Adder	36 1/4"	19 1/2"	72"	9 1/2"	8	10	164 Lbs.	11 Cu Ft		\$ 1,550
	DM-7224-S-LB-36	Double Face Starter	37 1/4"	23 1/2"	72"	11 1/2"	8	10	229 Lbs.	13 Cu Ft		\$ 2,156
	DM-7224-A-LB-36	Double Face Adder	36 1/4"	23 1/2"	72"	11 1/2"	8	10	186 Lbs.	12 Cu Ft		\$ 1,606
	DM-8220-S-LB-24	Double Face Starter	25 1/4"	19 1/2"	82"	9 1/2"	10	12				\$ 2,475
	DM-8220-A-LB-24	Double Face Adder	24 1/4"	19 1/2"	82"	9 1/2"	10	12				\$ 1,931
	DM-8224-S-LB-24	Double Face Starter	25 1/4"	23 1/2"	82"	11 1/2"	10	12				\$ 2,538
	DM-8224-A-LB-24	Double Face Adder	24 1/4"	23 1/2"	82"	11 1/2"	10	12				\$ 2,000
	DM-8220-S-LB-30	Double Face Starter	31 1/4"	19 1/2"	82"	9 1/2"	10	12				\$ 2,475
	DM-8220-A-LB-30	Double Face Adder	30 1/4"	19 1/2"	82"	9 1/2"	10	12				\$ 1,931
	DM-8224-S-LB-30	Double Face Starter	31 1/4"	23 1/2"	82"	11 1/2"	10	12				\$ 2,538
	DM-8224-A-LB-30	Double Face Adder	30 1/4"	23 1/2"	82"	11 1/2"	10	12				\$ 2,000
	DM-8220-S-LB-36	Double Face Starter	37 1/4"	19 1/2"	82"	9 1/2"	10	12	224 Lbs.	12 Cu Ft		\$ 2,238
	DM-8220-A-LB-36	Double Face Adder	36 1/4"	19 1/2"	82"	9 1/2"	10	12	184 Lbs.	11 Cu Ft		\$ 1,700
	DM-8224-S-LB-36	Double Face Starter	37 1/4"	23 1/2"	82"	11 1/2"	10	12	256 Lbs.	14 Cu Ft		\$ 2,313
	DM-8224-A-LB-36	Double Face Adder	36 1/4"	23 1/2"	82"	11 1/2"	10	12	207 Lbs.	12 Cu Ft		\$ 1,769

MODEL NUMBER	PRODUCT	WIDTH	DEPTH	HEIGHT	SHELF DEPTH	# OF SHELVES	# OF OPENINGS	WEIGHT	VOLUME	LIST PRICE	DESCRIPTION
DM-9620-S-LB-24	Double Face Starter	25 1/4"	19 1/2"	96"	9 1/2"	12	14			\$ 2,625	End, Mid, Top and Base Panels to be constructed from 1" thick 11-ply solid core, veneered 2 sides. Vertical, top and bottom edges banded with 1/4" external hardwood edging, edges to be eased. Front Edge: 3/4" thick x 2 1/2" high fascia - tongue and grooved to top.
DM-9620-A-LB-24	Double Face Adder	24 1/4"	19 1/2"	96"	9 1/2"	12	14			\$ 2,069	
DM-9624-S-LB-24	Double Face Starter	25 1/4"	23 1/2"	96"	11 1/2"	12	14			\$ 2,694	
DM-9624-A-LB-24	Double Face Adder	24 1/4"	23 1/2"	96"	11 1/2"	12	14			\$ 2,156	
DM-9620-S-LB-30	Double Face Starter	31 1/4"	19 1/2"	96"	9 1/2"	12	14			\$ 2,625	
DM-9620-A-LB-30	Double Face Adder	30 1/4"	19 1/2"	96"	9 1/2"	12	14			\$ 2,069	
DM-9624-S-LB-30	Double Face Starter	31 1/4"	23 1/2"	96"	11 1/2"	12	14			\$ 2,694	
DM-9624-A-LB-30	Double Face Adder	30 1/4"	23 1/2"	96"	11 1/2"	12	14			\$ 2,156	
DM-9620-S-LB-36	Double Face Starter	37 1/4"	19 1/2"	96"	9 1/2"	12	14	276 Lbs.	13 Cu Ft	\$ 2,388	
DM-9620-A-LB-36	Double Face Adder	36 1/4"	19 1/2"	96"	9 1/2"	12	14	220 Lbs.	12 Cu Ft	\$ 1,844	
DM-9624-S-LB-36	Double Face Starter	37 1/4"	23 1/2"	96"	11 1/2"	12	14	315 Lbs.	15 Cu Ft	\$ 2,463	
DM-9624-A-LB-36	Double Face Adder	36 1/4"	23 1/2"	96"	11 1/2"	12	14	247 Lbs.	13 Cu Ft	\$ 1,919	















Model Shown
DM-9624-S-LB-36



Model Shown
DM-9624-A-LB-36

SHELVING

	MODEL NUMBER	PRODUCT	WIDTH	DEPTH	HEIGHT	SHELF DEPTH	# OF SHELVES	# OF OPENINGS	WEIGHT	VOLUME	LIST PRICE	DESCRIPTION
 Model Shown DM-3612-S-LB-36-IPT	DM-3610-S-LB-24-IPT	Single Face Starter	25 ¹ / ₄ "	10 ¹ / ₈ "	36"	9 ¹ / ₂ "	1	2			\$ 1,119	End, Mid, Top and Base Panels to be constructed from 1" thick 11-ply solid core, veneered 2 sides. Vertical, top and bottom edges banded with 1/4" external hardwood edging, edges to be eased. Front Edge: 3/4" thick x 2 1/2" high fascia - tongue and grooved to top.
	DM-3610-A-LB-24-IPT	Single Face Adder	24 ¹ / ₄ "	10 ¹ / ₈ "	36"	9 ¹ / ₂ "	1	2			\$ 819	
	DM-3612-S-LB-24-IPT	Single Face Starter	25 ¹ / ₄ "	12 ¹ / ₈ "	36"	11 ¹ / ₂ "	1	2			\$ 1,169	
	DM-3612-A-LB-24-IPT	Single Face Adder	24 ¹ / ₄ "	12 ¹ / ₈ "	36"	11 ¹ / ₂ "	1	2			\$ 844	
 Model Shown DM-3612-S-LB-36-IPT	DM-3610-S-LB-30-IPT	Single Face Starter	31 ¹ / ₄ "	10 ¹ / ₈ "	36"	9 ¹ / ₂ "	1	2			\$ 1,119	
	DM-3610-A-LB-30-IPT	Single Face Adder	30 ¹ / ₄ "	10 ¹ / ₈ "	36"	9 ¹ / ₂ "	1	2			\$ 819	
	DM-3612-S-LB-30-IPT	Single Face Starter	31 ¹ / ₄ "	12 ¹ / ₈ "	36"	11 ¹ / ₂ "	1	2			\$ 1,169	
	DM-3612-A-LB-30-IPT	Single Face Adder	30 ¹ / ₄ "	12 ¹ / ₈ "	36"	11 ¹ / ₂ "	1	2			\$ 844	
 Model Shown DM-3612-A-LB-36-IPT	DM-3610-S-LB-36-IPT	Single Face Starter	37 ¹ / ₄ "	10 ¹ / ₈ "	36"	9 ¹ / ₂ "	1	2	50.6 Lbs.	4 Cu Ft	\$ 969	
	DM-3610-A-LB-36-IPT	Single Face Adder	36 ¹ / ₄ "	10 ¹ / ₈ "	36"	9 ¹ / ₂ "	1	2	46 Lbs.	4 Cu Ft	\$ 656	
	DM-3612-S-LB-36-IPT	Single Face Starter	37 ¹ / ₄ "	12 ¹ / ₈ "	36"	11 ¹ / ₂ "	1	2	50.6 Lbs.	5 Cu Ft	\$ 1,013	
	DM-3612-A-LB-36-IPT	Single Face Adder	36 ¹ / ₄ "	12 ¹ / ₈ "	36"	11 ¹ / ₂ "	1	2	47.2 Lbs.	5 Cu Ft	\$ 694	
 Model Shown DM-4212-S-LB-36-IPT	DM-4210-S-LB-24-IPT	Single Face Starter	25 ¹ / ₄ "	10 ¹ / ₈ "	42"	9 ¹ / ₂ "	2	3			\$ 1,194	
	DM-4210-A-LB-24-IPT	Single Face Adder	24 ¹ / ₄ "	10 ¹ / ₈ "	42"	9 ¹ / ₂ "	2	3			\$ 894	
	DM-4212-S-LB-24-IPT	Single Face Starter	25 ¹ / ₄ "	12 ¹ / ₈ "	42"	11 ¹ / ₂ "	2	3			\$ 1,238	
	DM-4212-A-LB-24-IPT	Single Face Adder	24 ¹ / ₄ "	12 ¹ / ₈ "	42"	11 ¹ / ₂ "	2	3			\$ 925	
 Model Shown DM-4212-S-LB-36-IPT	DM-4210-S-LB-30-IPT	Single Face Starter	31 ¹ / ₄ "	10 ¹ / ₈ "	42"	9 ¹ / ₂ "	2	3			\$ 1,194	
	DM-4210-A-LB-30-IPT	Single Face Adder	30 ¹ / ₄ "	10 ¹ / ₈ "	42"	9 ¹ / ₂ "	2	3			\$ 894	
	DM-4212-S-LB-30-IPT	Single Face Starter	31 ¹ / ₄ "	12 ¹ / ₈ "	42"	11 ¹ / ₂ "	2	3			\$ 1,238	
	DM-4212-A-LB-30-IPT	Single Face Adder	30 ¹ / ₄ "	12 ¹ / ₈ "	42"	11 ¹ / ₂ "	2	3			\$ 925	
 Model Shown DM-4212-A-LB-36-IPT	DM-4210-S-LB-36-IPT	Single Face Starter	37 ¹ / ₄ "	10 ¹ / ₈ "	42"	9 ¹ / ₂ "	2	3	55 Lbs.	5 Cu Ft	\$ 1,044	
	DM-4210-A-LB-36-IPT	Single Face Adder	36 ¹ / ₄ "	10 ¹ / ₈ "	42"	9 ¹ / ₂ "	2	3	52 Lbs.	5 Cu Ft	\$ 713	
	DM-4212-S-LB-36-IPT	Single Face Starter	37 ¹ / ₄ "	12 ¹ / ₈ "	42"	11 ¹ / ₂ "	2	3	60 Lbs.	5 Cu Ft	\$ 1,088	
	DM-4212-A-LB-36-IPT	Single Face Adder	36 ¹ / ₄ "	12 ¹ / ₈ "	42"	11 ¹ / ₂ "	2	3	53 Lbs.	5 Cu Ft	\$ 769	

	MODEL NUMBER	PRODUCT	WIDTH	DEPTH	HEIGHT	SHELF DEPTH	# OF SHELVES	# OF OPENINGS	WEIGHT	VOLUME	LIST PRICE	DESCRIPTION
 <p>Model Shown DM-4212-S-LB-36-IPT</p>	DM-4810-S-LB-24-IPT	Single Face Starter	25 1/4"	10 1/8"	48"	9 1/2"	2	3			\$ 1,219	End, Mid, Top and Base Panels to be constructed from 1" thick 11-ply solid core, veneered 2 sides. Vertical, top and bottom edges banded with 1/4" external hardwood edging, edges to be eased. Front Edge: 3/4" thick x 2 1/2" high fascia - tongue and grooved to top.
	DM-4810-A-LB-24-IPT	Single Face Adder	24 1/4"	10 1/8"	48"	9 1/2"	2	3			\$ 900	
	DM-4812-S-LB-24-IPT	Single Face Starter	25 1/4"	12 1/8"	48"	11 1/2"	2	3			\$ 1,250	
	DM-4812-A-LB-24-IPT	Single Face Adder	24 1/4"	12 1/8"	48"	11 1/2"	2	3			\$ 925	
 <p>Model Shown DM-4212-A-LB-36-IPT</p>	DM-4810-S-LB-30-IPT	Single Face Starter	31 1/4"	10 1/8"	48"	9 1/2"	2	3			\$ 1,219	
	DM-4810-A-LB-30-IPT	Single Face Adder	30 1/4"	10 1/8"	48"	9 1/2"	2	3			\$ 900	
	DM-4812-S-LB-30-IPT	Single Face Starter	31 1/4"	12 1/8"	48"	11 1/2"	2	3			\$ 1,250	
	DM-4812-A-LB-30-IPT	Single Face Adder	30 1/4"	12 1/8"	48"	11 1/2"	2	3			\$ 925	
 <p>Model Shown DM-4212-S-LB-36-IPT</p>	DM-4810-S-LB-36-IPT	Single Face Starter	37 1/4"	10 1/8"	48"	9 1/2"	2	3	74.8 Lbs.	5 Cu Ft	\$ 1,063	
	DM-4810-A-LB-36-IPT	Single Face Adder	36 1/4"	10 1/8"	48"	9 1/2"	2	3	65.5 Lbs.	5 Cu Ft	\$ 744	
	DM-4812-S-LB-36-IPT	Single Face Starter	37 1/4"	12 1/8"	48"	11 1/2"	2	3	82.8 Lbs.	6 Cu Ft	\$ 1,100	
	DM-4812-A-LB-36-IPT	Single Face Adder	36 1/4"	12 1/8"	48"	11 1/2"	2	3	71.3 Lbs.	6 Cu Ft	\$ 769	
 <p>Model Shown DM-6012-S-LB-36-IPT</p>	DM-6010-S-LB-24-IPT	Single Face Starter	25 1/4"	10 1/8"	60"	9 1/2"	3	4			\$ 1,238	
	DM-6010-A-LB-24-IPT	Single Face Adder	24 1/4"	10 1/8"	60"	9 1/2"	3	4			\$ 931	
	DM-6012-S-LB-24-IPT	Single Face Starter	25 1/4"	12 1/8"	60"	11 1/2"	3	4			\$ 1,269	
	DM-6012-A-LB-24-IPT	Single Face Adder	24 1/4"	12 1/8"	60"	11 1/2"	3	4			\$ 969	
 <p>Model Shown DM-6012-A-LB-36-IPT</p>	DM-6010-S-LB-30-IPT	Single Face Starter	31 1/4"	10 1/8"	60"	9 1/2"	3	4			\$ 1,238	
	DM-6010-A-LB-30-IPT	Single Face Adder	30 1/4"	10 1/8"	60"	9 1/2"	3	4			\$ 931	
	DM-6012-S-LB-30-IPT	Single Face Starter	31 1/4"	12 1/8"	60"	11 1/2"	3	4			\$ 1,269	
	DM-6012-A-LB-30-IPT	Single Face Adder	30 1/4"	12 1/8"	60"	11 1/2"	3	4			\$ 969	
 <p>Model Shown DM-6012-S-LB-36-IPT</p>	DM-6010-S-LB-36-IPT	Single Face Starter	37 1/4"	10 1/8"	60"	9 1/2"	3	4	100 Lbs.	6 Cu Ft	\$ 1,081	
	DM-6010-A-LB-36-IPT	Single Face Adder	36 1/4"	10 1/8"	60"	9 1/2"	3	4	86.3 Lbs.	6 Cu Ft	\$ 775	
	DM-6012-S-LB-36-IPT	Single Face Starter	37 1/4"	12 1/8"	60"	11 1/2"	3	4	116 Lbs.	8 Cu Ft	\$ 1,119	
	DM-6012-A-LB-36-IPT	Single Face Adder	36 1/4"	12 1/8"	60"	11 1/2"	3	4	95.5 Lbs.	7 Cu Ft	\$ 806	

MODEL NUMBER	PRODUCT	WIDTH	DEPTH	HEIGHT	SHELF DEPTH	# OF SHELVES	# OF OPENINGS	WEIGHT	VOLUME	LIST PRICE	DESCRIPTION
--------------	---------	-------	-------	--------	-------------	--------------	---------------	--------	--------	------------	-------------



Model Shown
DM-3624-S-LB-36-IPT

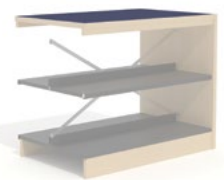

Model Shown
DM-3624-A-LB-36-IPT

DM-3620-S-LB-24-IPT	Double Face Starter	25 ¹ / ₄ "	19 ¹ / ₂ "	36"	9 ¹ / ₂ "	2	4			\$ 2,000	End, Mid, Top and Base Panels to be constructed from 1" thick 11-ply solid core, veneered 2 sides. Vertical, top and bottom edges banded with 1/4" external hardwood edging, edges to be eased. Front Edge: 3/4" thick x 2 1/2" high fascia - tongue and grooved to top.
DM-3620-A-LB-24-IPT	Double Face Adder	24 ¹ / ₄ "	19 ¹ / ₂ "	36"	9 ¹ / ₂ "	2	4			\$ 1,481	
DM-3624-S-LB-24-IPT	Double Face Starter	25 ¹ / ₄ "	23 ¹ / ₂ "	36"	11 ¹ / ₂ "	2	4			\$ 2,038	
DM-3624-A-LB-24-IPT	Double Face Adder	24 ¹ / ₄ "	23 ¹ / ₂ "	36"	11 ¹ / ₂ "	2	4			\$ 1,494	
DM-3620-S-LB-30-IPT	Double Face Starter	31 ¹ / ₄ "	19 ¹ / ₂ "	36"	9 ¹ / ₂ "	2	4			\$ 2,000	
DM-3620-A-LB-30-IPT	Double Face Adder	30 ¹ / ₄ "	19 ¹ / ₂ "	36"	9 ¹ / ₂ "	2	4			\$ 1,481	
DM-3624-S-LB-30-IPT	Double Face Starter	31 ¹ / ₄ "	23 ¹ / ₂ "	36"	11 ¹ / ₂ "	2	4			\$ 2,038	
DM-3624-A-LB-30-IPT	Double Face Adder	30 ¹ / ₄ "	23 ¹ / ₂ "	36"	11 ¹ / ₂ "	2	4			\$ 1,494	
DM-3620-S-LB-36-IPT	Double Face Starter	37 ¹ / ₄ "	19 ¹ / ₂ "	36"	9 ¹ / ₂ "	2	4	88.6 Lbs.	7 Cu Ft	\$ 1,769	
DM-3620-A-LB-36-IPT	Double Face Adder	36 ¹ / ₄ "	19 ¹ / ₂ "	36"	9 ¹ / ₂ "	2	4	73.6 Lbs.	6 Cu Ft	\$ 1,244	
DM-3624-S-LB-36-IPT	Double Face Starter	37 ¹ / ₄ "	23 ¹ / ₂ "	36"	11 ¹ / ₂ "	2	4	110 Lbs.	10 Cu Ft	\$ 1,813	
DM-3624-A-LB-36-IPT	Double Face Adder	36 ¹ / ₄ "	23 ¹ / ₂ "	36"	11 ¹ / ₂ "	2	4	88.6 Lbs.	9 Cu Ft	\$ 1,263	







Model Shown
DM-4224-S-LB-36-IPT









Model Shown
DM-4224-A-LB-36-IPT



DM-4220-S-LB-24-IPT	Double Face Starter	25 ¹ / ₄ "	19 ¹ / ₂ "	42"	9 ¹ / ₂ "	4	6			\$ 2,050	
DM-4220-A-LB-24-IPT	Double Face Adder	24 ¹ / ₄ "	19 ¹ / ₂ "	42"	9 ¹ / ₂ "	4	6			\$ 1,513	
DM-4224-S-LB-24-IPT	Double Face Starter	25 ¹ / ₄ "	23 ¹ / ₂ "	42"	11 ¹ / ₂ "	4	6			\$ 2,094	
DM-4224-A-LB-24-IPT	Double Face Adder	24 ¹ / ₄ "	23 ¹ / ₂ "	42"	11 ¹ / ₂ "	4	6			\$ 1,525	
DM-4220-S-LB-30-IPT	Double Face Starter	31 ¹ / ₄ "	19 ¹ / ₂ "	42"	9 ¹ / ₂ "	4	6			\$ 2,050	
DM-4220-A-LB-30-IPT	Double Face Adder	30 ¹ / ₄ "	19 ¹ / ₂ "	42"	9 ¹ / ₂ "	4	6			\$ 1,513	
DM-4224-S-LB-30-IPT	Double Face Starter	31 ¹ / ₄ "	23 ¹ / ₂ "	42"	11 ¹ / ₂ "	4	6			\$ 2,094	
DM-4224-A-LB-30-IPT	Double Face Adder	30 ¹ / ₄ "	23 ¹ / ₂ "	42"	11 ¹ / ₂ "	4	6			\$ 1,525	
DM-4220-S-LB-36-IPT	Double Face Starter	37 ¹ / ₄ "	19 ¹ / ₂ "	42"	9 ¹ / ₂ "	4	6	94 Lbs.	7 Cu Ft	\$ 1,819	
DM-4220-A-LB-36-IPT	Double Face Adder	36 ¹ / ₄ "	19 ¹ / ₂ "	42"	9 ¹ / ₂ "	4	6	78 Lbs.	7 Cu Ft	\$ 1,281	
DM-4224-S-LB-36-IPT	Double Face Starter	37 ¹ / ₄ "	23 ¹ / ₂ "	42"	11 ¹ / ₂ "	4	6	115 Lbs.	10 Cu Ft	\$ 1,856	
DM-4224-A-LB-36-IPT	Double Face Adder	36 ¹ / ₄ "	23 ¹ / ₂ "	42"	11 ¹ / ₂ "	4	6	113 Lbs.	10 Cu Ft	\$ 1,294	

MODEL NUMBER	PRODUCT	WIDTH	DEPTH	HEIGHT	SHELF DEPTH	# OF SHELVES	# OF OPENINGS	WEIGHT	VOLUME	LIST PRICE	DESCRIPTION
 Model Shown DM-4224-S-LB-36-IPT	DM-4820-S-LB-24-IPT	Double Face Starter	25 1/4"	19 1/2"	48"	9 1/2"	4			\$ 2,119	End, Mid, Top and Base Panels to be constructed from 1" thick 11-ply solid core, veneered 2 sides. Vertical, top and bottom edges banded with 1/4" external hardwood edging, edges to be eased. Front Edge: 3/4" thick x 2 1/2" high fascia - tongue and grooved to top.
	DM-4820-A-LB-24-IPT	Double Face Adder	24 1/4"	19 1/2"	48"	9 1/2"	4			\$ 1,731	
	DM-4824-S-LB-24-IPT	Double Face Starter	25 1/4"	23 1/2"	48"	11 1/2"	4			\$ 2,313	
	DM-4824-A-LB-24-IPT	Double Face Adder	24 1/4"	23 1/2"	48"	11 1/2"	4			\$ 1,756	
	DM-4820-S-LB-30-IPT	Double Face Starter	31 1/4"	19 1/2"	48"	9 1/2"	4			\$ 2,119	
	DM-4820-A-LB-30-IPT	Double Face Adder	30 1/4"	19 1/2"	48"	9 1/2"	4			\$ 1,731	
	DM-4824-S-LB-30-IPT	Double Face Starter	31 1/4"	23 1/2"	48"	11 1/2"	4			\$ 2,313	
	DM-4824-A-LB-30-IPT	Double Face Adder	30 1/4"	23 1/2"	48"	11 1/2"	4			\$ 1,756	
 Model Shown DM-4224-A-LB-36-IPT	DM-4820-S-LB-36-IPT	Double Face Starter	37 1/4"	19 1/2"	48"	9 1/2"	4			\$ 2,031	
	DM-4820-A-LB-36-IPT	Double Face Adder	36 1/4"	19 1/2"	48"	9 1/2"	4	132 Lbs.	9 Cu Ft	\$ 2,031	
	DM-4824-S-LB-36-IPT	Double Face Starter	37 1/4"	23 1/2"	48"	11 1/2"	4	109 Lbs.	8 Cu Ft	\$ 1,506	
	DM-4824-A-LB-36-IPT	Double Face Adder	36 1/4"	23 1/2"	48"	11 1/2"	4	155 Lbs.	11 Cu Ft	\$ 2,075	
	DM-4824-A-LB-36-IPT	Double Face Adder	36 1/4"	23 1/2"	48"	11 1/2"	4	127 Lbs.	10 Cu Ft	\$ 1,531	
 Model Shown DM-6024-S-LB-36-IPT	DM-6020-S-LB-24-IPT	Double Face Starter	25 1/4"	19 1/2"	60"	9 1/2"	6			\$ 2,338	
	DM-6020-A-LB-24-IPT	Double Face Adder	24 1/4"	19 1/2"	60"	9 1/2"	6			\$ 1,794	
	DM-6024-S-LB-24-IPT	Double Face Starter	25 1/4"	23 1/2"	60"	11 1/2"	6			\$ 2,381	
	DM-6024-A-LB-24-IPT	Double Face Adder	24 1/4"	23 1/2"	60"	11 1/2"	6			\$ 1,844	
	DM-6020-S-LB-30-IPT	Double Face Starter	31 1/4"	19 1/2"	60"	9 1/2"	6			\$ 2,338	
	DM-6020-A-LB-30-IPT	Double Face Adder	30 1/4"	19 1/2"	60"	9 1/2"	6			\$ 1,794	
	DM-6024-S-LB-30-IPT	Double Face Starter	31 1/4"	23 1/2"	60"	11 1/2"	6			\$ 2,381	
	DM-6024-A-LB-30-IPT	Double Face Adder	30 1/4"	23 1/2"	60"	11 1/2"	6			\$ 1,844	
 Model Shown DM-6024-A-LB-36-IPT	DM-6020-S-LB-36-IPT	Double Face Starter	37 1/4"	19 1/2"	60"	9 1/2"	6			\$ 2,106	
	DM-6020-A-LB-36-IPT	Double Face Adder	36 1/4"	19 1/2"	60"	9 1/2"	6	176 Lbs.	11 Cu Ft	\$ 2,106	
	DM-6024-S-LB-36-IPT	Double Face Starter	37 1/4"	23 1/2"	60"	11 1/2"	6	145 Lbs.	10 Cu Ft	\$ 1,556	
	DM-6024-A-LB-36-IPT	Double Face Adder	36 1/4"	23 1/2"	60"	11 1/2"	6	200 Lbs.	12 Cu Ft	\$ 2,150	
	DM-6024-A-LB-36-IPT	Double Face Adder	36 1/4"	23 1/2"	60"	11 1/2"	6	164 Lbs.	11 Cu Ft	\$ 1,606	

SHELVING

	MODEL NUMBER	PRODUCT	WIDTH	DEPTH	HEIGHT	SHELF DEPTH	# OF SHELVES	# OF OPENINGS	WEIGHT	VOLUME	LIST PRICE	DESCRIPTION
 Model Shown DM-3612-S-SL-36	DM-3610-S-SL-24	Single Face Starter	25 1/4"	10 1/8"	36"	9 1/2"	1	2			\$ 1,200	End, Mid, Top and Base Panels to be constructed from 1" thick 11-ply solid core, veneered 2 sides. Vertical, top and bottom edges banded with 1/4" external hardwood edging, edges to be eased. Front Edge: 3/4" thick x 2 1/2" high fascia - tongue and grooved to top.
	DM-3610-A-SL-24	Single Face Adder	24 1/4"	10 1/8"	36"	9 1/2"	1	2			\$ 900	
	DM-3612-S-SL-24	Single Face Starter	25 1/4"	12 1/8"	36"	11 1/2"	1	2			\$ 1,250	
	DM-3612-A-SL-24	Single Face Adder	24 1/4"	12 1/8"	36"	11 1/2"	1	2			\$ 925	
 Model Shown DM-3612-A-SL-36	DM-3610-S-SL-30	Single Face Starter	31 1/4"	10 1/8"	36"	9 1/2"	1	2			\$ 1,200	
	DM-3610-A-SL-30	Single Face Adder	30 1/4"	10 1/8"	36"	9 1/2"	1	2			\$ 900	
	DM-3612-S-SL-30	Single Face Starter	31 1/4"	12 1/8"	36"	11 1/2"	1	2			\$ 1,250	
	DM-3612-A-SL-30	Single Face Adder	30 1/4"	12 1/8"	36"	11 1/2"	1	2			\$ 925	
 Model Shown DM-3612-A-SL-36	DM-3610-S-SL-36	Single Face Starter	37 1/4"	10 1/8"	36"	9 1/2"	1	2	50.6 Lbs.	4 Cu Ft	\$ 1,050	
	DM-3610-A-SL-36	Single Face Adder	36 1/4"	10 1/8"	36"	9 1/2"	1	2	46 Lbs.	4 Cu Ft	\$ 744	
	DM-3612-S-SL-36	Single Face Starter	37 1/4"	12 1/8"	36"	11 1/2"	1	2	50.6 Lbs.	5 Cu Ft	\$ 1,094	
	DM-3612-A-SL-36	Single Face Adder	36 1/4"	12 1/8"	36"	11 1/2"	1	2	47.2 Lbs.	5 Cu Ft	\$ 775	
 Model Shown DM-4212-S-SL-36	DM-4210-S-SL-24	Single Face Starter	25 1/4"	10 1/8"	42"	9 1/2"	2	3			\$ 1,506	
	DM-4210-A-SL-24	Single Face Adder	24 1/4"	10 1/8"	42"	9 1/2"	2	3			\$ 1,206	
	DM-4212-S-SL-24	Single Face Starter	25 1/4"	12 1/8"	42"	11 1/2"	2	3			\$ 1,550	
	DM-4212-A-SL-24	Single Face Adder	24 1/4"	12 1/8"	42"	11 1/2"	2	3			\$ 1,238	
 Model Shown DM-4212-A-SL-36	DM-4210-S-SL-30	Single Face Starter	31 1/4"	10 1/8"	42"	9 1/2"	2	3			\$ 1,506	
	DM-4210-A-SL-30	Single Face Adder	30 1/4"	10 1/8"	42"	9 1/2"	2	3			\$ 1,206	
	DM-4212-S-SL-30	Single Face Starter	31 1/4"	12 1/8"	42"	11 1/2"	2	3			\$ 1,550	
	DM-4212-A-SL-30	Single Face Adder	30 1/4"	12 1/8"	42"	11 1/2"	2	3			\$ 1,238	
 Model Shown DM-4212-A-SL-36	DM-4210-S-SL-36	Single Face Starter	37 1/4"	10 1/8"	42"	9 1/2"	2	3	55 Lbs.	5 Cu Ft	\$ 1,356	
	DM-4210-A-SL-36	Single Face Adder	36 1/4"	10 1/8"	42"	9 1/2"	2	3	52 Lbs.	5 Cu Ft	\$ 1,025	
	DM-4212-S-SL-36	Single Face Starter	37 1/4"	12 1/8"	42"	11 1/2"	2	3	60 Lbs.	5 Cu Ft	\$ 1,400	
	DM-4212-A-SL-36	Single Face Adder	36 1/4"	12 1/8"	42"	11 1/2"	2	3	53 Lbs.	5 Cu Ft	\$ 1,081	

SHELVING

MODEL NUMBER	PRODUCT	WIDTH	DEPTH	HEIGHT	SHELF DEPTH	# OF SHELVES	# OF OPENINGS	WEIGHT	VOLUME	LIST PRICE	DESCRIPTION	
 <p>Model Shown DM-4212-S-SL-36</p>	DM-4810-S-SL-24	Single Face Starter	25 1/4"	10 1/8"	48"	9 1/2"	2	3		\$ 1,531	End, Mid, Top and Base Panels to be constructed from 1" thick 11-ply solid core, veneered 2 sides. Vertical, top and bottom edges banded with 1/4" external hardwood edging, edges to be eased. Front Edge: 3/4" thick x 2 1/2" high fascia - tongue and grooved to top.	
	DM-4810-A-SL-24	Single Face Adder	24 1/4"	10 1/8"	48"	9 1/2"	2	3		\$ 1,213		
	DM-4812-S-SL-24	Single Face Starter	25 1/4"	12 1/8"	48"	11 1/2"	2	3		\$ 1,563		
	DM-4812-A-SL-24	Single Face Adder	24 1/4"	12 1/8"	48"	11 1/2"	2	3		\$ 1,238		
	DM-4810-S-SL-30	Single Face Starter	31 1/4"	10 1/8"	48"	9 1/2"	2	3		\$ 1,531		
	DM-4810-A-SL-30	Single Face Adder	30 1/4"	10 1/8"	48"	9 1/2"	2	3		\$ 1,213		
	DM-4812-S-SL-30	Single Face Starter	31 1/4"	12 1/8"	48"	11 1/2"	2	3		\$ 1,563		
	DM-4812-A-SL-30	Single Face Adder	30 1/4"	12 1/8"	48"	11 1/2"	2	3		\$ 1,238		
 <p>Model Shown DM-4212-A-SL-36</p>	DM-4810-S-SL-36	Single Face Starter	37 1/4"	10 1/8"	48"	9 1/2"	2	3	74.8 Lbs.	5 Cu Ft		\$ 1,375
	DM-4810-A-SL-36	Single Face Adder	36 1/4"	10 1/8"	48"	9 1/2"	2	3	65.5 Lbs.	5 Cu Ft		\$ 1,056
	DM-4812-S-SL-36	Single Face Starter	37 1/4"	12 1/8"	48"	11 1/2"	2	3	82.8 Lbs.	6 Cu Ft		\$ 1,413
	DM-4812-A-SL-36	Single Face Adder	36 1/4"	12 1/8"	48"	11 1/2"	2	3	71.3 Lbs.	6 Cu Ft		\$ 1,081
 <p>Model Shown DM-6012-S-SL-36</p>	DM-6010-S-SL-24	Single Face Starter	25 1/4"	10 1/8"	60"	9 1/2"	3	4		\$ 1,681		
	DM-6010-A-SL-24	Single Face Adder	24 1/4"	10 1/8"	60"	9 1/2"	3	4		\$ 1,375		
	DM-6012-S-SL-24	Single Face Starter	25 1/4"	12 1/8"	60"	11 1/2"	3	4		\$ 1,719		
	DM-6012-A-SL-24	Single Face Adder	24 1/4"	12 1/8"	60"	11 1/2"	3	4		\$ 1,406		
	DM-6010-S-SL-30	Single Face Starter	31 1/4"	10 1/8"	60"	9 1/2"	3	4		\$ 1,681		
	DM-6010-A-SL-30	Single Face Adder	30 1/4"	10 1/8"	60"	9 1/2"	3	4		\$ 1,375		
	DM-6012-S-SL-30	Single Face Starter	31 1/4"	12 1/8"	60"	11 1/2"	3	4		\$ 1,719		
	DM-6012-A-SL-30	Single Face Adder	30 1/4"	12 1/8"	60"	11 1/2"	3	4		\$ 1,406		
	DM-6010-S-SL-36	Single Face Starter	37 1/4"	10 1/8"	60"	9 1/2"	3	4	100 Lbs.	6 Cu Ft		\$ 1,525
	DM-6010-A-SL-36	Single Face Adder	36 1/4"	10 1/8"	60"	9 1/2"	3	4	86.3 Lbs.	6 Cu Ft		\$ 1,219
	DM-6012-S-SL-36	Single Face Starter	37 1/4"	12 1/8"	60"	11 1/2"	3	4	116 Lbs.	8 Cu Ft		\$ 1,563
	DM-6012-A-SL-36	Single Face Adder	36 1/4"	12 1/8"	60"	11 1/2"	3	4	95.5 Lbs.	7 Cu Ft		\$ 1,250

Model Shown
DM-6012-A-SL-36

SHELVING

MODEL NUMBER	PRODUCT	WIDTH	DEPTH	HEIGHT	SHELF DEPTH	# OF SHELVES	# OF OPENINGS	WEIGHT	VOLUME	LIST PRICE	DESCRIPTION
DM-7210-S-SL-24	Single Face Starter	25 1/4"	10 1/8"	72"	9 1/2"	4	5			\$ 1,881	End, Mid, Top and Base Panels to be constructed from 1" thick 11-ply solid core, veneered 2 sides. Vertical, top and bottom edges banded with 1/4" external hardwood edging, edges to be eased. Front Edge: 3/4" thick x 2 1/2" high fascia - tongue and grooved to top.
DM-7210-A-SL-24	Single Face Adder	24 1/4"	10 1/8"	72"	9 1/2"	4	5			\$ 1,575	
DM-7212-S-SL-24	Single Face Starter	25 1/4"	12 1/8"	72"	11 1/2"	4	5			\$ 1,931	
DM-7212-A-SL-24	Single Face Adder	24 1/4"	12 1/8"	72"	11 1/2"	4	5			\$ 1,619	
DM-7210-S-SL-30	Single Face Starter	31 1/4"	10 1/8"	72"	9 1/2"	4	5			\$ 1,881	
DM-7210-A-SL-30	Single Face Adder	30 1/4"	10 1/8"	72"	9 1/2"	4	5			\$ 1,575	
DM-7212-S-SL-30	Single Face Starter	31 1/4"	12 1/8"	72"	11 1/2"	4	5			\$ 1,931	
DM-7212-A-SL-30	Single Face Adder	30 1/4"	12 1/8"	72"	11 1/2"	4	5			\$ 1,619	
DM-7210-S-SL-36	Single Face Starter	37 1/4"	10 1/8"	72"	9 1/2"	4	5	115 Lbs.	7 Cu Ft	\$ 1,725	
DM-7210-A-SL-36	Single Face Adder	36 1/4"	10 1/8"	72"	9 1/2"	4	5	96.6 Lbs.	7 Cu Ft	\$ 1,419	
DM-7212-S-SL-36	Single Face Starter	37 1/4"	12 1/8"	72"	11 1/2"	4	5	131 Lbs.	8 Cu Ft	\$ 1,781	
DM-7212-A-SL-36	Single Face Adder	36 1/4"	12 1/8"	72"	11 1/2"	4	5	109 Lbs.	8 Cu Ft	\$ 1,469	
DM-8210-S-SL-24	Single Face Starter	25 1/4"	10 1/8"	82"	9 1/2"	5	6			\$ 2,081	
DM-8210-A-SL-24	Single Face Adder	24 1/4"	10 1/8"	82"	9 1/2"	5	6			\$ 1,781	
DM-8212-S-SL-24	Single Face Starter	25 1/4"	12 1/8"	82"	11 1/2"	5	6			\$ 2,144	
DM-8212-A-SL-24	Single Face Adder	24 1/4"	12 1/8"	82"	11 1/2"	5	6			\$ 1,825	
DM-8210-S-SL-30	Single Face Starter	31 1/4"	10 1/8"	82"	9 1/2"	5	6			\$ 2,081	
DM-8210-A-SL-30	Single Face Adder	30 1/4"	10 1/8"	82"	9 1/2"	5	6			\$ 1,781	
DM-8212-S-SL-30	Single Face Starter	31 1/4"	12 1/8"	82"	11 1/2"	5	6			\$ 2,144	
DM-8212-A-SL-30	Single Face Adder	30 1/4"	12 1/8"	82"	11 1/2"	5	6			\$ 1,825	
DM-8210-S-SL-36	Single Face Starter	37 1/4"	10 1/8"	82"	9 1/2"	5	6	129 Lbs.	8 Cu Ft	\$ 1,931	
DM-8210-A-SL-36	Single Face Adder	36 1/4"	10 1/8"	82"	9 1/2"	5	6	107 Lbs.	7 Cu Ft	\$ 1,631	
DM-8212-S-SL-36	Single Face Starter	37 1/4"	12 1/8"	82"	11 1/2"	5	6	145 Lbs.	9 Cu Ft	\$ 1,988	
DM-8212-A-SL-36	Single Face Adder	36 1/4"	12 1/8"	82"	11 1/2"	5	6	122 Lbs.	8 Cu Ft	\$ 1,675	



Model Shown
DM-7212-S-SL-36



Model Shown
DM-7212-A-SL-36



Model Shown
DM-8212-S-SL-36



Model Shown
DM-8212-A-SL-36

SHELVING

MODEL NUMBER	PRODUCT	WIDTH	DEPTH	HEIGHT	SHELF DEPTH	# OF SHELVES	# OF OPENINGS	WEIGHT	VOLUME	LIST PRICE	DESCRIPTION
DM-9610-S-SL-24	Single Face Starter	25 1/4"	10 1/8"	96"	9 1/2"	6	7			\$ 2,288	End, Mid, Top and Base Panels to be constructed from 1" thick 11-ply solid core, veneered 2 sides. Vertical, top and bottom edges banded with 1/4" external hardwood edging, edges to be eased. Front Edge: 3/4" thick x 2 1/2" high fascia - tongue and grooved to top.
DM-9610-A-SL-24	Single Face Adder	24 1/4"	10 1/8"	96"	9 1/2"	6	7			\$ 1,981	
DM-9612-S-SL-24	Single Face Starter	25 1/4"	12 1/8"	96"	11 1/2"	6	7			\$ 2,356	
DM-9612-A-SL-24	Single Face Adder	24 1/4"	12 1/8"	96"	11 1/2"	6	7			\$ 2,056	
DM-9610-S-SL-30	Single Face Starter	31 1/4"	10 1/8"	96"	9 1/2"	6	7			\$ 2,288	
DM-9610-A-SL-30	Single Face Adder	30 1/4"	10 1/8"	96"	9 1/2"	6	7			\$ 1,981	
DM-9612-S-SL-30	Single Face Starter	31 1/4"	12 1/8"	96"	11 1/2"	6	7			\$ 2,356	
DM-9612-A-SL-30	Single Face Adder	30 1/4"	12 1/8"	96"	11 1/2"	6	7			\$ 2,069	
DM-9610-S-SL-36	Single Face Starter	37 1/4"	10 1/8"	96"	9 1/2"	6	7	156 Lbs.	9 Cu Ft	\$ 2,138	
DM-9610-A-SL-36	Single Face Adder	36 1/4"	10 1/8"	96"	9 1/2"	6	7	128 Lbs.	8 Cu Ft	\$ 1,825	
DM-9612-S-SL-36	Single Face Starter	37 1/4"	12 1/8"	96"	11 1/2"	6	7	177 Lbs.	10 Cu Ft	\$ 2,200	
DM-9612-A-SL-36	Single Face Adder	36 1/4"	12 1/8"	96"	11 1/2"	6	7	145 Lbs.	9 Cu Ft	\$ 1,906	



Model Shown
DM-6012-S-SL-36



Model Shown
DM-6012-A-SL-36

SHELVING

MODEL NUMBER	PRODUCT	WIDTH	DEPTH	HEIGHT	SHELF DEPTH	# OF SHELVES	# OF OPENINGS	WEIGHT	VOLUME	LIST PRICE	DESCRIPTION
--------------	---------	-------	-------	--------	-------------	--------------	---------------	--------	--------	------------	-------------



Model Shown
DM-3624-S-SL-36-SB

DM-3620-S-SL-24-SB	Double Face Starter	25 1/4"	19 1/2"	36"	9 1/2"	2	4			\$ 2,175	End, Mid, Top and Base Panels to be constructed from 1" thick 11-ply solid core, veneered 2 sides. Vertical, top and bottom edges banded with 1/4" external hardwood edging, edges to be eased. Front Edge: 3/4" thick x 2 1/2" high fascia - tongue and grooved to top.
DM-3620-A-SL-24-SB	Double Face Adder	24 1/4"	19 1/2"	36"	9 1/2"	2	4			\$ 1,650	
DM-3624-S-SL-24-SB	Double Face Starter	25 1/4"	23 1/2"	36"	11 1/2"	2	4			\$ 2,206	
DM-3624-A-SL-24-SB	Double Face Adder	24 1/4"	23 1/2"	36"	11 1/2"	2	4			\$ 1,663	



Model Shown
DM-3624-A-SL-36-SB

DM-3620-S-SL-30-SB	Double Face Starter	31 1/4"	19 1/2"	36"	9 1/2"	2	4			\$ 2,175
DM-3620-A-SL-30-SB	Double Face Adder	30 1/4"	19 1/2"	36"	9 1/2"	2	4			\$ 1,650
DM-3624-S-SL-30-SB	Double Face Starter	31 1/4"	23 1/2"	36"	11 1/2"	2	4			\$ 2,206
DM-3624-A-SL-30-SB	Double Face Adder	30 1/4"	23 1/2"	36"	11 1/2"	2	4			\$ 1,663
DM-3620-S-SL-36-SB	Double Face Starter	37 1/4"	19 1/2"	36"	9 1/2"	2	4	88.6 Lbs.	7 Cu Ft	\$ 1,944
DM-3620-A-SL-36-SB	Double Face Adder	36 1/4"	19 1/2"	36"	9 1/2"	2	4	73.6 Lbs.	6 Cu Ft	\$ 1,413
DM-3624-S-SL-36-SB	Double Face Starter	37 1/4"	23 1/2"	36"	11 1/2"	2	4	110 Lbs.	10 Cu Ft	\$ 1,981
DM-3624-A-SL-36-SB	Double Face Adder	36 1/4"	23 1/2"	36"	11 1/2"	2	4	88.6 Lbs.	9 Cu Ft	\$ 1,431



Model Shown
DM-4224-S-SL-36-SB







DM-4220-S-SL-24-SB	Double Face Starter	25 1/4"	19 1/2"	42"	9 1/2"	4	6			\$ 2,544
DM-4220-A-SL-24-SB	Double Face Adder	24 1/4"	19 1/2"	42"	9 1/2"	4	6			\$ 2,006
DM-4224-S-SL-24-SB	Double Face Starter	25 1/4"	23 1/2"	42"	11 1/2"	4	6			\$ 2,581
DM-4224-A-SL-24-SB	Double Face Adder	24 1/4"	23 1/2"	42"	11 1/2"	4	6			\$ 2,019



Model Shown
DM-4224-A-SL-36-SB

DM-4220-S-SL-30-SB	Double Face Starter	31 1/4"	19 1/2"	42"	9 1/2"	4	6			\$ 2,544
DM-4220-A-SL-30-SB	Double Face Adder	30 1/4"	19 1/2"	42"	9 1/2"	4	6			\$ 2,006
DM-4224-S-SL-30-SB	Double Face Starter	31 1/4"	23 1/2"	42"	11 1/2"	4	6			\$ 2,581
DM-4224-A-SL-30-SB	Double Face Adder	30 1/4"	23 1/2"	42"	11 1/2"	4	6			\$ 2,019
DM-4220-S-SL-36-SB	Double Face Starter	37 1/4"	19 1/2"	42"	9 1/2"	4	6	94 Lbs.	7 Cu Ft	\$ 2,313
DM-4220-A-SL-36-SB	Double Face Adder	36 1/4"	19 1/2"	42"	9 1/2"	4	6	78 Lbs.	7 Cu Ft	\$ 1,769
DM-4224-S-SL-36-SB	Double Face Starter	37 1/4"	23 1/2"	42"	11 1/2"	4	6	115 Lbs.	10 Cu Ft	\$ 2,350
DM-4224-A-SL-36-SB	Double Face Adder	36 1/4"	23 1/2"	42"	11 1/2"	4	6	113 Lbs.	10 Cu Ft	\$ 1,794

SHELVING

MODEL NUMBER	PRODUCT	WIDTH	DEPTH	HEIGHT	SHELF DEPTH	# OF SHELVES	# OF OPENINGS	WEIGHT	VOLUME	LIST PRICE	DESCRIPTION
 Model Shown DM-4224-S-SL-36-SB	DM-4820-S-SL-24-SB	Double Face Starter	25 1/4"	19 1/2"	48"	9 1/2"	4			\$ 2,613	End, Mid, Top and Base Panels to be constructed from 1" thick 11-ply solid core, veneered 2 sides. Vertical, top and bottom edges banded with 1/4" external hardwood edging, edges to be eased. Front Edge: 3/4" thick x 2 1/2" high fascia - tongue and grooved to top.
	DM-4820-A-SL-24-SB	Double Face Adder	24 1/4"	19 1/2"	48"	9 1/2"	4			\$ 2,225	
	DM-4824-S-SL-24-SB	Double Face Starter	25 1/4"	23 1/2"	48"	11 1/2"	4			\$ 2,806	
	DM-4824-A-SL-24-SB	Double Face Adder	24 1/4"	23 1/2"	48"	11 1/2"	4			\$ 2,256	
 Model Shown DM-4224-A-SL-36-SB	DM-4820-S-SL-30-SB	Double Face Starter	31 1/4"	19 1/2"	48"	9 1/2"	4			\$ 2,613	
	DM-4820-A-SL-30-SB	Double Face Adder	30 1/4"	19 1/2"	48"	9 1/2"	4			\$ 2,225	
	DM-4824-S-SL-30-SB	Double Face Starter	31 1/4"	23 1/2"	48"	11 1/2"	4			\$ 2,806	
	DM-4824-A-SL-30-SB	Double Face Adder	30 1/4"	23 1/2"	48"	11 1/2"	4			\$ 2,256	
 Model Shown DM-4224-A-SL-36-SB	DM-4820-S-SL-36-SB	Double Face Starter	37 1/4"	19 1/2"	48"	9 1/2"	4			\$ 2,525	
	DM-4820-A-SL-36-SB	Double Face Adder	36 1/4"	19 1/2"	48"	9 1/2"	4	132 Lbs.	9 Cu Ft	\$ 2,000	
	DM-4824-S-SL-36-SB	Double Face Starter	37 1/4"	23 1/2"	48"	11 1/2"	4	109 Lbs.	8 Cu Ft	\$ 2,569	
	DM-4824-A-SL-36-SB	Double Face Adder	36 1/4"	23 1/2"	48"	11 1/2"	4	155 Lbs.	11 Cu Ft	\$ 2,025	
 Model Shown DM-6024-S-SL-36-SB	DM-6020-S-SL-24-SB	Double Face Starter	25 1/4"	19 1/2"	60"	9 1/2"	6			\$ 3,094	
	DM-6020-A-SL-24-SB	Double Face Adder	24 1/4"	19 1/2"	60"	9 1/2"	6			\$ 2,544	
	DM-6024-S-SL-24-SB	Double Face Starter	25 1/4"	23 1/2"	60"	11 1/2"	6			\$ 3,138	
	DM-6024-A-SL-24-SB	Double Face Adder	24 1/4"	23 1/2"	60"	11 1/2"	6			\$ 2,600	
 Model Shown DM-6024-S-SL-36-SB	DM-6020-S-SL-30-SB	Double Face Starter	31 1/4"	19 1/2"	60"	9 1/2"	6			\$ 3,094	
	DM-6020-A-SL-30-SB	Double Face Adder	30 1/4"	19 1/2"	60"	9 1/2"	6			\$ 2,544	
	DM-6024-S-SL-30-SB	Double Face Starter	31 1/4"	23 1/2"	60"	11 1/2"	6			\$ 3,138	
	DM-6024-A-SL-30-SB	Double Face Adder	30 1/4"	23 1/2"	60"	11 1/2"	6			\$ 2,600	
 Model Shown DM-6024-A-SL-36-SB	DM-6020-S-SL-36-SB	Double Face Starter	37 1/4"	19 1/2"	60"	9 1/2"	6			\$ 2,863	
	DM-6020-A-SL-36-SB	Double Face Adder	36 1/4"	19 1/2"	60"	9 1/2"	6	176 Lbs.	11 Cu Ft	\$ 2,313	
	DM-6024-S-SL-36-SB	Double Face Starter	37 1/4"	23 1/2"	60"	11 1/2"	6	145 Lbs.	10 Cu Ft	\$ 2,906	
	DM-6024-A-SL-36-SB	Double Face Adder	36 1/4"	23 1/2"	60"	11 1/2"	6	200 Lbs.	12 Cu Ft	\$ 2,363	

MODEL NUMBER	PRODUCT	WIDTH	DEPTH	HEIGHT	SHELF DEPTH	# OF SHELVES	# OF OPENINGS	WEIGHT	VOLUME	LIST PRICE	DESCRIPTION
DM-7220-S-SL-24-SB	Double Face Starter	25 1/4"	19 1/2"	72"	9 1/2"	8	10			\$ 3,506	End, Mid, Top and Base Panels to be constructed from 1" thick 11-ply solid core, veneered 2 sides. Vertical, top and bottom edges banded with 1/4" external hardwood edging, edges to be eased. Front Edge: 3/4" thick x 2 1/2" high fascia - tongue and grooved to top.
DM-7220-A-SL-24-SB	Double Face Adder	24 1/4"	19 1/2"	72"	9 1/2"	8	10			\$ 2,956	
DM-7224-S-SL-24-SB	Double Face Starter	25 1/4"	23 1/2"	72"	11 1/2"	8	10			\$ 3,556	
DM-7224-A-SL-24-SB	Double Face Adder	24 1/4"	23 1/2"	72"	11 1/2"	8	10			\$ 3,006	
DM-7220-S-SL-30-SB	Double Face Starter	31 1/4"	19 1/2"	72"	9 1/2"	8	10			\$ 3,506	
DM-7220-A-SL-30-SB	Double Face Adder	30 1/4"	19 1/2"	72"	9 1/2"	8	10			\$ 2,956	
DM-7224-S-SL-30-SB	Double Face Starter	31 1/4"	23 1/2"	72"	11 1/2"	8	10			\$ 3,556	
DM-7224-A-SL-30-SB	Double Face Adder	30 1/4"	23 1/2"	72"	11 1/2"	8	10			\$ 3,006	
DM-7220-S-SL-36-SB	Double Face Starter	37 1/4"	19 1/2"	72"	9 1/2"	8	10	200 Lbs.	12 Cu Ft	\$ 3,275	
DM-7220-A-SL-36-SB	Double Face Adder	36 1/4"	19 1/2"	72"	9 1/2"	8	10	164 Lbs.	11 Cu Ft	\$ 2,719	
DM-7224-S-SL-36-SB	Double Face Starter	37 1/4"	23 1/2"	72"	11 1/2"	8	10	229 Lbs.	13 Cu Ft	\$ 3,325	
DM-7224-A-SL-36-SB	Double Face Adder	36 1/4"	23 1/2"	72"	11 1/2"	8	10	186 Lbs.	12 Cu Ft	\$ 2,775	
DM-8220-S-SL-24-SB	Double Face Starter	25 1/4"	19 1/2"	82"	9 1/2"	10	12			\$ 3,775	
DM-8220-A-SL-24-SB	Double Face Adder	24 1/4"	19 1/2"	82"	9 1/2"	10	12			\$ 3,231	
DM-8224-S-SL-24-SB	Double Face Starter	25 1/4"	23 1/2"	82"	11 1/2"	10	12			\$ 3,838	
DM-8224-A-SL-24-SB	Double Face Adder	24 1/4"	23 1/2"	82"	11 1/2"	10	12			\$ 3,300	
DM-8220-S-SL-30-SB	Double Face Starter	31 1/4"	19 1/2"	82"	9 1/2"	10	12			\$ 3,775	
DM-8220-A-SL-30-SB	Double Face Adder	30 1/4"	19 1/2"	82"	9 1/2"	10	12			\$ 3,231	
DM-8224-S-SL-30-SB	Double Face Starter	31 1/4"	23 1/2"	82"	11 1/2"	10	12			\$ 3,838	
DM-8224-A-SL-30-SB	Double Face Adder	30 1/4"	23 1/2"	82"	11 1/2"	10	12			\$ 3,300	
DM-8220-S-SL-36-SB	Double Face Starter	37 1/4"	19 1/2"	82"	9 1/2"	10	12	224 Lbs.	12 Cu Ft	\$ 3,544	
DM-8220-A-SL-36-SB	Double Face Adder	36 1/4"	19 1/2"	82"	9 1/2"	10	12	184 Lbs.	11 Cu Ft	\$ 3,000	
DM-8224-S-SL-36-SB	Double Face Starter	37 1/4"	23 1/2"	82"	11 1/2"	10	12	256 Lbs.	14 Cu Ft	\$ 3,613	
DM-8224-A-SL-36-SB	Double Face Adder	36 1/4"	23 1/2"	82"	11 1/2"	10	12	207 Lbs.	12 Cu Ft	\$ 3,069	



Model Shown
DM-7224-S-SL-36-SB



Model Shown
DM-7224-A-SL-36-SB



Model Shown
DM-8224-S-SL-36-SB



Model Shown
DM-8224-A-SL-36-SB

SHELVING

MODEL NUMBER	PRODUCT	WIDTH	DEPTH	HEIGHT	SHELF DEPTH	# OF SHELVES	# OF OPENINGS	WEIGHT	VOLUME	LIST PRICE	DESCRIPTION
DM-9620-S-SL-24-SB	Double Face Starter	25 1/4"	19 1/2"	96"	9 1/2"	12	14			\$ 4,056	End, Mid, Top and Base Panels to be constructed from 1" thick 11-ply solid core, veneered 2 sides. Vertical, top and bottom edges banded with 1/4" external hardwood edging, edges to be eased. Front Edge: 3/4" thick x 2 1/2" high fascia - tongue and grooved to top.
DM-9620-A-SL-24-SB	Double Face Adder	24 1/4"	19 1/2"	96"	9 1/2"	12	14			\$ 3,500	
DM-9624-S-SL-24-SB	Double Face Starter	25 1/4"	23 1/2"	96"	11 1/2"	12	14			\$ 4,125	
DM-9624-A-SL-24-SB	Double Face Adder	24 1/4"	23 1/2"	96"	11 1/2"	12	14			\$ 3,588	
DM-9620-S-SL-30-SB	Double Face Starter	31 1/4"	19 1/2"	96"	9 1/2"	12	14			\$ 4,056	
DM-9620-A-SL-30-SB	Double Face Adder	30 1/4"	19 1/2"	96"	9 1/2"	12	14			\$ 3,500	
DM-9624-S-SL-30-SB	Double Face Starter	31 1/4"	23 1/2"	96"	11 1/2"	12	14			\$ 4,125	
DM-9624-A-SL-30-SB	Double Face Adder	30 1/4"	23 1/2"	96"	11 1/2"	12	14			\$ 3,588	
DM-9620-S-SL-36-SB	Double Face Starter	37 1/4"	19 1/2"	96"	9 1/2"	12	14	276 Lbs.	13 Cu Ft	\$ 3,819	
DM-9620-A-SL-36-SB	Double Face Adder	36 1/4"	19 1/2"	96"	9 1/2"	12	14	220 Lbs.	12 Cu Ft	\$ 3,275	
DM-9624-S-SL-36-SB	Double Face Starter	37 1/4"	23 1/2"	96"	11 1/2"	12	14	315 Lbs.	15 Cu Ft	\$ 3,894	
DM-9624-A-SL-36-SB	Double Face Adder	36 1/4"	23 1/2"	96"	11 1/2"	12	14	247 Lbs.	13 Cu Ft	\$ 3,350	





Model Shown
DM-6024-S-SL-36-SB



Model Shown
DM-6024-A-SL-36-SB



SHELVING

MODEL NUMBER	PRODUCT	WIDTH	DEPTH	HEIGHT	SHELF DEPTH	# OF SHELVES	# OF OPENINGS	WEIGHT	VOLUME	LIST PRICE	DESCRIPTION
--------------	---------	-------	-------	--------	-------------	--------------	---------------	--------	--------	------------	-------------

	DM-3610-S-SL-24-IPT	Single Face Starter	25 1/4"	10 1/8"	36"	9 1/2"	1			\$ 1,281	End, Mid, Top and Base Panels to be constructed from 1" thick 11-ply solid core, veneered 2 sides. Vertical, top and bottom edges banded with 1/4" external hardwood edging, edges to be eased. Front Edge: 3/4" thick x 2 1/2" high fascia - tongue and grooved to top.
	DM-3610-A-SL-24-IPT	Single Face Adder	24 1/4"	10 1/8"	36"	9 1/2"	1			\$ 981	
	DM-3612-S-SL-24-IPT	Single Face Starter	25 1/4"	12 1/8"	36"	11 1/2"	1			\$ 1,331	
	DM-3612-A-SL-24-IPT	Single Face Adder	24 1/4"	12 1/8"	36"	11 1/2"	1			\$ 1,006	
	DM-3610-S-SL-30-IPT	Single Face Starter	31 1/4"	10 1/8"	36"	9 1/2"	1			\$ 1,281	
	DM-3610-A-SL-30-IPT	Single Face Adder	30 1/4"	10 1/8"	36"	9 1/2"	1			\$ 981	
	DM-3612-S-SL-30-IPT	Single Face Starter	31 1/4"	12 1/8"	36"	11 1/2"	1			\$ 1,331	
	DM-3612-A-SL-30-IPT	Single Face Adder	30 1/4"	12 1/8"	36"	11 1/2"	1			\$ 1,006	
	DM-3610-S-SL-36-IPT	Single Face Starter	37 1/4"	10 1/8"	36"	9 1/2"	1			\$ 1,131	
	DM-3610-A-SL-36-IPT	Single Face Adder	36 1/4"	10 1/8"	36"	9 1/2"	1			\$ 819	
	DM-3612-S-SL-36-IPT	Single Face Starter	37 1/4"	12 1/8"	36"	11 1/2"	1			\$ 1,175	
	DM-3612-A-SL-36-IPT	Single Face Adder	36 1/4"	12 1/8"	36"	11 1/2"	1	50.6 Lbs.	4 Cu Ft	\$ 856	

Model Shown
DM-3612-S-SL-36-IPT

Model Shown
DM-3612-A-SL-36-IPT

	DM-4210-S-SL-24-IPT	Single Face Starter	25 1/4"	10 1/8"	42"	9 1/2"	2			\$ 1,588
	DM-4210-A-SL-24-IPT	Single Face Adder	24 1/4"	10 1/8"	42"	9 1/2"	2			\$ 1,281
	DM-4212-S-SL-24-IPT	Single Face Starter	25 1/4"	12 1/8"	42"	11 1/2"	2			\$ 1,631
	DM-4212-A-SL-24-IPT	Single Face Adder	24 1/4"	12 1/8"	42"	11 1/2"	2			\$ 1,319
	DM-4210-S-SL-30-IPT	Single Face Starter	31 1/4"	10 1/8"	42"	9 1/2"	2			\$ 1,588
	DM-4210-A-SL-30-IPT	Single Face Adder	30 1/4"	10 1/8"	42"	9 1/2"	2			\$ 1,281
	DM-4212-S-SL-30-IPT	Single Face Starter	31 1/4"	12 1/8"	42"	11 1/2"	2			\$ 1,631
	DM-4212-A-SL-30-IPT	Single Face Adder	30 1/4"	12 1/8"	42"	11 1/2"	2			\$ 1,319
	DM-4210-S-SL-36-IPT	Single Face Starter	37 1/4"	10 1/8"	42"	9 1/2"	2			\$ 1,431
	DM-4210-A-SL-36-IPT	Single Face Adder	36 1/4"	10 1/8"	42"	9 1/2"	2			\$ 1,100
	DM-4212-S-SL-36-IPT	Single Face Starter	37 1/4"	12 1/8"	42"	11 1/2"	2			\$ 1,481
	DM-4212-A-SL-36-IPT	Single Face Adder	36 1/4"	12 1/8"	42"	11 1/2"	2	55 Lbs.	5 Cu Ft	\$ 1,163

Model Shown
DM-4212-S-SL-36-IPT

Model Shown
DM-4212-A-SL-36-IPT

SHELVING

MODEL NUMBER	PRODUCT	WIDTH	DEPTH	HEIGHT	SHELF DEPTH	# OF SHELVES	# OF OPENINGS	WEIGHT	VOLUME	LIST PRICE	DESCRIPTION
--------------	---------	-------	-------	--------	-------------	--------------	---------------	--------	--------	------------	-------------



Model Shown
DM-4212-S-SL-36-IPT

DM-4810-S-SL-24-IPT	Single Face Starter	25 1/4"	10 1/8"	48"	9 1/2"	2	3			\$ 1,606	End, Mid, Top and Base Panels to be constructed from 1" thick 11-ply solid core, veneered 2 sides. Vertical, top and bottom edges banded with 1/4" external hardwood edging, edges to be eased. Front Edge: 3/4" thick x 2 1/2" high fascia - tongue and grooved to top.
DM-4810-A-SL-24-IPT	Single Face Adder	24 1/4"	10 1/8"	48"	9 1/2"	2	3			\$ 1,294	
DM-4812-S-SL-24-IPT	Single Face Starter	25 1/4"	12 1/8"	48"	11 1/2"	2	3			\$ 1,644	
DM-4812-A-SL-24-IPT	Single Face Adder	24 1/4"	12 1/8"	48"	11 1/2"	2	3			\$ 1,319	
DM-4810-S-SL-30-IPT	Single Face Starter	31 1/4"	10 1/8"	48"	9 1/2"	2	3			\$ 1,606	
DM-4810-A-SL-30-IPT	Single Face Adder	30 1/4"	10 1/8"	48"	9 1/2"	2	3			\$ 1,294	
DM-4812-S-SL-30-IPT	Single Face Starter	31 1/4"	12 1/8"	48"	11 1/2"	2	3			\$ 1,644	
DM-4812-A-SL-30-IPT	Single Face Adder	30 1/4"	12 1/8"	48"	11 1/2"	2	3			\$ 1,319	



Model Shown
DM-4212-A-SL-36-IPT

DM-4810-S-SL-36-IPT	Single Face Starter	37 1/4"	10 1/8"	48"	9 1/2"	2	3	74.8 Lbs.	5 Cu Ft	\$ 1,456
DM-4810-A-SL-36-IPT	Single Face Adder	36 1/4"	10 1/8"	48"	9 1/2"	2	3	65.5 Lbs.	5 Cu Ft	\$ 1,119
DM-4812-S-SL-36-IPT	Single Face Starter	37 1/4"	12 1/8"	48"	11 1/2"	2	3	82.8 Lbs.	6 Cu Ft	\$ 1,494
DM-4812-A-SL-36-IPT	Single Face Adder	36 1/4"	12 1/8"	48"	11 1/2"	2	3	71.3 Lbs.	6 Cu Ft	\$ 1,163



Model Shown
DM-6012-S-SL-36-IPT





DM-6010-S-SL-24-IPT	Single Face Starter	25 1/4"	10 1/8"	60"	9 1/2"	3	4			\$ 1,756
DM-6010-A-SL-24-IPT	Single Face Adder	24 1/4"	10 1/8"	60"	9 1/2"	3	4			\$ 1,456
DM-6012-S-SL-24-IPT	Single Face Starter	25 1/4"	12 1/8"	60"	11 1/2"	3	4			\$ 1,800
DM-6012-A-SL-24-IPT	Single Face Adder	24 1/4"	12 1/8"	60"	11 1/2"	3	4			\$ 1,488
DM-6010-S-SL-30-IPT	Single Face Starter	31 1/4"	10 1/8"	60"	9 1/2"	3	4			\$ 1,756
DM-6010-A-SL-30-IPT	Single Face Adder	30 1/4"	10 1/8"	60"	9 1/2"	3	4			\$ 1,456
DM-6012-S-SL-30-IPT	Single Face Starter	31 1/4"	12 1/8"	60"	11 1/2"	3	4			\$ 1,800
DM-6012-A-SL-30-IPT	Single Face Adder	30 1/4"	12 1/8"	60"	11 1/2"	3	4			\$ 1,488





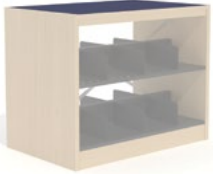
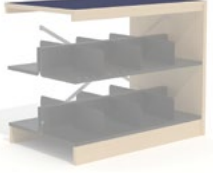



Model Shown
DM-6012-A-SL-36-IPT

DM-6010-S-SL-36-IPT	Single Face Starter	37 1/4"	10 1/8"	60"	9 1/2"	3	4	100 Lbs.	6 Cu Ft	\$ 1,606
DM-6010-A-SL-36-IPT	Single Face Adder	36 1/4"	10 1/8"	60"	9 1/2"	3	4	86.3 Lbs.	6 Cu Ft	\$ 1,294
DM-6012-S-SL-36-IPT	Single Face Starter	37 1/4"	12 1/8"	60"	11 1/2"	3	4	116 Lbs.	8 Cu Ft	\$ 1,644
DM-6012-A-SL-36-IPT	Single Face Adder	36 1/4"	12 1/8"	60"	11 1/2"	3	4	95.5 Lbs.	7 Cu Ft	\$ 1,331



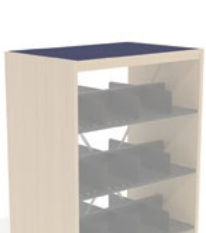



SHELVING

	MODEL NUMBER	PRODUCT	WIDTH	DEPTH	HEIGHT	SHELF DEPTH	# OF SHELVES	# OF OPENINGS	WEIGHT	VOLUME	LIST PRICE	DESCRIPTION
	DM-3620-S-SL-24-SB-IPT	Double Face Starter	25 1/4"	19 1/2"	36"	9 1/2"	2	4			\$ 2,331	End, Mid, Top and Base Panels to be constructed from 1" thick 11-ply solid core, veneered 2 sides. Vertical, top and bottom edges banded with 1/4" external hardwood edging, edges to be eased. Front Edge: 3/4" thick x 2 1/2" high fascia - tongue and grooved to top.
	DM-3620-A-SL-24-SB-IPT	Double Face Adder	24 1/4"	19 1/2"	36"	9 1/2"	2	4			\$ 1,806	
	DM-3624-S-SL-24-SB-IPT	Double Face Starter	25 1/4"	23 1/2"	36"	11 1/2"	2	4			\$ 2,363	
	DM-3624-A-SL-24-SB-IPT	Double Face Adder	24 1/4"	23 1/2"	36"	11 1/2"	2	4			\$ 1,819	
	DM-3620-S-SL-30-SB-IPT	Double Face Starter	31 1/4"	19 1/2"	36"	9 1/2"	2	4			\$ 2,331	
	DM-3620-A-SL-30-SB-IPT	Double Face Adder	30 1/4"	19 1/2"	36"	9 1/2"	2	4			\$ 1,806	
	DM-3624-S-SL-30-SB-IPT	Double Face Starter	31 1/4"	23 1/2"	36"	11 1/2"	2	4			\$ 2,363	
	DM-3624-A-SL-30-SB-IPT	Double Face Adder	30 1/4"	23 1/2"	36"	11 1/2"	2	4			\$ 1,819	
	DM-3620-S-SL-36-SB-IPT	Double Face Starter	37 1/4"	19 1/2"	36"	9 1/2"	2	4	88.6 Lbs.	7 Cu Ft	\$ 2,094	
	DM-3620-A-SL-36-SB-IPT	Double Face Adder	36 1/4"	19 1/2"	36"	9 1/2"	2	4	73.6 Lbs.	6 Cu Ft	\$ 1,569	
	DM-3624-S-SL-36-SB-IPT	Double Face Starter	37 1/4"	23 1/2"	36"	11 1/2"	2	4	110 Lbs.	10 Cu Ft	\$ 2,138	
	DM-3624-A-SL-36-SB-IPT	Double Face Adder	36 1/4"	23 1/2"	36"	11 1/2"	2	4	88.6 Lbs.	9 Cu Ft	\$ 1,588	
	DM-4220-S-SL-24-SB-IPT	Double Face Starter	25 1/4"	19 1/2"	42"	9 1/2"	4	6			\$ 2,700	
	DM-4220-A-SL-24-SB-IPT	Double Face Adder	24 1/4"	19 1/2"	42"	9 1/2"	4	6			\$ 2,163	
	DM-4224-S-SL-24-SB-IPT	Double Face Starter	25 1/4"	23 1/2"	42"	11 1/2"	4	6			\$ 2,744	
	DM-4224-A-SL-24-SB-IPT	Double Face Adder	24 1/4"	23 1/2"	42"	11 1/2"	4	6			\$ 2,175	
	DM-4220-S-SL-30-SB-IPT	Double Face Starter	31 1/4"	19 1/2"	42"	9 1/2"	4	6			\$ 2,700	
	DM-4220-A-SL-30-SB-IPT	Double Face Adder	30 1/4"	19 1/2"	42"	9 1/2"	4	6			\$ 2,163	
	DM-4224-S-SL-30-SB-IPT	Double Face Starter	31 1/4"	23 1/2"	42"	11 1/2"	4	6			\$ 2,744	
	DM-4224-A-SL-30-SB-IPT	Double Face Adder	30 1/4"	23 1/2"	42"	11 1/2"	4	6			\$ 2,175	
	DM-4220-S-SL-36-SB-IPT	Double Face Starter	37 1/4"	19 1/2"	42"	9 1/2"	4	6	94 Lbs.	7 Cu Ft	\$ 2,469	
	DM-4220-A-SL-36-SB-IPT	Double Face Adder	36 1/4"	19 1/2"	42"	9 1/2"	4	6	78 Lbs.	7 Cu Ft	\$ 1,931	
	DM-4224-S-SL-36-SB-IPT	Double Face Starter	37 1/4"	23 1/2"	42"	11 1/2"	4	6	115 Lbs.	10 Cu Ft	\$ 2,506	
	DM-4224-A-SL-36-SB-IPT	Double Face Adder	36 1/4"	23 1/2"	42"	11 1/2"	4	6	113 Lbs.	10 Cu Ft	\$ 1,944	





SHELVING

	MODEL NUMBER	PRODUCT	WIDTH	DEPTH	HEIGHT	SHELF DEPTH	# OF SHELVES	# OF OPENINGS	WEIGHT	VOLUME	LIST PRICE	DESCRIPTION
	DM-4820-S-SL-24-SB-IPT	Double Face Starter	25 1/4"	19 1/2"	48"	9 1/2"	4	6			\$ 2,769	End, Mid, Top and Base Panels to be constructed from 1" thick 11-ply solid core, veneered 2 sides. Vertical, top and bottom edges banded with 1/4" external hardwood edging, edges to be eased. Front Edge: 3/4" thick x 2 1/2" high fascia - tongue and grooved to top.
	DM-4820-A-SL-24-SB-IPT	Double Face Adder	24 1/4"	19 1/2"	48"	9 1/2"	4	6			\$ 2,381	
	DM-4824-S-SL-24-SB-IPT	Double Face Starter	25 1/4"	23 1/2"	48"	11 1/2"	4	6			\$ 2,963	
	DM-4824-A-SL-24-SB-IPT	Double Face Adder	24 1/4"	23 1/2"	48"	11 1/2"	4	6			\$ 2,406	
	DM-4820-S-SL-30-SB-IPT	Double Face Starter	31 1/4"	19 1/2"	48"	9 1/2"	4	6			\$ 2,769	
	DM-4820-A-SL-30-SB-IPT	Double Face Adder	30 1/4"	19 1/2"	48"	9 1/2"	4	6			\$ 2,381	
	DM-4824-S-SL-30-SB-IPT	Double Face Starter	31 1/4"	23 1/2"	48"	11 1/2"	4	6			\$ 2,963	
	DM-4824-A-SL-30-SB-IPT	Double Face Adder	30 1/4"	23 1/2"	48"	11 1/2"	4	6			\$ 2,406	
	DM-4820-S-SL-36-SB-IPT	Double Face Starter	37 1/4"	19 1/2"	48"	9 1/2"	4	6	132 Lbs.	9 Cu Ft	\$ 2,681	
	DM-4820-A-SL-36-SB-IPT	Double Face Adder	36 1/4"	19 1/2"	48"	9 1/2"	4	6	109 Lbs.	8 Cu Ft	\$ 2,156	
	DM-4824-S-SL-36-SB-IPT	Double Face Starter	37 1/4"	23 1/2"	48"	11 1/2"	4	6	155 Lbs.	11 Cu Ft	\$ 2,731	
	DM-4824-A-SL-36-SB-IPT	Double Face Adder	36 1/4"	23 1/2"	48"	11 1/2"	4	6	127 Lbs.	10 Cu Ft	\$ 2,181	
	DM-6020-S-SL-24-SB-IPT	Double Face Starter	25 1/4"	19 1/2"	60"	9 1/2"	6	8			\$ 3,250	
	DM-6020-A-SL-24-SB-IPT	Double Face Adder	24 1/4"	19 1/2"	60"	9 1/2"	6	8			\$ 2,700	
	DM-6024-S-SL-24-SB-IPT	Double Face Starter	25 1/4"	23 1/2"	60"	11 1/2"	6	8			\$ 3,294	
	DM-6024-A-SL-24-SB-IPT	Double Face Adder	24 1/4"	23 1/2"	60"	11 1/2"	6	8			\$ 2,756	
	DM-6020-S-SL-30-SB-IPT	Double Face Starter	31 1/4"	19 1/2"	60"	9 1/2"	6	8			\$ 3,250	
	DM-6020-A-SL-30-SB-IPT	Double Face Adder	30 1/4"	19 1/2"	60"	9 1/2"	6	8			\$ 2,700	
	DM-6024-S-SL-30-SB-IPT	Double Face Starter	31 1/4"	23 1/2"	60"	11 1/2"	6	8			\$ 3,294	
	DM-6024-A-SL-30-SB-IPT	Double Face Adder	30 1/4"	23 1/2"	60"	11 1/2"	6	8			\$ 2,756	
	DM-6020-S-SL-36-SB-IPT	Double Face Starter	37 1/4"	19 1/2"	60"	9 1/2"	6	8	176 Lbs.	11 Cu Ft	\$ 3,019	
	DM-6020-A-SL-36-SB-IPT	Double Face Adder	36 1/4"	19 1/2"	60"	9 1/2"	6	8	145 Lbs.	10 Cu Ft	\$ 2,469	
	DM-6024-S-SL-36-SB-IPT	Double Face Starter	37 1/4"	23 1/2"	60"	11 1/2"	6	8	200 Lbs.	12 Cu Ft	\$ 3,056	
	DM-6024-A-SL-36-SB-IPT	Double Face Adder	36 1/4"	23 1/2"	60"	11 1/2"	6	8	164 Lbs.	11 Cu Ft	\$ 2,519	

SHELVING

MODEL NUMBER	PRODUCT	WIDTH	DEPTH	HEIGHT	SHELF DEPTH	# OF SHELVES	# OF OPENINGS	WEIGHT	VOLUME	LIST PRICE	DESCRIPTION
 Model Shown M3612-S-SL-36-PB	DM-3610-S-SL-24-PB	Single Face Starter	25 1/4"	10 1/8"	36"	9 1/2"	1			\$ 1,294	End, Mid, Top and Base Panels to be constructed from 1" thick 11-ply solid core, veneered 2 sides. Vertical, top and bottom edges banded with 1/4" external hardwood edging, edges to be eased. Front Edge: 3/4" thick x 2 1/2" high fascia - tongue and grooved to top.
	DM-3610-A-SL-24-PB	Single Face Adder	24 1/4"	10 1/8"	36"	9 1/2"	1			\$ 981	
	DM-3612-S-SL-24-PB	Single Face Starter	25 1/4"	12 1/8"	36"	11 1/2"	1			\$ 1,338	
	DM-3612-A-SL-24-PB	Single Face Adder	24 1/4"	12 1/8"	36"	11 1/2"	1			\$ 1,019	
 Model Shown DM-3612-A-SL-36-PB	DM-3610-S-SL-30-PB	Single Face Starter	31 1/4"	10 1/8"	36"	9 1/2"	1			\$ 1,263	
	DM-3610-A-SL-30-PB	Single Face Adder	30 1/4"	10 1/8"	36"	9 1/2"	1			\$ 981	
	DM-3612-S-SL-30-PB	Single Face Starter	31 1/4"	12 1/8"	36"	11 1/2"	1			\$ 1,338	
	DM-3612-A-SL-30-PB	Single Face Adder	30 1/4"	12 1/8"	36"	11 1/2"	1			\$ 1,019	
 Model Shown DM-3612-A-SL-36-PB	DM-3610-S-SL-36-PB	Single Face Starter	37 1/4"	10 1/8"	36"	9 1/2"	1			\$ 1,131	
	DM-3610-A-SL-36-PB	Single Face Adder	36 1/4"	10 1/8"	36"	9 1/2"	1			\$ 838	
	DM-3612-S-SL-36-PB	Single Face Starter	37 1/4"	12 1/8"	36"	11 1/2"	1			\$ 1,188	
	DM-3612-A-SL-36-PB	Single Face Adder	36 1/4"	12 1/8"	36"	11 1/2"	1	50.6 Lbs.	4 Cu Ft	\$ 863	
 Model Shown M4212-S-SL-36-PB	DM-4210-S-SL-24-PB	Single Face Starter	25 1/4"	10 1/8"	42"	9 1/2"	2			\$ 1,594	
	DM-4210-A-SL-24-PB	Single Face Adder	24 1/4"	10 1/8"	42"	9 1/2"	2			\$ 1,294	
	DM-4212-S-SL-24-PB	Single Face Starter	25 1/4"	12 1/8"	42"	11 1/2"	2			\$ 1,644	
	DM-4212-A-SL-24-PB	Single Face Adder	24 1/4"	12 1/8"	42"	11 1/2"	2			\$ 1,325	
 Model Shown DM-4212-A-SL-36-PB	DM-4210-S-SL-30-PB	Single Face Starter	31 1/4"	10 1/8"	42"	9 1/2"	2			\$ 1,594	
	DM-4210-A-SL-30-PB	Single Face Adder	30 1/4"	10 1/8"	42"	9 1/2"	2			\$ 1,294	
	DM-4212-S-SL-30-PB	Single Face Starter	31 1/4"	12 1/8"	42"	11 1/2"	2			\$ 1,644	
	DM-4212-A-SL-30-PB	Single Face Adder	30 1/4"	12 1/8"	42"	11 1/2"	2			\$ 1,325	
 Model Shown DM-4212-A-SL-36-PB	DM-4210-S-SL-36-PB	Single Face Starter	37 1/4"	10 1/8"	42"	9 1/2"	2			\$ 1,444	
	DM-4210-A-SL-36-PB	Single Face Adder	36 1/4"	10 1/8"	42"	9 1/2"	2			\$ 1,119	
	DM-4212-S-SL-36-PB	Single Face Starter	37 1/4"	12 1/8"	42"	11 1/2"	2			\$ 1,488	
	DM-4212-A-SL-36-PB	Single Face Adder	36 1/4"	12 1/8"	42"	11 1/2"	2	55 Lbs.	5 Cu Ft	\$ 1,175	

SHELVING

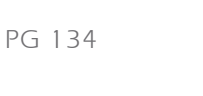
MODEL NUMBER	PRODUCT	WIDTH	DEPTH	HEIGHT	SHELF DEPTH	# OF SHELVES	# OF OPENINGS	WEIGHT	VOLUME	LIST PRICE	DESCRIPTION
	DM-4810-S-SL-24-PB	Single Face Starter	25 1/4"	10 1/8"	48"	9 1/2"	2			\$ 1,619	End, Mid, Top and Base Panels to be constructed from 1" thick 11-ply solid core, veneered 2 sides. Vertical, top and bottom edges banded with 1/4" external hardwood edging, edges to be eased. Front Edge: 3/4" thick x 2 1/2" high fascia - tongue and grooved to top.
	DM-4810-A-SL-24-PB	Single Face Adder	24 1/4"	10 1/8"	48"	9 1/2"	2			\$ 1,294	
	DM-4812-S-SL-24-PB	Single Face Starter	25 1/4"	12 1/8"	48"	11 1/2"	2			\$ 1,656	
	DM-4812-A-SL-24-PB	Single Face Adder	24 1/4"	12 1/8"	48"	11 1/2"	2			\$ 1,325	
	DM-4810-S-SL-30-PB	Single Face Starter	31 1/4"	10 1/8"	48"	9 1/2"	2			\$ 1,619	
	DM-4810-A-SL-30-PB	Single Face Adder	30 1/4"	10 1/8"	48"	9 1/2"	2			\$ 1,294	
	DM-4812-S-SL-30-PB	Single Face Starter	31 1/4"	12 1/8"	48"	11 1/2"	2			\$ 1,656	
	DM-4812-A-SL-30-PB	Single Face Adder	30 1/4"	12 1/8"	48"	11 1/2"	2			\$ 1,325	
	DM-4810-S-SL-36-PB	Single Face Starter	37 1/4"	10 1/8"	48"	9 1/2"	2			\$ 1,469	
	DM-4810-A-SL-36-PB	Single Face Adder	36 1/4"	10 1/8"	48"	9 1/2"	2			\$ 1,150	
	DM-4812-S-SL-36-PB	Single Face Starter	37 1/4"	12 1/8"	48"	11 1/2"	2			\$ 1,500	
	DM-4812-A-SL-36-PB	Single Face Adder	36 1/4"	12 1/8"	48"	11 1/2"	2	71.3 Lbs.	6 Cu Ft	\$ 1,175	
	DM-6010-S-SL-24-PB	Single Face Starter	25 1/4"	10 1/8"	60"	9 1/2"	3			\$ 1,856	
	DM-6010-A-SL-24-PB	Single Face Adder	24 1/4"	10 1/8"	60"	9 1/2"	3			\$ 1,550	
	DM-6012-S-SL-24-PB	Single Face Starter	25 1/4"	12 1/8"	60"	11 1/2"	3			\$ 1,894	
	DM-6012-A-SL-24-PB	Single Face Adder	24 1/4"	12 1/8"	60"	11 1/2"	3			\$ 1,581	
	DM-6010-S-SL-30-PB	Single Face Starter	31 1/4"	10 1/8"	60"	9 1/2"	3			\$ 1,856	
	DM-6010-A-SL-30-PB	Single Face Adder	30 1/4"	10 1/8"	60"	9 1/2"	3			\$ 1,550	
	DM-6012-S-SL-30-PB	Single Face Starter	31 1/4"	12 1/8"	60"	11 1/2"	3			\$ 1,894	
	DM-6012-A-SL-30-PB	Single Face Adder	30 1/4"	12 1/8"	60"	11 1/2"	3			\$ 1,581	
	DM-6010-S-SL-36-PB	Single Face Starter	37 1/4"	10 1/8"	60"	9 1/2"	3			\$ 1,700	
	DM-6010-A-SL-36-PB	Single Face Adder	36 1/4"	10 1/8"	60"	9 1/2"	3			\$ 1,400	
	DM-6012-S-SL-36-PB	Single Face Starter	37 1/4"	12 1/8"	60"	11 1/2"	3			\$ 1,738	
	DM-6012-A-SL-36-PB	Single Face Adder	36 1/4"	12 1/8"	60"	11 1/2"	3	95.5 Lbs.	7 Cu Ft	\$ 1,425	

SHELVING

MODEL NUMBER	PRODUCT	WIDTH	DEPTH	HEIGHT	SHELF DEPTH	# OF SHELVES	# OF OPENINGS	WEIGHT	VOLUME	LIST PRICE	DESCRIPTION
DM-7210-S-SL-24-PB	Single Face Starter	25 1/4"	10 1/8"	72"	9 1/2"	4	5			\$ 2,056	End, Mid, Top and Base Panels to be constructed from 1" thick 11-ply solid core, veneered 2 sides. Vertical, top and bottom edges banded with 1/4" external hardwood edging, edges to be eased. Front Edge: 3/4" thick x 2 1/2" high fascia - tongue and grooved to top.
DM-7210-A-SL-24-PB	Single Face Adder	24 1/4"	10 1/8"	72"	9 1/2"	4	5			\$ 1,750	
DM-7212-S-SL-24-PB	Single Face Starter	25 1/4"	12 1/8"	72"	11 1/2"	4	5			\$ 2,106	
DM-7212-A-SL-24-PB	Single Face Adder	24 1/4"	12 1/8"	72"	11 1/2"	4	5			\$ 1,794	
DM-7210-S-SL-30-PB	Single Face Starter	31 1/4"	10 1/8"	72"	9 1/2"	4	5			\$ 2,056	
DM-7210-A-SL-30-PB	Single Face Adder	30 1/4"	10 1/8"	72"	9 1/2"	4	5			\$ 1,750	
DM-7212-S-SL-30-PB	Single Face Starter	31 1/4"	12 1/8"	72"	11 1/2"	4	5			\$ 2,106	
DM-7212-A-SL-30-PB	Single Face Adder	30 1/4"	12 1/8"	72"	11 1/2"	4	5			\$ 1,794	
DM-7210-S-SL-36-PB	Single Face Starter	37 1/4"	10 1/8"	72"	9 1/2"	4	5	115 Lbs.	7 Cu Ft	\$ 1,906	
DM-7210-A-SL-36-PB	Single Face Adder	36 1/4"	10 1/8"	72"	9 1/2"	4	5	96.6 Lbs.	7 Cu Ft	\$ 1,594	
DM-7212-S-SL-36-PB	Single Face Starter	37 1/4"	12 1/8"	72"	11 1/2"	4	5	131 Lbs.	8 Cu Ft	\$ 1,963	
DM-7212-A-SL-36-PB	Single Face Adder	36 1/4"	12 1/8"	72"	11 1/2"	4	5	109 Lbs.	8 Cu Ft	\$ 1,644	
DM-8210-S-SL-24-PB	Single Face Starter	25 1/4"	10 1/8"	82"	9 1/2"	5	6			\$ 2,256	
DM-8210-A-SL-24-PB	Single Face Adder	24 1/4"	10 1/8"	82"	9 1/2"	5	6			\$ 1,963	
DM-8212-S-SL-24-PB	Single Face Starter	25 1/4"	12 1/8"	82"	11 1/2"	5	6			\$ 2,319	
DM-8212-A-SL-24-PB	Single Face Adder	24 1/4"	12 1/8"	82"	11 1/2"	5	6			\$ 2,000	
DM-8210-S-SL-30-PB	Single Face Starter	31 1/4"	10 1/8"	82"	9 1/2"	5	6			\$ 2,256	
DM-8210-A-SL-30-PB	Single Face Adder	30 1/4"	10 1/8"	82"	9 1/2"	5	6			\$ 1,963	
DM-8212-S-SL-30-PB	Single Face Starter	31 1/4"	12 1/8"	82"	11 1/2"	5	6			\$ 2,319	
DM-8212-A-SL-30-PB	Single Face Adder	30 1/4"	12 1/8"	82"	11 1/2"	5	6			\$ 2,000	
DM-8210-S-SL-36-PB	Single Face Starter	37 1/4"	10 1/8"	82"	9 1/2"	5	6	129 Lbs.	8 Cu Ft	\$ 2,106	
DM-8210-A-SL-36-PB	Single Face Adder	36 1/4"	10 1/8"	82"	9 1/2"	5	6	107 Lbs.	7 Cu Ft	\$ 1,806	
DM-8212-S-SL-36-PB	Single Face Starter	37 1/4"	12 1/8"	82"	11 1/2"	5	6	145 Lbs.	9 Cu Ft	\$ 2,169	
DM-8212-A-SL-36-PB	Single Face Adder	36 1/4"	12 1/8"	82"	11 1/2"	5	6	122 Lbs.	8 Cu Ft	\$ 1,850	



Model Shown
DM-7212-S-SL-36-PB



Model Shown
DM-7212-A-SL-36-PB



Model Shown
DM-8212-S-SL-36-PB



Model Shown
DM-8212-A-SL-36-PB

SHELVING

MODEL NUMBER	PRODUCT	WIDTH	DEPTH	HEIGHT	SHELF DEPTH	# OF SHELVES	# OF OPENINGS	WEIGHT	VOLUME	LIST PRICE	DESCRIPTION
DM-9610-S-SL-24-PB	Single Face Starter	25 1/4"	10 1/8"	96"	9 1/2"	6	7			\$ 2,469	End, Mid, Top and Base Panels to be constructed from 1" thick 11-ply solid core, veneered 2 sides. Vertical, top and bottom edges banded with 1/4" external hardwood edging, edges to be eased. Front Edge: 3/4" thick x 2 1/2" high fascia - tongue and grooved to top.
DM-9610-A-SL-24-PB	Single Face Adder	24 1/4"	10 1/8"	96"	9 1/2"	6	7			\$ 2,156	
DM-9612-S-SL-24-PB	Single Face Starter	25 1/4"	12 1/8"	96"	11 1/2"	6	7			\$ 2,531	
DM-9612-A-SL-24-PB	Single Face Adder	24 1/4"	12 1/8"	96"	11 1/2"	6	7			\$ 2,238	
DM-9610-S-SL-30-PB	Single Face Starter	31 1/4"	10 1/8"	96"	9 1/2"	6	7			\$ 2,469	
DM-9610-A-SL-30-PB	Single Face Adder	30 1/4"	10 1/8"	96"	9 1/2"	6	7			\$ 2,156	
DM-9612-S-SL-30-PB	Single Face Starter	31 1/4"	12 1/8"	96"	11 1/2"	6	7			\$ 2,531	
DM-9612-A-SL-30-PB	Single Face Adder	30 1/4"	12 1/8"	96"	11 1/2"	6	7			\$ 2,238	
DM-9610-S-SL-36-PB	Single Face Starter	37 1/4"	10 1/8"	96"	9 1/2"	6	7	156 Lbs.	9 Cu Ft	\$ 2,313	
DM-9610-A-SL-36-PB	Single Face Adder	36 1/4"	10 1/8"	96"	9 1/2"	6	7	128 Lbs.	8 Cu Ft	\$ 2,000	
DM-9612-S-SL-36-PB	Single Face Starter	37 1/4"	12 1/8"	96"	11 1/2"	6	7	177 Lbs.	10 Cu Ft	\$ 2,375	
DM-9612-A-SL-36-PB	Single Face Adder	36 1/4"	12 1/8"	96"	11 1/2"	6	7	145 Lbs.	9 Cu Ft	\$ 2,081	



Model Shown
DM-9612-S-SL-36-PB



Model Shown
DM-9612-A-SL-36-PB

SHELVING

MODEL NUMBER	PRODUCT	WIDTH	DEPTH	HEIGHT	SHELF DEPTH	# OF SHELVES	# OF OPENINGS	WEIGHT	VOLUME	LIST PRICE	DESCRIPTION
--------------	---------	-------	-------	--------	-------------	--------------	---------------	--------	--------	------------	-------------



Model Shown
M3624-SL-36-PB

DM-3620-S-SL-24-PB	Double Face Starter	25 1/4"	19 1/2"	36"	9 1/2"	2	4			\$ 2,288	End, Mid, Top and Base Panels to be constructed from 1" thick 11-ply solid core, veneered 2 sides. Vertical, top and bottom edges banded with 1/4" external hardwood edging, edges to be eased. Front Edge: 3/4" thick x 2 1/2" high fascia - tongue and grooved to top.
DM-3620-A-SL-24-PB	Double Face Adder	24 1/4"	19 1/2"	36"	9 1/2"	2	4			\$ 1,756	
DM-3624-S-SL-24-PB	Double Face Starter	25 1/4"	23 1/2"	36"	11 1/2"	2	4			\$ 2,325	
DM-3624-A-SL-24-PB	Double Face Adder	24 1/4"	23 1/2"	36"	11 1/2"	2	4			\$ 1,769	

DM-3620-S-SL-30-PB	Double Face Starter	31 1/4"	19 1/2"	36"	9 1/2"	2	4			\$ 2,288
DM-3620-A-SL-30-PB	Double Face Adder	30 1/4"	19 1/2"	36"	9 1/2"	2	4			\$ 1,756
DM-3624-S-SL-30-PB	Double Face Starter	31 1/4"	23 1/2"	36"	11 1/2"	2	4			\$ 2,325
DM-3624-A-SL-30-PB	Double Face Adder	30 1/4"	23 1/2"	36"	11 1/2"	2	4			\$ 1,769



Model Shown
DM-3624-A-SL-36-PB

DM-3620-S-SL-36-PB	Double Face Starter	37 1/4"	19 1/2"	36"	9 1/2"	2	4	88.6 Lbs.	7 Cu Ft	\$ 2,050
DM-3620-A-SL-36-PB	Double Face Adder	36 1/4"	19 1/2"	36"	9 1/2"	2	4	73.6 Lbs.	6 Cu Ft	\$ 1,525
DM-3624-S-SL-36-PB	Double Face Starter	37 1/4"	23 1/2"	36"	11 1/2"	2	4	110 Lbs.	10 Cu Ft	\$ 2,094
DM-3624-A-SL-36-PB	Double Face Adder	36 1/4"	23 1/2"	36"	11 1/2"	2	4	88.6 Lbs.	9 Cu Ft	\$ 1,544



Model Shown
M4224-S-SL-36-PB

DM-4220-S-SL-24-PB	Double Face Starter	25 1/4"	19 1/2"	42"	9 1/2"	4	6			\$ 2,656
DM-4220-A-SL-24-PB	Double Face Adder	24 1/4"	19 1/2"	42"	9 1/2"	4	6			\$ 2,119
DM-4224-S-SL-24-PB	Double Face Starter	25 1/4"	23 1/2"	42"	11 1/2"	4	6			\$ 2,694
DM-4224-A-SL-24-PB	Double Face Adder	24 1/4"	23 1/2"	42"	11 1/2"	4	6			\$ 2,138

DM-4220-S-SL-30-PB	Double Face Starter	31 1/4"	19 1/2"	42"	9 1/2"	4	6			\$ 2,656
DM-4220-A-SL-30-PB	Double Face Adder	30 1/4"	19 1/2"	42"	9 1/2"	4	6			\$ 2,119
DM-4224-S-SL-30-PB	Double Face Starter	31 1/4"	23 1/2"	42"	11 1/2"	4	6			\$ 2,694
DM-4224-A-SL-30-PB	Double Face Adder	30 1/4"	23 1/2"	42"	11 1/2"	4	6			\$ 2,138



Model Shown
DM-4224-A-SL-36-PB

DM-4220-S-SL-36-PB	Double Face Starter	37 1/4"	19 1/2"	42"	9 1/2"	4	6	94 Lbs.	7 Cu Ft	\$ 2,431
DM-4220-A-SL-36-PB	Double Face Adder	36 1/4"	19 1/2"	42"	9 1/2"	4	6	78 Lbs.	7 Cu Ft	\$ 1,881
DM-4224-S-SL-36-PB	Double Face Starter	37 1/4"	23 1/2"	42"	11 1/2"	4	6	115 Lbs.	10 Cu Ft	\$ 2,463
DM-4224-A-SL-36-PB	Double Face Adder	36 1/4"	23 1/2"	42"	11 1/2"	4	6	113 Lbs.	10 Cu Ft	\$ 1,900

SHELVING

MODEL NUMBER	PRODUCT	WIDTH	DEPTH	HEIGHT	SHELF DEPTH	# OF SHELVES	# OF OPENINGS	WEIGHT	VOLUME	LIST PRICE	DESCRIPTION
--------------	---------	-------	-------	--------	-------------	--------------	---------------	--------	--------	------------	-------------



Model Shown
M4224-S-SL-36-PB

DM4820-S-SL-24-PB	Double Face Starter	25 1/4"	19 1/2"	48"	9 1/2"	4	6			\$ 2,731	End, Mid, Top and Base Panels to be constructed from 1" thick 11-ply solid core, veneered 2 sides. Vertical, top and bottom edges banded with 1/4" external hardwood edging, edges to be eased. Front Edge: 3/4" thick x 2 1/2" high fascia - tongue and grooved to top.
DM4820-A-SL-24-PB	Double Face Adder	24 1/4"	19 1/2"	48"	9 1/2"	4	6			\$ 2,344	
DM4824-S-SL-24-PB	Double Face Starter	25 1/4"	23 1/2"	48"	11 1/2"	4	6			\$ 2,919	
DM4824-A-SL-24-PB	Double Face Adder	24 1/4"	23 1/2"	48"	11 1/2"	4	6			\$ 2,369	
DM4820-S-SL-30-PB	Double Face Starter	31 1/4"	19 1/2"	48"	9 1/2"	4	6			\$ 2,731	
DM4820-A-SL-30-PB	Double Face Adder	30 1/4"	19 1/2"	48"	9 1/2"	4	6			\$ 2,344	
DM4824-S-SL-30-PB	Double Face Starter	31 1/4"	23 1/2"	48"	11 1/2"	4	6			\$ 2,919	
DM4824-A-SL-30-PB	Double Face Adder	30 1/4"	23 1/2"	48"	11 1/2"	4	6			\$ 2,369	



Model Shown
DM-4224-A-SL-36-PB

DM4820-S-SL-36-PB	Double Face Starter	37 1/4"	19 1/2"	48"	9 1/2"	4	6	132 Lbs.	9 Cu Ft	\$ 2,638
DM4820-A-SL-36-PB	Double Face Adder	36 1/4"	19 1/2"	48"	9 1/2"	4	6	109 Lbs.	8 Cu Ft	\$ 2,106
DM4824-S-SL-36-PB	Double Face Starter	37 1/4"	23 1/2"	48"	11 1/2"	4	6	155 Lbs.	11 Cu Ft	\$ 2,681
DM4824-A-SL-36-PB	Double Face Adder	36 1/4"	23 1/2"	48"	11 1/2"	4	6	127 Lbs.	10 Cu Ft	\$ 2,138



Model Shown
DM-6024-S-SL-36-PB



DM6020-S-SL-24-PB	Double Face Starter	25 1/4"	19 1/2"	60"	9 1/2"	6	8			\$ 3,313
DM6020-A-SL-24-PB	Double Face Adder	24 1/4"	19 1/2"	60"	9 1/2"	6	8			\$ 2,756
DM6024-S-SL-24-PB	Double Face Starter	25 1/4"	23 1/2"	60"	11 1/2"	6	8			\$ 3,344
DM6024-A-SL-24-PB	Double Face Adder	24 1/4"	23 1/2"	60"	11 1/2"	6	8			\$ 2,806
DM6020-S-SL-30-PB	Double Face Starter	31 1/4"	19 1/2"	60"	9 1/2"	6	8			\$ 3,313
DM6020-A-SL-30-PB	Double Face Adder	30 1/4"	19 1/2"	60"	9 1/2"	6	8			\$ 2,756
DM6024-S-SL-30-PB	Double Face Starter	31 1/4"	23 1/2"	60"	11 1/2"	6	8			\$ 3,344
DM6024-A-SL-30-PB	Double Face Adder	30 1/4"	23 1/2"	60"	11 1/2"	6	8			\$ 2,806



Model Shown
DM-6024-A-SL-36-PB

DM6020-S-SL-36-PB	Double Face Starter	37 1/4"	19 1/2"	60"	9 1/2"	6	8	176 Lbs.	11 Cu Ft	\$ 3,069
DM6020-A-SL-36-PB	Double Face Adder	36 1/4"	19 1/2"	60"	9 1/2"	6	8	145 Lbs.	10 Cu Ft	\$ 2,525
DM6024-S-SL-36-PB	Double Face Starter	37 1/4"	23 1/2"	60"	11 1/2"	6	8	200 Lbs.	12 Cu Ft	\$ 3,119
DM6024-A-SL-36-PB	Double Face Adder	36 1/4"	23 1/2"	60"	11 1/2"	6	8	164 Lbs.	11 Cu Ft	\$ 2,581

SHELVING

MODEL NUMBER	PRODUCT	WIDTH	DEPTH	HEIGHT	SHELF DEPTH	# OF SHELVES	# OF OPENINGS	WEIGHT	VOLUME	LIST PRICE	DESCRIPTION	
 <p>Model Shown DM-7224-S-SL-36-PB</p>	DM-7220-S-SL-24-PB	Double Face Starter	25 1/4"	19 1/2"	72"	9 1/2"	8	10		\$ 3,719	End, Mid, Top and Base Panels to be constructed from 1" thick 11-ply solid core, veneered 2 sides. Vertical, top and bottom edges banded with 1/4" external hardwood edging, edges to be eased. Front Edge: 3/4" thick x 2 1/2" high fascia - tongue and grooved to top.	
	DM-7220-A-SL-24-PB	Double Face Adder	24 1/4"	19 1/2"	72"	9 1/2"	8	10		\$ 3,163		
	DM-7224-S-SL-24-PB	Double Face Starter	25 1/4"	23 1/2"	72"	11 1/2"	8	10		\$ 3,769		
	DM-7224-A-SL-24-PB	Double Face Adder	24 1/4"	23 1/2"	72"	11 1/2"	8	10		\$ 3,219		
	DM-7220-S-SL-30-PB	Double Face Starter	31 1/4"	19 1/2"	72"	9 1/2"	8	10		\$ 3,719		
	DM-7220-A-SL-30-PB	Double Face Adder	30 1/4"	19 1/2"	72"	9 1/2"	8	10		\$ 3,163		
	DM-7224-S-SL-30-PB	Double Face Starter	31 1/4"	23 1/2"	72"	11 1/2"	8	10		\$ 3,769		
	DM-7224-A-SL-30-PB	Double Face Adder	30 1/4"	23 1/2"	72"	11 1/2"	8	10		\$ 3,219		
	DM-7220-S-SL-36-PB	Double Face Starter	37 1/4"	19 1/2"	72"	9 1/2"	8	10	200 Lbs.	12 Cu Ft		\$ 3,488
	DM-7220-A-SL-36-PB	Double Face Adder	36 1/4"	19 1/2"	72"	9 1/2"	8	10	164 Lbs.	11 Cu Ft		\$ 2,938
	DM-7224-S-SL-36-PB	Double Face Starter	37 1/4"	23 1/2"	72"	11 1/2"	8	10	229 Lbs.	13 Cu Ft		\$ 3,544
	DM-7224-A-SL-36-PB	Double Face Adder	36 1/4"	23 1/2"	72"	11 1/2"	8	10	186 Lbs.	12 Cu Ft		\$ 2,988
 <p>Model Shown DM-8224-S-SL-36-PB</p>	DM-8220-S-SL-24-PB	Double Face Starter	25 1/4"	19 1/2"	82"	9 1/2"	10	12		\$ 3,988		
	DM-8220-A-SL-24-PB	Double Face Adder	24 1/4"	19 1/2"	82"	9 1/2"	10	12		\$ 3,444		
	DM-8224-S-SL-24-PB	Double Face Starter	25 1/4"	23 1/2"	82"	11 1/2"	10	12		\$ 4,056		
	DM-8224-A-SL-24-PB	Double Face Adder	24 1/4"	23 1/2"	82"	11 1/2"	10	12		\$ 3,506		
	DM-8220-S-SL-30-PB	Double Face Starter	31 1/4"	19 1/2"	82"	9 1/2"	10	12		\$ 3,988		
	DM-8220-A-SL-30-PB	Double Face Adder	30 1/4"	19 1/2"	82"	9 1/2"	10	12		\$ 3,444		
	DM-8224-S-SL-30-PB	Double Face Starter	31 1/4"	23 1/2"	82"	11 1/2"	10	12		\$ 4,056		
	DM-8224-A-SL-30-PB	Double Face Adder	30 1/4"	23 1/2"	82"	11 1/2"	10	12		\$ 3,506		
	DM-8220-S-SL-36-PB	Double Face Starter	37 1/4"	19 1/2"	82"	9 1/2"	10	12	224 Lbs.	12 Cu Ft	\$ 3,756	
	DM-8220-A-SL-36-PB	Double Face Adder	36 1/4"	19 1/2"	82"	9 1/2"	10	12	184 Lbs.	11 Cu Ft	\$ 3,206	
	DM-8224-S-SL-36-PB	Double Face Starter	37 1/4"	23 1/2"	82"	11 1/2"	10	12	256 Lbs.	14 Cu Ft	\$ 3,819	
	DM-8224-A-SL-36-PB	Double Face Adder	36 1/4"	23 1/2"	82"	11 1/2"	10	12	207 Lbs.	12 Cu Ft	\$ 3,281	

SHELVING

MODEL NUMBER	PRODUCT	WIDTH	DEPTH	HEIGHT	SHELF DEPTH	# OF SHELVES	# OF OPENINGS	WEIGHT	VOLUME	LIST PRICE	DESCRIPTION
DM-9620-S-SL-24-PB	Double Face Starter	25 1/4"	19 1/2"	96"	9 1/2"	12	14			\$ 4,269	End, Mid, Top and Base Panels to be constructed from 1" thick 11-ply solid core, veneered 2 sides. Vertical, top and bottom edges banded with 1/4" external hardwood edging, edges to be eased. Front Edge: 3/4" thick x 2 1/2" high fascia - tongue and grooved to top.
DM-9620-A-SL-24-PB	Double Face Adder	24 1/4"	19 1/2"	96"	9 1/2"	12	14			\$ 3,719	
DM-9624-S-SL-24-PB	Double Face Starter	25 1/4"	23 1/2"	96"	11 1/2"	12	14			\$ 4,344	
DM-9624-A-SL-24-PB	Double Face Adder	24 1/4"	23 1/2"	96"	11 1/2"	12	14			\$ 3,800	
DM-9620-S-SL-30-PB	Double Face Starter	31 1/4"	19 1/2"	96"	9 1/2"	12	14			\$ 4,269	
DM-9620-A-SL-30-PB	Double Face Adder	30 1/4"	19 1/2"	96"	9 1/2"	12	14			\$ 3,719	
DM-9624-S-SL-30-PB	Double Face Starter	31 1/4"	23 1/2"	96"	11 1/2"	12	14			\$ 4,344	
DM-9624-A-SL-30-PB	Double Face Adder	30 1/4"	23 1/2"	96"	11 1/2"	12	14			\$ 3,800	
DM-9620-S-SL-36-PB	Double Face Starter	37 1/4"	19 1/2"	96"	9 1/2"	12	14	276 Lbs.	13 Cu Ft	\$ 4,031	
DM-9620-A-SL-36-PB	Double Face Adder	36 1/4"	19 1/2"	96"	9 1/2"	12	14	220 Lbs.	12 Cu Ft	\$ 3,481	
DM-9624-S-SL-36-PB	Double Face Starter	37 1/4"	23 1/2"	96"	11 1/2"	12	14	315 Lbs.	15 Cu Ft	\$ 4,106	
DM-9624-A-SL-36-PB	Double Face Adder	36 1/4"	23 1/2"	96"	11 1/2"	12	14	247 Lbs.	13 Cu Ft	\$ 3,569	





Model Shown
DM-9624-S-SL-36-PB





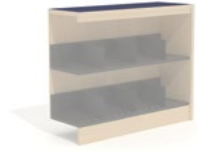

Model Shown
DM-9624-A-SL-36-PB





SHELVING



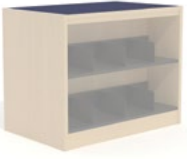

	MODEL NUMBER	PRODUCT	WIDTH	DEPTH	HEIGHT	SHELF DEPTH	# OF SHELVES	# OF OPENINGS	WEIGHT	VOLUME	LIST PRICE	DESCRIPTION
	DM-3610-S-SL-24-PB-IPT	Single Face Starter	25 1/4"	10 1/8"	36"	9 1/2"	1	2			\$ 1,369	End, Mid, Top and Base Panels to be constructed from 1" thick 11-ply solid core, veneered 2 sides. Vertical, top and bottom edges banded with 1/4" external hardwood edging, edges to be eased. Front Edge: 3/4" thick x 2 1/2" high fascia - tongue and grooved to top.
	DM-3610-A-SL-24-PB-IPT	Single Face Adder	24 1/4"	10 1/8"	36"	9 1/2"	1	2			\$ 1,063	
	DM-3612-S-SL-24-PB-IPT	Single Face Starter	25 1/4"	12 1/8"	36"	11 1/2"	1	2			\$ 1,413	
	DM-3612-A-SL-24-PB-IPT	Single Face Adder	24 1/4"	12 1/8"	36"	11 1/2"	1	2			\$ 1,094	
Model Shown M3612-S-SL-36-PB-IPT	DM-3610-S-SL-30-PB-IPT	Single Face Starter	31 1/4"	10 1/8"	36"	9 1/2"	1	2			\$ 1,369	
	DM-3610-A-SL-30-PB-IPT	Single Face Adder	30 1/4"	10 1/8"	36"	9 1/2"	1	2			\$ 1,063	
	DM-3612-S-SL-30-PB-IPT	Single Face Starter	31 1/4"	12 1/8"	36"	11 1/2"	1	2			\$ 1,413	
	DM-3612-A-SL-30-PB-IPT	Single Face Adder	30 1/4"	12 1/8"	36"	11 1/2"	1	2			\$ 1,094	
	DM-3610-S-SL-36-PB-IPT	Single Face Starter	37 1/4"	10 1/8"	36"	9 1/2"	1	2	50.6 Lbs.	4 Cu Ft	\$ 1,213	
	DM-3610-A-SL-36-PB-IPT	Single Face Adder	36 1/4"	10 1/8"	36"	9 1/2"	1	2	46 Lbs.	4 Cu Ft	\$ 913	
	DM-3612-S-SL-36-PB-IPT	Single Face Starter	37 1/4"	12 1/8"	36"	11 1/2"	1	2	50.6 Lbs.	5 Cu Ft	\$ 1,263	
	DM-3612-A-SL-36-PB-IPT	Single Face Adder	36 1/4"	12 1/8"	36"	11 1/2"	1	2	47.2 Lbs.	5 Cu Ft	\$ 938	
Model Shown DM-3612-A-SL-36-PB-IPT	DM-4210-S-SL-24-PB-IPT	Single Face Starter	25 1/4"	10 1/8"	42"	9 1/2"	2	3			\$ 1,675	
	DM-4210-A-SL-24-PB-IPT	Single Face Adder	24 1/4"	10 1/8"	42"	9 1/2"	2	3			\$ 1,375	
	DM-4212-S-SL-24-PB-IPT	Single Face Starter	25 1/4"	12 1/8"	42"	11 1/2"	2	3			\$ 1,719	
	DM-4212-A-SL-24-PB-IPT	Single Face Adder	24 1/4"	12 1/8"	42"	11 1/2"	2	3			\$ 1,400	
	DM-4210-S-SL-30-PB-IPT	Single Face Starter	31 1/4"	10 1/8"	42"	9 1/2"	2	3			\$ 1,675	
	DM-4210-A-SL-30-PB-IPT	Single Face Adder	30 1/4"	10 1/8"	42"	9 1/2"	2	3			\$ 1,375	
	DM-4212-S-SL-30-PB-IPT	Single Face Starter	31 1/4"	12 1/8"	42"	11 1/2"	2	3			\$ 1,719	
	DM-4212-A-SL-30-PB-IPT	Single Face Adder	30 1/4"	12 1/8"	42"	11 1/2"	2	3			\$ 1,400	
Model Shown M4212-S-SL-36-PB-IPT	DM-4210-S-SL-36-PB-IPT	Single Face Starter	37 1/4"	10 1/8"	42"	9 1/2"	2	3	55 Lbs.	5 Cu Ft	\$ 1,519	
	DM-4210-A-SL-36-PB-IPT	Single Face Adder	36 1/4"	10 1/8"	42"	9 1/2"	2	3	52 Lbs.	5 Cu Ft	\$ 1,194	
	DM-4212-S-SL-36-PB-IPT	Single Face Starter	37 1/4"	12 1/8"	42"	11 1/2"	2	3	60 Lbs.	5 Cu Ft	\$ 1,563	
	DM-4212-A-SL-36-PB-IPT	Single Face Adder	36 1/4"	12 1/8"	42"	11 1/2"	2	3	53 Lbs.	5 Cu Ft	\$ 1,250	
Model Shown DM-4212-A-SL-36-PB-IPT												

SHELVING

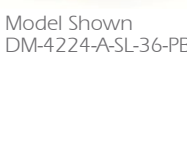
	MODEL NUMBER	PRODUCT	WIDTH	DEPTH	HEIGHT	SHELF DEPTH	# OF SHELVES	# OF OPENINGS	WEIGHT	VOLUME	LIST PRICE	DESCRIPTION
 <p>Model Shown DM-4212-S-SL-36-PB-IPT</p>	DM-4810-S-SL-24-PB-IPT	Single Face Starter	25 1/4"	10 1/8"	48"	9 1/2"	2	3			\$ 1,694	End, Mid, Top and Base Panels to be constructed from 1" thick 11-ply solid core, veneered 2 sides. Vertical, top and bottom edges banded with 1/4" external hardwood edging, edges to be eased. Front Edge: 3/4" thick x 2 1/2" high fascia - tongue and grooved to top.
	DM-4810-A-SL-24-PB-IPT	Single Face Adder	24 1/4"	10 1/8"	48"	9 1/2"	2	3			\$ 1,375	
	DM-4812-S-SL-24-PB-IPT	Single Face Starter	25 1/4"	12 1/8"	48"	11 1/2"	2	3			\$ 1,731	
	DM-4812-A-SL-24-PB-IPT	Single Face Adder	24 1/4"	12 1/8"	48"	11 1/2"	2	3			\$ 1,400	
 <p>Model Shown DM-4212-A-SL-36-PB-IPT</p>	DM-4810-S-SL-30-PB-IPT	Single Face Starter	31 1/4"	10 1/8"	48"	9 1/2"	2	3			\$ 1,694	
	DM-4810-A-SL-30-PB-IPT	Single Face Adder	30 1/4"	10 1/8"	48"	9 1/2"	2	3			\$ 1,375	
	DM-4812-S-SL-30-PB-IPT	Single Face Starter	31 1/4"	12 1/8"	48"	11 1/2"	2	3			\$ 1,731	
	DM-4812-A-SL-30-PB-IPT	Single Face Adder	30 1/4"	12 1/8"	48"	11 1/2"	2	3			\$ 1,400	
 <p>Model Shown DM-6012-A-SL-36-PB-IPT</p>	DM-4810-S-SL-36-PB-IPT	Single Face Starter	37 1/4"	10 1/8"	48"	9 1/2"	2	3	74.8 Lbs.	5 Cu Ft	\$ 1,544	
	DM-4810-A-SL-36-PB-IPT	Single Face Adder	36 1/4"	10 1/8"	48"	9 1/2"	2	3	65.5 Lbs.	5 Cu Ft	\$ 1,225	
	DM-4812-S-SL-36-PB-IPT	Single Face Starter	37 1/4"	12 1/8"	48"	11 1/2"	2	3	82.8 Lbs.	6 Cu Ft	\$ 1,575	
	DM-4812-A-SL-36-PB-IPT	Single Face Adder	36 1/4"	12 1/8"	48"	11 1/2"	2	3	71.3 Lbs.	6 Cu Ft	\$ 1,250	
 <p>Model Shown DM-6012-S-SL-36-PB-IPT</p>	DM-6010-S-SL-24-PB-IPT	Single Face Starter	25 1/4"	10 1/8"	60"	9 1/2"	3	4			\$ 1,931	
	DM-6010-A-SL-24-PB-IPT	Single Face Adder	24 1/4"	10 1/8"	60"	9 1/2"	3	4			\$ 1,631	
	DM-6012-S-SL-24-PB-IPT	Single Face Starter	25 1/4"	12 1/8"	60"	11 1/2"	3	4			\$ 1,975	
	DM-6012-A-SL-24-PB-IPT	Single Face Adder	24 1/4"	12 1/8"	60"	11 1/2"	3	4			\$ 1,663	
 <p>Model Shown DM-6012-A-SL-36-PB-IPT</p>	DM-6010-S-SL-30-PB-IPT	Single Face Starter	31 1/4"	10 1/8"	60"	9 1/2"	3	4			\$ 1,931	
	DM-6010-A-SL-30-PB-IPT	Single Face Adder	30 1/4"	10 1/8"	60"	9 1/2"	3	4			\$ 1,631	
	DM-6012-S-SL-30-PB-IPT	Single Face Starter	31 1/4"	12 1/8"	60"	11 1/2"	3	4			\$ 1,975	
	DM-6012-A-SL-30-PB-IPT	Single Face Adder	30 1/4"	12 1/8"	60"	11 1/2"	3	4			\$ 1,663	
	DM-6010-S-SL-36-PB-IPT	Single Face Starter	37 1/4"	10 1/8"	60"	9 1/2"	3	4	100 Lbs.	6 Cu Ft	\$ 1,781	
	DM-6010-A-SL-36-PB-IPT	Single Face Adder	36 1/4"	10 1/8"	60"	9 1/2"	3	4	86.3 Lbs.	6 Cu Ft	\$ 1,481	
	DM-6012-S-SL-36-PB-IPT	Single Face Starter	37 1/4"	12 1/8"	60"	11 1/2"	3	4	116 Lbs.	8 Cu Ft	\$ 1,819	
	DM-6012-A-SL-36-PB-IPT	Single Face Adder	36 1/4"	12 1/8"	60"	11 1/2"	3	4	95.5 Lbs.	7 Cu Ft	\$ 1,506	

SHELVING

	MODEL NUMBER	PRODUCT	WIDTH	DEPTH	HEIGHT	SHELF DEPTH	# OF SHELVES	# OF OPENINGS	WEIGHT	VOLUME	LIST PRICE	DESCRIPTION
	DM-3620-S-SL-24-PB-IPT	Double Face Starter	25 1/4"	19 1/2"	36"	9 1/2"	2	4			\$ 2,444	End, Mid, Top and Base Panels to be constructed from 1" thick 11-ply solid core, veneered 2 sides. Vertical, top and bottom edges banded with 1/4" external hardwood edging, edges to be eased. Front Edge: 3/4" thick x 2 1/2" high fascia - tongue and grooved to top.
	DM-3620-A-SL-24-PB-IPT	Double Face Adder	24 1/4"	19 1/2"	36"	9 1/2"	2	4			\$ 1,913	
	DM-3624-S-SL-24-PB-IPT	Double Face Starter	25 1/4"	23 1/2"	36"	11 1/2"	2	4			\$ 2,481	
	DM-3624-A-SL-24-PB-IPT	Double Face Adder	24 1/4"	23 1/2"	36"	11 1/2"	2	4			\$ 1,931	
	DM-3620-S-SL-30-PB-IPT	Double Face Starter	31 1/4"	19 1/2"	36"	9 1/2"	2	4			\$ 2,444	
	DM-3620-A-SL-30-PB-IPT	Double Face Adder	30 1/4"	19 1/2"	36"	9 1/2"	2	4			\$ 1,913	
	DM-3624-S-SL-30-PB-IPT	Double Face Starter	31 1/4"	23 1/2"	36"	11 1/2"	2	4			\$ 2,481	
	DM-3624-A-SL-30-PB-IPT	Double Face Adder	30 1/4"	23 1/2"	36"	11 1/2"	2	4			\$ 1,931	
	DM-3620-S-SL-36-PB-IPT	Double Face Starter	37 1/4"	19 1/2"	36"	9 1/2"	2	4	88.6 Lbs.	7 Cu Ft	\$ 2,206	
	DM-3620-A-SL-36-PB-IPT	Double Face Adder	36 1/4"	19 1/2"	36"	9 1/2"	2	4	73.6 Lbs.	6 Cu Ft	\$ 1,681	
	DM-3624-S-SL-36-PB-IPT	Double Face Starter	37 1/4"	23 1/2"	36"	11 1/2"	2	4	110 Lbs.	10 Cu Ft	\$ 2,244	
	DM-3624-A-SL-36-PB-IPT	Double Face Adder	36 1/4"	23 1/2"	36"	11 1/2"	2	4	88.6 Lbs.	9 Cu Ft	\$ 1,700	
	DM-4220-S-SL-24-PB-IPT	Double Face Starter	25 1/4"	19 1/2"	42"	9 1/2"	4	6			\$ 2,813	
	DM-4220-A-SL-24-PB-IPT	Double Face Adder	24 1/4"	19 1/2"	42"	9 1/2"	4	6			\$ 2,269	
	DM-4224-S-SL-24-PB-IPT	Double Face Starter	25 1/4"	23 1/2"	42"	11 1/2"	4	6			\$ 2,850	
	DM-4224-A-SL-24-PB-IPT	Double Face Adder	24 1/4"	23 1/2"	42"	11 1/2"	4	6			\$ 2,294	
	DM-4220-S-SL-30-PB-IPT	Double Face Starter	31 1/4"	19 1/2"	42"	9 1/2"	4	6			\$ 2,813	
	DM-4220-A-SL-30-PB-IPT	Double Face Adder	30 1/4"	19 1/2"	42"	9 1/2"	4	6			\$ 2,269	
	DM-4224-S-SL-30-PB-IPT	Double Face Starter	31 1/4"	23 1/2"	42"	11 1/2"	4	6			\$ 2,850	
	DM-4224-A-SL-30-PB-IPT	Double Face Adder	30 1/4"	23 1/2"	42"	11 1/2"	4	6			\$ 2,294	
	DM-4220-S-SL-36-PB-IPT	Double Face Starter	37 1/4"	19 1/2"	42"	9 1/2"	4	6	94 Lbs.	7 Cu Ft	\$ 2,581	
	DM-4220-A-SL-36-PB-IPT	Double Face Adder	36 1/4"	19 1/2"	42"	9 1/2"	4	6	78 Lbs.	7 Cu Ft	\$ 2,038	
	DM-4224-S-SL-36-PB-IPT	Double Face Starter	37 1/4"	23 1/2"	42"	11 1/2"	4	6	115 Lbs.	10 Cu Ft	\$ 2,619	
	DM-4224-A-SL-36-PB-IPT	Double Face Adder	36 1/4"	23 1/2"	42"	11 1/2"	4	6	113 Lbs.	10 Cu Ft	\$ 2,056	

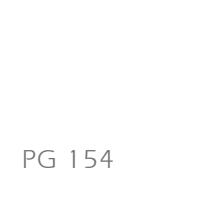
	MODEL NUMBER	PRODUCT	WIDTH	DEPTH	HEIGHT	SHELF DEPTH	# OF SHELVES	# OF OPENINGS	WEIGHT	VOLUME	LIST PRICE	DESCRIPTION
 Model Shown DM-4224-S-SL-36-PB-IPT	DM4820-S-SL-24-PB-IPT	Double Face Starter	25 1/4"	19 1/2"	48"	9 1/2"	4	6			\$ 2,881	End, Mid, Top and Base Panels to be constructed from 1" thick 11-ply solid core, veneered 2 sides. Vertical, top and bottom edges banded with 1/4" external hardwood edging, edges to be eased. Front Edge: 3/4" thick x 2 1/2" high fascia - tongue and grooved to top.
	DM4820-A-SL-24-PB-IPT	Double Face Adder	24 1/4"	19 1/2"	48"	9 1/2"	4	6			\$ 2,500	
	DM4824-S-SL-24-PB-IPT	Double Face Starter	25 1/4"	23 1/2"	48"	11 1/2"	4	6			\$ 3,069	
	DM4824-A-SL-24-PB-IPT	Double Face Adder	24 1/4"	23 1/2"	48"	11 1/2"	4	6			\$ 2,525	
 Model Shown DM-4224-A-SL-36-PB-IPT	DM4820-S-SL-30-PB-IPT	Double Face Starter	31 1/4"	19 1/2"	48"	9 1/2"	4	6			\$ 2,881	
	DM4820-A-SL-30-PB-IPT	Double Face Adder	30 1/4"	19 1/2"	48"	9 1/2"	4	6			\$ 2,500	
	DM4824-S-SL-30-PB-IPT	Double Face Starter	31 1/4"	23 1/2"	48"	11 1/2"	4	6			\$ 3,069	
	DM4824-A-SL-30-PB-IPT	Double Face Adder	30 1/4"	23 1/2"	48"	11 1/2"	4	6			\$ 2,525	
 Model Shown DM-4224-A-SL-36-PB-IPT	DM4820-S-SL-36-PB-IPT	Double Face Starter	37 1/4"	19 1/2"	48"	9 1/2"	4	6	132 Lbs.	9 Cu Ft	\$ 2,794	
	DM4820-A-SL-36-PB-IPT	Double Face Adder	36 1/4"	19 1/2"	48"	9 1/2"	4	6	109 Lbs.	8 Cu Ft	\$ 2,269	
	DM4824-S-SL-36-PB-IPT	Double Face Starter	37 1/4"	23 1/2"	48"	11 1/2"	4	6	155 Lbs.	11 Cu Ft	\$ 2,838	
	DM4824-A-SL-36-PB-IPT	Double Face Adder	36 1/4"	23 1/2"	48"	11 1/2"	4	6	127 Lbs.	10 Cu Ft	\$ 2,294	
 Model Shown DM-6024-S-SL-36-PB-IPT	DM6020-S-SL-24-PB-IPT	Double Face Starter	25 1/4"	19 1/2"	60"	9 1/2"	6	8			\$ 3,469	
	DM6020-A-SL-24-PB-IPT	Double Face Adder	24 1/4"	19 1/2"	60"	9 1/2"	6	8			\$ 2,906	
	DM6024-S-SL-24-PB-IPT	Double Face Starter	25 1/4"	23 1/2"	60"	11 1/2"	6	8			\$ 3,500	
	DM6024-A-SL-24-PB-IPT	Double Face Adder	24 1/4"	23 1/2"	60"	11 1/2"	6	8			\$ 2,963	
 Model Shown DM-6024-A-SL-36-PB-IPT	DM6020-S-SL-30-PB-IPT	Double Face Starter	31 1/4"	19 1/2"	60"	9 1/2"	6	8			\$ 3,469	
	DM6020-A-SL-30-PB-IPT	Double Face Adder	30 1/4"	19 1/2"	60"	9 1/2"	6	8			\$ 2,906	
	DM6024-S-SL-30-PB-IPT	Double Face Starter	31 1/4"	23 1/2"	60"	11 1/2"	6	8			\$ 3,500	
	DM6024-A-SL-30-PB-IPT	Double Face Adder	30 1/4"	23 1/2"	60"	11 1/2"	6	8			\$ 2,963	
 Model Shown DM-6024-A-SL-36-PB-IPT	DM6020-S-SL-36-PB-IPT	Double Face Starter	37 1/4"	19 1/2"	60"	9 1/2"	6	8	176 Lbs.	11 Cu Ft	\$ 3,256	
	DM6020-A-SL-36-PB-IPT	Double Face Adder	36 1/4"	19 1/2"	60"	9 1/2"	6	8	145 Lbs.	10 Cu Ft	\$ 2,681	
	DM6024-S-SL-36-PB-IPT	Double Face Starter	37 1/4"	23 1/2"	60"	11 1/2"	6	8	200 Lbs.	12 Cu Ft	\$ 3,275	
	DM6024-A-SL-36-PB-IPT	Double Face Adder	36 1/4"	23 1/2"	60"	11 1/2"	6	8	164 Lbs.	11 Cu Ft	\$ 2,731	

SHELVING

MODEL NUMBER	PRODUCT	WIDTH	DEPTH	HEIGHT	SHELF DEPTH	# OF SHELVES	# OF OPENINGS	WEIGHT	VOLUME	LIST PRICE	DESCRIPTION
--------------	---------	-------	-------	--------	-------------	--------------	---------------	--------	--------	------------	-------------

DM-3612-S-M-24	Single Face Starter	25 1/4"	12 1/8"	36"		1	2			\$ 1,425	End, Mid, Top and Base Panels to be constructed from 1" thick 11-ply solid core, veneered 2 sides. Vertical, top and bottom edges banded with 1/4" external hardwood edging, edges to be eased. Front Edge: 3/4" thick x 2 1/2" high fascia - tongue and grooved to top.
DM-3612-A-M-24	Single Face Adder	24 1/4"	12 1/8"	36"		1	2			\$ 1,094	
DM-3612-S-M-30	Single Face Starter	31 1/4"	12 1/8"	36"		1	2			\$ 1,425	
DM-3612-A-M-30	Single Face Adder	30 1/4"	12 1/8"	36"		1	2			\$ 1,094	
DM-3612-S-M-36	Single Face Starter	37 1/4"	12 1/8"	36"		1	2	80.5 Lbs.	6 Cu Ft	\$ 1,269	
DM-3612-A-M-36	Single Face Adder	36 1/4"	12 1/8"	36"		1	2	77.1 Lbs.	6 Cu Ft	\$ 938	



Model Shown
DM-3612-S-M-36

DM-4212-S-M-24	Single Face Starter	25 1/4"	12 1/8"	42"		2	3			\$ 1,669	
DM-4212-A-M-24	Single Face Adder	24 1/4"	12 1/8"	42"		2	3			\$ 1,344	
DM-4212-S-M-30	Single Face Starter	31 1/4"	12 1/8"	42"		2	3			\$ 1,681	
DM-4212-A-M-30	Single Face Adder	30 1/4"	12 1/8"	42"		2	3			\$ 1,344	
DM-4212-S-M-36	Single Face Starter	37 1/4"	12 1/8"	42"		2	3	82.5 Lbs.	7 Cu Ft	\$ 1,519	
DM-4212-A-M-36	Single Face Adder	36 1/4"	12 1/8"	42"		2	3	80 Lbs.	7 Cu Ft	\$ 1,188	



Model Shown
DM-4212-S-M-36

DM-4812-S-M-24	Single Face Starter	25 1/4"	12 1/8"	48"		2	3			\$ 1,769	
DM-4812-A-M-24	Single Face Adder	24 1/4"	12 1/8"	48"		2	3			\$ 1,406	
DM-4812-S-M-30	Single Face Starter	31 1/4"	12 1/8"	48"		2	3			\$ 1,769	
DM-4812-A-M-30	Single Face Adder	30 1/4"	12 1/8"	48"		2	3			\$ 1,406	
DM-4812-S-M-36	Single Face Starter	37 1/4"	12 1/8"	48"		2	3	128 Lbs.	7 Cu Ft	\$ 1,588	
DM-4812-A-M-36	Single Face Adder	36 1/4"	12 1/8"	48"		2	3	116 Lbs.	7 Cu Ft	\$ 1,244	







Model Shown
DM-6012-S-M-36



DM-6012-S-M-24	Single Face Starter	25 1/4"	12 1/8"	60"		3	4			\$ 1,863	
DM-6012-A-M-24	Single Face Adder	24 1/4"	12 1/8"	60"		3	4			\$ 1,538	
DM-6012-S-M-30	Single Face Starter	31 1/4"	12 1/8"	60"		3	4			\$ 1,863	
DM-6012-A-M-30	Single Face Adder	30 1/4"	12 1/8"	60"		3	4			\$ 1,538	
DM-6012-S-M-36	Single Face Starter	37 1/4"	12 1/8"	60"		3	4	176 Lbs.	10 Cu Ft	\$ 1,706	
DM-6012-A-M-36	Single Face Adder	36 1/4"	12 1/8"	60"		3	4	155 Lbs.	9 Cu Ft	\$ 1,381	



Model Shown
DM-7212-S-M-36

DM-7212-S-M-24	Single Face Starter	25 1/4"	12 1/8"	72"		4	5			\$ 2,106	
DM-7212-A-M-24	Single Face Adder	24 1/4"	12 1/8"	72"		4	5			\$ 1,781	
DM-7212-S-M-30	Single Face Starter	31 1/4"	12 1/8"	72"		4	5			\$ 2,106	
DM-7212-A-M-30	Single Face Adder	30 1/4"	12 1/8"	72"		4	5			\$ 1,781	
DM-7212-S-M-36	Single Face Starter	37 1/4"	12 1/8"	72"		4	5	206 Lbs.	11 Cu Ft	\$ 1,956	
DM-7212-A-M-36	Single Face Adder	36 1/4"	12 1/8"	72"		4	5	184 Lbs.	10 Cu Ft	\$ 1,619	

	MODEL NUMBER	PRODUCT	WIDTH	DEPTH	HEIGHT	SHELF DEPTH	# OF SHELVES	# OF OPENINGS	WEIGHT	VOLUME	LIST PRICE	DESCRIPTION
 <p>Model Shown DM-3624-S-DM-36</p>	DM-3624-S-M-24	Single Face Starter	25 1/4"	23 1/2"	36"		2	4			\$ 2,569	End, Mid, Top and Base Panels to be constructed from 1" thick 11-ply solid core, veneered 2 sides. Vertical, top and bottom edges banded with 1/4" external hardwood edging, edges to be eased. Front Edge: 3/4" thick x 2 1/2" high fascia - tongue and grooved to top.
	DM-3624-A-M-24	Single Face Adder	24 1/4"	23 1/2"	36"		2	4			\$ 2,000	
	DM-3624-S-M-30	Single Face Starter	31 1/4"	23 1/2"	36"		2	4			\$ 2,569	
	DM-3624-A-M-30	Single Face Adder	30 1/4"	23 1/2"	36"		2	4			\$ 2,000	
	DM-3624-S-M-36	Single Face Starter	37 1/4"	23 1/2"	36"		2	4	170 Lbs.	12 Cu Ft	\$ 2,331	
	DM-3624-A-M-36	Single Face Adder	36 1/4"	23 1/2"	36"		2	4	148 Lbs.	11 Cu Ft	\$ 1,769	
 <p>Model Shown DM-4224-S-DM-36</p>	DM-4224-S-M-24	Single Face Starter	25 1/4"	23 1/2"	42"		4	6			\$ 3,044	
	DM-4224-A-M-24	Single Face Adder	24 1/4"	23 1/2"	42"		4	6			\$ 2,488	
	DM-4224-S-M-30	Single Face Starter	31 1/4"	23 1/2"	42"		4	6			\$ 3,044	
	DM-4224-A-M-30	Single Face Adder	30 1/4"	23 1/2"	42"		4	6			\$ 2,488	
	DM-4224-S-M-36	Single Face Starter	37 1/4"	23 1/2"	42"		4	6	180 Lbs.	13 Cu Ft	\$ 2,813	
	DM-4224-A-M-36	Single Face Adder	36 1/4"	23 1/2"	42"		4	6	158 Lbs.	12 Cu Ft	\$ 2,256	
	DM-4824-S-M-24	Single Face Starter	25 1/4"	23 1/2"	48"		4	6			\$ 3,194	
	DM-4824-A-M-24	Single Face Adder	24 1/4"	23 1/2"	48"		4	6			\$ 2,613	
	DM-4824-S-M-30	Single Face Starter	31 1/4"	23 1/2"	48"		4	6			\$ 3,194	
	DM-4824-A-M-30	Single Face Adder	30 1/4"	23 1/2"	48"		4	6			\$ 2,613	
	DM-4824-S-M-36	Single Face Starter	37 1/4"	23 1/2"	48"		4	6	245 Lbs.	14 Cu Ft	\$ 2,956	
	DM-4824-A-M-36	Single Face Adder	36 1/4"	23 1/2"	48"		4	6	216 Lbs.	13 Cu Ft	\$ 2,363	
 <p>Model Shown DM-6024-S-DM-36</p>	DM-6024-S-M-24	Single Face Starter	25 1/4"	23 1/2"	60"		6	8			\$ 3,444	
	DM-6024-A-M-24	Single Face Adder	24 1/4"	23 1/2"	60"		6	8			\$ 2,875	
	DM-6024-S-M-30	Single Face Starter	31 1/4"	23 1/2"	60"		6	8			\$ 3,444	
	DM-6024-A-M-30	Single Face Adder	30 1/4"	23 1/2"	60"		6	8			\$ 2,875	
	DM-6024-S-M-36	Single Face Starter	37 1/4"	23 1/2"	60"		6	8	320 Lbs.	16 Cu Ft	\$ 3,206	
	DM-6024-A-M-36	Single Face Adder	36 1/4"	23 1/2"	60"		6	8	284 Lbs.	15 Cu Ft	\$ 2,644	
 <p>Model Shown DM-7224-S-DM-36</p>	DM-7224-S-M-24	Single Face Starter	25 1/4"	23 1/2"	72"		8	10			\$ 3,919	
	DM-7224-A-M-24	Single Face Adder	24 1/4"	23 1/2"	72"		8	10			\$ 3,344	
	DM-7224-S-M-30	Single Face Starter	31 1/4"	23 1/2"	72"		8	10			\$ 3,919	
	DM-7224-A-M-30	Single Face Adder	30 1/4"	23 1/2"	72"		8	10			\$ 3,344	
	DM-7224-S-M-36	Single Face Starter	37 1/4"	23 1/2"	72"		8	10	378 Lbs.	18 Cu Ft	\$ 3,681	
	DM-7224-A-M-36	Single Face Adder	36 1/4"	23 1/2"	72"		8	10	336 Lbs.	17 Cu Ft	\$ 3,119	



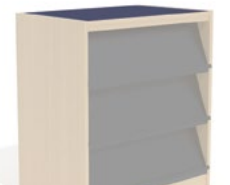
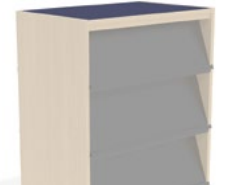

	MODEL NUMBER	PRODUCT	WIDTH	DEPTH	HEIGHT	SHELF DEPTH	# OF SHELVES	# OF OPENINGS	WEIGHT	VOLUME	LIST PRICE	DESCRIPTION
 <p>Model Shown DM-3612-S-DM-36-IPT</p>	DM-3612-S-M-24-IPT	Single Face Starter	25 1/4"	12 1/8"	36"		1	2			\$ 1,506	End, Mid, Top and Base Panels to be constructed from 1" thick 11-ply solid core, veneered 2 sides. Vertical, top and bottom edges banded with 1/4" external hardwood edging, edges to be eased. Front Edge: 3/4" thick x 2 1/2" high fascia - tongue and grooved to top.
	DM-3612-A-M-24-IPT	Single Face Adder	24 1/4"	12 1/8"	36"		1	2			\$ 1,175	
	DM-3612-S-M-30-IPT	Single Face Starter	31 1/4"	12 1/8"	36"		1	2			\$ 1,506	
	DM-3612-A-M-30-IPT	Single Face Adder	30 1/4"	12 1/8"	36"		1	2			\$ 1,175	
	DM-3612-S-M-36-IPT	Single Face Starter	37 1/4"	12 1/8"	36"		1	2	80.5 Lbs.	6 Cu Ft	\$ 1,350	
	DM-3612-A-M-36-IPT	Single Face Adder	36 1/4"	12 1/8"	36"		1	2	77.1 Lbs.	6 Cu Ft	\$ 1,019	
 <p>Model Shown DM-4212-S-DM-36-IPT</p>	DM-4212-S-M-24-IPT	Single Face Starter	25 1/4"	12 1/8"	42"		2	3			\$ 1,743	
	DM-4212-A-M-24-IPT	Single Face Adder	24 1/4"	12 1/8"	42"		2	3			\$ 1,419	
	DM-4212-S-M-30-IPT	Single Face Starter	31 1/4"	12 1/8"	42"		2	3			\$ 1,744	
	DM-4212-A-M-30-IPT	Single Face Adder	30 1/4"	12 1/8"	42"		2	3			\$ 1,419	
	DM-4212-S-M-36-IPT	Single Face Starter	37 1/4"	12 1/8"	42"		2	3	82.5 Lbs.	7 Cu Ft	\$ 1,594	
	DM-4212-A-M-36-IPT	Single Face Adder	36 1/4"	12 1/8"	42"		2	3	80 Lbs.	7 Cu Ft	\$ 1,263	
	DM-4812-S-M-24-IPT	Single Face Starter	25 1/4"	12 1/8"	48"		2	3			\$ 1,844	
	DM-4812-A-M-24-IPT	Single Face Adder	24 1/4"	12 1/8"	48"		2	3			\$ 1,488	
	DM-4812-S-M-30-IPT	Single Face Starter	31 1/4"	12 1/8"	48"		2	3			\$ 1,844	
	DM-4812-A-M-30-IPT	Single Face Adder	30 1/4"	12 1/8"	48"		2	3			\$ 1,488	
	DM-4812-S-M-36-IPT	Single Face Starter	37 1/4"	12 1/8"	48"		2	3	128 Lbs.	7 Cu Ft	\$ 1,669	
	DM-4812-A-M-36-IPT	Single Face Adder	36 1/4"	12 1/8"	48"		2	3	116 Lbs.	7 Cu Ft	\$ 1,325	
 <p>Model Shown DM-6012-S-DM-36-IPT</p>	DM-6012-S-M-24-IPT	Single Face Starter	25 1/4"	12 1/8"	60"		3	4			\$ 1,944	
	DM-6012-A-M-24-IPT	Single Face Adder	24 1/4"	12 1/8"	60"		3	4			\$ 1,619	
	DM-6012-S-M-30-IPT	Single Face Starter	31 1/4"	12 1/8"	60"		3	4			\$ 1,944	
	DM-6012-A-M-30-IPT	Single Face Adder	30 1/4"	12 1/8"	60"		3	4			\$ 1,619	
	DM-6012-S-M-36-IPT	Single Face Starter	37 1/4"	12 1/8"	60"		3	4	176 Lbs.	10 Cu Ft	\$ 1,781	
	DM-6012-A-M-36-IPT	Single Face Adder	36 1/4"	12 1/8"	60"		3	4	155 Lbs.	9 Cu Ft	\$ 1,456	

	MODEL NUMBER	PRODUCT	WIDTH	DEPTH	HEIGHT	SHELF DEPTH	# OF SHELVES	# OF OPENINGS	WEIGHT	VOLUME	LIST PRICE	DESCRIPTION
 <p>Model Shown DM-3612-S-DM-36-IPT</p>	DM-3624-S-M-24-IPT	Single Face Starter	25 1/4"	23 1/2"	36"		2	4			\$ 2,706	End, Mid, Top and Base Panels to be constructed from 1" thick 11-ply solid core, veneered 2 sides. Vertical, top and bottom edges banded with 1/4" external hardwood edging, edges to be eased. Front Edge: 3/4" thick x 2 1/2" high fascia - tongue and grooved to top.
	DM-3624-A-M-24-IPT	Single Face Adder	24 1/4"	23 1/2"	36"		2	4			\$ 2,156	
	DM-3624-S-M-30-IPT	Single Face Starter	31 1/4"	23 1/2"	36"		2	4			\$ 2,706	
	DM-3624-A-M-30-IPT	Single Face Adder	30 1/4"	23 1/2"	36"		2	4			\$ 2,156	
	DM-3624-S-M-36-IPT	Single Face Starter	37 1/4"	23 1/2"	36"		2	4	170 Lbs.	12 Cu Ft	\$ 2,488	
	DM-3624-A-M-36-IPT	Single Face Adder	36 1/4"	23 1/2"	36"		2	4	148 Lbs.	11 Cu Ft	\$ 1,919	
 <p>Model Shown DM-4212-S-DM-36-IPT</p>	DM-4224-S-M-24-IPT	Single Face Starter	25 1/4"	23 1/2"	42"		4	6			\$ 3,200	
	DM-4224-A-M-24-IPT	Single Face Adder	24 1/4"	23 1/2"	42"		4	6			\$ 2,644	
	DM-4224-S-M-30-IPT	Single Face Starter	31 1/4"	23 1/2"	42"		4	6			\$ 3,200	
	DM-4224-A-M-30-IPT	Single Face Adder	30 1/4"	23 1/2"	42"		4	6			\$ 2,644	
	DM-4224-S-M-36-IPT	Single Face Starter	37 1/4"	23 1/2"	42"		4	6	180 Lbs.	13 Cu Ft	\$ 2,969	
	DM-4224-A-M-36-IPT	Single Face Adder	36 1/4"	23 1/2"	42"		4	6	158 Lbs.	12 Cu Ft	\$ 2,406	
	DM-4824-S-M-24-IPT	Single Face Starter	25 1/4"	23 1/2"	48"		4	6			\$ 3,350	
	DM-4824-A-M-24-IPT	Single Face Adder	24 1/4"	23 1/2"	48"		4	6			\$ 2,769	
	DM-4824-S-M-30-IPT	Single Face Starter	31 1/4"	23 1/2"	48"		4	6			\$ 3,350	
	DM-4824-A-M-30-IPT	Single Face Adder	30 1/4"	23 1/2"	48"		4	6			\$ 2,769	
	DM-4824-S-M-36-IPT	Single Face Starter	37 1/4"	23 1/2"	48"		4	6	245 Lbs.	14 Cu Ft	\$ 3,138	
	DM-4824-A-M-36-IPT	Single Face Adder	36 1/4"	23 1/2"	48"		4	6	216 Lbs.	13 Cu Ft	\$ 2,519	
 <p>Model Shown DM-6012-S-DM-36-IPT</p>	DM-6024-S-M-24-IPT	Single Face Starter	25 1/4"	23 1/2"	60"		6	8			\$ 3,469	
	DM-6024-A-M-24-IPT	Single Face Adder	24 1/4"	23 1/2"	60"		6	8			\$ 3,031	
	DM-6024-S-M-30-IPT	Single Face Starter	31 1/4"	23 1/2"	60"		6	8			\$ 3,469	
	DM-6024-A-M-30-IPT	Single Face Adder	30 1/4"	23 1/2"	60"		6	8			\$ 3,031	
	DM-6024-S-M-36-IPT	Single Face Starter	37 1/4"	23 1/2"	60"		6	8	320 Lbs.	16 Cu Ft	\$ 3,394	
	DM-6024-A-M-36-IPT	Single Face Adder	36 1/4"	23 1/2"	60"		6	8	284 Lbs.	15 Cu Ft	\$ 2,800	

SHELVING

MODEL NUMBER	PRODUCT	WIDTH	DEPTH	HEIGHT	WEIGHT	VOLUME	LIST PRICE	DESCRIPTION	
 <p>Model Shown S-BA7212E</p>	S-BA3010E	Bolt Assembly	1"	9 ⁷ / ₈ "	30"		\$ 425		
	S-BA3610E	Single Face End Panels	1"	9 ⁷ / ₈ "	36"	7 Lbs.	0.3 Cu Ft	\$ 444	
	S-BA4210E		1"	9 ⁷ / ₈ "	42"	8 Lbs.	0.3 Cu Ft	\$ 456	
	S-BA4810E		1"	9 ⁷ / ₈ "	48"	9 Lbs.	0.3 Cu Ft	\$ 469	
	S-BA6010E		1"	9 ⁷ / ₈ "	60"	12 Lbs.	0.4 Cu Ft	\$ 494	
	S-BA7210E		1"	9 ⁷ / ₈ "	72"	14 Lbs.	0.5 Cu Ft	\$ 513	
	S-BA8210E		1"	9 ⁷ / ₈ "	82"	16 Lbs.	0.6 Cu Ft	\$ 538	
	S-BA9610E		1"	9 ⁷ / ₈ "	96"	19 Lbs.	0.7 Cu Ft	\$ 563	
	S-BA3012E	Bolt Assembly	1"	11 ⁷ / ₈ "	30"			\$ 556	
	S-BA3612E	Single Face End Panels	1"	11 ⁷ / ₈ "	36"	7 Lbs.	0.3 Cu Ft	\$ 588	
S-BA4212E		1"	11 ⁷ / ₈ "	42"	8 Lbs.	0.3 Cu Ft	\$ 600		
S-BA4812E		1"	11 ⁷ / ₈ "	48"	9 Lbs.	0.3 Cu Ft	\$ 500		
S-BA6012E		1"	11 ⁷ / ₈ "	60"	12 Lbs.	0.4 Cu Ft	\$ 525		
S-BA7212E		1"	11 ⁷ / ₈ "	72"	14 Lbs.	0.5 Cu Ft	\$ 550		
S-BA8212E		1"	11 ⁷ / ₈ "	82"	16 Lbs.	0.6 Cu Ft	\$ 575		
S-BA9612E		1"	11 ⁷ / ₈ "	96"	19 Lbs.	0.7 Cu Ft	\$ 600		
S-BA3014E	Bolt Assembly	1"	14 ³ / ₈ "	30"			\$ 594		
S-BA3614E	Single Face End Panels	1"	14 ³ / ₈ "	36"	7 Lbs.	0.3 Cu Ft	\$ 625		
S-BA4214E		1"	14 ³ / ₈ "	42"	8 Lbs.	0.3 Cu Ft	\$ 638		
S-BA4814E		1"	14 ³ / ₈ "	48"	9 Lbs.	0.3 Cu Ft	\$ 525		
S-BA6014E		1"	14 ³ / ₈ "	60"	12 Lbs.	0.4 Cu Ft	\$ 550		
S-BA7214E		1"	14 ³ / ₈ "	72"	14 Lbs.	0.5 Cu Ft	\$ 575		
S-BA8214E		1"	14 ³ / ₈ "	82"	16 Lbs.	0.6 Cu Ft	\$ 600		
S-BA9614E		1"	14 ³ / ₈ "	96"	19 Lbs.	0.7 Cu Ft	\$ 625		
S-BA3020E	Bolt Assembly	1"	19 ¹ / ₂ "	30"			\$ 731		
S-BA3620E	Double Face End Panels	1"	19 ¹ / ₂ "	36"	14 Lbs.	0.6 Cu Ft	\$ 769		
S-BA4220E		1"	19 ¹ / ₂ "	42"	15 Lbs.	0.6 Cu Ft	\$ 788		
S-BA4820E		1"	19 ¹ / ₂ "	48"	18 Lbs.	0.7 Cu Ft	\$ 813		
S-BA6020E		1"	19 ¹ / ₂ "	60"	24 Lbs.	0.8 Cu Ft	\$ 863		
S-BA7220E		1"	19 ¹ / ₂ "	72"	28 Lbs.	1 Cu Ft	\$ 906		
S-BA8220E		1"	19 ¹ / ₂ "	82"	32 Lbs.	1.2 Cu Ft	\$ 956		
S-BA9620E		1"	19 ¹ / ₂ "	96"	38 Lbs.	1.4 Cu Ft	\$ 988		
S-BA3024E	Bolt Assembly	1"	23 ¹ / ₂ "	30"			\$ 756		
S-BA3624E	Double Face End Panels	1"	23 ¹ / ₂ "	36"	14 Lbs.	0.6 Cu Ft	\$ 788		
S-BA4224E		1"	23 ¹ / ₂ "	42"	15 Lbs.	0.6 Cu Ft	\$ 813		
S-BA4824E		1"	23 ¹ / ₂ "	48"	18 Lbs.	0.7 Cu Ft	\$ 838		
S-BA6024E		1"	23 ¹ / ₂ "	60"	24 Lbs.	0.8 Cu Ft	\$ 881		
S-BA7224E		1"	23 ¹ / ₂ "	72"	28 Lbs.	1 Cu Ft	\$ 931		
S-BA8224E		1"	23 ¹ / ₂ "	82"	32 Lbs.	1.2 Cu Ft	\$ 981		
S-BA9624E		1"	23 ¹ / ₂ "	96"	38 Lbs.	1.4 Cu Ft	\$ 1,025		
S-BA3028E	Bolt Assembly	1"	28 ¹ / ₂ "	30"			\$ 825		
S-BA3628E	Double Face End Panels	1"	28 ¹ / ₂ "	36"	14 Lbs.	0.6 Cu Ft	\$ 863		
S-BA4228E		1"	28 ¹ / ₂ "	42"	15 Lbs.	0.6 Cu Ft	\$ 888		
S-BA4828E		1"	28 ¹ / ₂ "	48"	18 Lbs.	0.7 Cu Ft	\$ 931		
S-BA6028E		1"	28 ¹ / ₂ "	60"	24 Lbs.	0.8 Cu Ft	\$ 994		
S-BA7228E		1"	28 ¹ / ₂ "	72"	28 Lbs.	1 Cu Ft	\$ 1,075		
S-BA8228E		1"	28 ¹ / ₂ "	82"	32 Lbs.	1.2 Cu Ft	\$ 1,144		
S-BA9628E		1"	28 ¹ / ₂ "	96"	38 Lbs.	1.4 Cu Ft	\$ 1,356		

MODEL NUMBER	PRODUCT	WIDTH	DEPTH	HEIGHT	WEIGHT	VOLUME	LIST PRICE	DESCRIPTION	
 <p>Model Shown S-BA7212M</p>	S-BA3010M	Bolt Assembly	1"	9 ⁷ / ₈ "	30"		\$ 444		
	S-BA3610M	Single Face Mid Panels	1"	9 ⁷ / ₈ "	36"	7 Lbs.	0.3 Cu Ft	\$ 469	
	S-BA4210M		1"	9 ⁷ / ₈ "	42"	8 Lbs.	0.3 Cu Ft	\$ 481	
	S-BA4810M		1"	9 ⁷ / ₈ "	48"	9 Lbs.	0.3 Cu Ft	\$ 494	
	S-BA6010M		1"	9 ⁷ / ₈ "	60"	12 Lbs.	0.4 Cu Ft	\$ 513	
	S-BA7210M		1"	9 ⁷ / ₈ "	72"	14 Lbs.	0.5 Cu Ft	\$ 538	
	S-BA8210M		1"	9 ⁷ / ₈ "	82"	16 Lbs.	0.6 Cu Ft	\$ 563	
	S-BA9610M		1"	9 ⁷ / ₈ "	96"	19 Lbs.	0.7 Cu Ft	\$ 588	
	S-BA3012M	Bolt Assembly	1"	11 ⁷ / ₈ "	30"			\$ 456	
	S-BA3612M	Single Face Mid Panels	1"	11 ⁷ / ₈ "	36"	7 Lbs.	0.3 Cu Ft	\$ 481	
S-BA4212M		1"	11 ⁷ / ₈ "	42"	8 Lbs.	0.3 Cu Ft	\$ 494		
S-BA4812M		1"	11 ⁷ / ₈ "	48"	9 Lbs.	0.3 Cu Ft	\$ 500		
S-BA6012M		1"	11 ⁷ / ₈ "	60"	12 Lbs.	0.4 Cu Ft	\$ 525		
S-BA7212M		1"	11 ⁷ / ₈ "	72"	14 Lbs.	0.5 Cu Ft	\$ 550		
S-BA8212M		1"	11 ⁷ / ₈ "	82"	16 Lbs.	0.6 Cu Ft	\$ 575		
S-BA9612M		1"	11 ⁷ / ₈ "	96"	19 Lbs.	0.7 Cu Ft	\$ 600		
S-BA3014M	Bolt Assembly	1"	14 ³ / ₈ "	30"			\$ 481		
S-BA3614M	Single Face Mid Panels	1"	14 ³ / ₈ "	36"	7 Lbs.	0.3 Cu Ft	\$ 500		
S-BA4214M		1"	14 ³ / ₈ "	42"	8 Lbs.	0.3 Cu Ft	\$ 544		
S-BA4814M		1"	14 ³ / ₈ "	48"	9 Lbs.	0.3 Cu Ft	\$ 525		
S-BA6014M		1"	14 ³ / ₈ "	60"	12 Lbs.	0.4 Cu Ft	\$ 550		
S-BA7214M		1"	14 ³ / ₈ "	72"	14 Lbs.	0.5 Cu Ft	\$ 600		
S-BA8214M		1"	14 ³ / ₈ "	82"	16 Lbs.	0.6 Cu Ft	\$ 625		
S-BA9614M		1"	14 ³ / ₈ "	96"	19 Lbs.	0.7 Cu Ft	\$ 644		
S-BA3020M	Bolt Assembly	1"	19 ¹ / ₂ "	30"			\$ 756		
S-BA3620M	Double Face Mid Panels	1"	19 ¹ / ₂ "	36"	14 Lbs.	0.6 Cu Ft	\$ 788		
S-BA4220M		1"	19 ¹ / ₂ "	42"	15 Lbs.	0.6 Cu Ft	\$ 813		
S-BA4820M		1"	19 ¹ / ₂ "	48"	18 Lbs.	0.7 Cu Ft	\$ 838		
S-BA6020M		1"	19 ¹ / ₂ "	60"	24 Lbs.	0.8 Cu Ft	\$ 881		
S-BA7220M		1"	19 ¹ / ₂ "	72"	28 Lbs.	1 Cu Ft	\$ 931		
S-BA8220M		1"	19 ¹ / ₂ "	82"	32 Lbs.	1.2 Cu Ft	\$ 981		
S-BA9620M		1"	19 ¹ / ₂ "	96"	38 Lbs.	1.4 Cu Ft	\$ 1,025		
S-BA3024M	Bolt Assembly	1"	23 ¹ / ₂ "	30"			\$ 775		
S-BA3624M	Double Face Mid Panels	1"	23 ¹ / ₂ "	36"	14 Lbs.	0.6 Cu Ft	\$ 813		
S-BA4224M		1"	23 ¹ / ₂ "	42"	15 Lbs.	0.6 Cu Ft	\$ 838		
S-BA4824M		1"	23 ¹ / ₂ "	48"	18 Lbs.	0.7 Cu Ft	\$ 863		
S-BA6024M		1"	23 ¹ / ₂ "	60"	24 Lbs.	0.8 Cu Ft	\$ 906		
S-BA7224M		1"	23 ¹ / ₂ "	72"	28 Lbs.	1 Cu Ft	\$ 956		
S-BA8224M		1"	23 ¹ / ₂ "	82"	32 Lbs.	1.2 Cu Ft	\$ 1,000		
S-BA9624M		1"	23 ¹ / ₂ "	96"	38 Lbs.	1.4 Cu Ft	\$ 1,050		
S-BA3028M	Bolt Assembly	1"	28 ¹ / ₂ "	30"			\$ 844		
S-BA3628M	Double Face Mid Panels	1"	28 ¹ / ₂ "	36"	14 Lbs.	0.6 Cu Ft	\$ 881		
S-BA4228M		1"	28 ¹ / ₂ "	42"	15 Lbs.	0.6 Cu Ft	\$ 913		
S-BA4828M		1"	28 ¹ / ₂ "	48"	18 Lbs.	0.7 Cu Ft	\$ 956		
S-BA6028M		1"	28 ¹ / ₂ "	60"	24 Lbs.	0.8 Cu Ft	\$ 1,025		
S-BA7228M		1"	28 ¹ / ₂ "	72"	28 Lbs.	1 Cu Ft	\$ 1,100		
S-BA8228M		1"	28 ¹ / ₂ "	82"	32 Lbs.	1.2 Cu Ft	\$ 1,169		
S-BA9628M		1"	28 ¹ / ₂ "	96"	38 Lbs.	1.4 Cu Ft	\$ 1,244		

	MODEL NUMBER	PRODUCT	WIDTH	DEPTH	HEIGHT	WEIGHT	VOLUME	LIST PRICE	DESCRIPTION
	S-BAT1024	Bolt Assembly Single Face Top Shelf	23 1/4"	9 3/4"	2 1/2"	7 Lbs.	0.3 Cu Ft	\$ 431	
	S-BAT1224		23 1/4"	11 3/4"	2 1/2"			\$ 444	
	S-BAT1424		23 1/4"	14 1/4"	2 1/2"			\$ 456	
	S-BAT1030		29 1/4"	9 3/4"	2 1/2"			\$ 431	
	S-BAT1230		29 1/4"	11 3/4"	2 1/2"			\$ 444	
	S-BAT1430		29 1/4"	14 1/4"	2 1/2"			\$ 456	
	S-BAT1036		35 1/4"	9 3/4"	2 1/2"	7 Lbs	0.8 Cu Ft	\$ 363	
	S-BAT1236		35 1/4"	11 3/4"	2 1/2"	9 Lbs	0.8 Cu Ft	\$ 375	
	S-BAT1436		35 1/4"	14 1/4"	2 1/2"	10 Lbs	0.8 Cu Ft	\$ 388	
	S-BAT2024	Bolt Assembly Double Face Top Shelf	23 1/4"	9 3/4"	2 1/2"			\$ 619	
	S-BAT2424		23 1/4"	11 3/4"	2 1/2"			\$ 644	
	S-BAT2824		23 1/4"	14 1/4"	2 1/2"			\$ 675	
	S-BAT2030		29 1/4"	9 3/4"	2 1/2"			\$ 619	
	S-BAT2430		29 1/4"	11 3/4"	2 1/2"			\$ 644	
	S-BAT2830		29 1/4"	14 1/4"	2 1/2"			\$ 675	
	S-BAT2036		35 1/4"	9 3/4"	2 1/2"	14 Lbs	1.5 Cu Ft	\$ 513	
	S-BAT2436		35 1/4"	11 3/4"	2 1/2"	16 Lbs	1.5 Cu Ft	\$ 538	
	S-BAT2836		35 1/4"	14 1/4"	2 1/2"	18 Lbs	1.5 Cu Ft	\$ 575	
	S-BAB1024	Bolt Assembly Single Face Bottom Shelf	23 1/4"	9 3/4"	2 1/2"			\$ 450	
	S-BAB1224		23 1/4"	11 3/4"	2 1/2"			\$ 463	
	S-BAB1424		23 1/4"	14 1/4"	2 1/2"			\$ 475	
	S-BAB1030		29 1/4"	9 3/4"	2 1/2"			\$ 450	
	S-BAB1230		29 1/4"	11 3/4"	2 1/2"			\$ 463	
	S-BAB1430		29 1/4"	14 1/4"	2 1/2"			\$ 475	
	S-BAB1036		35 1/4"	9 3/4"	2 1/2"	7 Lbs	0.8 Cu Ft	\$ 375	
	S-BAB1236		35 1/4"	11 3/4"	2 1/2"	9 Lbs	0.8 Cu Ft	\$ 394	
	S-BAB1436		35 1/4"	14 1/4"	2 1/2"	10 Lbs	0.8 Cu Ft	\$ 406	
	S-BAB2024	Bolt Assembly Double Face Bottom Shelf	23 1/4"	9 3/4"	2 1/2"			\$ 650	
	S-BAB2424		23 1/4"	11 3/4"	2 1/2"			\$ 675	
	S-BAB2824		23 1/4"	14 1/4"	2 1/2"			\$ 706	
	S-BAB2030		29 1/4"	9 3/4"	2 1/2"			\$ 650	
	S-BAB2430		29 1/4"	11 3/4"	2 1/2"			\$ 675	
	S-BAB2830		29 1/4"	14 1/4"	2 1/2"			\$ 731	
	S-BAB2036		35 1/4"	9 3/4"	2 1/2"	14 Lbs	1.5 Cu Ft	\$ 538	
	S-BAB2436		35 1/4"	11 3/4"	2 1/2"	16 Lbs	1.5 Cu Ft	\$ 563	
	S-BAB2836		35 1/4"	14 1/4"	2 1/2"	18 Lbs	1.5 Cu Ft	\$ 600	

SHELVING

MODEL NUMBER	PRODUCT	WIDTH	DEPTH	HEIGHT	WEIGHT	VOLUME	LIST PRICE	DESCRIPTION
S-PB30S-24 S-PB30S-30 S-PB30S-36	Printed Backs - Single Face	24"		30"			\$ 63	
		30"		30"			\$ 63	
		36"		30"			\$ 69	
S-PB36S-24 S-PB36S-30 S-PB36S-36		24"		36"	9 Lbs.	0.2 Cu Ft	\$ 63	
		30"		36"			\$ 63	
		36"		36"			\$ 69	
S-PB42S-24 S-PB42S-30 S-PB42S-36		24"		42"			\$ 63	
		30"		42"			\$ 63	
		36"		42"	9 Lbs.	0.2 Cu Ft	\$ 69	
S-PB48S-24 S-PB48S-30 S-PB48S-36		24"		48"			\$ 63	
		30"		48"			\$ 63	
		36"		48"	12 Lbs.	0.3 Cu Ft	\$ 69	
S-PB60S-24 S-PB60S-30 S-PB60S-36		24"		60"			\$ 75	
		30"		60"			\$ 88	
		36"		60"	15 Lbs.	0.3 Cu Ft	\$ 88	
S-PB72S-24 S-PB72S-30 S-PB72S-36		24"		72"			\$ 106	
		30"		72"			\$ 106	
		36"		72"	18 Lbs.	0.4 Cu Ft	\$ 106	
S-PB84S-24 S-PB84S-30 S-PB84S-36		24"		82"			\$ 106	
		30"		82"			\$ 106	
		36"		82"	21 Lbs.	0.4 Cu Ft	\$ 106	
S-PB96S-24 S-PB96S-30 S-PB96S-36		24"		96"			\$ 106	
		30"		96"			\$ 106	
		36"		96"	24 Lbs.	0.5 Cu Ft	\$ 106	



Model Shown
S-PB72D-24



SHELVING

MODEL NUMBER	PRODUCT	WIDTH	DEPTH	HEIGHT	WEIGHT	VOLUME	LIST PRICE	DESCRIPTION
S-PB30D-24 S-PB30D-30 S-PB30D-36	Printed Backs - Double Face	24"		30"			\$ 75	
		30"		30"			\$ 75	
		36"		30"			\$ 75	
S-PB36D-24 S-PB36D-30 S-PB36D-36		24"		36"	9 Lbs.	0.2 Cu Ft	\$ 75	
		30"		36"			\$ 75	
		36"		36"			\$ 75	
S-PB42D-24 S-PB42D-30 S-PB42D-36		24"		42"			\$ 75	
		30"		42"			\$ 75	
		36"		42"	9 Lbs.	0.2 Cu Ft	\$ 75	
S-PB48D-24 S-PB48D-30 S-PB48D-36		24"		48"			\$ 75	
		30"		48"			\$ 75	
		36"		48"	12 Lbs.	0.3 Cu Ft	\$ 75	
S-PB60D-24 S-PB60D-30 S-PB60D-36		24"		60"			\$ 119	
		30"		60"			\$ 119	
		36"		60"	15 Lbs.	0.3 Cu Ft	\$ 119	
S-PB72D-24 S-PB72D-30 S-PB72D-36		24"		72"			\$ 119	
		30"		72"			\$ 119	
		36"		72"	18 Lbs.	0.4 Cu Ft	\$ 119	
S-PB84D-24 S-PB84D-30 S-PB84D-36		24"		82"			\$ 119	
		30"		82"			\$ 119	
		36"		82"	21 Lbs.	0.4 Cu Ft	\$ 119	
S-PB96D-24 S-PB96D-30 S-PB96D-36		24"		96"			\$ 119	
		30"		96"			\$ 119	
		36"		96"	24 Lbs.	0.5 Cu Ft	\$ 119	



Model Shown
S-PB72D-24

SHELVING

	MODEL NUMBER	PRODUCT	WIDTH	DEPTH	HEIGHT	WEIGHT	VOLUME	LIST PRICE	DESCRIPTION
 <p>Model Shown S-PLSS-3612</p>	S-PLSS-2410	Sloped Continuous Plastic	24"	9 ³ / ₄ "	7"	45 Lbs.	0.6 Cu Ft	\$ 450	Sloped Top option is only available for Shelving units with a height of 36", 42", or 48" Note: With this option the overall height of the unit will increase; 36" increases to 43" 42" increases to 49" 48" increases to 55"
	S-PLSS-2412	Laminate Top, Single Face	24"	11 ³ / ₄ "	7"			\$ 463	
	S-PLSS-2414		24"	14 ¹ / ₄ "	7"			\$ 475	
	S-PLSS-3010		30"	9 ³ / ₄ "	7"			\$ 450	
	S-PLSS-3012		30"	11 ³ / ₄ "	7"			\$ 463	
	S-PLSS-3014		30"	14 ¹ / ₄ "	7"			\$ 475	
	S-PLSS-3610		36"	9 ³ / ₄ "	7"			\$ 381	
	S-PLSS-3612		36"	11 ³ / ₄ "	7"			\$ 394	
	S-PLSS-3614		36"	14 ¹ / ₄ "	7"			\$ 400	
 <p>Model Shown S-PLSD-3624</p>	S-PLSD-2420	Sloped Continuous Plastic	24"	19 ¹ / ₄ "	7"	75 Lbs.	17 Cu Ft	\$ 613	
	S-PLSD-2424	Laminate Top, Double Face	24"	23 ¹ / ₄ "	7"			\$ 631	
	S-PLSD-2428		24"	28 ¹ / ₄ "	7"			\$ 650	
	S-PLSD-3020		30"	19 ¹ / ₄ "	7"			\$ 613	
	S-PLSD-3024		30"	23 ¹ / ₄ "	7"			\$ 631	
	S-PLSD-3028		30"	28 ¹ / ₄ "	7"			\$ 650	
	S-PLSD-3620		36"	19 ¹ / ₄ "	7"			\$ 544	
	S-PLSD-3624		36"	23 ¹ / ₄ "	7"			\$ 563	
	S-PLSD-3628		36"	28 ¹ / ₄ "	7"			\$ 575	
	S-CT36S-B	Continuous Top, Square Edge (Beta) Single Face				30 Lbs.	0.4 Cu Ft	\$ 206	Single faced tops shall receive edges on 2 short and 1 long edge. Double faced tops shall receive edges on 2 long and 2 short edges. Tops longer than 108" shall be joined together using tight joint fasteners. Suitable for shelving up to 60" high.
	S-CT36D-B	Double Face				60 Lbs.	0.7 Cu Ft	\$ 306	
	S-CT36S-R	Continuous Top, Bullnose Edge (Ronda) Single Face				30 Lbs.	0.4 Cu Ft	\$ 350	Prices are given per individual bay. Multiply the list price by the number of bay lengths required.
	S-CT36D-R	Double Face				60 Lbs.	0.7 Cu Ft	\$ 400	

SHELVING

MODEL NUMBER	PRODUCT	WIDTH	DEPTH	HEIGHT	WEIGHT	VOLUME	LIST PRICE	DESCRIPTION
	S-VB30S-24	Veneer Backs - Single Face	24"	30"			\$ 144	
	S-VB30S-30		30"	30"			\$ 144	
	S-VB30S-36		36"	30"			\$ 144	
	S-VB36S-24		24"	36"	9 Lbs.	0.2 Cu Ft	\$ 144	
	S-VB36S-30		30"	36"			\$ 144	
	S-VB36S-36		36"	36"			\$ 144	
	S-VB42S-24		24"	42"			\$ 144	
	S-VB42S-30		30"	42"			\$ 144	
	S-VB42S-36		36"	42"	9 Lbs.	0.2 Cu Ft	\$ 144	
	S-VB48S-24		24"	48"			\$ 144	
	S-VB48S-30		30"	48"			\$ 144	
	S-VB48S-36		36"	48"	12 Lbs.	0.3 Cu Ft	\$ 144	
	S-VB60S-24		24"	60"			\$ 219	
	S-VB60S-30		30"	60"			\$ 219	
	S-VB60S-36		36"	60"	15 Lbs.	0.3 Cu Ft	\$ 219	
	S-VB72S-24		24"	72"			\$ 219	
	S-VB72S-30		30"	72"			\$ 219	
	S-VB72S-36		36"	72"	18 Lbs.	0.4 Cu Ft	\$ 219	
	S-VB82S-24		24"	82"			\$ 219	
	S-VB82S-30		30"	82"			\$ 219	
	S-VB82S-36		36"	82"	21 Lbs.	0.4 Cu Ft	\$ 219	
	S-VB96S-24		24"	96"			\$ 219	
	S-VB96S-30		30"	96"			\$ 219	
	S-VB96S-36		36"	96"	24 Lbs.	0.5 Cu Ft	\$ 219	

Model Shown
S-VB72D-24

MODEL NUMBER	PRODUCT	WIDTH	DEPTH	HEIGHT	WEIGHT	VOLUME	LIST PRICE	DESCRIPTION
	S-VB30D-24	Veneer Backs - Double Face	24"	30"			\$ 219	
	S-VB30D-30		30"	30"			\$ 219	
	S-VB30D-36		36"	30"			\$ 219	
	S-VB36D-24		24"	36"	9 Lbs.	0.2 Cu Ft	\$ 219	
	S-VB36D-30		30"	36"			\$ 219	
	S-VB36D-36		36"	36"			\$ 219	
	S-VB42D-24		24"	42"			\$ 219	
	S-VB42D-30		30"	42"			\$ 219	
	S-VB42D-36		36"	42"	9 Lbs.	0.2 Cu Ft	\$ 219	
	S-VB48D-24		24"	48"			\$ 219	
	S-VB48D-30		30"	48"			\$ 219	
	S-VB48D-36		36"	48"	12 Lbs.	0.3 Cu Ft	\$ 219	
	S-VB60D-24		24"	60"			\$ 319	
	S-VB60D-30		30"	60"			\$ 319	
	S-VB60D-36		36"	60"	15 Lbs.	0.3 Cu Ft	\$ 319	
	S-VB72D-24		24"	72"			\$ 319	
	S-VB72D-30		30"	72"			\$ 319	
	S-VB72D-36		36"	72"	18 Lbs.	0.4 Cu Ft	\$ 319	
	S-VB82D-24		24"	82"			\$ 319	
	S-VB82D-30		30"	82"			\$ 319	
	S-VB82D-36		36"	82"	21 Lbs.	0.4 Cu Ft	\$ 319	
	S-VB96D-24		24"	96"			\$ 319	
	S-VB96D-30		30"	96"			\$ 319	
	S-VB96D-36		36"	96"	24 Lbs.	0.5 Cu Ft	\$ 319	

Model Shown
S-VB72D-24

MODEL NUMBER	PRODUCT	WIDTH	DEPTH	HEIGHT	WEIGHT	VOLUME	LIST PRICE	DESCRIPTION
	S-FB-V-30-24	Finished Back Veneer Option	24"	30"			\$ 456	
	S-FB-V-30-30		30"	30"			\$ 456	
	S-FB-V-30-36		36"	30"			\$ 456	
	S-FB-V-36-24		24"	36"	9 Lbs.	0.2 Cu Ft	\$ 456	
	S-FB-V-36-30		30"	36"			\$ 456	
	S-FB-V-36-36		36"	36"			\$ 456	
	S-FB-V-42-24		24"	42"			\$ 456	
	S-FB-V-42-30		30"	42"			\$ 456	
	S-FB-V-42-36		36"	42"	9 Lbs.	0.2 Cu Ft	\$ 456	
	S-FB-V-48-24		24"	48"			\$ 456	
	S-FB-V-48-30		30"	48"			\$ 456	
	S-FB-V-48-36		36"	48"	12 Lbs.	0.3 Cu Ft	\$ 456	
	S-FB-V-60-24		24"	60"			\$ 575	
	S-FB-V-60-30		30"	60"			\$ 575	
	S-FB-V-60-36		36"	60"	15 Lbs.	0.3 Cu Ft	\$ 575	
	S-FB-V-72-24		24"	72"			\$ 575	
	S-FB-V-72-30		30"	72"			\$ 575	
	S-FB-V-72-36		36"	72"	18 Lbs.	0.4 Cu Ft	\$ 575	
	S-FB-V-82-24		24"	82"			\$ 575	
	S-FB-V-82-30		30"	82"			\$ 575	
	S-FB-V-82-36		36"	82"	21 Lbs.	0.4 Cu Ft	\$ 575	
	S-FB-V-96-24		24"	96"			\$ 575	
	S-FB-V-96-30		30"	96"			\$ 575	
	S-FB-V-96-36		36"	96"	24 Lbs.	0.5 Cu Ft	\$ 575	

Model Shown
S-FB-V-72-24

MODEL NUMBER	PRODUCT	WIDTH	DEPTH	HEIGHT	WEIGHT	VOLUME	LIST PRICE	DESCRIPTION
	S-FB-C-30-24	24"		30"			\$ 669	
	S-FB-C-30-30	30"		30"			\$ 669	
	S-FB-C-30-36	36"		30"			\$ 669	
	S-FB-C-36-24	24"		36"	9 Lbs.	0.2 Cu Ft	\$ 669	
	S-FB-C-36-30	30"		36"			\$ 669	
	S-FB-C-36-36	36"		36"			\$ 669	
	S-FB-C-42-24	24"		42"			\$ 669	
	S-FB-C-42-30	30"		42"			\$ 669	
	S-FB-C-42-36	36"		42"	9 Lbs.	0.2 Cu Ft	\$ 669	
	S-FB-C-48-24	24"		48"			\$ 669	
	S-FB-C-48-30	30"		48"			\$ 669	
	S-FB-C-48-36	36"		48"	12 Lbs.	0.3 Cu Ft	\$ 669	
	S-FB-C-60-24	24"		60"			\$ 950	
	S-FB-C-60-30	30"		60"			\$ 950	
	S-FB-C-60-36	36"		60"	15 Lbs.	0.3 Cu Ft	\$ 950	
	S-FB-C-72-24	24"		72"			\$ 950	
	S-FB-C-72-30	30"		72"			\$ 950	
	S-FB-C-72-36	36"		72"	18 Lbs.	0.4 Cu Ft	\$ 950	
	S-FB-C-82-24	24"		82"			\$ 950	
	S-FB-C-82-30	30"		82"			\$ 950	
	S-FB-C-82-36	36"		82"	21 Lbs.	0.4 Cu Ft	\$ 950	
	S-FB-C-96-24	24"		96"			\$ 950	
	S-FB-C-96-30	30"		96"			\$ 950	
	S-FB-C-96-36	36"		96"	24 Lbs.	0.5 Cu Ft	\$ 950	





Model Shown
S-FB-C-72-24



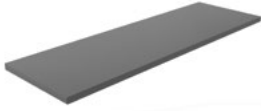

MODEL NUMBER	PRODUCT	WIDTH	DEPTH	HEIGHT	WEIGHT	VOLUME	LIST PRICE	DESCRIPTION
S-FB-S-30-24 S-FB-S-30-30 S-FB-S-30-36	Finished Back Slotwall Option	24"		30"			\$ 813	
		30"		30"			\$ 813	
		36"		30"			\$ 813	
S-FB-S-36-24 S-FB-S-36-30 S-FB-S-36-36		24"		36"	9 Lbs.	0.2 Cu Ft	\$ 813	
		30"		36"			\$ 813	
		36"		36"			\$ 813	
S-FB-S-42-24 S-FB-S-42-30 S-FB-S-42-36		24"		42"	9 Lbs.	0.2 Cu Ft	\$ 813	
		30"		42"			\$ 813	
		36"		42"			\$ 813	
S-FB-S-48-24 S-FB-S-48-30 S-FB-S-48-36		24"		48"	12 Lbs.	0.3 Cu Ft	\$ 813	
		30"		48"			\$ 813	
		36"		48"			\$ 813	
S-FB-S-60-24 S-FB-S-60-30 S-FB-S-60-36		24"		60"	15 Lbs.	0.3 Cu Ft	\$ 1,288	
		30"		60"			\$ 1,288	
		36"		60"			\$ 1,288	
S-FB-S-72-24 S-FB-S-72-30 S-FB-S-72-36		24"		72"	18 Lbs.	0.4 Cu Ft	\$ 1,288	
		30"		72"			\$ 1,288	
		36"		72"			\$ 1,288	
S-FB-S-82-24 S-FB-S-82-30 S-FB-S-82-36		24"		82"	21 Lbs.	0.4 Cu Ft	\$ 1,288	
		30"		82"			\$ 1,288	
		36"		82"			\$ 1,288	
S-FB-S-96-24 S-FB-S-96-30 S-FB-S-96-36		24"		96"	24 Lbs.	0.5 Cu Ft	\$ 1,288	
		30"		96"			\$ 1,288	
		36"		96"			\$ 1,288	





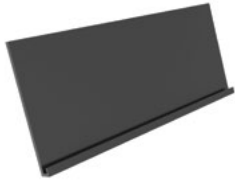

Model Shown
S-FB-S-72-24



SHELVING

	MODEL NUMBER	PRODUCT	WIDTH	DEPTH	HEIGHT	WEIGHT	VOLUME	LIST PRICE	DESCRIPTION
 Model Shown DM-F12-36	M-F10-24	Flat Metal Shelf	23 1/4"	9 1/2"	3/4"			\$ 69	
	M-F12-24		23 1/4"	11 1/2"	3/4"			\$ 69	
	M-F10-30		29 1/4"	9 1/2"	3/4"			\$ 69	
	M-F12-30		29 1/4"	11 1/2"	3/4"			\$ 69	
	M-F10-36		35 1/4"	9 1/2"	3/4"	5 Lbs.	0.2 Cu Ft	\$ 69	
	M-F12-36		35 1/4"	11 1/2"	3/4"	6 Lbs.	0.2 Cu Ft	\$ 75	
 Model Shown DM-LB12-36	M-LB10-24	Low Back Metal Shelf	23 1/4"	9 1/2"	1 3/4"			\$ 69	
	M-LB12-24		23 1/4"	11 1/2"	1 3/4"			\$ 75	
	M-LB10-30		29 1/4"	9 1/2"	1 3/4"			\$ 69	
	M-LB12-30		29 1/4"	11 1/2"	1 3/4"			\$ 75	
	M-LB10-36		35 1/4"	9 1/2"	1 3/4"	5 Lbs.	0.2 Cu Ft	\$ 75	
	M-LB12-36		35 1/4"	11 1/2"	1 3/4"	6 Lbs.	0.2 Cu Ft	\$ 81	
 Model Shown DM-SL12-36	M-SL12-24	Metal Picture Book Shelf	23 1/4"	11 1/2"	4 3/4"	9 Lbs.	1 Cu Ft	\$ 244	
	M-SL12-30		29 1/4"	11 1/2"	4 3/4"			\$ 244	
	M-SL12-36		35 1/4"	11 1/2"	4 3/4"			\$ 250	
 Model Shown SL12-36	SL12-24	Slotted Metal Shelf	23 1/4"	11 1/2"	5			\$ 200	
	SL12-30		29 1/4"	11 1/2"	5			\$ 200	
	SL12-36		35 1/4"	11 1/2"	5			\$ 219	





	MODEL NUMBER	PRODUCT	WIDTH	DEPTH	HEIGHT	WEIGHT	VOLUME	LIST PRICE	DESCRIPTION
 <p>Model Shown DM-M12-36</p>	M-M12-24	Metal Magazine Shelf	23 1/4"	2	12	8 Lbs.	0.2 Cu Ft	\$ 125	
	M-M12-30		29 1/4"	2	12			\$ 125	
	M-M12-36		35 1/4"	2	12			\$ 125	
 <p>Model Shown DM-ME12-36</p>	M-ME12-24	Metal Media Shelf	23 1/4"	4 3/4"	12	15 Lbs.	1 Cu Ft	\$ 75	
	M-ME12-30		29 1/4"	4 3/4"	12			\$ 81	
	M-ME12-36		35 1/4"	4 3/4"	12			\$ 81	
 <p>Model Shown S-SWS32</p>	S-SWS08	Slot Wall Display Shelves	8"	3 1/2"	5 1/2"	1 Lbs.	0.1 Cu Ft	\$ 69	
	S-SWS16		16"	3 1/2"	5 1/2"	1.5 Lbs.	0.1 Cu Ft	\$ ____	
	S-SWS32		32"	3 1/2"	5 1/2"	2.5 Lbs.	0.1 Cu Ft	\$ ____	
 <p>Model Shown DM-GSB</p>	M-GSB	Bottom Metal Grooved Shelf Option						\$ 44	

	MODEL NUMBER	PRODUCT	WIDTH	DEPTH	HEIGHT	WEIGHT	VOLUME	LIST PRICE	DESCRIPTION
	S-FPS	Top Filler Panel, Single Face				2 Lbs.	0.1 Cu Ft	\$ 163	
	S-FPD	Top Filler Panel, Double Face				4 Lbs.	0.1 Cu Ft	\$ 269	
	S-FPT	Top Filler Panel, Tristar				5 Lbs.	0.1 Cu Ft	\$ 363	
	S-FPF	Front Filler Panel				5 Lbs.	0.1 Cu Ft	\$ 388	

SHELVING

	MODEL NUMBER	PRODUCT	WIDTH	DEPTH	HEIGHT	WEIGHT	VOLUME	LIST PRICE	DESCRIPTION
	S-MS3624	Mobile Shelving Bottom Frame (Max 60" H Shelving)	36"	24"				\$ 475	
	S-SB	Sway Brace	60"					\$ 113	

SHELVING

	MODEL NUMBER	PRODUCT	WIDTH	DEPTH	HEIGHT	WEIGHT	VOLUME	LIST PRICE	DESCRIPTION
 Model Shown DM-BE6	M-BE6	Metal Book End	5"	5"	6"	0.8 Lbs.	0.1 Cu Ft	\$ 19	
	M-BE9		5"	5"	9"	1 Lbs.	0.1 Cu Ft	\$ 25	
	S-H35	Hanging Kick Bag Rod	35 1/4"	3/8"	3/8"	6 Lbs.	0.1 Cu Ft	\$ 194	
	S-140	Wall Mounted Newspaper Rack	35 1/4"	12"	30 1/2"	40 Lbs.	9 Cu Ft	\$ 763	
	G-NS	Newspaper Stick	34"	3/4"		0.5 Lbs.	0.1 Cu Ft	\$ 88	

Palmieri Furniture Limited ("Palmieri") warrants that its products and collections are free from defects in materials and workmanship for the life of the product, except as set forth below. Palmieri Limited Lifetime Warranty is valid from the date of delivery.

Exceptions to the Limited Lifetime Warranty: Seating: two (2) years

Goods sold hereunder are covered by a Limited Lifetime Warranty, free against defects in material and workmanship provided the goods and services are subjected to normal use and service. The applicable warranty period commences from shipping date to Purchaser of any item of the goods, whichever occurs first, or any other warranty period otherwise stipulated in writing by Palmieri under this sale. For components not supplied by Palmieri, the original manufacturer's warranty shall apply to the extent assignable by Palmieri. The obligation under this warranty is limited to the repair or replacement, at Palmieri's option, of defective parts F.O.B. point of shipment provided that prompt notice of any defect is given by Purchaser to Palmieri in writing within the applicable warranty period and that upon the Purchaser's return of the defective parts to Palmieri or, if designated by Palmieri, to the location where the works are made, properly packed and with transportation charges prepaid by Purchaser, an inspection thereof shall reveal to Palmieri's satisfaction that Purchaser's claim is valid under the terms of this warranty. Purchaser shall assume all responsibility and expense for dismantling, removal, re-installation and freight in connection with the foregoing. The same obligations and conditions extend to replacement parts furnished by Palmieri hereunder.

Palmieri does not assume liability for installation, labour or consequential damages. Palmieri makes no warranty other than the one set forth herein. All other warranties, legal, expressed or implied, including but not limited to any expressed or implied warranty of merchantability, of fitness for the intended use thereof or against infringement are hereby expressly excluded. The applicable warranty ceases to be effective if the goods are altered or repaired other than by persons authorized or approved by Palmieri to perform such work. Repairs or replacement deliveries do not interrupt or prolong the term of the warranty. The warranty ceases to be effective if Purchaser fails to handle and use the goods sold hereunder in a safe and reasonable manner and in accordance with any written instructions from the manufacturers.

Warranty Does Not Apply To Product Failure Or Loss Resulting From:

Abuse, misuse or accident, alteration or modification of product by customer or third party, normal wear and tear, improper installation, handling or incorrect use. The substitution of part components or hardware not approved or authorized by Palmieri, acts of God, unauthorized repairs, improper storage, and environmental conditions such as irregular temperature control either inside or outside the environment.

Warranty Provides Exclusive Remedies:

If a product fails under ordinary use as a result of a defect in material or workmanship, Palmieri will: (A) repair, or (B) replace the furniture. The replacement or repair of the Furniture or Seating will be at the discretion of Palmieri. If the defect or workmanship cannot be remedied on site, repairs can be made at the factory. (C) If the product repair or replacement is not commercially practicable or cannot be remade in a timely manner Palmieri will refund the purchase price of the affected product. A product "**Defect**" means: an inadequacy in the materials or workmanship of the product that (A) existed at the time when you received the product from Palmieri or Palmieri authorized Reseller and (B) causes a failure of the product to perform under ordinary use in accordance with the materials and documentation accompanying the product. "**Ordinary Use**" means: use of the product (A) in accordance with all applicable local, state or federal laws, codes and regulations and (B) in accordance with manufacturer recommendations and or instructions in the materials and documentation accompanying the product or through shop drawings. A "**Palmieri Authorized Reseller**" means: any dealer that is legally permitted to conduct business in the jurisdiction where the product is sold and is duly authorized by Palmieri to sell the product.

Warranty work must be approved by authorized personnel of Palmieri Furniture Limited in Richmond Hill, Ontario, Canada.

A copy of the original purchase order must accompany all claims.

Warranty Does Not Cover:

Matching of colours, stains, textures, grains and any other variations in materials. Select and Custom Surfaces and materials are only warranted for their application on the specified product and are not covered by our warranty, except as warranted by the original supplier, for quality, colorfastness, shade variations or abrasion and textiles purchased for Palmieri product.

This limited warranty is the sole remedy for product defect and no other express or implied warranty is provided. Warranty is not transferable and valid only for the original purchaser acquiring a product from Palmieri or a Palmieri authorized reseller for the purchaser's own use and not for resale, remarketing or distribution. Limited Lifetime Warranty (25 years)

GENERAL

The following Terms and Conditions of Quote and Sale shall apply to any sale of goods and services by Palmieri Furniture Limited (hereinafter called "Palmieri"). Purchaser shall be deemed to have full knowledge of the terms and conditions herein and such terms and conditions shall be binding if either the goods and services referred to herein are delivered to and accepted by Purchaser, or if Purchaser does not within five (5) days from the date hereof deliver to Palmieri written objection to said terms and conditions or any part thereof.

In the event of any conflict or inconsistency between the terms and conditions of sale herein and the terms and conditions contained in Purchaser's order or in any other form issued by Purchaser, whether or not any such form has been acknowledged or accepted by Palmieri, Palmieri's terms and conditions herein shall prevail. No waiver, alteration or modification of these terms and conditions shall be binding upon Palmieri unless made in writing and signed by a duly authorized representative of Palmieri.

1. QUOTATIONS / PRODUCT QUOTED

Unless otherwise stated, **Palmieri's quotations shall be null and void unless accepted by Purchaser within thirty (30) days from the date of quotation.** Quotes may be subject to change before order placement, due to increased material costs and or other factors that could impact the final cost of production and our final understanding of the product required. If the items quoted do not reflect the intended product requirements of the customer, Palmieri will not be held responsible for increased costs for those product changes. We reserve the right to edit or re-quote any portion of a previously submitted quotation subject to our final understanding of the product required by the client.

2. PALMIERI DRAWINGS

Palmieri provides drawings for Custom & Standard product we produce to our clients upon request. We consider these drawings to be Private and Confidential and are provided for the sole purpose and use of our clients to understand the product we are providing. The use of these confidential materials is limited to the transaction between the parties and at no point are these confidential materials to be sent to any of our competitors or parties quoting for the same purpose.

A minimum \$85.00 NET Engineering Administrative Fee will apply for Custom Product Drawings

(Note: The first set of Custom product drawings will be free of charge)

A minimum \$120.00 NET Engineering Administrative Fee will apply for all Standard Product Drawings

3. TERMS OF PAYMENT

For authorized customers; Orders at a \$75,000.00 threshold will require a mandatory 25% deposit. Orders over and above \$100,000.00 requires a mandatory (25%) deposit at time of order, a mandatory (25%) deposit prior to product shipment and the balance to be paid within thirty (30) days of date of shipment. Payment not be made to Palmieri when due, Palmieri reserves the right to charge Purchaser with interest on such overdue payments. Interest of 2% per month (24% per annum) is charged on all overdue accounts, unless otherwise specified. The charging of such interest shall not be construed as obligating Palmieri to grant any extension of time in the terms of payment. All goods remain the property of Palmieri, until balance is paid in full to Palmieri.

4. TITLE

Title to the goods or any part thereof shall not pass from Palmieri to Purchaser until all payments due hereunder have been duly made, except as otherwise expressly stipulated herein. The goods shall be and remain personal or moveable property, notwithstanding their mode of attachment to realty or other property. If default is made in any of the payments herein, Purchaser agrees that Palmieri may retain all payments which have been made on account of the purchase price as liquidated damages, and Palmieri shall be free to enter the premises where the goods may be located and remove them as Palmieri's property, without prejudice to Palmieri's right to recover any further expenses or damages Palmieri may suffer by reason of such nonpayment.

5. TAXES

Prices do not include Goods & Services Tax, Provincial or Municipal sales, use, value-added or similar tax. All applicable taxes are extra. Our Harmonized Sales Tax (HST) registration number is R104055066.

6. THE AGREEMENT

An acceptance and official confirmation of Purchasers' order by signing Palmieri's Order Confirmation the Purchaser therefore is accepting terms and conditions as expressed herein Palmieri's Terms and Conditions of Quote and Sale by Palmieri and shall constitute the complete agreement, subject to the terms and conditions of sale herein set forth, and shall supersede all previous quotations, orders or agreements.

7. LEAD TIME / DELIVERY / DELAYS

Lead time is determined only when final material/finish selection and drawing approvals are received by Palmieri from the client. The accuracy of Palmieri's lead times, is created to the best of our ability with the information provided to us. Confirmed lead time is conveyed to the client by means of Order Confirmation. They do not preclude the client from checking the accuracy of your requirement and our Order Confirmation. Any noted discrepancies are to be reported immediately to Palmieri Customer Service Department for correction and re-issue of revised Order Confirmation. By signing and dating the Order Confirmation the client accepts the terms and conditions of quote and sale.

Lead time on our Order Confirmation do not account for delays that could potentially occur for special materials specified by the client that are outside of our standard finishes and materials program that are out of our control

and will affect the lead time on the order. Palmieri will notify the client immediately when these delays occur and adjust the lead time accordingly.

Delivery schedules are approximate and are based on prevailing market conditions applicable respectively at the time of Palmieri's quotation and Palmieri's acceptance of clients' order, if certain portions of an order are completed by the quoted lead time while other portions have experienced delays outside of our control. The client may choose to part ship the order at their discretion and expense. Otherwise the entire order will ship with the delayed portion at a later date. Palmieri may extend delivery schedules or may, at its option, cancel Purchaser's order in full or in part without liability other than to return any deposit or prepayment which is unearned by reason of the cancellation.

8. CHANGES AND CANCELLATION

Orders accepted by Palmieri are not subject to changes or cancellation by Purchaser without the written consent of Palmieri. In such cases where Palmieri authorizes changes or cancellation, Palmieri reserves the right to charge the Purchaser with reasonable costs based upon expenses already incurred and commitments made by Palmieri, including, without limitation, any labour done, material purchased and also including Supplier's usual overhead and reasonable profit and cancellation charges from Palmieri's suppliers. Palmieri will communicate to the Purchaser additional costs incurred by way of Revised Order Confirmation. Revised Order Confirmation will include applicable costs incurred and modification to lead times (if applicable). The Purchaser must provide Palmieri written confirmation of additional costs, before any changes can be processed on the order.

A minimum charge of \$100.00 NET Change Order Request fee will apply

A minimum charge of \$150.00 NET Cancel Order Request fee will apply.

9. SHIPPING LOCATION / SHIPPING QUOTES / COST OF TRANSPORTATION

Unless otherwise stated, all prices are F.O.B. our factory in Richmond Hill, Ontario, Canada.

Customary methods of transportation shall be selected by Palmieri and such transportation will be at Purchaser's expense. Shipping quotations are made at time of furniture quotation and are outside the control of Palmieri. **Shipping quotes are valid for ten (10) business days from the time of quote.** We do our best to maintain shipping costs as quoted, however all shipping weights and cubic feet shown are approximate only, various construction materials and packaging methods may add to the weights given. All quoted prices, unless otherwise stated on the quotation, are based on the current exchange rates, tariffs, fuel surcharges and costs of manufacture and are subject to change by Palmieri with or without notice until Purchaser's acceptance. Palmieri does not assume responsibility or liability for shipping costs, product during transit, or variances from the shipping weights or cubic feet shown in our specification guides. Special methods of transportation will be used upon Purchaser's request and at Purchaser's additional expense, provided reasonable notice of Purchaser's transportation requirements are given by Purchaser to Palmieri prior to shipment. Palmieri will notify the client prior to shipping product if shipping costs as quoted change, at which point the client must approve the adjusted shipping costs.

10. RECEIVING PRODUCT / REPORTING DAMAGE / STORAGE OF PRODUCT

Upon receipt of Palmieri product, the receiver of the goods must immediately inspect the product to ensure it is free of shipping damage. If the product is deemed in good order, the receiver of the product must ensure

to sign off on the accompanying carriers Bill of lading in good condition. Except for obligations stated under "Warranty" herein, Palmieri's responsibility for the product ceases once the product has been received and signed off in good order and is the full responsibility of the receiver and subsequently the owner.

In the event shipping damage is discovered during receipt of shipment, it is the responsibility of the receiver to ensure all noted damage is recorded on the carrier's Bill of Lading prior to sign off. All noted shipping damage claims must be reported to Palmieri within **24 hours** of receipt of the product onsite, failure to do so will result in the claim being deemed null and void. All shipping damage claims are to be reported directly to Palmieri's Shipping Manager. Please call our toll free number at **1-800-413-4440 ext. 33** or submit the claim by Fax directly to **1-905-731-9878**. Palmieri will not accept any shipping damage claims submitted **after 24 hours** and it shall be conclusively presumed that the goods were delivered in good condition.

Storage of product, Palmieri will not be held responsible for any potential damages or shortages for product shipped and received by Purchaser and is subsequently placed into storage and not inspected within 24 hours of receipt.

11. INSTALLATION / SHORTAGES / BACK CHARGES

Unless otherwise expressly stipulated, the goods shall be installed by and at the risk and expense of Purchaser.

In the event that Palmieri is requested to supervise such installation, Palmieri's responsibility shall be limited to exercising that degree of skill customary in the trade in supervising installations of the same type. Purchaser shall remain responsible for all other aspects of the work including compliance with the local regulations. It is the responsibility of the Purchaser to ensure hardware and parts are received in good order. Packing slip and hardware list to be provided by Palmieri with every order at time of shipping. Purchaser has the responsibility to notify Palmieri immediately without delay of issues that arise; subsequently Palmieri will take action to provide prompt resolution.

Shortages must be reported to Palmieri within **24 hours** of receipt of the goods and failure to do so may be at the expense of the Purchaser.

If deemed missing hardware and parts short shipped from the factory, Palmieri will arrange to ship freight prepaid to destination. Palmieri will only be responsible for replacement costs of missing hardware and parts, any labour costs incurred will be the responsibility of the Purchaser and will not be approved by Palmieri.

Back Charges will only be approved if we deemed a defect in the material or workmanship is found during the installation period resulting in a return trip to the job-site to complete installation. It shall remain the sole discretion of Palmieri to approve (A) repair or (B) replace the furniture and any labour costs incurred by the Purchaser.

12. FORCE MAJEURE

Palmieri shall not be responsible or liable for any loss or damage incurred by Purchaser herein resulting from causes beyond the reasonable control of Palmieri including, but without limitation, abuse, misuse or accident, alteration or modification of product by customer or third party, normal wear and tear, improper installation, handling or incorrect use, unauthorized repairs, the substitution of part components or hardware not approved or authorized by Palmieri, improper storage, and environmental conditions such as irregular temperature control

either inside or outside the environment, acts of God, fire, flood, delays in transportation, or the failure of Palmieri's suppliers to meet their delivery promises. The acceptance of delivery of the goods by Purchaser shall constitute a waiver of all claims for loss or damage due to any delay whatsoever.

13. RETURNED GOODS

No goods may be returned to Palmieri for a credit or exchanged without Palmieri's prior written consent.

Palmieri reserves the right to accept all returns and subject to a handling/restocking charge or to decline all returns. Even after Palmieri has authorized the return of goods for credit, Palmieri reserves the right to adjust the amount of any credit given to Purchaser on return of the goods based on the conditions of the goods on arrival in Palmieri's warehouse. Credit for returned goods will be issued to Purchaser only where such goods are returned by Purchaser and not by any subsequent owner of the goods. Goods will be considered for return only if they are in their original condition and packaging. Palmieri Goods Return Authorization Form to be issued and **must** accompany all shipments returning back to the factory. **Return freight must be prepaid by Purchaser. A minimum 20% re-stocking fee will apply.**

1230 Reid Street
Richmond Hill
Ontario Canada
L4B 1C4

T 905 731 9300
F 905 731 9878
TF 800 413 4440

info@palmierifurniture.com
www.PalmieriFurniture.com

SPECIFICATION GUIDE & PRICE LIST

2017

PALMIER

SHELVING
DURECON WOOD

CATEGORY: LIBRARY FURNITURE
CONTRACT: BID #ESCNJ 17/18-16

Introduction	1
Table of Contents	2-7
Product Materials & Finishes	8-9

Durecon Wood Shelving 10-133

 **Single Face Shelving** 10-17
 Durecon Shelving is available Single Face and Double Face in heights from 30" to 96", each with widths of 24", 30" and 36". Durecon Shelving is available with the following options

 **Double Face Shelving** 18-25
 Durecon Shelving is available Single Face and Double Face in heights from 30" to 96", each with widths of 24", 30" and 36". Durecon Shelving is available with the following options

 **Single Face Shelving – Plastic Laminate Top** 26-31
 Durecon Shelving is available Single Face and Double Face in heights from 30" to 96", each with widths of 24", 30" and 36". Durecon Shelving is available with the following options
 Individual shelving tops have a .050" thick plastic laminate sheet, the underside complete with a .020" thick backer sheet. Suitable for shelving up to 60" Height ONLY

 **Double Face Shelving – Plastic Laminate Top** 32-35
 Durecon Shelving is available Single Face and Double Face in heights from 30" to 96", each with widths of 24", 30" and 36". Durecon Shelving is available with the following options
 Individual shelving tops have a .050" thick plastic laminate sheet, the underside complete with a .020" thick backer sheet. Suitable for shelving up to 60" Height ONLY

 **Single Face Shelving – Wood/Glass Doors** 36-43
 Frame made of 3/4" Thick Solid Hardwood. Vertical stiles will be 3/4" thick x 2 1/2" wide, top stile 2 1/2" wide and bottom 3 1/4" wide tempered glass. Complete with locks and door pulls.
 **When this option is requested the shelves will remain solid hardwood. Actual depth of shelves will decrease by 1".

 **Double Face Shelving – Wood/Glass Doors** 44-51
 Frame made of 3/4" Thick Solid Hardwood. Vertical stiles will be 3/4" thick x 2 1/2" wide, top stile 2 1/2" wide and bottom 3 1/4" wide tempered glass. Complete with locks and door pulls.
 **When this option is requested the shelves will remain solid hardwood. Actual depth of shelves will decrease by 1".

 **Single Face Shelving – Wood/Glass Doors, Glass Shelves** 52-59
 Frame made of 3/4" Thick Solid Hardwood. Vertical stiles will be 3/4" thick x 2 1/2" wide, top stile 2 1/2" wide and bottom 3 1/4" wide tempered glass. Complete with locks and door pulls.

 **Double Face Shelving – Wood/Glass Doors, Glass Shelves** 60-67
 Frame made of 3/4" Thick Solid Hardwood. Vertical stiles will be 3/4" thick x 2 1/2" wide, top stile 2 1/2" wide and bottom 3 1/4" wide tempered glass. Complete with locks and door pulls.

 **Single Face Shelving – Wood Doors** 68-75
 Constructed from 3/4" veneer plywood, edges to be banded with 1/4" external hardwood edge. 1" Chrome piano hinges with magnetic touch latch. Complete with locks and door pulls. **Overall depth of shelves will decrease by 1". Please specify with a layout which bay of shelving will receive doors.

 **Double Face Shelving – Wood Doors** 76-83
 Constructed from 3/4" veneer plywood, edges to be banded with 1/4" external hardwood edge. 1" Chrome piano hinges with magnetic touch latch. Complete with locks and door pulls. **Overall depth of shelves will decrease by 1". Please specify with a layout which bay of shelving will receive doors.

 **Single Face Shelving – Sliding Glass Doors** 84-91
 1/4" Thick tempered glass doors. Shelving fitted with aluminum roller tracks, on bottoms and tops. Each door has a finger pull and case lock. Unit complete with locks. **When this option is requested the shelves will remain solid hardwood. Overall depth will increase by 2 1/4". Please specify with a layout which bay of shelving will receive doors.

 **Double Face Shelving – Sliding Glass Doors** 92-99
 1/4" Thick tempered glass doors. Shelving fitted with aluminum roller tracks, on bottoms and tops. Each door has a finger pull and case lock. Unit complete with locks. **When this option is requested the shelves will remain solid hardwood. Overall depth will increase by 2 1/4". Please specify with a layout which bay of shelving will receive doors.

 **Single Face Shelving – Sliding Glass Doors, Glass Shelves** 100-107
 1/4" Thick tempered glass doors. Shelving fitted with aluminum roller tracks, on bottoms and tops. Each door has a finger pull and case lock. Unit complete with locks. **Overall depth will increase by 2 1/4". Please specify with a layout which bay of shelving will receive doors.

	Double Face Shelving – Sliding Glass Doors, Glass Shelves 1/4" Thick tempered glass doors. Shelving fitted with aluminum roller tracks, on bottoms and tops. Each door has a finger pull and case lock. Unit complete with locks. **Overall depth will increase by 2 1/4". Please specify with a layout which bay of shelving will receive doors.	108-115
--	--	---------

	Single Face Shelving – Magazine Shelving Magazine Shelving is available Single Face and Double Face in heights from 30" to 72", each with widths of 24", 30" and 36".	116-117
--	--	---------

	Double Face Shelving – Magazine Shelving Magazine Shelving is available Single Face and Double Face in heights from 30" to 72", each with widths of 24", 30" and 36".	118-119
--	--	---------

	Single Face Shelving – Magazine Shelving, Plastic Laminate Top Magazine Shelving is available Single Face and Double Face in heights from 30" to 72", each with widths of 24", 30" and 36". Individual shelving tops have a .050" thick plastic laminate sheet, the underside complete with a .020" thick backer sheet. Suitable for shelving up to 60" Height ONLY.	120-121
---	---	---------

	Double Face Shelving – Magazine Shelving, Plastic Laminate Top Magazine Shelving is available Single Face and Double Face in heights from 30" to 72", each with widths of 24", 30" and 36". Individual shelving tops have a .050" thick plastic laminate sheet, the underside complete with a .020" thick backer sheet. Suitable for shelving up to 60" Height ONLY.	122-123
--	---	---------

	Single Face Shelving – Picture Book Shelving Durecon Picture Book Shelving is available Single Face and Double Face in heights from 30" to 48", each with widths of 24", 30" and 36".	124-125
--	--	---------

	Double Face Shelving – Picture Book Shelving Durecon Picture Book Shelving is available Single Face and Double Face in heights from 30" to 48", each with widths of 24", 30" and 36".	126-127
--	--	---------

	Single Face Shelving – Picture Book Shelving, Plastic Laminate Top Durecon Picture Book Shelving is available Single Face and Double Face in heights from 30" to 48", each with widths of 24", 30" and 36". Individual shelving tops have a .050" thick plastic laminate sheet, the underside complete with a .020" thick backer sheet. Suitable for shelving up to 60" Height ONLY	128-129
---	--	---------

	Double Face Shelving – Picture Book Shelving, Plastic Laminate Top Durecon Picture Book Shelving is available Single Face and Double Face in heights from 30" to 48", each with widths of 24", 30" and 36". Individual shelving tops have a .050" thick plastic laminate sheet, the underside complete with a .020" thick backer sheet. Suitable for shelving up to 60" Height ONLY	130-131
---	--	---------

	A-Frame Shelving	132-133
---	------------------	---------

Components	134-143
-------------------	----------------

	Bolt Assembly End Panels	134-135
---	--------------------------	---------

	Bolt Assembly Mid Panels	136-137
---	--------------------------	---------

	Bolt Assembly Shelves	138-139
---	-----------------------	---------

	Printed Backs – Single Face	140-141
---	-----------------------------	---------

	Printed Backs – Double Face	142-143
---	-----------------------------	---------

Options & Accessories

144-165



Sloped Continuous Plastic Laminate Tops

144-145



Veneer Backs - Single Face

146-147



Veneer Backs - Double Face

148-149



Finished Back Veneer Option

150-151



Finished Back Cork Option

152-153



Finished Back Slotwall Option

154-155



Shelves

156-159



Filler Panels

160-161



Mobile Shelving, Multi Bin Shelf, Pull-Out Media Drawer,
Fixed Media Drawer, Sway Brace

162-163



Metal Book End, Hanging Kick Bag Rod,
Wall Mounted Newspaper Rack, Newspaper Stick

164-165

Warranty

166

Terms & Conditions

167

WOODS & FINISHES:

Natural Maple

Standard



Natural Clear – M-NA

Maple Finishes

The following stains are available, add 10% to list

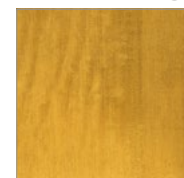

Castle Oak – M-CO

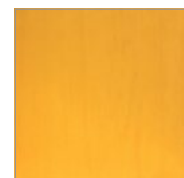

Honey Oak – M-HO

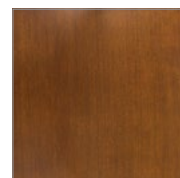

English Oak – M-EN

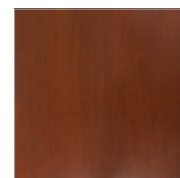

Victorian Cherry – M-VI

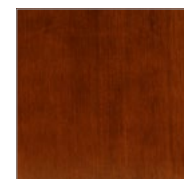

Richmond Cherry – M-RC

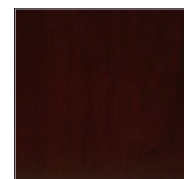

Mahogany – M-MA



Java – M-JA



Wenge – M-WE

Natural Red Oak

Standard

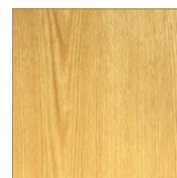

Natural Clear – O-NA

Red Oak Finishes

The following stains are available, add 10% to list

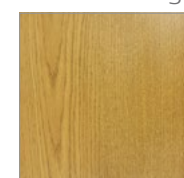

Castle Oak – O-CO

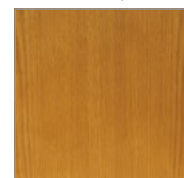

Honey Oak – O-HO

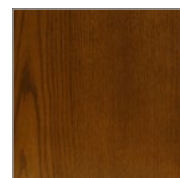

English Oak – O-EN



Victorian Cherry – O-VI



Richmond Cherry – O-RC



Mahogany – O-MA



Java – O-JA



Wenge – O-WE

Natural Cherry

Add 20% to list

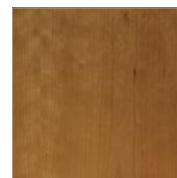

Natural Clear – C-NA

Cherry Finishes

The following stains are available, add 30% to list



Honey Oak – C-HO



Richmond Cherry – C-RC

Natural Walnut

Add 20% to list

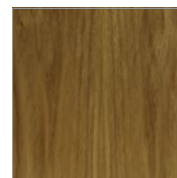

Natural Clear – W-NA

Walnut Finishes

The following stain is available, add 30% to list



Java – W-JA

HARDWOODS: All hardwood materials used in the manufacturing of Palmieri products shall be Northern grown hardwoods. Hardwoods will be air and kiln dried to a moisture content of 5-7%. All hardwoods shall be of grade "A" material, free of material stains, imperfections, conformity of grain, texture and color. Hardwood species shall be Northern grown Red Oak, Clear White Northern Maple and Birch. American Cherry and Honduras Mahogany and Walnut are available. Please inquire for pricing.

VENEER: Exposed face veneers shall be not less than 1/28" thick plain sliced veneers. Veneers are to be selected for conformity of grain direction and color. Veneers are to be stitched tightly in a book match, slip match or plain sliced configuration. Unexposed veneers are to be of hardwood but not selected for color, or grain quality. Veneers are not to be lap joined or reveal any tape or glue lines.

PARTICLE BOARD CORE: The particleboard shall be formed of wood chips, bonded with a water resistance adhesive. The particleboard material is to be of a high density 45 lbs/cu. ft. having a minimum average modulus of rupture of 2400 psi and a minimum average modulus of elasticity of 4,000,000 psi.

VENEER CORE: Veneer core is to be constructed with odd numbers of plies. Each ply is to be laminated in pairs and cross banded in opposite directions with grain direction at a 90 degree angle to the grain of the center core. All plies are to be free from knots, wrinkles, laps or other natural or manufacturing defects.





LUMBER CORE: Lumber core is to be of the highest quality grade. Grade "A" select stock. Lumber core shall be constructed of solid random width strips not less than 2" wide nor more than 3 1/2" wide by 1" thick. Wood strips will be free from knots or other defects. All strips will be tightly joined using water resistance adhesives.





HIGH PRESSURE LAMINATE: Work surface laminate shall be .050" thick and used with balancing backer sheet of no less than .028" thick. Laminate shall conform to standards set by the American Standards Institute/National Electrical Manufacturers Association (ANSI/NEMA) for thickness, performance and appearance. Printed colours, abstract patterns and wood grains are reproduced from representative segments of large sheets and may differ slightly from the actual product.

FINISHING PROCEDURES: All materials shall be inspected and treated with a final sanding and polishing operation before any staining and final finishing can be performed. All machine and mill marks are to be removed. Once the polishing and sanding has been performed, the furniture will then undergo the following stain and finishing procedures:

- Step 1 A base stain will be uniformly applied, wiped and then allowed to dry under factory controlled conditions.
- Step 2 A uniform coat of sealer will be applied and allowed to dry.
- Step 3 Sealer will be lightly sanded using 240 grit silicon paper.
- Step 4 A catalytic lacquer of 34-45 degree sheen is evenly applied and allowed to dry under factory controlled conditions.

MODEL NUMBER	PRODUCT	WIDTH	DEPTH	HEIGHT	SHELF DEPTH	# OF SHELVES	# OF OPENINGS	WEIGHT	VOLUME	LIST PRICE	DESCRIPTION
 DW-3010-S-24	Single Face Starter	25 1/4"	10 1/8"	30"	9 1/2"	1	2			\$ 1,125	End, Mid, Top and Base Panels to be constructed from 1" thick 11-ply solid core, veneered 2 sides. Vertical, top and bottom edges banded with 1/4" external hardwood edging, edges to be eased. Front Edge: 3/4" thick x 2 1/2" high fascia - tongue and grooved to top.
DW-3010-A-24	Single Face Adder	24 1/4"	10 1/8"	30"	9 1/2"	1	2			\$ 844	
DW-3012-S-24	Single Face Starter	25 1/4"	12 1/8"	30"	11 1/2"	1	2			\$ 1,163	
DW-3012-A-24	Single Face Adder	24 1/4"	12 1/8"	30"	11 1/2"	1	2			\$ 894	
DW-3010-S-30	Single Face Starter	31 1/4"	10 1/8"	30"	9 1/2"	1	2			\$ 1,125	
DW-3010-A-30	Single Face Adder	30 1/4"	10 1/8"	30"	9 1/2"	1	2			\$ 844	
DW-3012-S-30	Single Face Starter	31 1/4"	12 1/8"	30"	11 1/2"	1	2			\$ 1,163	
DW-3012-A-30	Single Face Adder	30 1/4"	12 1/8"	30"	11 1/2"	1	2			\$ 894	
DW-3010-S-36	Single Face Starter	37 1/4"	10 1/8"	30"	9 1/2"	1	2			\$ 981	
DW-3010-A-36	Single Face Adder	36 1/4"	10 1/8"	30"	9 1/2"	1	2			\$ 700	
DW-3012-S-36	Single Face Starter	37 1/4"	12 1/8"	30"	11 1/2"	1	2			\$ 1,019	
DW-3012-A-36	Single Face Adder	36 1/4"	12 1/8"	30"	11 1/2"	1	2			\$ 663	
DW-3610-S-24	Single Face Starter	25 1/4"	10 1/8"	36"	9 1/2"	1	2			\$ 1,081	
DW-3610-A-24	Single Face Adder	24 1/4"	10 1/8"	36"	9 1/2"	1	2			\$ 781	
DW-3612-S-24	Single Face Starter	25 1/4"	12 1/8"	36"	11 1/2"	1	2			\$ 1,125	
DW-3612-A-24	Single Face Adder	24 1/4"	12 1/8"	36"	11 1/2"	1	2			\$ 813	
DW-3614-S-24	Single Face Starter	25 1/4"	14 5/8"	36"	14"	1	2			\$ 1,256	
DW-3614-A-24	Single Face Adder	24 1/4"	14 5/8"	36"	14"	1	2			\$ 913	
DW-3610-S-30	Single Face Starter	31 1/4"	10 1/8"	36"	9 1/2"	1	2			\$ 1,081	
DW-3610-A-30	Single Face Adder	30 1/4"	10 1/8"	36"	9 1/2"	1	2			\$ 781	
DW-3612-S-30	Single Face Starter	31 1/4"	12 1/8"	36"	11 1/2"	1	2			\$ 1,125	
DW-3612-A-30	Single Face Adder	30 1/4"	12 1/8"	36"	11 1/2"	1	2			\$ 813	
DW-3614-S-30	Single Face Starter	31 1/4"	14 5/8"	36"	14"	1	2			\$ 1,256	
DW-3614-A-30	Single Face Adder	30 1/4"	14 5/8"	36"	14"	1	2			\$ 913	
DW-3610-S-36	Single Face Starter	37 1/4"	10 1/8"	36"	9 1/2"	1	2	50.6 Lbs.	4 Cu Ft	\$ 938	
DW-3610-A-36	Single Face Adder	36 1/4"	10 1/8"	36"	9 1/2"	1	2	46 Lbs.	4 Cu Ft	\$ 638	
DW-3612-S-36	Single Face Starter	37 1/4"	12 1/8"	36"	11 1/2"	1	2	50.6 Lbs.	5 Cu Ft	\$ 981	
DW-3612-A-36	Single Face Adder	36 1/4"	12 1/8"	36"	11 1/2"	1	2	47.2 Lbs.	5 Cu Ft	\$ 663	
DW-3614-S-36	Single Face Starter	37 1/4"	14 5/8"	36"	14"	1	2	74.8 Lbs.	6 Cu Ft	\$ 1,106	
DW-3614-A-36	Single Face Adder	36 1/4"	14 5/8"	36"	14"	1	2	63.3 Lbs.	6 Cu Ft	\$ 769	

	MODEL NUMBER	PRODUCT	WIDTH	DEPTH	HEIGHT	SHELF DEPTH	# OF SHELVES	# OF OPENINGS	WEIGHT	VOLUME	LIST PRICE	DESCRIPTION
	DW-4820-S-24	Double Face Starter	25 1/4"	19 1/2"	48"	9 1/2"	4	6			\$ 2,163	End, Mid, Top and Base Panels to be constructed from 1" thick 11-ply solid core, veneered 2 sides. Vertical, top and bottom edges banded with 1/4" external hardwood edging, edges to be eased. Front Edge: 3/4" thick x 2 1/2" high fascia - tongue and grooved to top.
	DW-4820-A-24	Double Face Adder	24 1/4"	19 1/2"	48"	9 1/2"	4	6			\$ 1,619	
	DW-4824-S-24	Double Face Starter	25 1/4"	23 1/2"	48"	11 1/2"	4	6			\$ 2,213	
	DW-4824-A-24	Double Face Adder	24 1/4"	23 1/2"	48"	11 1/2"	4	6			\$ 1,644	
	DW-4828-S-24	Double Face Starter	25 1/4"	28 1/2"	48"	14"	4	6			\$ 2,575	
	DW-4828-A-24	Double Face Adder	24 1/4"	28 1/2"	48"	14"	4	6			\$ 1,956	
Model Shown DW-4224-S-36	DW-4820-S-30	Double Face Starter	31 1/4"	19 1/2"	48"	9 1/2"	4	6			\$ 2,163	
	DW-4820-A-30	Double Face Adder	30 1/4"	19 1/2"	48"	9 1/2"	4	6			\$ 1,619	
	DW-4824-S-30	Double Face Starter	31 1/4"	23 1/2"	48"	11 1/2"	4	6			\$ 2,213	
	DW-4824-A-30	Double Face Adder	30 1/4"	23 1/2"	48"	11 1/2"	4	6			\$ 1,644	
	DW-4828-S-30	Double Face Starter	31 1/4"	28 1/2"	48"	14"	4	6			\$ 2,575	
	DW-4828-A-30	Double Face Adder	30 1/4"	28 1/2"	48"	14"	4	6			\$ 1,956	
	DW-4820-S-36	Double Face Starter	37 1/4"	19 1/2"	48"	9 1/2"	4	6	132 Lbs.	9 Cu Ft	\$ 1,938	
	DW-4820-A-36	Double Face Adder	36 1/4"	19 1/2"	48"	9 1/2"	4	6	109 Lbs.	8 Cu Ft	\$ 1,400	
	DW-4824-S-36	Double Face Starter	37 1/4"	23 1/2"	48"	11 1/2"	4	6	155 Lbs.	11 Cu Ft	\$ 1,988	
	DW-4824-A-36	Double Face Adder	36 1/4"	23 1/2"	48"	11 1/2"	4	6	127 Lbs.	10 Cu Ft	\$ 1,425	
	DW-4828-S-36	Double Face Starter	37 1/4"	28 1/2"	48"	14"	4	6	178 Lbs.	13 Cu Ft	\$ 2,356	
	DW-4828-A-36	Double Face Adder	36 1/4"	28 1/2"	48"	14"	4	6	144 Lbs.	12 Cu Ft	\$ 1,738	
	DW-6020-S-24	Double Face Starter	25 1/4"	19 1/2"	60"	9 1/2"	6	8			\$ 2,238	
	DW-6020-A-24	Double Face Adder	24 1/4"	19 1/2"	60"	9 1/2"	6	8			\$ 1,700	
	DW-6024-S-24	Double Face Starter	25 1/4"	23 1/2"	60"	11 1/2"	6	8			\$ 2,288	
	DW-6024-A-24	Double Face Adder	24 1/4"	23 1/2"	60"	11 1/2"	6	8			\$ 1,744	
	DW-6028-S-24	Double Face Starter	25 1/4"	28 1/2"	60"	14"	6	8			\$ 2,694	
	DW-6028-A-24	Double Face Adder	24 1/4"	28 1/2"	60"	14"	6	8			\$ 2,081	
Model Shown DW-6024-S-36	DW-6020-S-30	Double Face Starter	31 1/4"	19 1/2"	60"	9 1/2"	6	8			\$ 2,238	
	DW-6020-A-30	Double Face Adder	30 1/4"	19 1/2"	60"	9 1/2"	6	8			\$ 1,700	
	DW-6024-S-30	Double Face Starter	31 1/4"	23 1/2"	60"	11 1/2"	6	8			\$ 2,288	
	DW-6024-A-30	Double Face Adder	30 1/4"	23 1/2"	60"	11 1/2"	6	8			\$ 1,744	
	DW-6028-S-30	Double Face Starter	31 1/4"	28 1/2"	60"	14"	6	8			\$ 2,694	
	DW-6028-A-30	Double Face Adder	30 1/4"	28 1/2"	60"	14"	6	8			\$ 2,081	
	DW-6020-S-36	Double Face Starter	37 1/4"	19 1/2"	60"	9 1/2"	6	8	176 Lbs.	11 Cu Ft	\$ 2,013	
	DW-6020-A-36	Double Face Adder	36 1/4"	19 1/2"	60"	9 1/2"	6	8	145 Lbs.	10 Cu Ft	\$ 1,475	
	DW-6024-S-36	Double Face Starter	37 1/4"	23 1/2"	60"	11 1/2"	6	8	200 Lbs.	12 Cu Ft	\$ 2,063	
	DW-6024-A-36	Double Face Adder	36 1/4"	23 1/2"	60"	11 1/2"	6	8	164 Lbs.	11 Cu Ft	\$ 1,519	
	DW-6028-S-36	Double Face Starter	37 1/4"	28 1/2"	60"	14"	6	8	224 Lbs.	13 Cu Ft	\$ 2,469	
	DW-6028-A-36	Double Face Adder	36 1/4"	28 1/2"	60"	14"	6	8	184 Lbs.	12 Cu Ft	\$ 1,856	

MODEL NUMBER	PRODUCT	WIDTH	DEPTH	HEIGHT	SHELF DEPTH	# OF SHELVES	# OF OPENINGS	WEIGHT	VOLUME	LIST PRICE	DESCRIPTION	
 Model Shown DW-7224-S-36	DW-7220-S-24	Double Face Starter	25 1/4"	19 1/2"	72"	9 1/2"	8	10		\$ 2,413	End, Mid, Top and Base Panels to be constructed from 1" thick 11-ply solid core, veneered 2 sides. Vertical, top and bottom edges banded with 1/4" external hardwood edging, edges to be eased. Front Edge: 3/4" thick x 2 1/2" high fascia - tongue and grooved to top.	
	DW-7220-A-24	Double Face Adder	24 1/4"	19 1/2"	72"	9 1/2"	8	10		\$ 1,869		
	DW-7224-S-24	Double Face Starter	25 1/4"	23 1/2"	72"	11 1/2"	8	10		\$ 2,463		
	DW-7224-A-24	Double Face Adder	24 1/4"	23 1/2"	72"	11 1/2"	8	10		\$ 1,913		
	DW-7228-S-24	Double Face Starter	25 1/4"	28 1/2"	72"	14"	8	10		\$ 2,888		
	DW-7228-A-24	Double Face Adder	24 1/4"	28 1/2"	72"	14"	8	10		\$ 2,288		
	DW-7220-S-30	Double Face Starter	31 1/4"	19 1/2"	72"	9 1/2"	8	10		\$ 2,413		
	DW-7220-A-30	Double Face Adder	30 1/4"	19 1/2"	72"	9 1/2"	8	10		\$ 1,869		
	DW-7224-S-30	Double Face Starter	31 1/4"	23 1/2"	72"	11 1/2"	8	10		\$ 2,463		
	DW-7224-A-30	Double Face Adder	30 1/4"	23 1/2"	72"	11 1/2"	8	10		\$ 1,913		
	DW-7228-S-30	Double Face Starter	31 1/4"	28 1/2"	72"	14"	8	10		\$ 2,888		
	DW-7228-A-30	Double Face Adder	30 1/4"	28 1/2"	72"	14"	8	10		\$ 2,288		
 Model Shown DW-7224-A-36	DW-7220-S-36	Double Face Starter	37 1/4"	19 1/2"	72"	9 1/2"	8	10	200 Lbs.	12 Cu Ft		\$ 2,188
	DW-7220-A-36	Double Face Adder	36 1/4"	19 1/2"	72"	9 1/2"	8	10	164 Lbs.	11 Cu Ft		\$ 1,644
	DW-7224-S-36	Double Face Starter	37 1/4"	23 1/2"	72"	11 1/2"	8	10	229 Lbs.	13 Cu Ft		\$ 2,238
	DW-7224-A-36	Double Face Adder	36 1/4"	23 1/2"	72"	11 1/2"	8	10	186 Lbs.	12 Cu Ft		\$ 1,694
	DW-7228-S-36	Double Face Starter	37 1/4"	28 1/2"	72"	14"	8	10	256 Lbs.	14 Cu Ft		\$ 2,669
	DW-7228-A-36	Double Face Adder	36 1/4"	28 1/2"	72"	14"	8	10	207 Lbs.	13 Cu Ft		\$ 2,063
	DW-8220-S-24	Double Face Starter	25 1/4"	19 1/2"	82"	9 1/2"	10	12				\$ 2,575
 Model Shown DW-8224-S-36	DW-8220-A-24	Double Face Adder	24 1/4"	19 1/2"	82"	9 1/2"	10	12				\$ 2,031
	DW-8224-S-24	Double Face Starter	25 1/4"	23 1/2"	82"	11 1/2"	10	12				\$ 2,638
	DW-8224-A-24	Double Face Adder	24 1/4"	23 1/2"	82"	11 1/2"	10	12				\$ 2,100
	DW-8228-S-24	Double Face Starter	25 1/4"	28 1/2"	82"	14"	10	12				\$ 3,356
	DW-8228-A-24	Double Face Adder	24 1/4"	28 1/2"	82"	14"	10	12				\$ 2,613
	DW-8220-S-30	Double Face Starter	31 1/4"	19 1/2"	82"	9 1/2"	10	12				\$ 2,575
	DW-8220-A-30	Double Face Adder	30 1/4"	19 1/2"	82"	9 1/2"	10	12				\$ 2,031
	DW-8224-S-30	Double Face Starter	31 1/4"	23 1/2"	82"	11 1/2"	10	12			\$ 2,638	
	DW-8224-A-30	Double Face Adder	30 1/4"	23 1/2"	82"	11 1/2"	10	12			\$ 2,100	
	DW-8228-S-30	Double Face Starter	31 1/4"	28 1/2"	82"	14"	10	12			\$ 3,356	
	DW-8228-A-30	Double Face Adder	30 1/4"	28 1/2"	82"	14"	10	12			\$ 2,613	
	DW-8220-S-36	Double Face Starter	37 1/4"	19 1/2"	82"	9 1/2"	10	12	224 Lbs.	12 Cu Ft	\$ 2,350	
 Model Shown DW-8224-A-36	DW-8220-A-36	Double Face Adder	36 1/4"	19 1/2"	82"	9 1/2"	10	12	184 Lbs.	11 Cu Ft	\$ 1,806	
	DW-8224-S-36	Double Face Starter	37 1/4"	23 1/2"	82"	11 1/2"	10	12	256 Lbs.	14 Cu Ft	\$ 2,413	
	DW-8224-A-36	Double Face Adder	36 1/4"	23 1/2"	82"	11 1/2"	10	12	207 Lbs.	12 Cu Ft	\$ 1,875	
	DW-8228-S-36	Double Face Starter	37 1/4"	28 1/2"	82"	14"	10	12	289 Lbs.	16 Cu Ft	\$ 3,138	
	DW-8228-A-36	Double Face Adder	36 1/4"	28 1/2"	82"	14"	10	12	230 Lbs.	14 Cu Ft	\$ 2,394	

SHELVING

MODEL NUMBER	PRODUCT	WIDTH	DEPTH	HEIGHT	SHELF DEPTH	# OF SHELVES	# OF OPENINGS	WEIGHT	VOLUME	LIST PRICE	DESCRIPTION
DW-9620-S-24	Double Face Starter	25 1/4"	19 1/2"	96"	9 1/2"	12	14			\$ 2,744	End, Mid, Top and Base Panels to be constructed from 1" thick 11-ply solid core, veneered 2 sides. Vertical, top and bottom edges banded with 1/4" external hardwood edging, edges to be eased. Front Edge: 3/4" thick x 2 1/2" high fascia - tongue and grooved to top.
DW-9620-A-24	Double Face Adder	24 1/4"	19 1/2"	96"	9 1/2"	12	14			\$ 2,200	
DW-9624-S-24	Double Face Starter	25 1/4"	23 1/2"	96"	11 1/2"	12	14			\$ 2,819	
DW-9624-A-24	Double Face Adder	24 1/4"	23 1/2"	96"	11 1/2"	12	14			\$ 2,281	
DW-9628-S-24	Double Face Starter	25 1/4"	28 1/2"	96"	14"	12	14			\$ 3,550	
DW-9628-A-24	Double Face Adder	24 1/4"	28 1/2"	96"	14"	12	14			\$ 2,825	
DW-9620-S-30	Double Face Starter	31 1/4"	19 1/2"	96"	9 1/2"	12	14			\$ 2,744	
DW-9620-A-30	Double Face Adder	30 1/4"	19 1/2"	96"	9 1/2"	12	14			\$ 2,200	
DW-9624-S-30	Double Face Starter	31 1/4"	23 1/2"	96"	11 1/2"	12	14			\$ 2,819	
DW-9624-A-30	Double Face Adder	30 1/4"	23 1/2"	96"	11 1/2"	12	14			\$ 2,281	
DW-9628-S-30	Double Face Starter	31 1/4"	28 1/2"	96"	14"	12	14			\$ 3,550	
DW-9628-A-30	Double Face Adder	30 1/4"	28 1/2"	96"	14"	12	14			\$ 2,825	
DW-9620-S-36	Double Face Starter	37 1/4"	19 1/2"	96"	9 1/2"	12	14	276 Lbs.	13 Cu Ft	\$ 2,519	
DW-9620-A-36	Double Face Adder	36 1/4"	19 1/2"	96"	9 1/2"	12	14	220 Lbs.	12 Cu Ft	\$ 1,981	
DW-9624-S-36	Double Face Starter	37 1/4"	23 1/2"	96"	11 1/2"	12	14	315 Lbs.	15 Cu Ft	\$ 2,594	
DW-9624-A-36	Double Face Adder	36 1/4"	23 1/2"	96"	11 1/2"	12	14	247 Lbs.	13 Cu Ft	\$ 2,056	
DW-9628-S-36	Double Face Starter	37 1/4"	28 1/2"	96"	14"	12	14	353 Lbs.	17 Cu Ft	\$ 3,331	
DW-9628-A-36	Double Face Adder	36 1/4"	28 1/2"	96"	14"	12	14	275 Lbs.	15 Cu Ft	\$ 2,600	



Model Shown
DW-9612-S-36



Model Shown
DW-9612-A-36



SHELVING

MODEL NUMBER	PRODUCT	WIDTH	DEPTH	HEIGHT	SHELF DEPTH	# OF SHELVES	# OF OPENINGS	WEIGHT	VOLUME	LIST PRICE	DESCRIPTION
DW-3010-S-24-IPT	Single Face Starter	25 ¹ / ₄ "	10 ¹ / ₈ "	30"	9 ¹ / ₂ "	1	2			\$ 1,200	End, Mid, Top and Base Panels to be constructed from 1" thick 11-ply solid core, veneered 2 sides. Vertical, top and bottom edges banded with 1/4" external hardwood edging, edges to be eased. Front Edge: 3/4" thick x 2 ¹ / ₂ " high fascia - tongue and grooved to top.
DW-3010-A-24-IPT	Single Face Adder	24 ¹ / ₄ "	10 ¹ / ₈ "	30"	9 ¹ / ₂ "	1	2			\$ 919	
DW-3012-S-24-IPT	Single Face Starter	25 ¹ / ₄ "	12 ¹ / ₈ "	30"	11 ¹ / ₂ "	1	2			\$ 2,156	
DW-3012-A-24-IPT	Single Face Adder	24 ¹ / ₄ "	12 ¹ / ₈ "	30"	11 ¹ / ₂ "	1	2			\$ 969	
DW-3010-S-30-IPT	Single Face Starter	31 ¹ / ₄ "	10 ¹ / ₈ "	30"	9 ¹ / ₂ "	1	2			\$ 1,200	
DW-3010-A-30-IPT	Single Face Adder	30 ¹ / ₄ "	10 ¹ / ₈ "	30"	9 ¹ / ₂ "	1	2			\$ 919	
DW-3012-S-30-IPT	Single Face Starter	31 ¹ / ₄ "	12 ¹ / ₈ "	30"	11 ¹ / ₂ "	1	2			\$ 2,156	
DW-3012-A-30-IPT	Single Face Adder	30 ¹ / ₄ "	12 ¹ / ₈ "	30"	11 ¹ / ₂ "	1	2			\$ 969	
DW-3010-S-36-IPT	Single Face Starter	37 ¹ / ₄ "	10 ¹ / ₈ "	30"	9 ¹ / ₂ "	1	2			\$ 1,056	
DW-3010-A-36-IPT	Single Face Adder	36 ¹ / ₄ "	10 ¹ / ₈ "	30"	9 ¹ / ₂ "	1	2			\$ 775	
DW-3012-S-36-IPT	Single Face Starter	37 ¹ / ₄ "	12 ¹ / ₈ "	30"	11 ¹ / ₂ "	1	2			\$ 1,094	
DW-3012-A-36-IPT	Single Face Adder	36 ¹ / ₄ "	12 ¹ / ₈ "	30"	11 ¹ / ₂ "	1	2			\$ 1,113	
DW-3610-S-24-IPT	Single Face Starter	25 ¹ / ₄ "	10 ¹ / ₈ "	36"	9 ¹ / ₂ "	1	2			\$ 1,156	
DW-3610-A-24-IPT	Single Face Adder	24 ¹ / ₄ "	10 ¹ / ₈ "	36"	9 ¹ / ₂ "	1	2			\$ 856	
DW-3612-S-24-IPT	Single Face Starter	25 ¹ / ₄ "	12 ¹ / ₈ "	36"	11 ¹ / ₂ "	1	2			\$ 1,200	
DW-3612-A-24-IPT	Single Face Adder	24 ¹ / ₄ "	12 ¹ / ₈ "	36"	11 ¹ / ₂ "	1	2			\$ 888	
DW-3614-S-24-IPT	Single Face Starter	25 ¹ / ₄ "	14 ⁵ / ₈ "	36"	14"	1	2			\$ 1,331	
DW-3614-A-24-IPT	Single Face Adder	24 ¹ / ₄ "	14 ⁵ / ₈ "	36"	14"	1	2			\$ 988	
DW-3610-S-30-IPT	Single Face Starter	31 ¹ / ₄ "	10 ¹ / ₈ "	36"	9 ¹ / ₂ "	1	2			\$ 1,156	
DW-3610-A-30-IPT	Single Face Adder	30 ¹ / ₄ "	10 ¹ / ₈ "	36"	9 ¹ / ₂ "	1	2			\$ 856	
DW-3612-S-30-IPT	Single Face Starter	31 ¹ / ₄ "	12 ¹ / ₈ "	36"	11 ¹ / ₂ "	1	2			\$ 1,200	
DW-3612-A-30-IPT	Single Face Adder	30 ¹ / ₄ "	12 ¹ / ₈ "	36"	11 ¹ / ₂ "	1	2			\$ 888	
DW-3614-S-30-IPT	Single Face Starter	31 ¹ / ₄ "	14 ⁵ / ₈ "	36"	14"	1	2			\$ 1,331	
DW-3614-A-30-IPT	Single Face Adder	30 ¹ / ₄ "	14 ⁵ / ₈ "	36"	14"	1	2			\$ 988	
DW-3610-S-36-IPT	Single Face Starter	37 ¹ / ₄ "	10 ¹ / ₈ "	36"	9 ¹ / ₂ "	1	2	50.6 Lbs.	4 Cu Ft	\$ 1,013	
DW-3610-A-36-IPT	Single Face Adder	36 ¹ / ₄ "	10 ¹ / ₈ "	36"	9 ¹ / ₂ "	1	2	46 Lbs.	4 Cu Ft	\$ 713	
DW-3612-S-36-IPT	Single Face Starter	37 ¹ / ₄ "	12 ¹ / ₈ "	36"	11 ¹ / ₂ "	1	2	50.6 Lbs.	5 Cu Ft	\$ 1,056	
DW-3612-A-36-IPT	Single Face Adder	36 ¹ / ₄ "	12 ¹ / ₈ "	36"	11 ¹ / ₂ "	1	2	47.2 Lbs.	5 Cu Ft	\$ 738	
DW-3614-S-36-IPT	Single Face Starter	37 ¹ / ₄ "	14 ⁵ / ₈ "	36"	14"	1	2	74.8 Lbs.	6 Cu Ft	\$ 1,181	
DW-3614-A-36-IPT	Single Face Adder	36 ¹ / ₄ "	14 ⁵ / ₈ "	36"	14"	1	2	63.3 Lbs.	6 Cu Ft	\$ 844	

Model Shown
DW-3012-S-36-IPT

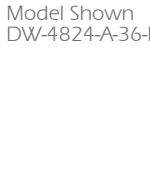

Model Shown
DW-3012-A-36-IPT

	MODEL NUMBER	PRODUCT	WIDTH	DEPTH	HEIGHT	SHELF DEPTH	# OF SHELVES	# OF OPENINGS	WEIGHT	VOLUME	LIST PRICE	DESCRIPTION
 <p>Model Shown DW-4824-S-36-IPT</p>	DW-4210-S-24-IPT	Single Face Starter	25 1/4"	10 1/8"	42"	9 1/2"	2	3			\$ 1,244	End, Mid, Top and Base Panels to be constructed from 1" thick 11-ply solid core, veneered 2 sides. Vertical, top and bottom edges banded with 1/4" external hardwood edging, edges to be eased. Front Edge: 3/4" thick x 2 1/2" high fascia - tongue and grooved to top.
	DW-4210-A-24-IPT	Single Face Adder	24 1/4"	10 1/8"	42"	9 1/2"	2	3			\$ 950	
	DW-4212-S-24-IPT	Single Face Starter	25 1/4"	12 1/8"	42"	11 1/2"	2	3			\$ 1,288	
	DW-4212-A-24-IPT	Single Face Adder	24 1/4"	12 1/8"	42"	11 1/2"	2	3			\$ 975	
	DW-4214-S-24-IPT	Single Face Starter	25 1/4"	14 5/8"	42"	14"	2	3			\$ 1,450	
	DW-4214-A-24-IPT	Single Face Adder	24 1/4"	14 5/8"	42"	14"	2	3			\$ 1,106	
 <p>Model Shown DW-4824-A-36-IPT</p>	DW-4210-S-30-IPT	Single Face Starter	31 1/4"	10 1/8"	42"	9 1/2"	2	3			\$ 1,244	
	DW-4210-A-30-IPT	Single Face Adder	30 1/4"	10 1/8"	42"	9 1/2"	2	3			\$ 950	
	DW-4212-S-30-IPT	Single Face Starter	31 1/4"	12 1/8"	42"	11 1/2"	2	3			\$ 1,288	
	DW-4212-A-30-IPT	Single Face Adder	30 1/4"	12 1/8"	42"	11 1/2"	2	3			\$ 975	
	DW-4214-S-30-IPT	Single Face Starter	31 1/4"	14 5/8"	42"	14"	2	3			\$ 1,450	
	DW-4214-A-30-IPT	Single Face Adder	30 1/4"	14 5/8"	42"	14"	2	3			\$ 1,106	
 <p>Model Shown DW-4824-A-36-IPT</p>	DW-4210-S-36-IPT	Single Face Starter	37 1/4"	10 1/8"	42"	9 1/2"	2	3	55 Lbs.	5 Cu Ft	\$ 1,094	
	DW-4210-A-36-IPT	Single Face Adder	36 1/4"	10 1/8"	42"	9 1/2"	2	3	52 Lbs.	5 Cu Ft	\$ 800	
	DW-4212-S-36-IPT	Single Face Starter	37 1/4"	12 1/8"	42"	11 1/2"	2	3	60 Lbs.	5 Cu Ft	\$ 1,144	
	DW-4212-A-36-IPT	Single Face Adder	36 1/4"	12 1/8"	42"	11 1/2"	2	3	53 Lbs.	5 Cu Ft	\$ 825	
	DW-4214-S-36-IPT	Single Face Starter	37 1/4"	14 5/8"	42"	14"	2	3	79 Lbs.	6 Cu Ft	\$ 1,300	
	DW-4214-A-36-IPT	Single Face Adder	36 1/4"	14 5/8"	42"	14"	2	3	68 Lbs.	6 Cu Ft	\$ 956	
	DW-4810-S-24-IPT	Single Face Starter	25 1/4"	10 1/8"	48"	9 1/2"	2	3			\$ 1,306	
	DW-4810-A-24-IPT	Single Face Adder	24 1/4"	10 1/8"	48"	9 1/2"	2	3			\$ 994	
	DW-4812-S-24-IPT	Single Face Starter	25 1/4"	12 1/8"	48"	11 1/2"	2	3			\$ 1,319	
	DW-4812-A-24-IPT	Single Face Adder	24 1/4"	12 1/8"	48"	11 1/2"	2	3			\$ 994	
	DW-4814-S-24-IPT	Single Face Starter	25 1/4"	14 5/8"	48"	14"	2	3			\$ 1,481	
	DW-4814-A-24-IPT	Single Face Adder	24 1/4"	14 5/8"	48"	14"	2	3			\$ 1,131	
	DW-4810-S-30-IPT	Single Face Starter	31 1/4"	10 1/8"	48"	9 1/2"	2	3			\$ 1,306	
	DW-4810-A-30-IPT	Single Face Adder	30 1/4"	10 1/8"	48"	9 1/2"	2	3			\$ 994	
	DW-4812-S-30-IPT	Single Face Starter	31 1/4"	12 1/8"	48"	11 1/2"	2	3			\$ 1,319	
	DW-4812-A-30-IPT	Single Face Adder	30 1/4"	12 1/8"	48"	11 1/2"	2	3			\$ 994	
	DW-4814-S-30-IPT	Single Face Starter	31 1/4"	14 5/8"	48"	14"	2	3			\$ 1,481	
	DW-4814-A-30-IPT	Single Face Adder	30 1/4"	14 5/8"	48"	14"	2	3			\$ 1,131	
	DW-4810-S-36-IPT	Single Face Starter	37 1/4"	10 1/8"	48"	9 1/2"	2	3	74.8 Lbs.	5 Cu Ft	\$ 1,156	
	DW-4810-A-36-IPT	Single Face Adder	36 1/4"	10 1/8"	48"	9 1/2"	2	3	65.5 Lbs.	5 Cu Ft	\$ 844	
	DW-4812-S-36-IPT	Single Face Starter	37 1/4"	12 1/8"	48"	11 1/2"	2	3	82.8 Lbs.	6 Cu Ft	\$ 1,175	
	DW-4812-A-36-IPT	Single Face Adder	36 1/4"	12 1/8"	48"	11 1/2"	2	3	71.3 Lbs.	6 Cu Ft	\$ 844	
	DW-4814-S-36-IPT	Single Face Starter	37 1/4"	14 5/8"	48"	14"	2	3	108 Lbs.	7 Cu Ft	\$ 1,338	
	DW-4814-A-36-IPT	Single Face Adder	36 1/4"	14 5/8"	48"	14"	2	3	92 Lbs.	7 Cu Ft	\$ 981	

SHELVING

MODEL NUMBER	PRODUCT	WIDTH	DEPTH	HEIGHT	SHELF DEPTH	# OF SHELVES	# OF OPENINGS	WEIGHT	VOLUME	LIST PRICE	DESCRIPTION
DW-6010-S-24-IPT	Single Face Starter	25 1/4"	10 1/8"	60"	9 1/2"	3	4			\$ 1,331	End, Mid, Top and Base Panels to be constructed from 1" thick 11-ply solid core, veneered 2 sides. Vertical, top and bottom edges banded with 1/4" external hardwood edging, edges to be eased. Front Edge: 3/4" thick x 2 1/2" high fascia - tongue and grooved to top.
DW-6010-A-24-IPT	Single Face Adder	24 1/4"	10 1/8"	60"	9 1/2"	3	4			\$ 1,031	
DW-6012-S-24-IPT	Single Face Starter	25 1/4"	12 1/8"	60"	11 1/2"	3	4			\$ 1,375	
DW-6012-A-24-IPT	Single Face Adder	24 1/4"	12 1/8"	60"	11 1/2"	3	4			\$ 1,063	
DW-6014-S-24-IPT	Single Face Starter	25 1/4"	14 5/8"	60"	14"	3	4			\$ 1,563	
DW-6014-A-24-IPT	Single Face Adder	24 1/4"	14 5/8"	60"	14"	3	4			\$ 1,225	
DW-6010-S-30-IPT	Single Face Starter	31 1/4"	10 1/8"	60"	9 1/2"	3	4			\$ 1,331	
DW-6010-A-30-IPT	Single Face Adder	30 1/4"	10 1/8"	60"	9 1/2"	3	4			\$ 1,031	
DW-6012-S-30-IPT	Single Face Starter	31 1/4"	12 1/8"	60"	11 1/2"	3	4			\$ 1,375	
DW-6012-A-30-IPT	Single Face Adder	30 1/4"	12 1/8"	60"	11 1/2"	3	4			\$ 1,063	
DW-6014-S-30-IPT	Single Face Starter	31 1/4"	14 5/8"	60"	14"	3	4			\$ 1,563	
DW-6014-A-30-IPT	Single Face Adder	30 1/4"	14 5/8"	60"	14"	3	4			\$ 125	
DW-6010-S-36-IPT	Single Face Starter	37 1/4"	10 1/8"	60"	9 1/2"	3	4	100 Lbs.	6 Cu Ft	\$ 1,188	
DW-6010-A-36-IPT	Single Face Adder	36 1/4"	10 1/8"	60"	9 1/2"	3	4	86.3 Lbs.	6 Cu Ft	\$ 888	
DW-6012-S-36-IPT	Single Face Starter	37 1/4"	12 1/8"	60"	11 1/2"	3	4	116 Lbs.	8 Cu Ft	\$ 1,231	
DW-6012-A-36-IPT	Single Face Adder	36 1/4"	12 1/8"	60"	11 1/2"	3	4	95.5 Lbs.	7 Cu Ft	\$ 919	
DW-6014-S-36-IPT	Single Face Starter	37 1/4"	14 5/8"	60"	14"	3	4	141 Lbs.	9 Cu Ft	\$ 1,419	
DW-6014-A-36-IPT	Single Face Adder	36 1/4"	14 5/8"	60"	14"	3	4	121 Lbs.	8 Cu Ft	\$ 1,075	







Model Shown
DW-6012-S-36-IPT



Model Shown
DW-6012-A-36-IPT

SHELVING

	MODEL NUMBER	PRODUCT	WIDTH	DEPTH	HEIGHT	SHELF DEPTH	# OF SHELVES	# OF OPENINGS	WEIGHT	VOLUME	LIST PRICE	DESCRIPTION	
	DW-3620-S-24-IPT	Double Face Starter	25 1/4"	19 1/2"	36"	9 1/2"	2	4			\$ 2,063	End, Mid, Top and Base Panels to be constructed from 1" thick 11-ply solid core, veneered 2 sides. Vertical, top and bottom edges banded with 1/4" external hardwood edging, edges to be eased. Front Edge: 3/4" thick x 2 1/2" high fascia - tongue and grooved to top.	
	DW-3620-A-24-IPT	Double Face Adder	24 1/4"	19 1/2"	36"	9 1/2"	2	4			\$ 1,544		
	DW-3624-S-24-IPT	Double Face Starter	25 1/4"	23 1/2"	36"	11 1/2"	2	4			\$ 2,100		
	DW-3624-A-24-IPT	Double Face Adder	24 1/4"	23 1/2"	36"	11 1/2"	2	4			\$ 1,556		
	DW-3628-S-24-IPT	Double Face Starter	25 1/4"	28 1/2"	36"	14"	2	4			\$ 2,394		
	DW-3628-A-24-IPT	Double Face Adder	24 1/4"	28 1/2"	36"	14"	2	4			\$ 1,800		
		DW-3620-S-30-IPT	Double Face Starter	31 1/4"	19 1/2"	36"	9 1/2"	2	4				\$ 2,063
	DW-3620-A-30-IPT	Double Face Adder	30 1/4"	19 1/2"	36"	9 1/2"	2	4			\$ 1,544		
	DW-3624-S-30-IPT	Double Face Starter	31 1/4"	23 1/2"	36"	11 1/2"	2	4			\$ 2,100		
	DW-3624-A-30-IPT	Double Face Adder	30 1/4"	23 1/2"	36"	11 1/2"	2	4			\$ 1,556		
	DW-3628-S-30-IPT	Double Face Starter	31 1/4"	28 1/2"	36"	14"	2	4			\$ 2,394		
	DW-3628-A-30-IPT	Double Face Adder	30 1/4"	28 1/2"	36"	14"	2	4			\$ 1,800		
		DW-3620-S-36-IPT	Double Face Starter	37 1/4"	19 1/2"	36"	9 1/2"	2	4	88.6 Lbs.	7 Cu Ft		\$ 1,844
	DW-3620-A-36-IPT	Double Face Adder	36 1/4"	19 1/2"	36"	9 1/2"	2	4	73.6 Lbs.	6 Cu Ft	\$ 1,319		
	DW-3624-S-36-IPT	Double Face Starter	37 1/4"	23 1/2"	36"	11 1/2"	2	4	110 Lbs.	10 Cu Ft	\$ 1,881		
	DW-3624-A-36-IPT	Double Face Adder	36 1/4"	23 1/2"	36"	11 1/2"	2	4	88.6 Lbs.	9 Cu Ft	\$ 1,338		
	DW-3628-S-36-IPT	Double Face Starter	37 1/4"	28 1/2"	36"	14"	2	4	132 Lbs.	11 Cu Ft	\$ 2,169		
	DW-3628-A-36-IPT	Double Face Adder	36 1/4"	28 1/2"	36"	14"	2	4	104 Lbs.	10 Cu Ft	\$ 1,575		
		DW-4220-S-24-IPT	Double Face Starter	25 1/4"	19 1/2"	42"	9 1/2"	4	6				\$ 2,238
	DW-4220-A-24-IPT	Double Face Adder	24 1/4"	19 1/2"	42"	9 1/2"	4	6			\$ 1,719		
	DW-4224-S-24-IPT	Double Face Starter	25 1/4"	23 1/2"	42"	11 1/2"	4	6			\$ 2,288		
	DW-4224-A-24-IPT	Double Face Adder	24 1/4"	23 1/2"	42"	11 1/2"	4	6			\$ 1,744		
	DW-4228-S-24-IPT	Double Face Starter	25 1/4"	28 1/2"	42"	14"	4	6			\$ 2,638		
	DW-4228-A-24-IPT	Double Face Adder	24 1/4"	28 1/2"	42"	14"	4	6			\$ 2,044		
		DW-4220-S-30-IPT	Double Face Starter	31 1/4"	19 1/2"	42"	9 1/2"	4	6			\$ 2,238	
	DW-4220-A-30-IPT	Double Face Adder	30 1/4"	19 1/2"	42"	9 1/2"	4	6			\$ 1,719		
	DW-4224-S-30-IPT	Double Face Starter	31 1/4"	23 1/2"	42"	11 1/2"	4	6			\$ 2,288		
	DW-4224-A-30-IPT	Double Face Adder	30 1/4"	23 1/2"	42"	11 1/2"	4	6			\$ 1,744		
	DW-4228-S-30-IPT	Double Face Starter	31 1/4"	28 1/2"	42"	14"	4	6			\$ 2,638		
	DW-4228-A-30-IPT	Double Face Adder	30 1/4"	28 1/2"	42"	14"	4	6			\$ 2,044		
		DW-4220-S-36-IPT	Double Face Starter	37 1/4"	19 1/2"	42"	9 1/2"	4	6	94 Lbs.	7 Cu Ft	\$ 2,019	
	DW-4220-A-36-IPT	Double Face Adder	36 1/4"	19 1/2"	42"	9 1/2"	4	6	78 Lbs.	7 Cu Ft	\$ 1,494		
	DW-4224-S-36-IPT	Double Face Starter	37 1/4"	23 1/2"	42"	11 1/2"	4	6	115 Lbs.	10 Cu Ft	\$ 2,063		
DW-4224-A-36-IPT	Double Face Adder	36 1/4"	23 1/2"	42"	11 1/2"	4	6	113 Lbs.	10 Cu Ft	\$ 1,519			
DW-4228-S-36-IPT	Double Face Starter	37 1/4"	28 1/2"	42"	14"	4	6	183 Lbs.	13 Cu Ft	\$ 2,413			
DW-4228-A-36-IPT	Double Face Adder	36 1/4"	28 1/2"	42"	14"	4	6	109 Lbs.	13 Cu Ft	\$ 1,819			

SHELVING

MODEL NUMBER	PRODUCT	WIDTH	DEPTH	HEIGHT	SHELF DEPTH	# OF SHELVES	# OF OPENINGS	WEIGHT	VOLUME	LIST PRICE	DESCRIPTION
--------------	---------	-------	-------	--------	-------------	--------------	---------------	--------	--------	------------	-------------



Model Shown
DW-4824-S-36-IPT

DW-4820-S-24-IPT	Double Face Starter	25 1/4"	19 1/2"	48"	9 1/2"	4	6			\$ 2,313	End, Mid, Top and Base Panels to be constructed from 1" thick 11-ply solid core, veneered 2 sides. Vertical, top and bottom edges banded with 1/4" external hardwood edging, edges to be eased. Front Edge: 3/4" thick x 2 1/2" high fascia - tongue and grooved to top.
DW-4820-A-24-IPT	Double Face Adder	24 1/4"	19 1/2"	48"	9 1/2"	4	6			\$ 1,769	
DW-4824-S-24-IPT	Double Face Starter	25 1/4"	23 1/2"	48"	11 1/2"	4	6			\$ 2,363	
DW-4824-A-24-IPT	Double Face Adder	24 1/4"	23 1/2"	48"	11 1/2"	4	6			\$ 1,794	
DW-4828-S-24-IPT	Double Face Starter	25 1/4"	28 1/2"	48"	14"	4	6			\$ 2,725	
DW-4828-A-24-IPT	Double Face Adder	24 1/4"	28 1/2"	48"	14"	4	6			\$ 2,106	



Model Shown
DW-4824-A-36-IPT

DW-4820-S-30-IPT	Double Face Starter	31 1/4"	19 1/2"	48"	9 1/2"	4	6			\$ 2,313
DW-4820-A-30-IPT	Double Face Adder	30 1/4"	19 1/2"	48"	9 1/2"	4	6			\$ 1,769
DW-4824-S-30-IPT	Double Face Starter	31 1/4"	23 1/2"	48"	11 1/2"	4	6			\$ 2,363
DW-4824-A-30-IPT	Double Face Adder	30 1/4"	23 1/2"	48"	11 1/2"	4	6			\$ 1,794
DW-4828-S-30-IPT	Double Face Starter	31 1/4"	28 1/2"	48"	14"	4	6			\$ 2,725
DW-4828-A-30-IPT	Double Face Adder	30 1/4"	28 1/2"	48"	14"	4	6			\$ 2,106

DW-4820-S-36-IPT	Double Face Starter	37 1/4"	19 1/2"	48"	9 1/2"	4	6	132 Lbs.	9 Cu Ft	\$ 2,088
DW-4820-A-36-IPT	Double Face Adder	36 1/4"	19 1/2"	48"	9 1/2"	4	6	109 Lbs.	8 Cu Ft	\$ 1,550
DW-4824-S-36-IPT	Double Face Starter	37 1/4"	23 1/2"	48"	11 1/2"	4	6	155 Lbs.	11 Cu Ft	\$ 2,138
DW-4824-A-36-IPT	Double Face Adder	36 1/4"	23 1/2"	48"	11 1/2"	4	6	127 Lbs.	10 Cu Ft	\$ 1,575
DW-4828-S-36-IPT	Double Face Starter	37 1/4"	28 1/2"	48"	14"	4	6	178 Lbs.	13 Cu Ft	\$ 2,506
DW-4828-A-36-IPT	Double Face Adder	36 1/4"	28 1/2"	48"	14"	4	6	144 Lbs.	12 Cu Ft	\$ 1,888



Model Shown
DW-6024-S-36-IPT

DW-6020-S-24-IPT	Double Face Starter	25 1/4"	19 1/2"	60"	9 1/2"	6	8			\$ 2,388
DW-6020-A-24-IPT	Double Face Adder	24 1/4"	19 1/2"	60"	9 1/2"	6	8			\$ 1,850
DW-6024-S-24-IPT	Double Face Starter	25 1/4"	23 1/2"	60"	11 1/2"	6	8			\$ 2,438
DW-6024-A-24-IPT	Double Face Adder	24 1/4"	23 1/2"	60"	11 1/2"	6	8			\$ 1,894
DW-6028-S-24-IPT	Double Face Starter	25 1/4"	28 1/2"	60"	14"	6	8			\$ 2,844
DW-6028-A-24-IPT	Double Face Adder	24 1/4"	28 1/2"	60"	14"	6	8			\$ 2,231

DW-6020-S-30-IPT	Double Face Starter	31 1/4"	19 1/2"	60"	9 1/2"	6	8			\$ 2,388
DW-6020-A-30-IPT	Double Face Adder	30 1/4"	19 1/2"	60"	9 1/2"	6	8			\$ 1,850
DW-6024-S-30-IPT	Double Face Starter	31 1/4"	23 1/2"	60"	11 1/2"	6	8			\$ 2,438
DW-6024-A-30-IPT	Double Face Adder	30 1/4"	23 1/2"	60"	11 1/2"	6	8			\$ 1,894
DW-6028-S-30-IPT	Double Face Starter	31 1/4"	28 1/2"	60"	14"	6	8			\$ 2,844
DW-6028-A-30-IPT	Double Face Adder	30 1/4"	28 1/2"	60"	14"	6	8			\$ 2,231



Model Shown
DW-6024-A-36-IPT

DW-6020-S-36-IPT	Double Face Starter	37 1/4"	19 1/2"	60"	9 1/2"	6	8	176 Lbs.	11 Cu Ft	\$ 2,163
DW-6020-A-36-IPT	Double Face Adder	36 1/4"	19 1/2"	60"	9 1/2"	6	8	145 Lbs.	10 Cu Ft	\$ 1,625
DW-6024-S-36-IPT	Double Face Starter	37 1/4"	23 1/2"	60"	11 1/2"	6	8	200 Lbs.	12 Cu Ft	\$ 2,213
DW-6024-A-36-IPT	Double Face Adder	36 1/4"	23 1/2"	60"	11 1/2"	6	8	164 Lbs.	11 Cu Ft	\$ 1,669
DW-6028-S-36-IPT	Double Face Starter	37 1/4"	28 1/2"	60"	14"	6	8	224 Lbs.	13 Cu Ft	\$ 2,619
DW-6028-A-36-IPT	Double Face Adder	36 1/4"	28 1/2"	60"	14"	6	8	184 Lbs.	12 Cu Ft	\$ 2,006

SHELVING

MODEL NUMBER	PRODUCT	WIDTH	DEPTH	HEIGHT	SHELF DEPTH	# OF SHELVES	# OF OPENINGS	WEIGHT	VOLUME	LIST PRICE	DESCRIPTION
DW-9610-S-24-WG	Single Face Starter	25 ¹ / ₄ "	10 ¹ / ₈ "	96"	8 ¹ / ₂ "	6	7			\$ 3,006	End, Mid, Top and Base Panels to be constructed from 1" thick 11-ply solid core, veneered 2 sides. Vertical, top and bottom edges banded with ¹ / ₄ " external hardwood edging, edges to be eased. Front Edge: ³ / ₄ " thick x 2 ¹ / ₂ " high fascia - tongue and grooved to top.
DW-9610-A-24-WG	Single Face Adder	24 ¹ / ₄ "	10 ¹ / ₈ "	96"	8 ¹ / ₂ "	6	7			\$ 2,706	
DW-9612-S-24-WG	Single Face Starter	25 ¹ / ₄ "	12 ¹ / ₈ "	96"	10 ¹ / ₂ "	6	7			\$ 3,075	
DW-9612-A-24-WG	Single Face Adder	24 ¹ / ₄ "	12 ¹ / ₈ "	96"	10 ¹ / ₂ "	6	7			\$ 2,756	
DW-9614-S-24-WG	Single Face Starter	25 ¹ / ₄ "	14 ⁵ / ₈ "	96"	13 ¹ / ₂ "	6	7			\$ 3,331	
DW-9614-A-24-WG	Single Face Adder	24 ¹ / ₄ "	14 ⁵ / ₈ "	96"	13 ¹ / ₂ "	6	7			\$ 2,963	
DW-9610-S-30-WG	Single Face Starter	31 ¹ / ₄ "	10 ¹ / ₈ "	96"	8 ¹ / ₂ "	6	7			\$ 3,006	
DW-9610-A-30-WG	Single Face Adder	30 ¹ / ₄ "	10 ¹ / ₈ "	96"	8 ¹ / ₂ "	6	7			\$ 2,706	
DW-9612-S-30-WG	Single Face Starter	31 ¹ / ₄ "	12 ¹ / ₈ "	96"	10 ¹ / ₂ "	6	7			\$ 3,075	
DW-9612-A-30-WG	Single Face Adder	30 ¹ / ₄ "	12 ¹ / ₈ "	96"	10 ¹ / ₂ "	6	7			\$ 2,756	
DW-9614-S-30-WG	Single Face Starter	31 ¹ / ₄ "	14 ⁵ / ₈ "	96"	13 ¹ / ₂ "	6	7			\$ 3,331	
DW-9614-A-30-WG	Single Face Adder	30 ¹ / ₄ "	14 ⁵ / ₈ "	96"	13 ¹ / ₂ "	6	7			\$ 2,963	
DW-9610-S-36-WG	Single Face Starter	37 ¹ / ₄ "	10 ¹ / ₈ "	96"	8 ¹ / ₂ "	6	7	156 Lbs.	9 Cu Ft	\$ 2,863	
DW-9610-A-36-WG	Single Face Adder	36 ¹ / ₄ "	10 ¹ / ₈ "	96"	8 ¹ / ₂ "	6	7	128 Lbs.	8 Cu Ft	\$ 2,556	
DW-9612-S-36-WG	Single Face Starter	37 ¹ / ₄ "	12 ¹ / ₈ "	96"	10 ¹ / ₂ "	6	7	177 Lbs.	10 Cu Ft	\$ 2,931	
DW-9612-A-36-WG	Single Face Adder	36 ¹ / ₄ "	12 ¹ / ₈ "	96"	10 ¹ / ₂ "	6	7	145 Lbs.	9 Cu Ft	\$ 2,613	
DW-9614-S-36-WG	Single Face Starter	37 ¹ / ₄ "	14 ⁵ / ₈ "	96"	13 ¹ / ₂ "	6	7	213 Lbs.	12 Cu Ft	\$ 3,188	
DW-9614-A-36-WG	Single Face Adder	36 ¹ / ₄ "	14 ⁵ / ₈ "	96"	13 ¹ / ₂ "	6	7	175 Lbs.	11 Cu Ft	\$ 2,819	



Model Shown
DW-9612-S-36-WG



Model Shown
DW-9612-A-36-WG

SHELVING







Model Shown
DW-9624-S-36-WG



Model Shown
DW-9624-A-36-WG

MODEL NUMBER	PRODUCT	WIDTH	DEPTH	HEIGHT	SHELF DEPTH	# OF SHELVES	# OF OPENINGS	WEIGHT	VOLUME	LIST PRICE	DESCRIPTION
DW-9620-S-24-WG	Double Face Starter	25 1/4"	19 1/2"	96"	8 1/2"	12	14			\$ 6,044	End, Mid, Top and Base Panels to be constructed from 1" thick 11-ply solid core, veneered 2 sides. Vertical, top and bottom edges banded with 1/4" external hardwood edging, edges to be eased. Front Edge: 3/4" thick x 2 1/2" high fascia - tongue and grooved to top.
DW-9620-A-24-WG	Double Face Adder	24 1/4"	19 1/2"	96"	8 1/2"	12	14			\$ 5,500	
DW-9624-S-24-WG	Double Face Starter	25 1/4"	23 1/2"	96"	10 1/2"	12	14			\$ 6,113	
DW-9624-A-24-WG	Double Face Adder	24 1/4"	23 1/2"	96"	10 1/2"	12	14			\$ 5,575	
DW-9628-S-24-WG	Double Face Starter	25 1/4"	28 1/2"	96"	13 1/2"	12	14			\$ 6,850	
DW-9628-A-24-WG	Double Face Adder	24 1/4"	28 1/2"	96"	13 1/2"	12	14			\$ 6,125	
DW-9620-S-30-WG	Double Face Starter	31 1/4"	19 1/2"	96"	8 1/2"	12	14			\$ 6,044	
DW-9620-A-30-WG	Double Face Adder	30 1/4"	19 1/2"	96"	8 1/2"	12	14			\$ 5,500	
DW-9624-S-30-WG	Double Face Starter	31 1/4"	23 1/2"	96"	10 1/2"	12	14			\$ 6,113	
DW-9624-A-30-WG	Double Face Adder	30 1/4"	23 1/2"	96"	10 1/2"	12	14			\$ 5,575	
DW-9628-S-30-WG	Double Face Starter	31 1/4"	28 1/2"	96"	13 1/2"	12	14			\$ 6,850	
DW-9628-A-30-WG	Double Face Adder	30 1/4"	28 1/2"	96"	13 1/2"	12	14			\$ 6,125	
DW-9620-S-36-WG	Double Face Starter	37 1/4"	19 1/2"	96"	8 1/2"	12	14	276 Lbs.	13 Cu Ft	\$ 5,819	
DW-9620-A-36-WG	Double Face Adder	36 1/4"	19 1/2"	96"	8 1/2"	12	14	220 Lbs.	12 Cu Ft	\$ 5,275	
DW-9624-S-36-WG	Double Face Starter	37 1/4"	23 1/2"	96"	10 1/2"	12	14	315 Lbs.	15 Cu Ft	\$ 5,894	
DW-9624-A-36-WG	Double Face Adder	36 1/4"	23 1/2"	96"	10 1/2"	12	14	247 Lbs.	13 Cu Ft	\$ 5,356	
DW-9628-S-36-WG	Double Face Starter	37 1/4"	28 1/2"	96"	13 1/2"	12	14	353 Lbs.	17 Cu Ft	\$ 6,631	
DW-9628-A-36-WG	Double Face Adder	36 1/4"	28 1/2"	96"	13 1/2"	12	14	275 Lbs.	15 Cu Ft	\$ 5,900	

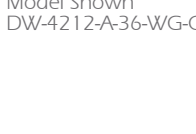
MODEL NUMBER	PRODUCT	WIDTH	DEPTH	HEIGHT	SHELF DEPTH	# OF SHELVES	# OF OPENINGS	WEIGHT	VOLUME	LIST PRICE	DESCRIPTION
 Model Shown DW-3612-S-36-WG-G	DW-3610-S-24-WG-G Single Face Starter	25 1/4"	10 1/8"	36"	8 1/2"	1	2			\$ 2,050	End, Mid, Top and Base Panels to be constructed from 1" thick 11-ply solid core, veneered 2 sides. Vertical, top and bottom edges banded with 1/4" external hardwood edging, edges to be eased. Front Edge: 3/4" thick x 2 1/2" high fascia - tongue and grooved to top.
	DW-3610-A-24-WG-G Single Face Adder	24 1/4"	10 1/8"	36"	8 1/2"	1	2			\$ 1,750	
	DW-3612-S-24-WG-G Single Face Starter	25 1/4"	12 1/8"	36"	10 1/2"	1	2			\$ 2,100	
	DW-3612-A-24-WG-G Single Face Adder	24 1/4"	12 1/8"	36"	10 1/2"	1	2			\$ 1,788	
	DW-3614-S-24-WG-G Single Face Starter	25 1/4"	14 5/8"	36"	13 1/2"	1	2			\$ 2,250	
	DW-3614-A-24-WG-G Single Face Adder	24 1/4"	14 5/8"	36"	13 1/2"	1	2			\$ 1,906	
 Model Shown DW-3612-A-36-WG-G	DW-3610-S-30-WG-G Single Face Starter	31 1/4"	10 1/8"	36"	8 1/2"	1	2			\$ 2,050	
	DW-3610-A-30-WG-G Single Face Adder	30 1/4"	10 1/8"	36"	8 1/2"	1	2			\$ 1,750	
	DW-3612-S-30-WG-G Single Face Starter	31 1/4"	12 1/8"	36"	10 1/2"	1	2			\$ 2,100	
	DW-3612-A-30-WG-G Single Face Adder	30 1/4"	12 1/8"	36"	10 1/2"	1	2			\$ 1,788	
	DW-3614-S-30-WG-G Single Face Starter	31 1/4"	14 5/8"	36"	13 1/2"	1	2			\$ 2,250	
	DW-3614-A-30-WG-G Single Face Adder	30 1/4"	14 5/8"	36"	13 1/2"	1	2			\$ 1,906	
	DW-3610-S-36-WG-G Single Face Starter	37 1/4"	10 1/8"	36"	8 1/2"	1	2	50.6 Lbs.	4 Cu Ft	\$ 1,906	
	DW-3610-A-36-WG-G Single Face Adder	36 1/4"	10 1/8"	36"	8 1/2"	1	2	46 Lbs.	4 Cu Ft	\$ 1,606	
	DW-3612-S-36-WG-G Single Face Starter	37 1/4"	12 1/8"	36"	10 1/2"	1	2	50.6 Lbs.	5 Cu Ft	\$ 1,956	
	DW-3612-A-36-WG-G Single Face Adder	36 1/4"	12 1/8"	36"	10 1/2"	1	2	47.2 Lbs.	5 Cu Ft	\$ 1,638	
	DW-3614-S-36-WG-G Single Face Starter	37 1/4"	14 5/8"	36"	13 1/2"	1	2	74.8 Lbs.	6 Cu Ft	\$ 2,100	
	DW-3614-A-36-WG-G Single Face Adder	36 1/4"	14 5/8"	36"	13 1/2"	1	2	63.3 Lbs.	6 Cu Ft	\$ 1,763	
 Model Shown DW-4212-S-36-WG-G	DW-4210-S-24-WG-G Single Face Starter	25 1/4"	10 1/8"	42"	8 1/2"	2	3			\$ 2,169	
	DW-4210-A-24-WG-G Single Face Adder	24 1/4"	10 1/8"	42"	8 1/2"	2	3			\$ 1,875	
	DW-4212-S-24-WG-G Single Face Starter	25 1/4"	12 1/8"	42"	10 1/2"	2	3			\$ 2,225	
	DW-4212-A-24-WG-G Single Face Adder	24 1/4"	12 1/8"	42"	10 1/2"	2	3			\$ 1,913	
	DW-4214-S-24-WG-G Single Face Starter	25 1/4"	14 5/8"	42"	13 1/2"	2	3			\$ 2,425	
	DW-4214-A-24-WG-G Single Face Adder	24 1/4"	14 5/8"	42"	13 1/2"	2	3			\$ 2,081	
 Model Shown DW-4212-A-36-WG-G	DW-4210-S-30-WG-G Single Face Starter	31 1/4"	10 1/8"	42"	8 1/2"	2	3			\$ 2,169	
	DW-4210-A-30-WG-G Single Face Adder	30 1/4"	10 1/8"	42"	8 1/2"	2	3			\$ 1,875	
	DW-4212-S-30-WG-G Single Face Starter	31 1/4"	12 1/8"	42"	10 1/2"	2	3			\$ 2,225	
	DW-4212-A-30-WG-G Single Face Adder	30 1/4"	12 1/8"	42"	10 1/2"	2	3			\$ 1,913	
	DW-4214-S-30-WG-G Single Face Starter	31 1/4"	14 5/8"	42"	13 1/2"	2	3			\$ 2,425	
	DW-4214-A-30-WG-G Single Face Adder	30 1/4"	14 5/8"	42"	13 1/2"	2	3			\$ 2,081	
 Model Shown DW-4212-A-36-WG-G	DW-4210-S-36-WG-G Single Face Starter	37 1/4"	10 1/8"	42"	8 1/2"	2	3	55 Lbs.	5 Cu Ft	\$ 2,019	
	DW-4210-A-36-WG-G Single Face Adder	36 1/4"	10 1/8"	42"	8 1/2"	2	3	52 Lbs.	5 Cu Ft	\$ 1,725	
	DW-4212-S-36-WG-G Single Face Starter	37 1/4"	12 1/8"	42"	10 1/2"	2	3	60 Lbs.	5 Cu Ft	\$ 2,081	
	DW-4212-A-36-WG-G Single Face Adder	36 1/4"	12 1/8"	42"	10 1/2"	2	3	53 Lbs.	5 Cu Ft	\$ 1,763	
	DW-4214-S-36-WG-G Single Face Starter	37 1/4"	14 5/8"	42"	13 1/2"	2	3	79 Lbs.	6 Cu Ft	\$ 2,275	
	DW-4214-A-36-WG-G Single Face Adder	36 1/4"	14 5/8"	42"	13 1/2"	2	3	68 Lbs.	6 Cu Ft	\$ 1,931	



Model Shown
DW-7212-S-36-WG-G



Model Shown
DW-7212-A-36-WG-G



Model Shown
DW-8212-S-36-WG-G



Model Shown
DW-8212-A-36-WG-G

MODEL NUMBER	PRODUCT	WIDTH	DEPTH	HEIGHT	SHELF DEPTH	# OF SHELVES	# OF OPENINGS	WEIGHT	VOLUME	LIST PRICE	DESCRIPTION
DW-7210-S-24-WG-G	Single Face Starter	25 1/4"	10 1/8"	72"	8 1/2"	4	5			\$ 2,969	End, Mid, Top and Base Panels to be constructed from 1" thick 11-ply solid core, veneered 2 sides. Vertical, top and bottom edges banded with 1/4" external hardwood edging, edges to be eased. Front Edge: 3/4" thick x 2 1/2" high fascia - tongue and grooved to top.
DW-7210-A-24-WG-G	Single Face Adder	24 1/4"	10 1/8"	72"	8 1/2"	4	5			\$ 2,663	
DW-7212-S-24-WG-G	Single Face Starter	25 1/4"	12 1/8"	72"	10 1/2"	4	5			\$ 3,044	
DW-7212-A-24-WG-G	Single Face Adder	24 1/4"	12 1/8"	72"	10 1/2"	4	5			\$ 2,731	
DW-7214-S-24-WG-G	Single Face Starter	25 1/4"	14 5/8"	72"	13 1/2"	4	5			\$ 3,313	
DW-7214-A-24-WG-G	Single Face Adder	24 1/4"	14 5/8"	72"	13 1/2"	4	5			\$ 2,981	
DW-7210-S-30-WG-G	Single Face Starter	31 1/4"	10 1/8"	72"	8 1/2"	4	5			\$ 2,969	
DW-7210-A-30-WG-G	Single Face Adder	30 1/4"	10 1/8"	72"	8 1/2"	4	5			\$ 2,663	
DW-7212-S-30-WG-G	Single Face Starter	31 1/4"	12 1/8"	72"	10 1/2"	4	5			\$ 3,044	
DW-7212-A-30-WG-G	Single Face Adder	30 1/4"	12 1/8"	72"	10 1/2"	4	5			\$ 2,731	
DW-7214-S-30-WG-G	Single Face Starter	31 1/4"	14 5/8"	72"	13 1/2"	4	5			\$ 3,313	
DW-7214-A-30-WG-G	Single Face Adder	30 1/4"	14 5/8"	72"	13 1/2"	4	5			\$ 2,981	
DW-7210-S-36-WG-G	Single Face Starter	37 1/4"	10 1/8"	72"	8 1/2"	4	5	115 Lbs.	7 Cu Ft	\$ 2,819	
DW-7210-A-36-WG-G	Single Face Adder	36 1/4"	10 1/8"	72"	8 1/2"	4	5	96.6 Lbs.	7 Cu Ft	\$ 2,513	
DW-7212-S-36-WG-G	Single Face Starter	37 1/4"	12 1/8"	72"	10 1/2"	4	5	131 Lbs.	8 Cu Ft	\$ 2,900	
DW-7212-A-36-WG-G	Single Face Adder	36 1/4"	12 1/8"	72"	10 1/2"	4	5	109 Lbs.	8 Cu Ft	\$ 2,581	
DW-7214-S-36-WG-G	Single Face Starter	37 1/4"	14 5/8"	72"	13 1/2"	4	5	159 Lbs.	10 Cu Ft	\$ 3,163	
DW-7214-A-36-WG-G	Single Face Adder	36 1/4"	14 5/8"	72"	13 1/2"	4	5	132 Lbs.	9 Cu Ft	\$ 2,831	
DW-8210-S-24-WG-G	Single Face Starter	25 1/4"	10 1/8"	82"	8 1/2"	5	6			\$ 3,088	
DW-8210-A-24-WG-G	Single Face Adder	24 1/4"	10 1/8"	82"	8 1/2"	5	6			\$ 2,781	
DW-8212-S-24-WG-G	Single Face Starter	25 1/4"	12 1/8"	82"	10 1/2"	5	6			\$ 3,169	
DW-8212-A-24-WG-G	Single Face Adder	24 1/4"	12 1/8"	82"	10 1/2"	5	6			\$ 2,856	
DW-8214-S-24-WG-G	Single Face Starter	25 1/4"	14 5/8"	82"	13 1/2"	5	6			\$ 3,438	
DW-8214-A-24-WG-G	Single Face Adder	24 1/4"	14 5/8"	82"	13 1/2"	5	6			\$ 3,156	
DW-8210-S-30-WG-G	Single Face Starter	31 1/4"	10 1/8"	82"	8 1/2"	5	6			\$ 3,088	
DW-8210-A-30-WG-G	Single Face Adder	30 1/4"	10 1/8"	82"	8 1/2"	5	6			\$ 2,781	
DW-8212-S-30-WG-G	Single Face Starter	31 1/4"	12 1/8"	82"	10 1/2"	5	6			\$ 3,169	
DW-8212-A-30-WG-G	Single Face Adder	30 1/4"	12 1/8"	82"	10 1/2"	5	6			\$ 2,856	
DW-8214-S-30-WG-G	Single Face Starter	31 1/4"	14 5/8"	82"	13 1/2"	5	6			\$ 3,438	
DW-8214-A-30-WG-G	Single Face Adder	30 1/4"	14 5/8"	82"	13 1/2"	5	6			\$ 3,156	
DW-8210-S-36-WG-G	Single Face Starter	37 1/4"	10 1/8"	82"	8 1/2"	5	6	129 Lbs.	8 Cu Ft	\$ 2,938	
DW-8210-A-36-WG-G	Single Face Adder	36 1/4"	10 1/8"	82"	8 1/2"	5	6	107 Lbs.	7 Cu Ft	\$ 2,638	
DW-8212-S-36-WG-G	Single Face Starter	37 1/4"	12 1/8"	82"	10 1/2"	5	6	145 Lbs.	9 Cu Ft	\$ 3,025	
DW-8212-A-36-WG-G	Single Face Adder	36 1/4"	12 1/8"	82"	10 1/2"	5	6	122 Lbs.	8 Cu Ft	\$ 2,706	
DW-8214-S-36-WG-G	Single Face Starter	37 1/4"	14 5/8"	82"	13 1/2"	5	6	175 Lbs.	11 Cu Ft	\$ 3,288	
DW-8214-A-36-WG-G	Single Face Adder	36 1/4"	14 5/8"	82"	13 1/2"	5	6	143 Lbs.	10 Cu Ft	\$ 3,013	

SHELVING

MODEL NUMBER	PRODUCT	WIDTH	DEPTH	HEIGHT	SHELF DEPTH	# OF SHELVES	# OF OPENINGS	WEIGHT	VOLUME	LIST PRICE	DESCRIPTION
DW-9610-S-24-WG-G	Single Face Starter	25 1/4"	10 1/8"	96"	8 1/2"	6	7			\$ 3,194	End, Mid, Top and Base Panels to be constructed from 1" thick 11-ply solid core, veneered 2 sides. Vertical, top and bottom edges banded with 1/4" external hardwood edging, edges to be eased. Front Edge: 3/4" thick x 2 1/2" high fascia - tongue and grooved to top.
DW-9610-A-24-WG-G	Single Face Adder	24 1/4"	10 1/8"	96"	8 1/2"	6	7			\$ 2,894	
DW-9612-S-24-WG-G	Single Face Starter	25 1/4"	12 1/8"	96"	10 1/2"	6	7			\$ 3,300	
DW-9612-A-24-WG-G	Single Face Adder	24 1/4"	12 1/8"	96"	10 1/2"	6	7			\$ 2,981	
DW-9614-S-24-WG-G	Single Face Starter	25 1/4"	14 5/8"	96"	13 1/2"	6	7			\$ 3,669	
DW-9614-A-24-WG-G	Single Face Adder	24 1/4"	14 5/8"	96"	13 1/2"	6	7			\$ 3,300	
DW-9610-S-30-WG-G	Single Face Starter	31 1/4"	10 1/8"	96"	8 1/2"	6	7			\$ 3,194	
DW-9610-A-30-WG-G	Single Face Adder	30 1/4"	10 1/8"	96"	8 1/2"	6	7			\$ 2,894	
DW-9612-S-30-WG-G	Single Face Starter	31 1/4"	12 1/8"	96"	10 1/2"	6	7			\$ 3,300	
DW-9612-A-30-WG-G	Single Face Adder	30 1/4"	12 1/8"	96"	10 1/2"	6	7			\$ 2,981	
DW-9614-S-30-WG-G	Single Face Starter	31 1/4"	14 5/8"	96"	13 1/2"	6	7			\$ 3,669	
DW-9614-A-30-WG-G	Single Face Adder	30 1/4"	14 5/8"	96"	13 1/2"	6	7			\$ 3,300	
DW-9610-S-36-WG-G	Single Face Starter	37 1/4"	10 1/8"	96"	8 1/2"	6	7	156 Lbs.	9 Cu Ft	\$ 3,050	
DW-9610-A-36-WG-G	Single Face Adder	36 1/4"	10 1/8"	96"	8 1/2"	6	7	128 Lbs.	8 Cu Ft	\$ 2,744	
DW-9612-S-36-WG-G	Single Face Starter	37 1/4"	12 1/8"	96"	10 1/2"	6	7	177 Lbs.	10 Cu Ft	\$ 3,156	
DW-9612-A-36-WG-G	Single Face Adder	36 1/4"	12 1/8"	96"	10 1/2"	6	7	145 Lbs.	9 Cu Ft	\$ 2,838	
DW-9614-S-36-WG-G	Single Face Starter	37 1/4"	14 5/8"	96"	13 1/2"	6	7	213 Lbs.	12 Cu Ft	\$ 3,525	
DW-9614-A-36-WG-G	Single Face Adder	36 1/4"	14 5/8"	96"	13 1/2"	6	7	175 Lbs.	11 Cu Ft	\$ 3,156	







Model Shown
DW-9612-S-36-WG-G

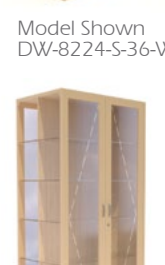

Model Shown
DW-9612-A-36-WG-G

SHELVING

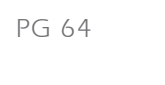
	MODEL NUMBER	PRODUCT	WIDTH	DEPTH	HEIGHT	SHELF DEPTH	# OF SHELVES	# OF OPENINGS	WEIGHT	VOLUME	LIST PRICE	DESCRIPTION
 Model Shown DW-7224-S-36-WG-G	DW-7220-S-24-WG-G	Double Face Starter	25 1/4"	19 1/2"	72"	8 1/2"	8	10			\$ 5,963	End, Mid, Top and Base Panels to be constructed from 1" thick 11-ply solid core, veneered 2 sides. Vertical, top and bottom edges banded with 1/4" external hardwood edging, edges to be eased. Front Edge: 3/4" thick x 2 1/2" high fascia - tongue and grooved to top.
	DW-7220-A-24-WG-G	Double Face Adder	24 1/4"	19 1/2"	72"	8 1/2"	8	10			\$ 5,413	
	DW-7224-S-24-WG-G	Double Face Starter	25 1/4"	23 1/2"	72"	10 1/2"	8	10			\$ 6,063	
	DW-7224-A-24-WG-G	Double Face Adder	24 1/4"	23 1/2"	72"	10 1/2"	8	10			\$ 5,513	
	DW-7228-S-24-WG-G	Double Face Starter	25 1/4"	28 1/2"	72"	13 1/2"	8	10			\$ 6,638	
	DW-7228-A-24-WG-G	Double Face Adder	24 1/4"	28 1/2"	72"	13 1/2"	8	10			\$ 6,038	
 Model Shown DW-7224-S-36-WG-G	DW-7220-S-30-WG-G	Double Face Starter	31 1/4"	19 1/2"	72"	8 1/2"	8	10			\$ 5,963	
	DW-7220-A-30-WG-G	Double Face Adder	30 1/4"	19 1/2"	72"	8 1/2"	8	10			\$ 5,413	
	DW-7224-S-30-WG-G	Double Face Starter	31 1/4"	23 1/2"	72"	10 1/2"	8	10			\$ 6,063	
	DW-7224-A-30-WG-G	Double Face Adder	30 1/4"	23 1/2"	72"	10 1/2"	8	10			\$ 5,513	
	DW-7228-S-30-WG-G	Double Face Starter	31 1/4"	28 1/2"	72"	13 1/2"	8	10			\$ 6,638	
	DW-7228-A-30-WG-G	Double Face Adder	30 1/4"	28 1/2"	72"	13 1/2"	8	10			\$ 6,038	
 Model Shown DW-7224-A-36-WG-G	DW-7220-S-36-WG-G	Double Face Starter	37 1/4"	19 1/2"	72"	8 1/2"	8	10	200 Lbs.	12 Cu Ft	\$ 5,738	
	DW-7220-A-36-WG-G	Double Face Adder	36 1/4"	19 1/2"	72"	8 1/2"	8	10	164 Lbs.	11 Cu Ft	\$ 5,194	
	DW-7224-S-36-WG-G	Double Face Starter	37 1/4"	23 1/2"	72"	10 1/2"	8	10	229 Lbs.	13 Cu Ft	\$ 5,838	
	DW-7224-A-36-WG-G	Double Face Adder	36 1/4"	23 1/2"	72"	10 1/2"	8	10	186 Lbs.	12 Cu Ft	\$ 5,294	
	DW-7228-S-36-WG-G	Double Face Starter	37 1/4"	28 1/2"	72"	13 1/2"	8	10	256 Lbs.	14 Cu Ft	\$ 6,419	
	DW-7228-A-36-WG-G	Double Face Adder	36 1/4"	28 1/2"	72"	13 1/2"	8	10	207 Lbs.	13 Cu Ft	\$ 5,813	
 Model Shown DW-8224-S-36-WG-G	DW-8220-S-24-WG-G	Double Face Starter	25 1/4"	19 1/2"	82"	8 1/2"	10	12			\$ 6,188	
	DW-8220-A-24-WG-G	Double Face Adder	24 1/4"	19 1/2"	82"	8 1/2"	10	12			\$ 5,631	
	DW-8224-S-24-WG-G	Double Face Starter	25 1/4"	23 1/2"	82"	10 1/2"	10	12			\$ 6,313	
	DW-8224-A-24-WG-G	Double Face Adder	24 1/4"	23 1/2"	82"	10 1/2"	10	12			\$ 5,775	
	DW-8228-S-24-WG-G	Double Face Starter	25 1/4"	28 1/2"	82"	13 1/2"	10	12			\$ 7,219	
	DW-8228-A-24-WG-G	Double Face Adder	24 1/4"	28 1/2"	82"	13 1/2"	10	12			\$ 6,475	
 Model Shown DW-8224-A-36-WG-G	DW-8220-S-30-WG-G	Double Face Starter	31 1/4"	19 1/2"	82"	8 1/2"	10	12			\$ 6,188	
	DW-8220-A-30-WG-G	Double Face Adder	30 1/4"	19 1/2"	82"	8 1/2"	10	12			\$ 5,631	
	DW-8224-S-30-WG-G	Double Face Starter	31 1/4"	23 1/2"	82"	10 1/2"	10	12			\$ 6,313	
	DW-8224-A-30-WG-G	Double Face Adder	30 1/4"	23 1/2"	82"	10 1/2"	10	12			\$ 5,775	
	DW-8228-S-30-WG-G	Double Face Starter	31 1/4"	28 1/2"	82"	13 1/2"	10	12			\$ 7,219	
	DW-8228-A-30-WG-G	Double Face Adder	30 1/4"	28 1/2"	82"	13 1/2"	10	12			\$ 6,475	
 Model Shown DW-8224-A-36-WG-G	DW-8220-S-36-WG-G	Double Face Starter	37 1/4"	19 1/2"	82"	8 1/2"	10	12	224 Lbs.	12 Cu Ft	\$ 5,963	
	DW-8220-A-36-WG-G	Double Face Adder	36 1/4"	19 1/2"	82"	8 1/2"	10	12	184 Lbs.	11 Cu Ft	\$ 5,419	
	DW-8224-S-36-WG-G	Double Face Starter	37 1/4"	23 1/2"	82"	10 1/2"	10	12	256 Lbs.	14 Cu Ft	\$ 6,113	
	DW-8224-A-36-WG-G	Double Face Adder	36 1/4"	23 1/2"	82"	10 1/2"	10	12	207 Lbs.	12 Cu Ft	\$ 5,550	
	DW-8228-S-36-WG-G	Double Face Starter	37 1/4"	28 1/2"	82"	13 1/2"	10	12	289 Lbs.	16 Cu Ft	\$ 6,994	
	DW-8228-A-36-WG-G	Double Face Adder	36 1/4"	28 1/2"	82"	13 1/2"	10	12	230 Lbs.	14 Cu Ft	\$ 6,250	

	MODEL NUMBER	PRODUCT	WIDTH	DEPTH	HEIGHT	SHELF DEPTH	# OF SHELVES	# OF OPENINGS	WEIGHT	VOLUME	LIST PRICE	DESCRIPTION
	DW-9620-S-24-WG-G	Double Face Starter	25 1/4"	19 1/2"	96"	8 1/2"	12	14			\$ 6,738	End, Mid, Top and Base Panels to be constructed from 1" thick 11-ply solid core, veneered 2 sides. Vertical, top and bottom edges banded with 1/4" external hardwood edging, edges to be eased. Front Edge: 3/4" thick x 2 1/2" high fascia - tongue and grooved to top.
	DW-9620-A-24-WG-G	Double Face Adder	24 1/4"	19 1/2"	96"	8 1/2"	12	14			\$ 6,169	
	DW-9624-S-24-WG-G	Double Face Starter	25 1/4"	23 1/2"	96"	10 1/2"	12	14			\$ 7,025	
	DW-9624-A-24-WG-G	Double Face Adder	24 1/4"	23 1/2"	96"	10 1/2"	12	14			\$ 6,463	
	DW-9628-S-24-WG-G	Double Face Starter	25 1/4"	28 1/2"	96"	13 1/2"	12	14			\$ 7,906	
	DW-9628-A-24-WG-G	Double Face Adder	24 1/4"	28 1/2"	96"	13 1/2"	12	14			\$ 7,138	
	DW-9620-S-30-WG-G	Double Face Starter	31 1/4"	19 1/2"	96"	8 1/2"	12	14			\$ 6,738	
	DW-9620-A-30-WG-G	Double Face Adder	30 1/4"	19 1/2"	96"	8 1/2"	12	14			\$ 6,169	
	DW-9624-S-30-WG-G	Double Face Starter	31 1/4"	23 1/2"	96"	10 1/2"	12	14			\$ 7,025	
	DW-9624-A-30-WG-G	Double Face Adder	30 1/4"	23 1/2"	96"	10 1/2"	12	14			\$ 6,463	
	DW-9628-S-30-WG-G	Double Face Starter	31 1/4"	28 1/2"	96"	13 1/2"	12	14			\$ 7,906	
	DW-9628-A-30-WG-G	Double Face Adder	30 1/4"	28 1/2"	96"	13 1/2"	12	14			\$ 7,138	
	DW-9620-S-36-WG-G	Double Face Starter	37 1/4"	19 1/2"	96"	8 1/2"	12	14	276 Lbs.	13 Cu Ft	\$ 6,419	
	DW-9620-A-36-WG-G	Double Face Adder	36 1/4"	19 1/2"	96"	8 1/2"	12	14	220 Lbs.	12 Cu Ft	\$ 5,875	
	DW-9624-S-36-WG-G	Double Face Starter	37 1/4"	23 1/2"	96"	10 1/2"	12	14	315 Lbs.	15 Cu Ft	\$ 6,688	
	DW-9624-A-36-WG-G	Double Face Adder	36 1/4"	23 1/2"	96"	10 1/2"	12	14	247 Lbs.	13 Cu Ft	\$ 6,025	
	DW-9628-S-36-WG-G	Double Face Starter	37 1/4"	28 1/2"	96"	13 1/2"	12	14	353 Lbs.	17 Cu Ft	\$ 7,525	
	DW-9628-A-36-WG-G	Double Face Adder	36 1/4"	28 1/2"	96"	13 1/2"	12	14	275 Lbs.	15 Cu Ft	\$ 6,800	

Model Shown
DW-9624-S-36-WG-G

Model Shown
DW-9624-A-36-WG-G

MODEL NUMBER	PRODUCT	WIDTH	DEPTH	HEIGHT	SHELF DEPTH	# OF SHELVES	# OF OPENINGS	WEIGHT	VOLUME	LIST PRICE	DESCRIPTION
DW-9610-S-24-WH	Single Face Starter	25 1/4"	10 1/8"	96"	8 1/2"	6	7			\$ 2,644	End, Mid, Top and Base Panels to be constructed from 1" thick 11-ply solid core, veneered 2 sides. Vertical, top and bottom edges banded with 1/4" external hardwood edging, edges to be eased. Front Edge: 3/4" thick x 2 1/2" high fascia - tongue and grooved to top.
DW-9610-A-24-WH	Single Face Adder	24 1/4"	10 1/8"	96"	8 1/2"	6	7			\$ 2,344	
DW-9612-S-24-WH	Single Face Starter	25 1/4"	12 1/8"	96"	10 1/2"	6	7			\$ 2,719	
DW-9612-A-24-WH	Single Face Adder	24 1/4"	12 1/8"	96"	10 1/2"	6	7			\$ 2,400	
DW-9614-S-24-WH	Single Face Starter	25 1/4"	14 5/8"	96"	13 1/2"	6	7			\$ 2,975	
DW-9614-A-24-WH	Single Face Adder	24 1/4"	14 5/8"	96"	13 1/2"	6	7			\$ 2,606	
DW-9610-S-30-WH	Single Face Starter	31 1/4"	10 1/8"	96"	8 1/2"	6	7			\$ 2,644	
DW-9610-A-30-WH	Single Face Adder	30 1/4"	10 1/8"	96"	8 1/2"	6	7			\$ 2,344	
DW-9612-S-30-WH	Single Face Starter	31 1/4"	12 1/8"	96"	10 1/2"	6	7			\$ 2,719	
DW-9612-A-30-WH	Single Face Adder	30 1/4"	12 1/8"	96"	10 1/2"	6	7			\$ 2,400	
DW-9614-S-30-WH	Single Face Starter	31 1/4"	14 5/8"	96"	13 1/2"	6	7			\$ 2,975	
DW-9614-A-30-WH	Single Face Adder	30 1/4"	14 5/8"	96"	13 1/2"	6	7			\$ 2,606	
DW-9610-S-36-WH	Single Face Starter	37 1/4"	10 1/8"	96"	8 1/2"	6	7	156 Lbs.	9 Cu Ft	\$ 2,500	
DW-9610-A-36-WH	Single Face Adder	36 1/4"	10 1/8"	96"	8 1/2"	6	7	128 Lbs.	8 Cu Ft	\$ 2,200	
DW-9612-S-36-WH	Single Face Starter	37 1/4"	12 1/8"	96"	10 1/2"	6	7	177 Lbs.	10 Cu Ft	\$ 2,569	
DW-9612-A-36-WH	Single Face Adder	36 1/4"	12 1/8"	96"	10 1/2"	6	7	145 Lbs.	9 Cu Ft	\$ 2,250	
DW-9614-S-36-WH	Single Face Starter	37 1/4"	14 5/8"	96"	13 1/2"	6	7	213 Lbs.	12 Cu Ft	\$ 2,825	
DW-9614-A-36-WH	Single Face Adder	36 1/4"	14 5/8"	96"	13 1/2"	6	7	175 Lbs.	11 Cu Ft	\$ 2,456	



Model Shown
DW-9612-S-36-WH



Model Shown
DW-9612-A-36-WH

SHELVING

MODEL NUMBER	PRODUCT	WIDTH	DEPTH	HEIGHT	SHELF DEPTH	# OF SHELVES	# OF OPENINGS	WEIGHT	VOLUME	LIST PRICE	DESCRIPTION
DW-9620-S-24-WH	Double Face Starter	25 ¹ / ₄ "	19 ¹ / ₂ "	96"	8 ¹ / ₂ "	12	14			\$ 5,025	End, Mid, Top and Base Panels to be constructed from 1" thick 11-ply solid core, veneered 2 sides. Vertical, top and bottom edges banded with 1/4" external hardwood edging, edges to be eased. Front Edge: 3/4" thick x 2 1/2" high fascia - tongue and grooved to top.
DW-9620-A-24-WH	Double Face Adder	24 ¹ / ₄ "	19 ¹ / ₂ "	96"	8 ¹ / ₂ "	12	14			\$ 4,481	
DW-9624-S-24-WH	Double Face Starter	25 ¹ / ₄ "	23 ¹ / ₂ "	96"	10 ¹ / ₂ "	12	14			\$ 5,094	
DW-9624-A-24-WH	Double Face Adder	24 ¹ / ₄ "	23 ¹ / ₂ "	96"	10 ¹ / ₂ "	12	14			\$ 4,556	
DW-9628-S-24-WH	Double Face Starter	25 ¹ / ₄ "	28 ¹ / ₂ "	96"	13 ¹ / ₂ "	12	14			\$ 5,831	
DW-9628-A-24-WH	Double Face Adder	24 ¹ / ₄ "	28 ¹ / ₂ "	96"	13 ¹ / ₂ "	12	14			\$ 5,100	
DW-9620-S-30-WH	Double Face Starter	31 ¹ / ₄ "	19 ¹ / ₂ "	96"	8 ¹ / ₂ "	12	14			\$ 5,025	
DW-9620-A-30-WH	Double Face Adder	30 ¹ / ₄ "	19 ¹ / ₂ "	96"	8 ¹ / ₂ "	12	14			\$ 4,481	
DW-9624-S-30-WH	Double Face Starter	31 ¹ / ₄ "	23 ¹ / ₂ "	96"	10 ¹ / ₂ "	12	14			\$ 5,094	
DW-9624-A-30-WH	Double Face Adder	30 ¹ / ₄ "	23 ¹ / ₂ "	96"	10 ¹ / ₂ "	12	14			\$ 4,556	
DW-9628-S-30-WH	Double Face Starter	31 ¹ / ₄ "	28 ¹ / ₂ "	96"	13 ¹ / ₂ "	12	14			\$ 5,831	
DW-9628-A-30-WH	Double Face Adder	30 ¹ / ₄ "	28 ¹ / ₂ "	96"	13 ¹ / ₂ "	12	14			\$ 5,100	
DW-9620-S-36-WH	Double Face Starter	37 ¹ / ₄ "	19 ¹ / ₂ "	96"	8 ¹ / ₂ "	12	14	276 Lbs.	13 Cu Ft	\$ 4,800	
DW-9620-A-36-WH	Double Face Adder	36 ¹ / ₄ "	19 ¹ / ₂ "	96"	8 ¹ / ₂ "	12	14	220 Lbs.	12 Cu Ft	\$ 4,256	
DW-9624-S-36-WH	Double Face Starter	37 ¹ / ₄ "	23 ¹ / ₂ "	96"	10 ¹ / ₂ "	12	14	315 Lbs.	15 Cu Ft	\$ 4,875	
DW-9624-A-36-WH	Double Face Adder	36 ¹ / ₄ "	23 ¹ / ₂ "	96"	10 ¹ / ₂ "	12	14	247 Lbs.	13 Cu Ft	\$ 4,338	
DW-9628-S-36-WH	Double Face Starter	37 ¹ / ₄ "	28 ¹ / ₂ "	96"	13 ¹ / ₂ "	12	14	353 Lbs.	17 Cu Ft	\$ 5,613	
DW-9628-A-36-WH	Double Face Adder	36 ¹ / ₄ "	28 ¹ / ₂ "	96"	13 ¹ / ₂ "	12	14	275 Lbs.	15 Cu Ft	\$ 4,881	



Model Shown
DW-9624-S-36-WH



Model Shown
DW-9624-A-36-WH

SHELVING

MODEL NUMBER	PRODUCT	WIDTH	DEPTH	HEIGHT	SHELF DEPTH	# OF SHELVES	# OF OPENINGS	WEIGHT	VOLUME	LIST PRICE	DESCRIPTION
DW-9610-S-24-SG	Single Face Starter	25 ¹ / ₄ "	10 ¹ / ₈ "	96"	8 ¹ / ₂ "	6	7			\$ 2,856	End, Mid, Top and Base Panels to be constructed from 1" thick 11-ply solid core, veneered 2 sides. Vertical, top and bottom edges banded with ¹ / ₄ " external hardwood edging, edges to be eased. Front Edge: ³ / ₄ " thick x 2 ¹ / ₂ " high fascia - tongue and grooved to top.
DW-9610-A-24-SG	Single Face Adder	24 ¹ / ₄ "	10 ¹ / ₈ "	96"	8 ¹ / ₂ "	6	7			\$ 2,569	
DW-9612-S-24-SG	Single Face Starter	25 ¹ / ₄ "	12 ¹ / ₈ "	96"	10 ¹ / ₂ "	6	7			\$ 2,925	
DW-9612-A-24-SG	Single Face Adder	24 ¹ / ₄ "	12 ¹ / ₈ "	96"	10 ¹ / ₂ "	6	7			\$ 2,619	
DW-9614-S-24-SG	Single Face Starter	25 ¹ / ₄ "	14 ⁵ / ₈ "	96"	13 ¹ / ₂ "	6	7			\$ 3,163	
DW-9614-A-24-SG	Single Face Adder	24 ¹ / ₄ "	14 ⁵ / ₈ "	96"	13 ¹ / ₂ "	6	7			\$ 2,819	
DW-9610-S-30-SG	Single Face Starter	31 ¹ / ₄ "	10 ¹ / ₈ "	96"	8 ¹ / ₂ "	6	7			\$ 2,856	
DW-9610-A-30-SG	Single Face Adder	30 ¹ / ₄ "	10 ¹ / ₈ "	96"	8 ¹ / ₂ "	6	7			\$ 2,569	
DW-9612-S-30-SG	Single Face Starter	31 ¹ / ₄ "	12 ¹ / ₈ "	96"	10 ¹ / ₂ "	6	7			\$ 2,925	
DW-9612-A-30-SG	Single Face Adder	30 ¹ / ₄ "	12 ¹ / ₈ "	96"	10 ¹ / ₂ "	6	7			\$ 2,619	
DW-9614-S-30-SG	Single Face Starter	31 ¹ / ₄ "	14 ⁵ / ₈ "	96"	13 ¹ / ₂ "	6	7			\$ 3,163	
DW-9614-A-30-SG	Single Face Adder	30 ¹ / ₄ "	14 ⁵ / ₈ "	96"	13 ¹ / ₂ "	6	7			\$ 2,819	
DW-9610-S-36-SG	Single Face Starter	37 ¹ / ₄ "	10 ¹ / ₈ "	96"	8 ¹ / ₂ "	6	7	156 Lbs.	9 Cu Ft	\$ 2,719	
DW-9610-A-36-SG	Single Face Adder	36 ¹ / ₄ "	10 ¹ / ₈ "	96"	8 ¹ / ₂ "	6	7	128 Lbs.	8 Cu Ft	\$ 2,431	
DW-9612-S-36-SG	Single Face Starter	37 ¹ / ₄ "	12 ¹ / ₈ "	96"	10 ¹ / ₂ "	6	7	177 Lbs.	10 Cu Ft	\$ 2,781	
DW-9612-A-36-SG	Single Face Adder	36 ¹ / ₄ "	12 ¹ / ₈ "	96"	10 ¹ / ₂ "	6	7	145 Lbs.	9 Cu Ft	\$ 2,481	
DW-9614-S-36-SG	Single Face Starter	37 ¹ / ₄ "	14 ⁵ / ₈ "	96"	13 ¹ / ₂ "	6	7	213 Lbs.	12 Cu Ft	\$ 3,025	
DW-9614-A-36-SG	Single Face Adder	36 ¹ / ₄ "	14 ⁵ / ₈ "	96"	13 ¹ / ₂ "	6	7	175 Lbs.	11 Cu Ft	\$ 2,675	



Model Shown
DW-9612-S-36-SG



Model Shown
DW-9612-A-36-SG

SHELVING

MODEL NUMBER	PRODUCT	WIDTH	DEPTH	HEIGHT	SHELF DEPTH	# OF SHELVES	# OF OPENINGS	WEIGHT	VOLUME	LIST PRICE	DESCRIPTION
DW-9620-S-24-SG	Double Face Starter	25 1/4"	19 1/2"	96"	8 1/2"	12	14			\$ 5,738	End, Mid, Top and Base Panels to be constructed from 1" thick 11-ply solid core, veneered 2 sides. Vertical, top and bottom edges banded with 1/4" external hardwood edging, edges to be eased. Front Edge: 3/4" thick x 2 1/2" high fascia - tongue and grooved to top.
DW-9620-A-24-SG	Double Face Adder	24 1/4"	19 1/2"	96"	8 1/2"	12	14			\$ 5,225	
DW-9624-S-24-SG	Double Face Starter	25 1/4"	23 1/2"	96"	10 1/2"	12	14			\$ 5,825	
DW-9624-A-24-SG	Double Face Adder	24 1/4"	23 1/2"	96"	10 1/2"	12	14			\$ 5,300	
DW-9628-S-24-SG	Double Face Starter	25 1/4"	28 1/2"	96"	13 1/2"	12	14			\$ 6,513	
DW-9628-A-24-SG	Double Face Adder	24 1/4"	28 1/2"	96"	13 1/2"	12	14			\$ 5,819	
DW-9620-S-30-SG	Double Face Starter	31 1/4"	19 1/2"	96"	8 1/2"	12	14			\$ 5,738	
DW-9620-A-30-SG	Double Face Adder	30 1/4"	19 1/2"	96"	8 1/2"	12	14			\$ 5,225	
DW-9624-S-30-SG	Double Face Starter	31 1/4"	23 1/2"	96"	10 1/2"	12	14			\$ 5,825	
DW-9624-A-30-SG	Double Face Adder	30 1/4"	23 1/2"	96"	10 1/2"	12	14			\$ 5,300	
DW-9628-S-30-SG	Double Face Starter	31 1/4"	28 1/2"	96"	13 1/2"	12	14			\$ 6,513	
DW-9628-A-30-SG	Double Face Adder	30 1/4"	28 1/2"	96"	13 1/2"	12	14			\$ 5,819	
DW-9620-S-36-SG	Double Face Starter	37 1/4"	19 1/2"	96"	8 1/2"	12	14	276 Lbs.	13 Cu Ft	\$ 5,531	
DW-9620-A-36-SG	Double Face Adder	36 1/4"	19 1/2"	96"	8 1/2"	12	14	220 Lbs.	12 Cu Ft	\$ 5,013	
DW-9624-S-36-SG	Double Face Starter	37 1/4"	23 1/2"	96"	10 1/2"	12	14	315 Lbs.	15 Cu Ft	\$ 5,600	
DW-9624-A-36-SG	Double Face Adder	36 1/4"	23 1/2"	96"	10 1/2"	12	14	247 Lbs.	13 Cu Ft	\$ 5,088	
DW-9628-S-36-SG	Double Face Starter	37 1/4"	28 1/2"	96"	13 1/2"	12	14	353 Lbs.	17 Cu Ft	\$ 6,300	
DW-9628-A-36-SG	Double Face Adder	36 1/4"	28 1/2"	96"	13 1/2"	12	14	275 Lbs.	15 Cu Ft	\$ 5,606	



Model Shown
DW-9624-S-36-SG



Model Shown
DW-9624-A-36-SG

MODEL NUMBER	PRODUCT	WIDTH	DEPTH	HEIGHT	SHELF DEPTH	# OF SHELVES	# OF OPENINGS	WEIGHT	VOLUME	LIST PRICE	DESCRIPTION
DW-9610-S-24-SG-G	Single Face Starter	25 ¹ / ₄ "	10 ¹ / ₈ "	96"	8 ¹ / ₂ "	6	7			\$ 3,044	End, Mid, Top and Base Panels to be constructed from 1" thick 11-ply solid core, veneered 2 sides. Vertical, top and bottom edges banded with ¹ / ₄ " external hardwood edging, edges to be eased. Front Edge: ³ / ₄ " thick x 2 ¹ / ₂ " high fascia - tongue and grooved to top.
DW-9610-A-24-SG-G	Single Face Adder	24 ¹ / ₄ "	10 ¹ / ₈ "	96"	8 ¹ / ₂ "	6	7			\$ 2,756	
DW-9612-S-24-SG-G	Single Face Starter	25 ¹ / ₄ "	12 ¹ / ₈ "	96"	10 ¹ / ₂ "	6	7			\$ 3,150	
DW-9612-A-24-SG-G	Single Face Adder	24 ¹ / ₄ "	12 ¹ / ₈ "	96"	10 ¹ / ₂ "	6	7			\$ 2,844	
DW-9614-S-24-SG-G	Single Face Starter	25 ¹ / ₄ "	14 ⁵ / ₈ "	96"	13 ¹ / ₂ "	6	7			\$ 3,500	
DW-9614-A-24-SG-G	Single Face Adder	24 ¹ / ₄ "	14 ⁵ / ₈ "	96"	13 ¹ / ₂ "	6	7			\$ 3,156	
DW-9610-S-30-SG-G	Single Face Starter	31 ¹ / ₄ "	10 ¹ / ₈ "	96"	8 ¹ / ₂ "	6	7			\$ 3,044	
DW-9610-A-30-SG-G	Single Face Adder	30 ¹ / ₄ "	10 ¹ / ₈ "	96"	8 ¹ / ₂ "	6	7			\$ 2,756	
DW-9612-S-30-SG-G	Single Face Starter	31 ¹ / ₄ "	12 ¹ / ₈ "	96"	10 ¹ / ₂ "	6	7			\$ 3,150	
DW-9612-A-30-SG-G	Single Face Adder	30 ¹ / ₄ "	12 ¹ / ₈ "	96"	10 ¹ / ₂ "	6	7			\$ 2,844	
DW-9614-S-30-SG-G	Single Face Starter	31 ¹ / ₄ "	14 ⁵ / ₈ "	96"	13 ¹ / ₂ "	6	7			\$ 3,500	
DW-9614-A-30-SG-G	Single Face Adder	30 ¹ / ₄ "	14 ⁵ / ₈ "	96"	13 ¹ / ₂ "	6	7			\$ 3,156	
DW-9610-S-36-SG-G	Single Face Starter	37 ¹ / ₄ "	10 ¹ / ₈ "	96"	8 ¹ / ₂ "	6	7	156 Lbs.	9 Cu Ft	\$ 2,906	
DW-9610-A-36-SG-G	Single Face Adder	36 ¹ / ₄ "	10 ¹ / ₈ "	96"	8 ¹ / ₂ "	6	7	128 Lbs.	8 Cu Ft	\$ 2,619	
DW-9612-S-36-SG-G	Single Face Starter	37 ¹ / ₄ "	12 ¹ / ₈ "	96"	10 ¹ / ₂ "	6	7	177 Lbs.	10 Cu Ft	\$ 3,006	
DW-9612-A-36-SG-G	Single Face Adder	36 ¹ / ₄ "	12 ¹ / ₈ "	96"	10 ¹ / ₂ "	6	7	145 Lbs.	9 Cu Ft	\$ 2,706	
DW-9614-S-36-SG-G	Single Face Starter	37 ¹ / ₄ "	14 ⁵ / ₈ "	96"	13 ¹ / ₂ "	6	7	213 Lbs.	12 Cu Ft	\$ 3,363	
DW-9614-A-36-SG-G	Single Face Adder	36 ¹ / ₄ "	14 ⁵ / ₈ "	96"	13 ¹ / ₂ "	6	7	175 Lbs.	11 Cu Ft	\$ 3,013	



Model Shown
DW-9612-S-36-SG-G



Model Shown
DW-9612-A-36-SG-G

MODEL NUMBER	PRODUCT	WIDTH	DEPTH	HEIGHT	SHELF DEPTH	# OF SHELVES	# OF OPENINGS	WEIGHT	VOLUME	LIST PRICE	DESCRIPTION
--------------	---------	-------	-------	--------	-------------	--------------	---------------	--------	--------	------------	-------------







Model Shown
DW-9624-S-36-SG-G







Model Shown
DW-9624-A-36-SG-G





DW-9620-S-24-SG-G	Double Face Starter	25 1/4"	19 1/2"	96"	8 1/2"	12	14			\$ 6,331	End, Mid, Top and Base Panels to be constructed from 1" thick 11-ply solid core, veneered 2 sides. Vertical, top and bottom edges banded with 1/4" external hardwood edging, edges to be eased. Front Edge: 3/4" thick x 2 1/2" high fascia - tongue and grooved to top.
DW-9620-A-24-SG-G	Double Face Adder	24 1/4"	19 1/2"	96"	8 1/2"	12	14			\$ 5,800	
DW-9624-S-24-SG-G	Double Face Starter	25 1/4"	23 1/2"	96"	10 1/2"	12	14			\$ 6,600	
DW-9624-A-24-SG-G	Double Face Adder	24 1/4"	23 1/2"	96"	10 1/2"	12	14			\$ 6,069	
DW-9628-S-24-SG-G	Double Face Starter	25 1/4"	28 1/2"	96"	13 1/2"	12	14			\$ 7,431	
DW-9628-A-24-SG-G	Double Face Adder	24 1/4"	28 1/2"	96"	13 1/2"	12	14			\$ 6,706	
DW-9620-S-30-SG-G	Double Face Starter	31 1/4"	19 1/2"	96"	8 1/2"	12	14			\$ 6,331	
DW-9620-A-30-SG-G	Double Face Adder	30 1/4"	19 1/2"	96"	8 1/2"	12	14			\$ 5,800	
DW-9624-S-30-SG-G	Double Face Starter	31 1/4"	23 1/2"	96"	10 1/2"	12	14			\$ 6,600	
DW-9624-A-30-SG-G	Double Face Adder	30 1/4"	23 1/2"	96"	10 1/2"	12	14			\$ 6,069	
DW-9628-S-30-SG-G	Double Face Starter	31 1/4"	28 1/2"	96"	13 1/2"	12	14			\$ 7,431	
DW-9628-A-30-SG-G	Double Face Adder	30 1/4"	28 1/2"	96"	13 1/2"	12	14			\$ 6,706	
DW-9620-S-36-SG-G	Double Face Starter	37 1/4"	19 1/2"	96"	8 1/2"	12	14	276 Lbs.	13 Cu Ft	\$ 6,031	
DW-9620-A-36-SG-G	Double Face Adder	36 1/4"	19 1/2"	96"	8 1/2"	12	14	220 Lbs.	12 Cu Ft	\$ 5,525	
DW-9624-S-36-SG-G	Double Face Starter	37 1/4"	23 1/2"	96"	10 1/2"	12	14	315 Lbs.	15 Cu Ft	\$ 6,288	
DW-9624-A-36-SG-G	Double Face Adder	36 1/4"	23 1/2"	96"	10 1/2"	12	14	247 Lbs.	13 Cu Ft	\$ 5,663	
DW-9628-S-36-SG-G	Double Face Starter	37 1/4"	28 1/2"	96"	13 1/2"	12	14	353 Lbs.	17 Cu Ft	\$ 7,075	
DW-9628-A-36-SG-G	Double Face Adder	36 1/4"	28 1/2"	96"	13 1/2"	12	14	275 Lbs.	15 Cu Ft	\$ 6,388	



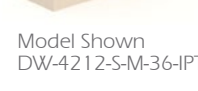

SHELVING

MODEL NUMBER	PRODUCT	WIDTH	DEPTH	HEIGHT	SHELF DEPTH	# OF SHELVES	# OF OPENINGS	WEIGHT	VOLUME	LIST PRICE	DESCRIPTION
 Model Shown DW-3612-S-M-36	DW-3612-S-M-24	25 1/4"	12 1/8"	36"		1	2			\$ 1,475	End, Mid, Top and Base Panels to be constructed from 1" thick 11-ply solid core, veneered 2 sides. Vertical, top and bottom edges banded with 1/4" external hardwood edging, edges to be eased. Front Edge: 3/4" thick x 2 1/2" high fascia - tongue and grooved to top.
	DW-3612-A-M-24	24 1/4"	12 1/8"	36"		1	2			\$ 1,156	
	DW-3612-S-M-30	31 1/4"	12 1/8"	36"		1	2			\$ 1,475	
	DW-3612-A-M-30	30 1/4"	12 1/8"	36"		1	2			\$ 1,156	
	DW-3612-S-M-36	37 1/4"	12 1/8"	36"		1	2	80.5 Lbs.	6 Cu Ft	\$ 1,325	
	DW-3612-A-M-36	36 1/4"	12 1/8"	36"		1	2	77.1 Lbs.	6 Cu Ft	\$ 1,013	
 Model Shown DW-4212-S-M-36	DW-4212-S-M-24	25 1/4"	12 1/8"	42"		2	3			\$ 1,738	
	DW-4212-A-M-24	24 1/4"	12 1/8"	42"		2	3			\$ 1,419	
	DW-4212-S-M-30	31 1/4"	12 1/8"	42"		2	3			\$ 1,738	
	DW-4212-A-M-30	30 1/4"	12 1/8"	42"		2	3			\$ 1,419	
	DW-4212-S-M-36	37 1/4"	12 1/8"	42"		2	3	82.5 Lbs.	7 Cu Ft	\$ 1,588	
	DW-4212-A-M-36	36 1/4"	12 1/8"	42"		2	3	80 Lbs.	7 Cu Ft	\$ 1,275	
 Model Shown DW-4812-S-M-36	DW-4812-S-M-24	25 1/4"	12 1/8"	48"		2	3			\$ 1,738	
	DW-4812-A-M-24	24 1/4"	12 1/8"	48"		2	3			\$ 1,419	
	DW-4812-S-M-30	31 1/4"	12 1/8"	48"		2	3			\$ 1,738	
	DW-4812-A-M-30	30 1/4"	12 1/8"	48"		2	3			\$ 1,419	
	DW-4812-S-M-36	37 1/4"	12 1/8"	48"		2	3	128 Lbs.	7 Cu Ft	\$ 1,588	
	DW-4812-A-M-36	36 1/4"	12 1/8"	48"		2	3	116 Lbs.	7 Cu Ft	\$ 1,275	
 Model Shown DW-6012-S-M-36	DW-6012-S-M-24	25 1/4"	12 1/8"	60"		3	4			\$ 1,994	
	DW-6012-A-M-24	24 1/4"	12 1/8"	60"		3	4			\$ 1,681	
	DW-6012-S-M-30	31 1/4"	12 1/8"	60"		3	4			\$ 1,994	
	DW-6012-A-M-30	30 1/4"	12 1/8"	60"		3	4			\$ 1,681	
	DW-6012-S-M-36	37 1/4"	12 1/8"	60"		3	4	176 Lbs.	10 Cu Ft	\$ 1,844	
	DW-6012-A-M-36	36 1/4"	12 1/8"	60"		3	4	155 Lbs.	9 Cu Ft	\$ 1,531	
 Model Shown DW-7212-S-M-36	DW-7212-S-M-24	25 1/4"	12 1/8"	72"		4	5			\$ 2,263	
	DW-7212-A-M-24	24 1/4"	12 1/8"	72"		4	5			\$ 1,944	
	DW-7212-S-M-30	31 1/4"	12 1/8"	72"		4	5			\$ 2,263	
	DW-7212-A-M-30	30 1/4"	12 1/8"	72"		4	5			\$ 1,944	
	DW-7212-S-M-36	37 1/4"	12 1/8"	72"		4	5	206 Lbs.	11 Cu Ft	\$ 2,119	
	DW-7212-A-M-36	36 1/4"	12 1/8"	72"		4	5	184 Lbs.	10 Cu Ft	\$ 1,800	



SHELVING

	MODEL NUMBER	PRODUCT	WIDTH	DEPTH	HEIGHT	SHELF DEPTH	# OF SHELVES	# OF OPENINGS	WEIGHT	VOLUME	LIST PRICE	DESCRIPTION
 Model Shown DW-3624-S-M-36	DW-3624-S-M-24	Double Face Starter	25 1/4"	23 1/2"	36"		2	4			\$ 2,644	End, Mid, Top and Base Panels to be constructed from 1" thick 11-ply solid core, veneered 2 sides. Vertical, top and bottom edges banded with 1/4" external hardwood edging, edges to be eased. Front Edge: 3/4" thick x 2 1/2" high fascia - tongue and grooved to top.
	DW-3624-A-M-24	Double Face Adder	24 1/4"	23 1/2"	36"		2	4			\$ 2,106	
	DW-3624-S-M-30	Double Face Starter	31 1/4"	23 1/2"	36"		2	4			\$ 2,644	
	DW-3624-A-M-30	Double Face Adder	30 1/4"	23 1/2"	36"		2	4			\$ 2,106	
	DW-3624-S-M-36	Double Face Starter	37 1/4"	23 1/2"	36"		2	4	170 Lbs.	12 Cu Ft	\$ 2,419	
	DW-3624-A-M-36	Double Face Adder	36 1/4"	23 1/2"	36"		2	4	148 Lbs.	11 Cu Ft	\$ 1,881	
 Model Shown DW-4224-S-M-36	DW-4224-S-M-24	Double Face Starter	25 1/4"	23 1/2"	42"		4	6			\$ 3,175	
	DW-4224-A-M-24	Double Face Adder	24 1/4"	23 1/2"	42"		4	6			\$ 2,631	
	DW-4224-S-M-30	Double Face Starter	31 1/4"	23 1/2"	42"		4	6			\$ 3,175	
	DW-4224-A-M-30	Double Face Adder	30 1/4"	23 1/2"	42"		4	6			\$ 2,631	
	DW-4224-S-M-36	Double Face Starter	37 1/4"	23 1/2"	42"		4	6	180 Lbs.	13 Cu Ft	\$ 2,950	
	DW-4224-A-M-36	Double Face Adder	36 1/4"	23 1/2"	42"		4	6	158 Lbs.	12 Cu Ft	\$ 2,413	
 Model Shown DW-4824-S-M-36	DW-4824-S-M-24	Double Face Starter	25 1/4"	23 1/2"	48"		4	6			\$ 3,175	
	DW-4824-A-M-24	Double Face Adder	24 1/4"	23 1/2"	48"		4	6			\$ 2,631	
	DW-4824-S-M-30	Double Face Starter	31 1/4"	23 1/2"	48"		4	6			\$ 3,175	
	DW-4824-A-M-30	Double Face Adder	30 1/4"	23 1/2"	48"		4	6			\$ 2,631	
	DW-4824-S-M-36	Double Face Starter	37 1/4"	23 1/2"	48"		4	6	245 Lbs.	14 Cu Ft	\$ 2,950	
	DW-4824-A-M-36	Double Face Adder	36 1/4"	23 1/2"	48"		4	6	216 Lbs.	13 Cu Ft	\$ 2,413	
 Model Shown DW-6024-S-M-36	DW-6024-S-M-24	Double Face Starter	25 1/4"	23 1/2"	60"		6	8			\$ 3,669	
	DW-6024-A-M-24	Double Face Adder	24 1/4"	23 1/2"	60"		6	8			\$ 3,131	
	DW-6024-S-M-30	Double Face Starter	31 1/4"	23 1/2"	60"		6	8			\$ 3,669	
	DW-6024-A-M-30	Double Face Adder	30 1/4"	23 1/2"	60"		6	8			\$ 3,131	
	DW-6024-S-M-36	Double Face Starter	37 1/4"	23 1/2"	60"		6	8	320 Lbs.	16 Cu Ft	\$ 3,450	
	DW-6024-A-M-36	Double Face Adder	36 1/4"	23 1/2"	60"		6	8	284 Lbs.	15 Cu Ft	\$ 2,906	
 Model Shown DW-7224-S-M-36	DW-7224-S-M-24	Double Face Starter	25 1/4"	23 1/2"	72"		8	10			\$ 4,194	
	DW-7224-A-M-24	Double Face Adder	24 1/4"	23 1/2"	72"		8	10			\$ 3,650	
	DW-7224-S-M-30	Double Face Starter	31 1/4"	23 1/2"	72"		8	10			\$ 4,194	
	DW-7224-A-M-30	Double Face Adder	30 1/4"	23 1/2"	72"		8	10			\$ 3,650	
	DW-7224-S-M-36	Double Face Starter	37 1/4"	23 1/2"	72"		8	10	378 Lbs.	18 Cu Ft	\$ 3,969	
	DW-7224-A-M-36	Double Face Adder	36 1/4"	23 1/2"	72"		8	10	336 Lbs.	17 Cu Ft	\$ 3,425	





MODEL NUMBER	PRODUCT	WIDTH	DEPTH	HEIGHT	SHELF DEPTH	# OF SHELVES	# OF OPENINGS	WEIGHT	VOLUME	LIST PRICE	DESCRIPTION
 Model Shown DW-3612-S-M-36-IPT	DW-3612-S-M-24-IPT	Single Face Starter	25 1/4"	12 1/8"	36"	1	2			\$ 1,550	End, Mid, Top and Base Panels to be constructed from 1" thick 11-ply solid core, veneered 2 sides. Vertical, top and bottom edges banded with 1/4" external hardwood edging, edges to be eased. Front Edge: 3/4" thick x 2 1/2" high fascia - tongue and grooved to top.
	DW-3612-A-M-24-IPT	Single Face Adder	24 1/4"	12 1/8"	36"	1	2			\$ 1,231	
	DW-3612-S-M-30-IPT	Single Face Starter	31 1/4"	12 1/8"	36"	1	2			\$ 1,550	
	DW-3612-A-M-30-IPT	Single Face Adder	30 1/4"	12 1/8"	36"	1	2			\$ 1,231	
	DW-3612-S-M-36-IPT	Single Face Starter	37 1/4"	12 1/8"	36"	1	2	80.5 Lbs.	6 Cu Ft	\$ 1,400	
	DW-3612-A-M-36-IPT	Single Face Adder	36 1/4"	12 1/8"	36"	1	2	77.1 Lbs.	6 Cu Ft	\$ 1,081	
 Model Shown DW-4212-S-M-36-IPT	DW-4212-S-M-24-IPT	Single Face Starter	25 1/4"	12 1/8"	42"	2	3			\$ 1,813	
	DW-4212-A-M-24-IPT	Single Face Adder	24 1/4"	12 1/8"	42"	2	3			\$ 1,494	
	DW-4212-S-M-30-IPT	Single Face Starter	31 1/4"	12 1/8"	42"	2	3			\$ 1,813	
	DW-4212-A-M-30-IPT	Single Face Adder	30 1/4"	12 1/8"	42"	2	3			\$ 1,494	
	DW-4212-S-M-36-IPT	Single Face Starter	37 1/4"	12 1/8"	42"	2	3	82.5 Lbs.	7 Cu Ft	\$ 1,663	
	DW-4212-A-M-36-IPT	Single Face Adder	36 1/4"	12 1/8"	42"	2	3	80 Lbs.	7 Cu Ft	\$ 1,350	
 Model Shown DW-4812-S-M-36-IPT	DW-4812-S-M-24-IPT	Single Face Starter	25 1/4"	12 1/8"	48"	2	3			\$ 1,813	
	DW-4812-A-M-24-IPT	Single Face Adder	24 1/4"	12 1/8"	48"	2	3			\$ 1,494	
	DW-4812-S-M-30-IPT	Single Face Starter	31 1/4"	12 1/8"	48"	2	3			\$ 1,813	
	DW-4812-A-M-30-IPT	Single Face Adder	30 1/4"	12 1/8"	48"	2	3			\$ 1,494	
	DW-4812-S-M-36-IPT	Single Face Starter	37 1/4"	12 1/8"	48"	2	3	128 Lbs.	7 Cu Ft	\$ 1,663	
	DW-4812-A-M-36-IPT	Single Face Adder	36 1/4"	12 1/8"	48"	2	3	116 Lbs.	7 Cu Ft	\$ 1,350	
 Model Shown DW-6012-S-M-36-IPT	DW-6012-S-M-24-IPT	Single Face Starter	25 1/4"	12 1/8"	60"	3	4			\$ 2,069	
	DW-6012-A-M-24-IPT	Single Face Adder	24 1/4"	12 1/8"	60"	3	4			\$ 1,756	
	DW-6012-S-M-30-IPT	Single Face Starter	31 1/4"	12 1/8"	60"	3	4			\$ 2,069	
	DW-6012-A-M-30-IPT	Single Face Adder	30 1/4"	12 1/8"	60"	3	4			\$ 1,756	
	DW-6012-S-M-36-IPT	Single Face Starter	37 1/4"	12 1/8"	60"	3	4	176 Lbs.	10 Cu Ft	\$ 1,919	
	DW-6012-A-M-36-IPT	Single Face Adder	36 1/4"	12 1/8"	60"	3	4	155 Lbs.	9 Cu Ft	\$ 1,606	

	MODEL NUMBER	PRODUCT	WIDTH	DEPTH	HEIGHT	SHELF DEPTH	# OF SHELVES	# OF OPENINGS	WEIGHT	VOLUME	LIST PRICE	DESCRIPTION
 <p>Model Shown DW-3612-S-M-36-IPT</p>	DW-3624-S-M-24-IPT	Double Face Starter	25 1/4"	23 1/2"	36"		2	4			\$ 2,794	End, Mid, Top and Base Panels to be constructed from 1" thick 11-ply solid core, veneered 2 sides. Vertical, top and bottom edges banded with 1/4" external hardwood edging, edges to be eased. Front Edge: 3/4" thick x 2 1/2" high fascia - tongue and grooved to top.
	DW-3624-A-M-24-IPT	Double Face Adder	24 1/4"	23 1/2"	36"		2	4			\$ 2,256	
	DW-3624-S-M-30-IPT	Double Face Starter	31 1/4"	23 1/2"	36"		2	4			\$ 2,794	
	DW-3624-A-M-30-IPT	Double Face Adder	30 1/4"	23 1/2"	36"		2	4			\$ 2,256	
	DW-3624-S-M-36-IPT	Double Face Starter	37 1/4"	23 1/2"	36"		2	4	170 Lbs.	12 Cu Ft	\$ 2,569	
	DW-3624-A-M-36-IPT	Double Face Adder	36 1/4"	23 1/2"	36"		2	4	148 Lbs.	11 Cu Ft	\$ 2,031	
 <p>Model Shown DW-4212-S-M-36-IPT</p>	DW-4224-S-M-24-IPT	Double Face Starter	25 1/4"	23 1/2"	42"		4	6			\$ 3,325	
	DW-4224-A-M-24-IPT	Double Face Adder	24 1/4"	23 1/2"	42"		4	6			\$ 2,781	
	DW-4224-S-M-30-IPT	Double Face Starter	31 1/4"	23 1/2"	42"		4	6			\$ 3,325	
	DW-4224-A-M-30-IPT	Double Face Adder	30 1/4"	23 1/2"	42"		4	6			\$ 2,781	
	DW-4224-S-M-36-IPT	Double Face Starter	37 1/4"	23 1/2"	42"		4	6	180 Lbs.	13 Cu Ft	\$ 3,313	
	DW-4224-A-M-36-IPT	Double Face Adder	36 1/4"	23 1/2"	42"		4	6	158 Lbs.	12 Cu Ft	\$ 2,556	
 <p>Model Shown DW-4812-S-M-36-IPT</p>	DW-4824-S-M-24-IPT	Double Face Starter	25 1/4"	23 1/2"	48"		4	6			\$ 3,488	
	DW-4824-A-M-24-IPT	Double Face Adder	24 1/4"	23 1/2"	48"		4	6			\$ 2,919	
	DW-4824-S-M-30-IPT	Double Face Starter	31 1/4"	23 1/2"	48"		4	6			\$ 3,488	
	DW-4824-A-M-30-IPT	Double Face Adder	30 1/4"	23 1/2"	48"		4	6			\$ 2,919	
	DW-4824-S-M-36-IPT	Double Face Starter	37 1/4"	23 1/2"	48"		4	6	245 Lbs.	14 Cu Ft	\$ 3,256	
	DW-4824-A-M-36-IPT	Double Face Adder	36 1/4"	23 1/2"	48"		4	6	216 Lbs.	13 Cu Ft	\$ 2,688	
 <p>Model Shown DW-6012-S-M-36-IPT</p>	DW-6024-S-M-24-IPT	Double Face Starter	25 1/4"	23 1/2"	60"		6	8			\$ 3,819	
	DW-6024-A-M-24-IPT	Double Face Adder	24 1/4"	23 1/2"	60"		6	8			\$ 3,281	
	DW-6024-S-M-30-IPT	Double Face Starter	31 1/4"	23 1/2"	60"		6	8			\$ 3,819	
	DW-6024-A-M-30-IPT	Double Face Adder	30 1/4"	23 1/2"	60"		6	8			\$ 3,281	
	DW-6024-S-M-36-IPT	Double Face Starter	37 1/4"	23 1/2"	60"		6	8	320 Lbs.	16 Cu Ft	\$ 3,600	
	DW-6024-A-M-36-IPT	Double Face Adder	36 1/4"	23 1/2"	60"		6	8	284 Lbs.	15 Cu Ft	\$ 3,056	

SHELVING

MODEL NUMBER	PRODUCT	WIDTH	DEPTH	HEIGHT	SHELF DEPTH	# OF SHELVES	# OF OPENINGS	WEIGHT	VOLUME	LIST PRICE	DESCRIPTION
	DW-3612-S-P-24	Single Face Starter	25 1/4"	12 1/8"	36"	1	2			\$ 1,294	End, Mid, Top and Base Panels to be constructed from 1" thick 11-ply solid core, veneered 2 sides. Vertical, top and bottom edges banded with 1/4" external hardwood edging, edges to be eased. Front Edge: 3/4" thick x 2 1/2" high fascia - tongue and grooved to top.
	DW-3612-A-P-24	Single Face Adder	24 1/4"	12 1/8"	36"	1	2			\$ 963	
	DW-3612-S-P-30	Single Face Starter	31 1/4"	12 1/8"	36"	1	2			\$ 1,294	
	DW-3612-A-P-30	Single Face Adder	30 1/4"	12 1/8"	36"	1	2			\$ 963	
	DW-3612-S-P-36	Single Face Starter	37 1/4"	12 1/8"	36"	1	2	52.9 Lbs.	5 Cu Ft	\$ 1,169	
	DW-3612-A-P-36	Single Face Adder	36 1/4"	12 1/8"	36"	1	2	49.5 Lbs.	5 Cu Ft	\$ 838	
	DW-4212-S-P-24	Single Face Starter	25 1/4"	12 1/8"	42"	2	3			\$ 1,375	
	DW-4212-A-P-24	Single Face Adder	24 1/4"	12 1/8"	42"	2	3			\$ 1,025	
	DW-4212-S-P-30	Single Face Starter	31 1/4"	12 1/8"	42"	2	3			\$ 1,375	
	DW-4212-A-P-30	Single Face Adder	30 1/4"	12 1/8"	42"	2	3			\$ 1,025	
	DW-4212-S-P-36	Single Face Starter	37 1/4"	12 1/8"	42"	2	3	58 Lbs.	6 Cu Ft	\$ 1,244	
	DW-4212-A-P-36	Single Face Adder	36 1/4"	12 1/8"	42"	2	3	56 Lbs.	6 Cu Ft	\$ 894	
	DW-4812-S-P-24	Single Face Starter	25 1/4"	12 1/8"	48"	2	3			\$ 1,456	
	DW-4812-A-P-24	Single Face Adder	24 1/4"	12 1/8"	48"	2	3			\$ 1,088	
	DW-4812-S-P-30	Single Face Starter	31 1/4"	12 1/8"	48"	2	3			\$ 1,456	
	DW-4812-A-P-30	Single Face Adder	30 1/4"	12 1/8"	48"	2	3			\$ 1,088	
	DW-4812-S-P-36	Single Face Starter	37 1/4"	12 1/8"	48"	2	3	86.3 Lbs.	6 Cu Ft	\$ 1,300	
	DW-4812-A-P-36	Single Face Adder	36 1/4"	12 1/8"	48"	2	3	74.8 Lbs.	6 Cu Ft	\$ 938	

SHELVING

MODEL NUMBER	PRODUCT	WIDTH	DEPTH	HEIGHT	SHELF DEPTH	# OF SHELVES	# OF OPENINGS	WEIGHT	VOLUME	LIST PRICE	DESCRIPTION
	DW-3624-S-P-24	25 1/4"	23 1/2"	36"		2	4			\$ 2,188	End, Mid, Top and Base Panels to be constructed from 1" thick 11-ply solid core, veneered 2 sides. Vertical, top and bottom edges banded with 1/4" external hardwood edging, edges to be eased. Front Edge: 3/4" thick x 2 1/2" high fascia - tongue and grooved to top.
	DW-3624-A-P-24	24 1/4"	23 1/2"	36"		2	4			\$ 1,819	
	DW-3624-S-P-30	31 1/4"	23 1/2"	36"		2	4			\$ 2,188	
	DW-3624-A-P-30	30 1/4"	23 1/2"	36"		2	4			\$ 1,819	
	DW-3624-S-P-36	37 1/4"	23 1/2"	36"		2	4	115 Lbs.	10 Cu Ft	\$ 2,000	
	DW-3624-A-P-36	36 1/4"	23 1/2"	36"		2	4	93.2 Lbs.	9 Cu Ft	\$ 1,631	
											
	DW-4224-S-P-24	25 1/4"	23 1/2"	42"		4	6			\$ 2,331	
	DW-4224-A-P-24	24 1/4"	23 1/2"	42"		4	6			\$ 1,938	
	DW-4224-S-P-30	31 1/4"	23 1/2"	42"		4	6			\$ 2,331	
	DW-4224-A-P-30	30 1/4"	23 1/2"	42"		4	6			\$ 1,938	
	DW-4224-S-P-36	37 1/4"	23 1/2"	42"		4	6	125 Lbs.	11 Cu Ft	\$ 2,125	
	DW-4224-A-P-36	36 1/4"	23 1/2"	42"		4	6	98 Lbs.	10 Cu Ft	\$ 1,738	
	DW-4824-S-P-24	25 1/4"	23 1/2"	48"		4	6			\$ 2,588	
	DW-4824-A-P-24	24 1/4"	23 1/2"	48"		4	6			\$ 2,031	
	DW-4824-S-P-30	31 1/4"	23 1/2"	48"		4	6			\$ 2,588	
	DW-4824-A-P-30	30 1/4"	23 1/2"	48"		4	6			\$ 2,031	
	DW-4824-S-P-36	37 1/4"	23 1/2"	48"		4	6	162 Lbs.	11 Cu Ft	\$ 2,381	
	DW-4824-A-P-36	36 1/4"	23 1/2"	48"		4	6	133 Lbs.	10 Cu Ft	\$ 1,831	

SHELVING

MODEL NUMBER	PRODUCT	WIDTH	DEPTH	HEIGHT	SHELF DEPTH	# OF SHELVES	# OF OPENINGS	WEIGHT	VOLUME	LIST PRICE	DESCRIPTION
--------------	---------	-------	-------	--------	-------------	--------------	---------------	--------	--------	------------	-------------



Model Shown
DW-3612-S-P-36-IPT

DW-3612-S-P-24-IPT	Single Face Starter	25 1/4"	12 1/8"	36"		1	2			\$ 1,369	End, Mid, Top and Base Panels to be constructed from 1" thick 11-ply solid core, veneered 2 sides. Vertical, top and bottom edges banded with 1/4" external hardwood edging, edges to be eased. Front Edge: 3/4" thick x 2 1/2" high fascia - tongue and grooved to top.
DW-3612-A-P-24-IPT	Single Face Adder	24 1/4"	12 1/8"	36"		1	2			\$ 1,038	
DW-3612-S-P-30-IPT	Single Face Starter	31 1/4"	12 1/8"	36"		1	2			\$ 1,369	
DW-3612-A-P-30-IPT	Single Face Adder	30 1/4"	12 1/8"	36"		1	2			\$ 1,038	
DW-3612-S-P-36-IPT	Single Face Starter	37 1/4"	12 1/8"	36"		1	2	52.9 Lbs.	5 Cu Ft	\$ 1,244	
DW-3612-A-P-36-IPT	Single Face Adder	36 1/4"	12 1/8"	36"		1	2	49.5 Lbs.	5 Cu Ft	\$ 913	



Model Shown
DW-3612-A-P-36-IPT

DW-4212-S-P-24-IPT	Single Face Starter	25 1/4"	12 1/8"	42"		2	3			\$ 1,450	
DW-4212-A-P-24-IPT	Single Face Adder	24 1/4"	12 1/8"	42"		2	3			\$ 1,100	
DW-4212-S-P-30-IPT	Single Face Starter	31 1/4"	12 1/8"	42"		2	3			\$ 1,450	
DW-4212-A-P-30-IPT	Single Face Adder	30 1/4"	12 1/8"	42"		2	3			\$ 1,100	
DW-4212-S-P-36-IPT	Single Face Starter	37 1/4"	12 1/8"	42"		2	3	58 Lbs.	6 Cu Ft	\$ 1,319	
DW-4212-A-P-36-IPT	Single Face Adder	36 1/4"	12 1/8"	42"		2	3	56 Lbs.	6 Cu Ft	\$ 969	





Model Shown
DW-4812-S-P-36-IPT

DW-4812-S-P-24-IPT	Single Face Starter	25 1/4"	12 1/8"	48"		2	3			\$ 1,531	
DW-4812-A-P-24-IPT	Single Face Adder	24 1/4"	12 1/8"	48"		2	3			\$ 1,163	
DW-4812-S-P-30-IPT	Single Face Starter	31 1/4"	12 1/8"	48"		2	3			\$ 1,531	
DW-4812-A-P-30-IPT	Single Face Adder	30 1/4"	12 1/8"	48"		2	3			\$ 1,163	
DW-4812-S-P-36-IPT	Single Face Starter	37 1/4"	12 1/8"	48"		2	3	86.3 Lbs.	6 Cu Ft	\$ 1,375	
DW-4812-A-P-36-IPT	Single Face Adder	36 1/4"	12 1/8"	48"		2	3	74.8 Lbs.	6 Cu Ft	\$ 1,013	



Model Shown
DW-4812-A-P-36-IPT

SHELVING

	MODEL NUMBER	PRODUCT	WIDTH	DEPTH	HEIGHT	SHELF DEPTH	# OF SHELVES	# OF OPENINGS	WEIGHT	VOLUME	LIST PRICE	DESCRIPTION
 <p>Model Shown DW-3624-S-P-36-IPT</p>	DW-3624-S-P-24-IPT	Double Face Starter	25 1/4"	23 1/2"	36"		2	4			\$ 2,338	End, Mid, Top and Base Panels to be constructed from 1" thick 11-ply solid core, veneered 2 sides. Vertical, top and bottom edges banded with 1/4" external hardwood edging, edges to be eased. Front Edge: 3/4" thick x 2 1/2" high fascia - tongue and grooved to top.
	DW-3624-A-P-24-IPT	Double Face Adder	24 1/4"	23 1/2"	36"		2	4			\$ 1,969	
	DW-3624-S-P-30-IPT	Double Face Starter	31 1/4"	23 1/2"	36"		2	4			\$ 2,338	
	DW-3624-A-P-30-IPT	Double Face Adder	30 1/4"	23 1/2"	36"		2	4			\$ 1,969	
	DW-3624-S-P-36-IPT	Double Face Starter	37 1/4"	23 1/2"	36"		2	4	115 Lbs.	10 Cu Ft	\$ 2,150	
	DW-3624-A-P-36-IPT	Double Face Adder	36 1/4"	23 1/2"	36"		2	4	93.2 Lbs.	9 Cu Ft	\$ 1,781	
 <p>Model Shown DW-3624-A-P-36-IPT</p>	DW-4224-S-P-24-IPT	Double Face Starter	25 1/4"	23 1/2"	42"		4	6			\$ 2,481	
	DW-4224-A-P-24-IPT	Double Face Adder	24 1/4"	23 1/2"	42"		4	6			\$ 2,088	
	DW-4224-S-P-30-IPT	Double Face Starter	31 1/4"	23 1/2"	42"		4	6			\$ 2,481	
	DW-4224-A-P-30-IPT	Double Face Adder	30 1/4"	23 1/2"	42"		4	6			\$ 2,088	
	DW-4224-S-P-36-IPT	Double Face Starter	37 1/4"	23 1/2"	42"		4	6	125 Lbs.	11 Cu Ft	\$ 2,275	
	DW-4224-A-P-36-IPT	Double Face Adder	36 1/4"	23 1/2"	42"		4	6	98 Lbs.	10 Cu Ft	\$ 1,888	
 <p>Model Shown DW-4824-S-P-36-IPT</p>	DW-4824-S-P-24-IPT	Double Face Starter	25 1/4"	23 1/2"	48"		4	6			\$ 2,738	
	DW-4824-A-P-24-IPT	Double Face Adder	24 1/4"	23 1/2"	48"		4	6			\$ 2,181	
	DW-4824-S-P-30-IPT	Double Face Starter	31 1/4"	23 1/2"	48"		4	6			\$ 2,738	
	DW-4824-A-P-30-IPT	Double Face Adder	30 1/4"	23 1/2"	48"		4	6			\$ 2,181	
	DW-4824-S-P-36-IPT	Double Face Starter	37 1/4"	23 1/2"	48"		4	6	162 Lbs.	11 Cu Ft	\$ 2,531	
	DW-4824-A-P-36-IPT	Double Face Adder	36 1/4"	23 1/2"	48"		4	6	133 Lbs.	10 Cu Ft	\$ 1,981	

MODEL NUMBER	PRODUCT	WIDTH	DEPTH	HEIGHT	SHELF DEPTH	# OF SHELVES	# OF OPENINGS	WEIGHT	VOLUME	LIST PRICE	DESCRIPTION
	A-Frame Shelving, Single Face;										
DW-AF-4818-S-36	Starter	37 ³ / ₈ "	18"	48"	5 ³ / ₈ "	4	3			\$ 1,456	
DW-AF-4818-A-36	Adder	36 ¹ / ₄ "	18"	48"	5 ³ / ₈ "	4	3			\$ 1,044	
DW-AF-6018-S-36	Starter	37 ³ / ₈ "	18"	60"	5 ³ / ₈ "	5	4			\$ 1,550	
DW-AF-6018-A-36	Adder	36 ¹ / ₄ "	18"	60"	5 ³ / ₈ "	5	4			\$ 1,156	
DW-AF-7218-S-36	Starter	37 ³ / ₈ "	18"	72"	5 ³ / ₈ "	6	5			\$ 1,656	
DW-AF-7218-A-36	Adder	36 ¹ / ₄ "	18"	72"	5 ³ / ₈ "	6	5			\$ 1,275	
	A-Frame Shelving, Double Face;										
DW-AF-4824-S-36	Starter	37 ³ / ₈ "	24"	48"	5 ³ / ₈ "	8	6			\$ 2,288	
DW-AF-4824-A-36	Adder	36 ¹ / ₄ "	24"	48"	5 ³ / ₈ "	8	6			\$ 1,644	
DW-AF-6024-S-36	Starter	37 ³ / ₈ "	24"	60"	5 ³ / ₈ "	10	8			\$ 2,375	
DW-AF-6024-A-36	Adder	36 ¹ / ₄ "	24"	60"	5 ³ / ₈ "	10	8			\$ 1,750	
DW-AF-7224-S-36	Starter	37 ³ / ₈ "	24"	72"	5 ³ / ₈ "	12	10			\$ 2,575	
DW-AF-7224-A-36	Adder	36 ¹ / ₄ "	24"	72"	5 ³ / ₈ "	12	10			\$ 1,950	
	A-Frame Shelving, Double Face, Slatwall End Panel;										
DW-AF-4824-S-36-SW	Starter	37 ³ / ₈ "	24"	48"	5 ³ / ₈ "	8	6			\$ 2,431	
DW-AF-4824-A-36-SW	Adder	36 ¹ / ₄ "	24"	48"	5 ³ / ₈ "	8	6			\$ 1,644	
DW-AF-6024-S-36-SW	Starter	37 ³ / ₈ "	24"	60"	5 ³ / ₈ "	10	8			\$ 2,569	
DW-AF-6024-A-36-SW	Adder	36 ¹ / ₄ "	24"	60"	5 ³ / ₈ "	10	8			\$ 1,750	
DW-AF-7224-S-36-SW	Starter	37 ³ / ₈ "	24"	72"	5 ³ / ₈ "	12	10			\$ 2,813	
DW-AF-7224-A-36-SW	Adder	36 ¹ / ₄ "	24"	72"	5 ³ / ₈ "	12	10			\$ 1,950	



Model Shown
DW-AF-4818-S-36



Model Shown
DW-AF-4818-A-36



Model Shown
DW-AF-4824-S-36



Model Shown
DW-AF-4824-A-36



Model Shown
DW-AF-4824-S-36-SW







Model Shown
DW-AF-4824-A-36-SW

SHELVING

MODEL NUMBER	PRODUCT	WIDTH	DEPTH	HEIGHT	WEIGHT	VOLUME	LIST PRICE	DESCRIPTION
S-BA3010E	Bolt Assembly	1"	10 ¹ / ₈ "	30"			\$ 425	
S-BA3610E	Single Face End Panels	1"	10 ¹ / ₈ "	36"	7 Lbs.	0.3 Cu Ft	\$ 444	
S-BA4210E		1"	10 ¹ / ₈ "	42"	8 Lbs.	0.3 Cu Ft	\$ 456	
S-BA4810E		1"	10 ¹ / ₈ "	48"	9 Lbs.	0.3 Cu Ft	\$ 469	
S-BA6010E		1"	10 ¹ / ₈ "	60"	12 Lbs.	0.4 Cu Ft	\$ 494	
S-BA7210E		1"	10 ¹ / ₈ "	72"	14 Lbs.	0.5 Cu Ft	\$ 513	
S-BA8210E		1"	10 ¹ / ₈ "	82"	16 Lbs.	0.6 Cu Ft	\$ 538	
S-BA9610E		1"	10 ¹ / ₈ "	96"	19 Lbs.	0.7 Cu Ft	\$ 563	
S-BA3012E	Bolt Assembly	1"	12 ¹ / ₈ "	30"			\$ 556	
S-BA3612E	Single Face End Panels	1"	12 ¹ / ₈ "	36"	7 Lbs.	0.3 Cu Ft	\$ 588	
S-BA4212E		1"	12 ¹ / ₈ "	42"	8 Lbs.	0.3 Cu Ft	\$ 600	
S-BA4812E		1"	12 ¹ / ₈ "	48"	9 Lbs.	0.3 Cu Ft	\$ 500	
S-BA6012E		1"	12 ¹ / ₈ "	60"	12 Lbs.	0.4 Cu Ft	\$ 525	
S-BA7212E		1"	12 ¹ / ₈ "	72"	14 Lbs.	0.5 Cu Ft	\$ 550	
S-BA8212E		1"	12 ¹ / ₈ "	82"	16 Lbs.	0.6 Cu Ft	\$ 575	
S-BA9612E		1"	12 ¹ / ₈ "	96"	19 Lbs.	0.7 Cu Ft	\$ 600	
S-BA3014E	Bolt Assembly	1"	14 ⁵ / ₈ "	30"			\$ 594	
S-BA3614E	Single Face End Panels	1"	14 ⁵ / ₈ "	36"	7 Lbs.	0.3 Cu Ft	\$ 625	
S-BA4214E		1"	14 ⁵ / ₈ "	42"	8 Lbs.	0.3 Cu Ft	\$ 638	
S-BA4814E		1"	14 ⁵ / ₈ "	48"	9 Lbs.	0.3 Cu Ft	\$ 525	
S-BA6014E		1"	14 ⁵ / ₈ "	60"	12 Lbs.	0.4 Cu Ft	\$ 550	
S-BA7214E		1"	14 ⁵ / ₈ "	72"	14 Lbs.	0.5 Cu Ft	\$ 575	
S-BA8214E		1"	14 ⁵ / ₈ "	82"	16 Lbs.	0.6 Cu Ft	\$ 600	
S-BA9614E		1"	14 ⁵ / ₈ "	96"	19 Lbs.	0.7 Cu Ft	\$ 625	
S-BA3620E	Bolt Assembly	1"	19 ¹ / ₂ "	36"	14 Lbs.	0.6 Cu Ft	\$ 769	
S-BA4220E	Double Face End Panels	1"	19 ¹ / ₂ "	42"	15 Lbs.	0.6 Cu Ft	\$ 788	
S-BA4820E		1"	19 ¹ / ₂ "	48"	18 Lbs.	0.7 Cu Ft	\$ 813	
S-BA6020E		1"	19 ¹ / ₂ "	60"	24 Lbs.	0.8 Cu Ft	\$ 863	
S-BA7220E		1"	19 ¹ / ₂ "	72"	28 Lbs.	1 Cu Ft	\$ 906	
S-BA8220E		1"	19 ¹ / ₂ "	82"	32 Lbs.	1.2 Cu Ft	\$ 956	
S-BA9620E		1"	19 ¹ / ₂ "	96"	38 Lbs.	1.4 Cu Ft	\$ 988	
S-BA3624E	Bolt Assembly	1"	23 ¹ / ₂ "	36"	14 Lbs.	0.6 Cu Ft	\$ 788	
S-BA4224E	Double Face End Panels	1"	23 ¹ / ₂ "	42"	15 Lbs.	0.6 Cu Ft	\$ 813	
S-BA4824E		1"	23 ¹ / ₂ "	48"	18 Lbs.	0.7 Cu Ft	\$ 838	
S-BA6024E		1"	23 ¹ / ₂ "	60"	24 Lbs.	0.8 Cu Ft	\$ 881	
S-BA7224E		1"	23 ¹ / ₂ "	72"	28 Lbs.	1 Cu Ft	\$ 931	
S-BA8224E		1"	23 ¹ / ₂ "	82"	32 Lbs.	1.2 Cu Ft	\$ 981	
S-BA9624E		1"	23 ¹ / ₂ "	96"	38 Lbs.	1.4 Cu Ft	\$ 1,025	
S-BA3628E	Bolt Assembly	1"	28 ¹ / ₂ "	36"	14 Lbs.	0.6 Cu Ft	\$ 863	
S-BA4228E	Double Face End Panels	1"	28 ¹ / ₂ "	42"	15 Lbs.	0.6 Cu Ft	\$ 888	
S-BA4828E		1"	28 ¹ / ₂ "	48"	18 Lbs.	0.7 Cu Ft	\$ 931	
S-BA6028E		1"	28 ¹ / ₂ "	60"	24 Lbs.	0.8 Cu Ft	\$ 994	
S-BA7228E		1"	28 ¹ / ₂ "	72"	28 Lbs.	1 Cu Ft	\$ 1,075	
S-BA8228E		1"	28 ¹ / ₂ "	82"	32 Lbs.	1.2 Cu Ft	\$ 1,144	
S-BA9628E		1"	28 ¹ / ₂ "	96"	38 Lbs.	1.4 Cu Ft	\$ 1,356	



	MODEL NUMBER	PRODUCT	WIDTH	DEPTH	HEIGHT	WEIGHT	VOLUME	LIST PRICE	DESCRIPTION
	S-BAT1024	Bolt Assembly Single Face Top Shelf	23 1/4"	9 3/4"	2 1/2"	7 Lbs.	0.3 Cu Ft	\$ 431	
	S-BAT1224		23 1/4"	11 3/4"	2 1/2"			\$ 444	
	S-BAT1424		23 1/4"	14 1/4"	2 1/2"			\$ 456	
	S-BAT1030		29 1/4"	9 3/4"	2 1/2"			\$ 431	
	S-BAT1230		29 1/4"	11 3/4"	2 1/2"			\$ 444	
	S-BAT1430		29 1/4"	14 1/4"	2 1/2"			\$ 456	
	S-BAT1036		35 1/4"	9 3/4"	2 1/2"	7 Lbs	0.8 Cu Ft	\$ 363	
	S-BAT1236		35 1/4"	11 3/4"	2 1/2"	9 Lbs	0.8 Cu Ft	\$ 375	
	S-BAT1436		35 1/4"	14 1/4"	2 1/2"	10 Lbs	0.8 Cu Ft	\$ 388	
	S-BAT2024	Bolt Assembly Double Face Top Shelf	23 1/4"	9 3/4"	2 1/2"			\$ 619	
	S-BAT2424		23 1/4"	11 3/4"	2 1/2"			\$ 644	
	S-BAT2824		23 1/4"	14 1/4"	2 1/2"			\$ 675	
	S-BAT2030		29 1/4"	9 3/4"	2 1/2"			\$ 619	
	S-BAT2430		29 1/4"	11 3/4"	2 1/2"			\$ 644	
	S-BAT2830		29 1/4"	14 1/4"	2 1/2"			\$ 675	
	S-BAT2036		35 1/4"	9 3/4"	2 1/2"	14 Lbs	1.5 Cu Ft	\$ 513	
	S-BAT2436		35 1/4"	11 3/4"	2 1/2"	16 Lbs	1.5 Cu Ft	\$ 538	
	S-BAT2836		35 1/4"	14 1/4"	2 1/2"	18 Lbs	1.5 Cu Ft	\$ 575	
	S-BAB1024	Bolt Assembly Single Face Bottom Shelf	23 1/4"	9 3/4"	2 1/2"			\$ 450	
	S-BAB1224		23 1/4"	11 3/4"	2 1/2"			\$ 463	
	S-BAB1424		23 1/4"	14 1/4"	2 1/2"			\$ 475	
	S-BAB1030		29 1/4"	9 3/4"	2 1/2"			\$ 450	
	S-BAB1230		29 1/4"	11 3/4"	2 1/2"			\$ 463	
	S-BAB1430		29 1/4"	14 1/4"	2 1/2"			\$ 475	
	S-BAB1036		35 1/4"	9 3/4"	2 1/2"	7 Lbs	0.8 Cu Ft	\$ 375	
	S-BAB1236		35 1/4"	11 3/4"	2 1/2"	9 Lbs	0.8 Cu Ft	\$ 394	
	S-BAB1436		35 1/4"	14 1/4"	2 1/2"	10 Lbs	0.8 Cu Ft	\$ 406	
	S-BAB2024	Bolt Assembly Double Face Bottom Shelf	23 1/4"	9 3/4"	2 1/2"			\$ 650	
	S-BAB2424		23 1/4"	11 3/4"	2 1/2"			\$ 675	
	S-BAB2824		23 1/4"	14 1/4"	2 1/2"			\$ 706	
	S-BAB2030		29 1/4"	9 3/4"	2 1/2"			\$ 650	
	S-BAB2430		29 1/4"	11 3/4"	2 1/2"			\$ 675	
	S-BAB2830		29 1/4"	14 1/4"	2 1/2"			\$ 731	
	S-BAB2036		35 1/4"	9 3/4"	2 1/2"	14 Lbs	1.5 Cu Ft	\$ 538	
	S-BAB2436		35 1/4"	11 3/4"	2 1/2"	16 Lbs	1.5 Cu Ft	\$ 563	
	S-BAB2836		35 1/4"	14 1/4"	2 1/2"	18 Lbs	1.5 Cu Ft	\$ 600	

SHELVING



MODEL NUMBER	PRODUCT	WIDTH	DEPTH	HEIGHT	WEIGHT	VOLUME	LIST PRICE	DESCRIPTION
S-PB30S-24 S-PB30S-30 S-PB30S-36	Printed Backs - Single Face	24"		30"			\$ 63	
		30"		30"			\$ 63	
		36"		30"			\$ 69	
S-PB36S-24 S-PB36S-30 S-PB36S-36		24"		36"	9 Lbs.	0.2 Cu Ft	\$ 63	
		30"		36"			\$ 63	
		36"		36"			\$ 69	
S-PB42S-24 S-PB42S-30 S-PB42S-36		24"		42"			\$ 63	
		30"		42"			\$ 63	
		36"		42"	9 Lbs.	0.2 Cu Ft	\$ 69	
S-PB48S-24 S-PB48S-30 S-PB48S-36		24"		48"			\$ 63	
		30"		48"			\$ 63	
		36"		48"	12 Lbs.	0.3 Cu Ft	\$ 69	
S-PB60S-24 S-PB60S-30 S-PB60S-36		24"		60"			\$ 75	
		30"		60"			\$ 88	
		36"		60"	15 Lbs.	0.3 Cu Ft	\$ 88	
S-PB72S-24 S-PB72S-30 S-PB72S-36		24"		72"			\$ 106	
		30"		72"			\$ 106	
		36"		72"	18 Lbs.	0.4 Cu Ft	\$ 106	
S-PB84S-24 S-PB84S-30 S-PB84S-36		24"		82"			\$ 106	
		30"		82"			\$ 106	
		36"		82"	21 Lbs.	0.4 Cu Ft	\$ 106	
S-PB96S-24 S-PB96S-30 S-PB96S-36		24"		96"			\$ 106	
		30"		96"			\$ 106	
		36"		96"	24 Lbs.	0.5 Cu Ft	\$ 106	



Model Shown
S-PB72D-24

SHELVING

MODEL NUMBER	PRODUCT	WIDTH	DEPTH	HEIGHT	WEIGHT	VOLUME	LIST PRICE	DESCRIPTION
	S-PB30D-24	Printed Backs - Double Face	24"	30"			\$ 75	
	S-PB30D-30		30"	30"			\$ 75	
	S-PB30D-36		36"	30"			\$ 75	
	S-PB36D-24		24"	36"	9 Lbs.	0.2 Cu Ft	\$ 75	
	S-PB36D-30		30"	36"			\$ 75	
	S-PB36D-36		36"	36"			\$ 75	
	S-PB42D-24		24"	42"			\$ 75	
	S-PB42D-30		30"	42"			\$ 75	
	S-PB42D-36		36"	42"	9 Lbs.	0.2 Cu Ft	\$ 75	
Model Shown S-PB72D-24	S-PB48D-24		24"	48"			\$ 75	
	S-PB48D-30		30"	48"			\$ 75	
	S-PB48D-36		36"	48"	12 Lbs.	0.3 Cu Ft	\$ 75	
	S-PB60D-24		24"	60"			\$ 119	
	S-PB60D-30		30"	60"			\$ 119	
	S-PB60D-36		36"	60"	15 Lbs.	0.3 Cu Ft	\$ 119	
	S-PB72D-24		24"	72"			\$ 119	
	S-PB72D-30		30"	72"			\$ 119	
	S-PB72D-36		36"	72"	18 Lbs.	0.4 Cu Ft	\$ 119	
	S-PB84D-24		24"	82"			\$ 119	
	S-PB84D-30		30"	82"			\$ 119	
	S-PB84D-36		36"	82"	21 Lbs.	0.4 Cu Ft	\$ 119	
	S-PB96D-24		24"	96"			\$ 119	
	S-PB96D-30		30"	96"			\$ 119	
	S-PB96D-36		36"	96"	24 Lbs.	0.5 Cu Ft	\$ 119	

	MODEL NUMBER	PRODUCT	WIDTH	DEPTH	HEIGHT	WEIGHT	VOLUME	LIST PRICE	DESCRIPTION	
 <p>Model Shown S-PLSS-3612</p>	S-PLSS-2410	Sloped Continuous Plastic	24"	9 ³ / ₄ "	7"	45 Lbs.	0.6 Cu Ft	\$ 450	Sloped Top option is only available for Shelving units with a height of 36", 42", or 48" Note: With this option the overall height of the unit will increase; 36" increases to 43" 42" increases to 49" 48" increases to 55"	
	S-PLSS-2412	Laminate Top, Single Face	24"	11 ³ / ₄ "	7"			\$ 463		
	S-PLSS-2414		24"	14 ¹ / ₄ "	7"			\$ 475		
	S-PLSS-3010		30"	9 ³ / ₄ "	7"	\$ 450				
	S-PLSS-3012		30"	11 ³ / ₄ "	7"	\$ 463				
	S-PLSS-3014		30"	14 ¹ / ₄ "	7"	\$ 475				
	S-PLSS-3610		36"	9 ³ / ₄ "	7"	\$ 381				
	S-PLSS-3612		36"	11 ³ / ₄ "	7"	\$ 394				
	S-PLSS-3614		36"	14 ¹ / ₄ "	7"	\$ 400				
	 <p>Model Shown S-PLSD-3624</p>	S-PLSD-2420	Sloped Continuous Plastic	24"	19 ¹ / ₄ "	7"	75 Lbs.	17 Cu Ft		\$ 613
		S-PLSD-2424	Laminate Top, Double Face	24"	23 ¹ / ₄ "	7"				\$ 631
		S-PLSD-2428		24"	28 ¹ / ₄ "	7"				\$ 650
S-PLSD-3020			30"	19 ¹ / ₄ "	7"	\$ 613				
S-PLSD-3024			30"	23 ¹ / ₄ "	7"	\$ 631				
S-PLSD-3028			30"	28 ¹ / ₄ "	7"	\$ 650				
S-PLSD-3620			36"	19 ¹ / ₄ "	7"	\$ 544				
S-PLSD-3624			36"	23 ¹ / ₄ "	7"	\$ 563				
S-PLSD-3628			36"	28 ¹ / ₄ "	7"	\$ 575				
			Continuous Top, Square Edge (Beta)				30 Lbs.	0.4 Cu Ft		Single faced tops shall receive edges on 2 short and 1 long edge. Double faced tops shall receive edges on 2 long and 2 short edges. Tops longer than 108" shall be joined together using tight joint fasteners. Suitable for shelving up to 60" high. Prices are given per individual bay. Multiply the list price by the number of bay lengths required.
S-CT36S-B		Single Face				60 Lbs.	0.7 Cu Ft	\$ 206		
S-CT36D-B		Double Face						\$ 306		
		Continuous Top, Bullnose Edge (Ronda)				30 Lbs.	0.4 Cu Ft			
S-CT36S-R	Single Face				60 Lbs.	0.7 Cu Ft	\$ 350			
S-CT36D-R	Double Face						\$ 400			

MODEL NUMBER	PRODUCT	WIDTH	DEPTH	HEIGHT	WEIGHT	VOLUME	LIST PRICE	DESCRIPTION
S-VB30S-24 S-VB30S-30 S-VB30S-36	Veneer Backs - Single Face	24"		30"			\$ 144	
		30"		30"			\$ 144	
		36"		30"			\$ 144	
S-VB36S-24 S-VB36S-30 S-VB36S-36		24"		36"	9 Lbs.	0.2 Cu Ft	\$ 144	
		30"		36"			\$ 144	
		36"		36"			\$ 144	
S-VB42S-24 S-VB42S-30 S-VB42S-36		24"		42"			\$ 144	
		30"		42"			\$ 144	
		36"		42"	9 Lbs.	0.2 Cu Ft	\$ 144	
S-VB48S-24 S-VB48S-30 S-VB48S-36		24"		48"			\$ 144	
		30"		48"			\$ 144	
		36"		48"	12 Lbs.	0.3 Cu Ft	\$ 144	
S-VB60S-24 S-VB60S-30 S-VB60S-36		24"		60"			\$ 219	
		30"		60"			\$ 219	
		36"		60"	15 Lbs.	0.3 Cu Ft	\$ 219	
S-VB72S-24 S-VB72S-30 S-VB72S-36		24"		72"			\$ 219	
		30"		72"			\$ 219	
		36"		72"	18 Lbs.	0.4 Cu Ft	\$ 219	
S-VB82S-24 S-VB82S-30 S-VB82S-36		24"		82"			\$ 219	
		30"		82"			\$ 219	
		36"		82"	21 Lbs.	0.4 Cu Ft	\$ 219	
S-VB96S-24 S-VB96S-30 S-VB96S-36		24"		96"			\$ 219	
		30"		96"			\$ 219	
		36"		96"	24 Lbs.	0.5 Cu Ft	\$ 219	



Model Shown
S-VB72D-24

MODEL NUMBER	PRODUCT	WIDTH	DEPTH	HEIGHT	WEIGHT	VOLUME	LIST PRICE	DESCRIPTION
	S-VB30D-24	Veneer Backs - Double Face	24"	30"			\$ 219	
	S-VB30D-30		30"	30"			\$ 219	
	S-VB30D-36		36"	30"			\$ 219	
	S-VB36D-24		24"	36"	9 Lbs.	0.2 Cu Ft	\$ 219	
	S-VB36D-30		30"	36"			\$ 219	
	S-VB36D-36		36"	36"			\$ 219	
	S-VB42D-24		24"	42"			\$ 219	
	S-VB42D-30		30"	42"			\$ 219	
	S-VB42D-36		36"	42"	9 Lbs.	0.2 Cu Ft	\$ 219	
	S-VB48D-24		24"	48"			\$ 219	
	S-VB48D-30		30"	48"			\$ 219	
	S-VB48D-36		36"	48"	12 Lbs.	0.3 Cu Ft	\$ 219	
	S-VB60D-24		24"	60"			\$ 319	
	S-VB60D-30		30"	60"			\$ 319	
	S-VB60D-36		36"	60"	15 Lbs.	0.3 Cu Ft	\$ 319	
	S-VB72D-24		24"	72"			\$ 319	
	S-VB72D-30		30"	72"			\$ 319	
	S-VB72D-36		36"	72"	18 Lbs.	0.4 Cu Ft	\$ 319	
	S-VB82D-24		24"	82"			\$ 319	
	S-VB82D-30		30"	82"			\$ 319	
	S-VB82D-36		36"	82"	21 Lbs.	0.4 Cu Ft	\$ 319	
	S-VB96D-24		24"	96"			\$ 319	
	S-VB96D-30		30"	96"			\$ 319	
	S-VB96D-36		36"	96"	24 Lbs.	0.5 Cu Ft	\$ 319	

Model Shown
S-VB72D-24

MODEL NUMBER	PRODUCT	WIDTH	DEPTH	HEIGHT	WEIGHT	VOLUME	LIST PRICE	DESCRIPTION
	S-FB-V-30-24	24"		30"			\$ 456	
	S-FB-V-30-30	30"		30"			\$ 456	
	S-FB-V-30-36	36"		30"			\$ 456	
	S-FB-V-36-24	24"		36"	9 Lbs.	0.2 Cu Ft	\$ 456	
	S-FB-V-36-30	30"		36"			\$ 456	
	S-FB-V-36-36	36"		36"			\$ 456	
	S-FB-V-42-24	24"		42"			\$ 456	
	S-FB-V-42-30	30"		42"			\$ 456	
	S-FB-V-42-36	36"		42"	9 Lbs.	0.2 Cu Ft	\$ 456	
	S-FB-V-48-24	24"		48"			\$ 456	
	S-FB-V-48-30	30"		48"			\$ 456	
	S-FB-V-48-36	36"		48"	12 Lbs.	0.3 Cu Ft	\$ 456	
	S-FB-V-60-24	24"		60"			\$ 575	
	S-FB-V-60-30	30"		60"			\$ 575	
	S-FB-V-60-36	36"		60"	15 Lbs.	0.3 Cu Ft	\$ 575	
	S-FB-V-72-24	24"		72"			\$ 575	
	S-FB-V-72-30	30"		72"			\$ 575	
	S-FB-V-72-36	36"		72"	18 Lbs.	0.4 Cu Ft	\$ 575	
	S-FB-V-82-24	24"		82"			\$ 575	
	S-FB-V-82-30	30"		82"			\$ 575	
	S-FB-V-82-36	36"		82"	21 Lbs.	0.4 Cu Ft	\$ 575	
	S-FB-V-96-24	24"		96"			\$ 575	
	S-FB-V-96-30	30"		96"			\$ 575	
	S-FB-V-96-36	36"		96"	24 Lbs.	0.5 Cu Ft	\$ 575	

Model Shown
S-FB-V-72-24

MODEL NUMBER	PRODUCT	WIDTH	DEPTH	HEIGHT	WEIGHT	VOLUME	LIST PRICE	DESCRIPTION
S-FB-C-30-24 S-FB-C-30-30 S-FB-C-30-36	Finished Back Cork Option	24"		30"			\$ 669	
		30"		30"			\$ 669	
		36"		30"			\$ 669	
S-FB-C-36-24 S-FB-C-36-30 S-FB-C-36-36		24"		36"	9 Lbs.	0.2 Cu Ft	\$ 669	
		30"		36"			\$ 669	
		36"		36"			\$ 669	
S-FB-C-42-24 S-FB-C-42-30 S-FB-C-42-36		24"		42"			\$ 669	
		30"		42"			\$ 669	
		36"		42"	9 Lbs.	0.2 Cu Ft	\$ 669	
S-FB-C-48-24 S-FB-C-48-30 S-FB-C-48-36		24"		48"			\$ 669	
		30"		48"			\$ 669	
		36"		48"	12 Lbs.	0.3 Cu Ft	\$ 669	
S-FB-C-60-24 S-FB-C-60-30 S-FB-C-60-36		24"		60"			\$ 950	
		30"		60"			\$ 950	
		36"		60"	15 Lbs.	0.3 Cu Ft	\$ 950	
S-FB-C-72-24 S-FB-C-72-30 S-FB-C-72-36		24"		72"			\$ 950	
		30"		72"			\$ 950	
		36"		72"	18 Lbs.	0.4 Cu Ft	\$ 950	
S-FB-C-82-24 S-FB-C-82-30 S-FB-C-82-36		24"		82"			\$ 950	
		30"		82"			\$ 950	
		36"		82"	21 Lbs.	0.4 Cu Ft	\$ 950	
S-FB-C-96-24 S-FB-C-96-30 S-FB-C-96-36		24"		96"			\$ 950	
		30"		96"			\$ 950	
		36"		96"	24 Lbs.	0.5 Cu Ft	\$ 950	







Model Shown
S-FB-C-72-24



MODEL NUMBER	PRODUCT	WIDTH	DEPTH	HEIGHT	WEIGHT	VOLUME	LIST PRICE	DESCRIPTION
S-FB-S-30-24 S-FB-S-30-30 S-FB-S-30-36	Finished Back Slotwall Option	24"		30"			\$ 813	
		30"		30"			\$ 813	
		36"		30"			\$ 813	
S-FB-S-36-24 S-FB-S-36-30 S-FB-S-36-36		24"		36"	9 Lbs.	0.2 Cu Ft	\$ 813	
		30"		36"			\$ 813	
		36"		36"			\$ 813	
S-FB-S-42-24 S-FB-S-42-30 S-FB-S-42-36		24"		42"	9 Lbs.	0.2 Cu Ft	\$ 813	
		30"		42"			\$ 813	
		36"		42"			\$ 813	
S-FB-S-48-24 S-FB-S-48-30 S-FB-S-48-36		24"		48"	12 Lbs.	0.3 Cu Ft	\$ 813	
		30"		48"			\$ 813	
		36"		48"			\$ 813	
S-FB-S-60-24 S-FB-S-60-30 S-FB-S-60-36		24"		60"	15 Lbs.	0.3 Cu Ft	\$ 1,288	
		30"		60"			\$ 1,288	
		36"		60"			\$ 1,288	
S-FB-S-72-24 S-FB-S-72-30 S-FB-S-72-36		24"		72"	18 Lbs.	0.4 Cu Ft	\$ 1,288	
		30"		72"			\$ 1,288	
		36"		72"			\$ 1,288	
S-FB-S-82-24 S-FB-S-82-30 S-FB-S-82-36		24"		82"	21 Lbs.	0.4 Cu Ft	\$ 1,288	
		30"		82"			\$ 1,288	
		36"		82"			\$ 1,288	
S-FB-S-96-24 S-FB-S-96-30 S-FB-S-96-36		24"		96"	24 Lbs.	0.5 Cu Ft	\$ 1,288	
		30"		96"			\$ 1,288	
		36"		96"			\$ 1,288	







Model Shown
S-FB-S-72-24

SHELVING

	MODEL NUMBER	PRODUCT	WIDTH	DEPTH	HEIGHT	WEIGHT	VOLUME	LIST PRICE	DESCRIPTION
	W-S10-24	24" Wide Standard Wood Shelf	23 1/4"	9 1/2"	3 3/8"			\$ 100	
	W-S12-24		23 1/4"	11 1/2"	3 3/8"			\$ 113	
	W-S14-24		23 1/4"	14"	3 3/8"			\$ 138	
Model Shown DW-S12-36	W-S10-30	30" Wide Standard Wood Shelf	29 1/4"	9 1/2"	3 3/8"			\$ 100	
	W-S12-30		29 1/4"	11 1/2"	3 3/8"			\$ 113	
	W-S14-30		29 1/4"	14"	3 3/8"			\$ 138	
	W-S10-36	36" Wide Standard Wood Shelf	35 1/4"	9 1/2"	3 3/8"	6 Lbs.	0.2 Cu Ft	\$ 94	
	W-S12-36		35 1/4"	11 1/2"	3 3/8"	7 Lbs.	0.2 Cu Ft	\$ 106	
	W-S14-36		35 1/4"	14"	3 3/8"	8 Lbs.	0.2 Cu Ft	\$ 131	
	W-V10-24	24" Wide Veneered Shelf	23 1/4"	9 1/2"	3 3/8"			\$ 119	
	W-V12-24		23 1/4"	11 1/2"	3 3/8"			\$ 144	
	W-V14-24		23 1/4"	14"	3 3/8"			\$ 169	
Model Shown DW-V12-36	W-V10-30	30" Wide Veneered Shelf	29 1/4"	9 1/2"	3 3/8"			\$ 119	
	W-V12-30		29 1/4"	11 1/2"	3 3/8"			\$ 144	
	W-V14-30		29 1/4"	14"	3 3/8"			\$ 169	
	W-V10-36	36" Wide Veneered Shelf	35 1/4"	9 1/2"	3 3/8"	6 Lbs.	0.2 Cu Ft	\$ 119	
	W-V12-36		35 1/4"	11 1/2"	3 3/8"	7 Lbs.	0.2 Cu Ft	\$ 138	
	W-V14-36		35 1/4"	14"	3 3/8"	8 Lbs.	0.2 Cu Ft	\$ 156	
	G10-24	24" Wide Glass Shelf	23 1/4"	9 1/2"				\$ 131	
	G12-24		23 1/4"	11 1/2"				\$ 131	
	G14-24		23 1/4"	14"				\$ 131	
Model Shown DW-V12-36	G10-30	30" Wide Glass Shelf	29 1/4"	9 1/2"				\$ 138	
	G12-30		29 1/4"	11 1/2"				\$ 138	
	G14-30		29 1/4"	14"				\$ 138	
	G10-36	36" Wide Glass Shelf	35 1/4"	9 1/2"				\$ 144	
	G12-36		35 1/4"	11 1/2"				\$ 144	
	G14-36		35 1/4"	14"				\$ 144	
	W-M12-24	24" Wide Wood Magazine Shelf	23 1/8"	2"	12"			\$ 200	
	W-M14-24		23 1/8"	2"	14"			\$ 231	
	W-M12-30	30" Wide Wood Magazine Shelf	29 1/8"	2"	12"			\$ 200	
Model Shown DW-M12-36	W-M14-30		29 1/8"	2"	14"			\$ 231	
	W-M12-36	36" Wide Wood Magazine Shelf	35 1/8"	2"	12"	13 Lbs.	6 Cu Ft	\$ 194	
	W-M14-36		35 1/8"	2"	14"	14 Lbs.	6 Cu Ft	\$ 219	

	MODEL NUMBER	PRODUCT	WIDTH	DEPTH	HEIGHT	WEIGHT	VOLUME	LIST PRICE	DESCRIPTION
 <p>Model Shown DW-P12-36</p>	W-P12-24	Wood Picture Book Shelf	23 1/4"	11 1/4"	9 3/4"	15 Lbs.	2 Cu Ft	\$ 225	
	W-P12-30		29 1/4"	11 1/4"	9 3/4"			\$ 225	
	W-P12-36		35 1/4"	11 1/4"	9 3/4"			\$ 213	
	S-SWS08	Slot Wall Display Shelves	8"	3 1/2"	5 1/2"			1 Lbs.	
S-SWS16	16"		3 1/2"	5 1/2"	1.5 Lbs.	0.1 Cu Ft	\$ ____		
S-SWS32	32"		3 1/2"	5 1/2"	2.5 Lbs.	0.1 Cu Ft	\$ ____		
 <p>Model Shown DW-GSB</p>	W-GSB	Wood Grooved Bottom Shelf Option						\$ 31	







	MODEL NUMBER	PRODUCT	WIDTH	DEPTH	HEIGHT	WEIGHT	VOLUME	LIST PRICE	DESCRIPTION
	S-FPS	Top Filler Panel, Single Face				2 Lbs.	0.1 Cu Ft	\$ 163	
	S-FPD	Top Filler Panel, Double Face				4 Lbs.	0.1 Cu Ft	\$ 269	
	S-FPT	Top Filler Panel, Tristar				5 Lbs.	0.1 Cu Ft	\$ 363	
	S-FPF	Front Filler Panel				5 Lbs.	0.1 Cu Ft	\$ 388	

SHELVING

MODEL NUMBER	PRODUCT	WIDTH	DEPTH	HEIGHT	WEIGHT	VOLUME	LIST PRICE	DESCRIPTION
S-MS3624	Mobile Shelving Bottom Frame (Max 60" H Shelving)	36"	24"				\$ 475	



SHELVING

	MODEL NUMBER	PRODUCT	WIDTH	DEPTH	HEIGHT	WEIGHT	VOLUME	LIST PRICE	DESCRIPTION
	W-CDS	Clip-on Dividers for Wood Shelves	4 1/2"		5 1/2"	0.5 Lbs.	0.1 Cu Ft	\$ 31	
	W-CDL		7 1/2"		6 1/2"	0.5 Lbs.	0.1 Cu Ft	\$ 38	
	PD-01	Pendent Divider for Wood Shelves				0.5 Lbs.	0.1 Cu Ft	\$ 19	
	M-BE6	Metal Book End	5"	5"	6"	0.8 Lbs.	0.1 Cu Ft	\$ 19	
	M-BE9		5"	5"	9"	1 Lbs.	0.1 Cu Ft	\$ 25	
									
	S-H35	Hanging Kick Bag Rod	35 1/4"	3/8"	3/8"	6 Lbs.	0.1 Cu Ft	\$ 194	
	S-140	Wall Mounted Newspaper Rack	35 1/4"	12"	30 1/2"	40 Lbs.	9 Cu Ft	\$ 763	
	G-NS	Newspaper Stick	34"	3/4"		0.5 Lbs.	0.1 Cu Ft	\$ 88	

SHELVING

Palmieri Furniture Limited ("Palmieri") warrants that its products and collections are free from defects in materials and workmanship for the life of the product, except as set forth below. Palmieri Limited Lifetime Warranty is valid from the date of delivery.

Exceptions to the Limited Lifetime Warranty: Seating: two (2) years

Goods sold hereunder are covered by a Limited Lifetime Warranty, free against defects in material and workmanship provided the goods and services are subjected to normal use and service. The applicable warranty period commences from shipping date to Purchaser of any item of the goods, whichever occurs first, or any other warranty period otherwise stipulated in writing by Palmieri under this sale. For components not supplied by Palmieri, the original manufacturer's warranty shall apply to the extent assignable by Palmieri. The obligation under this warranty is limited to the repair or replacement, at Palmieri's option, of defective parts F.O.B. point of shipment provided that prompt notice of any defect is given by Purchaser to Palmieri in writing within the applicable warranty period and that upon the Purchaser's return of the defective parts to Palmieri or, if designated by Palmieri, to the location where the works are made, properly packed and with transportation charges prepaid by Purchaser, an inspection thereof shall reveal to Palmieri's satisfaction that Purchaser's claim is valid under the terms of this warranty. Purchaser shall assume all responsibility and expense for dismantling, removal, re-installation and freight in connection with the foregoing. The same obligations and conditions extend to replacement parts furnished by Palmieri hereunder.

Palmieri does not assume liability for installation, labour or consequential damages. Palmieri makes no warranty other than the one set forth herein. All other warranties, legal, expressed or implied, including but not limited to any expressed or implied warranty of merchantability, of fitness for the intended use thereof or against infringement are hereby expressly excluded. The applicable warranty ceases to be effective if the goods are altered or repaired other than by persons authorized or approved by Palmieri to perform such work. Repairs or replacement deliveries do not interrupt or prolong the term of the warranty. The warranty ceases to be effective if Purchaser fails to handle and use the goods sold hereunder in a safe and reasonable manner and in accordance with any written instructions from the manufacturers.

Warranty Does Not Apply To Product Failure Or Loss Resulting From:

Abuse, misuse or accident, alteration or modification of product by customer or third party, normal wear and tear, improper installation, handling or incorrect use. The substitution of part components or hardware not approved or authorized by Palmieri, acts of God, unauthorized repairs, improper storage, and environmental conditions such as irregular temperature control either inside or outside the environment.

Warranty Provides Exclusive Remedies:

If a product fails under ordinary use as a result of a defect in material or workmanship, Palmieri will: (A) repair, or (B) replace the furniture. The replacement or repair of the Furniture or Seating will be at the discretion of Palmieri. If the defect or workmanship cannot be remedied on site, repairs can be made at the factory. (C) If the product repair or replacement is not commercially practicable or cannot be remade in a timely manner Palmieri will refund the purchase price of the affected product. A product "**Defect**" means: an inadequacy in the materials or workmanship of the product that (A) existed at the time when you received the product from Palmieri or Palmieri authorized Reseller and (B) causes a failure of the product to perform under ordinary use in accordance with the materials and documentation accompanying the product. "**Ordinary Use**" means: use of the product (A) in accordance with all applicable local, state or federal laws, codes and regulations and (B) in accordance with manufacturer recommendations and or instructions in the materials and documentation accompanying the product or through shop drawings. A "**Palmieri Authorized Reseller**" means: any dealer that is legally permitted to conduct business in the jurisdiction where the product is sold and is duly authorized by Palmieri to sell the product.

Warranty work must be approved by authorized personnel of Palmieri Furniture Limited in Richmond Hill, Ontario, Canada.

A copy of the original purchase order must accompany all claims.

Warranty Does Not Cover:

Matching of colours, stains, textures, grains and any other variations in materials. Select and Custom Surfaces and materials are only warranted for their application on the specified product and are not covered by our warranty, except as warranted by the original supplier, for quality, colorfastness, shade variations or abrasion and textiles purchased for Palmieri product.

This limited warranty is the sole remedy for product defect and no other express or implied warranty is provided. Warranty is not transferable and valid only for the original purchaser acquiring a product from Palmieri or a Palmieri authorized reseller for the purchaser's own use and not for resale, remarketing or distribution. Limited Lifetime Warranty (25 years)

GENERAL

The following Terms and Conditions of Quote and Sale shall apply to any sale of goods and services by Palmieri Furniture Limited (hereinafter called "Palmieri"). Purchaser shall be deemed to have full knowledge of the terms and conditions herein and such terms and conditions shall be binding if either the goods and services referred to herein are delivered to and accepted by Purchaser, or if Purchaser does not within five (5) days from the date hereof deliver to Palmieri written objection to said terms and conditions or any part thereof.

In the event of any conflict or inconsistency between the terms and conditions of sale herein and the terms and conditions contained in Purchaser's order or in any other form issued by Purchaser, whether or not any such form has been acknowledged or accepted by Palmieri, Palmieri's terms and conditions herein shall prevail. No waiver, alteration or modification of these terms and conditions shall be binding upon Palmieri unless made in writing and signed by a duly authorized representative of Palmieri.

1. QUOTATIONS / PRODUCT QUOTED

Unless otherwise stated, **Palmieri's quotations shall be null and void unless accepted by Purchaser within thirty (30) days from the date of quotation.** Quotes may be subject to change before order placement, due to increased material costs and or other factors that could impact the final cost of production and our final understanding of the product required. If the items quoted do not reflect the intended product requirements of the customer, Palmieri will not be held responsible for increased costs for those product changes. We reserve the right to edit or re-quote any portion of a previously submitted quotation subject to our final understanding of the product required by the client.

2. PALMIERI DRAWINGS

Palmieri provides drawings for Custom & Standard product we produce to our clients upon request. We consider these drawings to be Private and Confidential and are provided for the sole purpose and use of our clients to understand the product we are providing. The use of these confidential materials is limited to the transaction between the parties and at no point are these confidential materials to be sent to any of our competitors or parties quoting for the same purpose.

A minimum \$85.00 NET Engineering Administrative Fee will apply for Custom Product Drawings

(Note: The first set of Custom product drawings will be free of charge)

A minimum \$120.00 NET Engineering Administrative Fee will apply for all Standard Product Drawings

3. TERMS OF PAYMENT

For authorized customers; Orders at a \$75,000.00 threshold will require a mandatory 25% deposit. Orders over and above \$100,000.00 requires a mandatory (25%) deposit at time of order, a mandatory (25%) deposit prior to product shipment and the balance to be paid within thirty (30) days of date of shipment. Payment not be made to Palmieri when due, Palmieri reserves the right to charge Purchaser with interest on such overdue payments. Interest of 2% per month (24% per annum) is charged on all overdue accounts, unless otherwise specified. The charging of such interest shall not be construed as obligating Palmieri to grant any extension of time in the terms of payment. All goods remain the property of Palmieri, until balance is paid in full to Palmieri.

4. TITLE

Title to the goods or any part thereof shall not pass from Palmieri to Purchaser until all payments due hereunder have been duly made, except as otherwise expressly stipulated herein. The goods shall be and remain personal or moveable property, notwithstanding their mode of attachment to realty or other property. If default is made in any of the payments herein, Purchaser agrees that Palmieri may retain all payments which have been made on account of the purchase price as liquidated damages, and Palmieri shall be free to enter the premises where the goods may be located and remove them as Palmieri's property, without prejudice to Palmieri's right to recover any further expenses or damages Palmieri may suffer by reason of such nonpayment.

5. TAXES

Prices do not include Goods & Services Tax, Provincial or Municipal sales, use, value-added or similar tax. All applicable taxes are extra. Our Harmonized Sales Tax (HST) registration number is R104055066.

6. THE AGREEMENT

An acceptance and official confirmation of Purchasers' order by signing Palmieri's Order Confirmation the Purchaser therefore is accepting terms and conditions as expressed herein Palmieri's Terms and Conditions of Quote and Sale by Palmieri and shall constitute the complete agreement, subject to the terms and conditions of sale herein set forth, and shall supersede all previous quotations, orders or agreements.

7. LEAD TIME / DELIVERY / DELAYS

Lead time is determined only when final material/finish selection and drawing approvals are received by Palmieri from the client. The accuracy of Palmieri's lead times, is created to the best of our ability with the information provided to us. Confirmed lead time is conveyed to the client by means of Order Confirmation. They do not preclude the client from checking the accuracy of your requirement and our Order Confirmation. Any noted discrepancies are to be reported immediately to Palmieri Customer Service Department for correction and re-issue of revised Order Confirmation. By signing and dating the Order Confirmation the client accepts the terms and conditions of quote and sale.

Lead time on our Order Confirmation do not account for delays that could potentially occur for special materials specified by the client that are outside of our standard finishes and materials program that are out of our control

and will affect the lead time on the order. Palmieri will notify the client immediately when these delays occur and adjust the lead time accordingly.

Delivery schedules are approximate and are based on prevailing market conditions applicable respectively at the time of Palmieri's quotation and Palmieri's acceptance of clients' order, if certain portions of an order are completed by the quoted lead time while other portions have experienced delays outside of our control. The client may choose to part ship the order at their discretion and expense. Otherwise the entire order will ship with the delayed portion at a later date. Palmieri may extend delivery schedules or may, at its option, cancel Purchaser's order in full or in part without liability other than to return any deposit or prepayment which is unearned by reason of the cancellation.

8. CHANGES AND CANCELLATION

Orders accepted by Palmieri are not subject to changes or cancellation by Purchaser without the written consent of Palmieri. In such cases where Palmieri authorizes changes or cancellation, Palmieri reserves the right to charge the Purchaser with reasonable costs based upon expenses already incurred and commitments made by Palmieri, including, without limitation, any labour done, material purchased and also including Supplier's usual overhead and reasonable profit and cancellation charges from Palmieri's suppliers. Palmieri will communicate to the Purchaser additional costs incurred by way of Revised Order Confirmation. Revised Order Confirmation will include applicable costs incurred and modification to lead times (if applicable). The Purchaser must provide Palmieri written confirmation of additional costs, before any changes can be processed on the order.

A minimum charge of \$100.00 NET Change Order Request fee will apply

A minimum charge of \$150.00 NET Cancel Order Request fee will apply.

9. SHIPPING LOCATION / SHIPPING QUOTES / COST OF TRANSPORTATION

Unless otherwise stated, all prices are F.O.B. our factory in Richmond Hill, Ontario, Canada.

Customary methods of transportation shall be selected by Palmieri and such transportation will be at Purchaser's expense. Shipping quotations are made at time of furniture quotation and are outside the control of Palmieri. **Shipping quotes are valid for ten (10) business days from the time of quote.** We do our best to maintain shipping costs as quoted, however all shipping weights and cubic feet shown are approximate only, various construction materials and packaging methods may add to the weights given. All quoted prices, unless otherwise stated on the quotation, are based on the current exchange rates, tariffs, fuel surcharges and costs of manufacture and are subject to change by Palmieri with or without notice until Purchaser's acceptance. Palmieri does not assume responsibility or liability for shipping costs, product during transit, or variances from the shipping weights or cubic feet shown in our specification guides. Special methods of transportation will be used upon Purchaser's request and at Purchaser's additional expense, provided reasonable notice of Purchaser's transportation requirements are given by Purchaser to Palmieri prior to shipment. Palmieri will notify the client prior to shipping product if shipping costs as quoted change, at which point the client must approve the adjusted shipping costs.

10. RECEIVING PRODUCT / REPORTING DAMAGE / STORAGE OF PRODUCT

Upon receipt of Palmieri product, the receiver of the goods must immediately inspect the product to ensure it is free of shipping damage. If the product is deemed in good order, the receiver of the product must ensure

to sign off on the accompanying carriers Bill of lading in good condition. Except for obligations stated under "Warranty" herein, Palmieri's responsibility for the product ceases once the product has been received and signed off in good order and is the full responsibility of the receiver and subsequently the owner.

In the event shipping damage is discovered during receipt of shipment, it is the responsibility of the receiver to ensure all noted damage is recorded on the carrier's Bill of Lading prior to sign off. All noted shipping damage claims must be reported to Palmieri within **24 hours** of receipt of the product onsite, failure to do so will result in the claim being deemed null and void. All shipping damage claims are to be reported directly to Palmieri's Shipping Manager. Please call our toll free number at **1-800-413-4440 ext. 33** or submit the claim by Fax directly to **1-905-731-9878**. Palmieri will not accept any shipping damage claims submitted **after 24 hours** and it shall be conclusively presumed that the goods were delivered in good condition.

Storage of product, Palmieri will not be held responsible for any potential damages or shortages for product shipped and received by Purchaser and is subsequently placed into storage and not inspected within 24 hours of receipt.

11. INSTALLATION / SHORTAGES / BACK CHARGES

Unless otherwise expressly stipulated, the goods shall be installed by and at the risk and expense of Purchaser.

In the event that Palmieri is requested to supervise such installation, Palmieri's responsibility shall be limited to exercising that degree of skill customary in the trade in supervising installations of the same type. Purchaser shall remain responsible for all other aspects of the work including compliance with the local regulations. It is the responsibility of the Purchaser to ensure hardware and parts are received in good order. Packing slip and hardware list to be provided by Palmieri with every order at time of shipping. Purchaser has the responsibility to notify Palmieri immediately without delay of issues that arise; subsequently Palmieri will take action to provide prompt resolution.

Shortages must be reported to Palmieri within **24 hours** of receipt of the goods and failure to do so may be at the expense of the Purchaser.

If deemed missing hardware and parts short shipped from the factory, Palmieri will arrange to ship freight prepaid to destination. Palmieri will only be responsible for replacement costs of missing hardware and parts, any labour costs incurred will be the responsibility of the Purchaser and will not be approved by Palmieri.

Back Charges will only be approved if we deemed a defect in the material or workmanship is found during the installation period resulting in a return trip to the job-site to complete installation. It shall remain the sole discretion of Palmieri to approve (A) repair or (B) replace the furniture and any labour costs incurred by the Purchaser.

12. FORCE MAJEURE

Palmieri shall not be responsible or liable for any loss or damage incurred by Purchaser herein resulting from causes beyond the reasonable control of Palmieri including, but without limitation, abuse, misuse or accident, alteration or modification of product by customer or third party, normal wear and tear, improper installation, handling or incorrect use, unauthorized repairs, the substitution of part components or hardware not approved or authorized by Palmieri, improper storage, and environmental conditions such as irregular temperature control

either inside or outside the environment, acts of God, fire, flood, delays in transportation, or the failure of Palmieri's suppliers to meet their delivery promises. The acceptance of delivery of the goods by Purchaser shall constitute a waiver of all claims for loss or damage due to any delay whatsoever.

13. RETURNED GOODS

No goods may be returned to Palmieri for a credit or exchanged without Palmieri's prior written consent.

Palmieri reserves the right to accept all returns and subject to a handling/restocking charge or to decline all returns. Even after Palmieri has authorized the return of goods for credit, Palmieri reserves the right to adjust the amount of any credit given to Purchaser on return of the goods based on the conditions of the goods on arrival in Palmieri's warehouse. Credit for returned goods will be issued to Purchaser only where such goods are returned by Purchaser and not by any subsequent owner of the goods. Goods will be considered for return only if they are in their original condition and packaging. Palmieri Goods Return Authorization Form to be issued and **must** accompany all shipments returning back to the factory. **Return freight must be prepaid by Purchaser. A minimum 20% re-stocking fee will apply.**

1230 Reid Street
Richmond Hill
Ontario Canada
L4B 1C4

T 905 731 9300
F 905 731 9878
TF 800 413 4440

info@palmierifurniture.com
www.PalmieriFurniture.com

SPECIFICATION GUIDE & PRICE LIST

2017

PALMIER

SHELVING

TREK METAL

CATEGORY: LIBRARY FURNITURE
CONTRACT: BID #ESCNJ 17/18-16

Introduction	1
Table of Contents	2-3
Product Materials & Finishes	4-5

Trek Metal Shelving 6-29

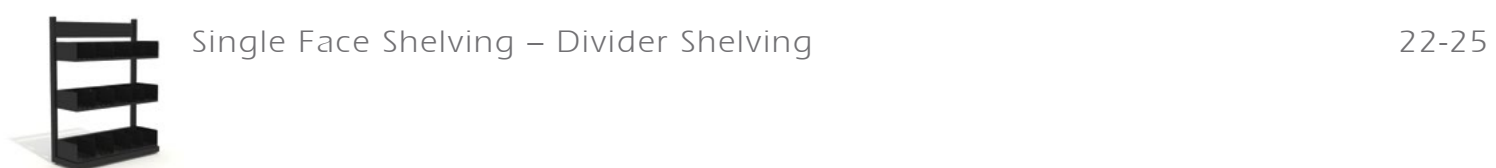
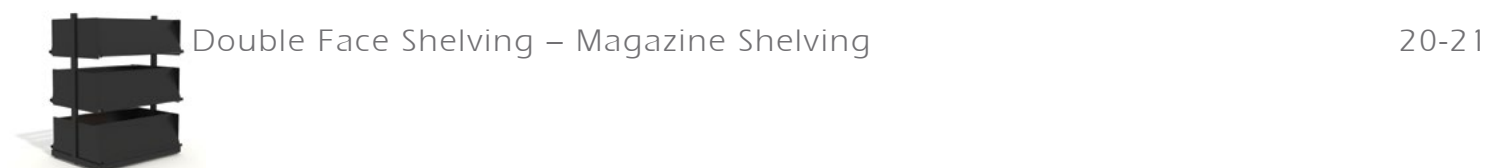
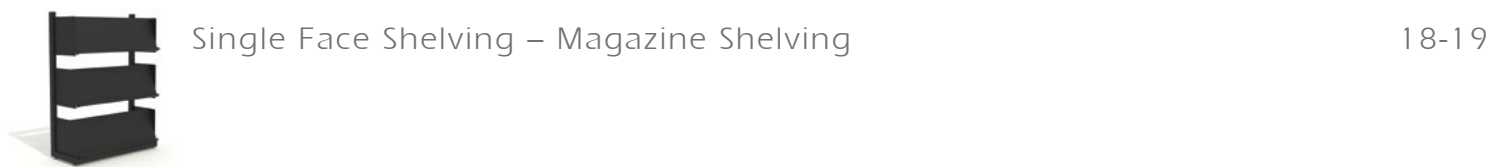
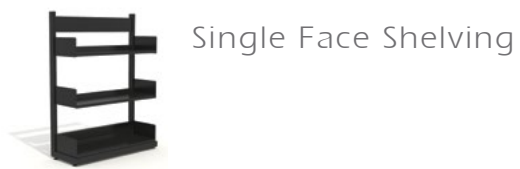

Components & Accessories 30-41

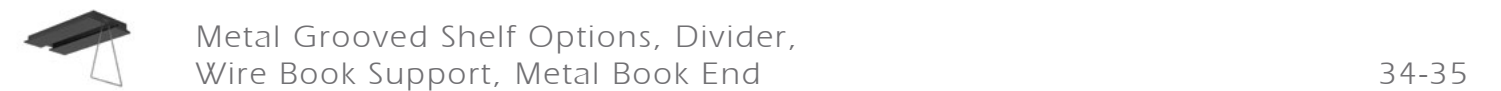

Warranty 40

Terms & Conditions 41

METAL PAINT:

Thermal Paint Colours



White
PS-111-W374



Antique White
W11



Beige
H23

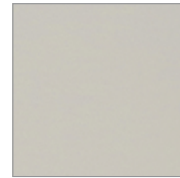

Desert
H432



Red
R66



Ruby
R7



Blue
B11



Navy
B17

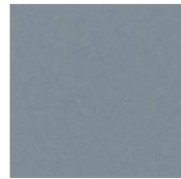

Zinc
A67



Hydro Green
G96



Green
G58



Grey
A16



Charcoal
A230



Black
N49



Pebble
M237

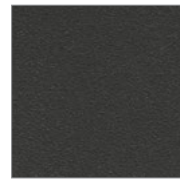

Black Sandtex
N31



Sparkling Silver
S11

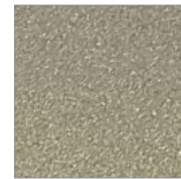

Champagne
S14

METAL FINISHING PROCEDURES: All metal components are thoroughly cleaned and coated electrostatically with an epoxy powder coat paint finish. The metal components are then oven baked and cured for a lasting finish.

MODEL NUMBER	PRODUCT	WIDTH	DEPTH	HEIGHT	SHELF DEPTH	# OF SHELVES	# OF OPENINGS	WEIGHT	VOLUME	LIST PRICE	DESCRIPTION
--------------	---------	-------	-------	--------	-------------	--------------	---------------	--------	--------	------------	-------------









Model Shown
TR-4812-S-36



Model Shown
TR-4812-A-36

TR-4210-S-24	Single Face Shelving	24 ³ / ₄ "	10"	42"	9 ¹ / ₂ "	3	3			\$ 906	Made of a 1-1/4" x 2" metal frame with powder coat paint. METAL FINISHING: All metal components are thoroughly cleaned and coated electrostatically with an epoxy powder coat paint finish. The metal components are then oven baked and cured for a lasting finish.
TR-4210-A-24	Single Face Adder	23 ¹ / ₂ "	10"	42"	9 ¹ / ₂ "	3	3			\$ 725	
TR-4212-S-24	Single Face Shelving	24 ³ / ₄ "	12"	42"	11 ¹ / ₂ "	3	3			\$ 931	
TR-4212-A-24	Single Face Adder	23 ¹ / ₂ "	12"	42"	11 ¹ / ₂ "	3	3			\$ 744	
TR-4214-S-24	Single Face Shelving	24 ³ / ₄ "	14"	42"	14"	3	3			\$ 950	
TR-4214-A-24	Single Face Adder	23 ¹ / ₂ "	14"	42"	14"	3	3			\$ 763	
TR-4210-S-30	Single Face Shelving	30 ³ / ₄ "	10"	42"	9 ¹ / ₂ "	3	3			\$ 906	
TR-4210-A-30	Single Face Adder	29 ¹ / ₂ "	10"	42"	9 ¹ / ₂ "	3	3			\$ 725	
TR-4212-S-30	Single Face Shelving	30 ³ / ₄ "	12"	42"	11 ¹ / ₂ "	3	3			\$ 931	
TR-4212-A-30	Single Face Adder	29 ¹ / ₂ "	12"	42"	11 ¹ / ₂ "	3	3			\$ 744	
TR-4214-S-30	Single Face Shelving	30 ³ / ₄ "	14"	42"	14"	3	3			\$ 950	
TR-4214-A-30	Single Face Adder	29 ¹ / ₂ "	14"	42"	14"	3	3			\$ 763	
TR-4210-S-36	Single Face Shelving	36 ³ / ₄ "	10"	42"	9 ¹ / ₂ "	3	3	54 Lbs.	__ Cu Ft	\$ 875	
TR-4210-A-36	Single Face Adder	35 ¹ / ₂ "	10"	42"	9 ¹ / ₂ "	3	3	46 Lbs.	__ Cu Ft	\$ 694	
TR-4212-S-36	Single Face Shelving	36 ³ / ₄ "	12"	42"	11 ¹ / ₂ "	3	3	55 Lbs.	__ Cu Ft	\$ 900	
TR-4212-A-36	Single Face Adder	35 ¹ / ₂ "	12"	42"	11 ¹ / ₂ "	3	3	47 Lbs.	__ Cu Ft	\$ 706	
TR-4214-S-36	Single Face Shelving	36 ³ / ₄ "	14"	42"	14"	3	3	58 Lbs.	__ Cu Ft	\$ 919	
TR-4214-A-36	Single Face Adder	35 ¹ / ₂ "	14"	42"	14"	3	3	52 Lbs.	__ Cu Ft	\$ 725	
TR-4810-S-24	Single Face Shelving	24 ³ / ₄ "	10"	48"	9 ¹ / ₂ "	3	3			\$ 931	
TR-4810-A-24	Single Face Adder	23 ¹ / ₂ "	10"	48"	9 ¹ / ₂ "	3	3			\$ 744	
TR-4812-S-24	Single Face Shelving	24 ³ / ₄ "	12"	48"	11 ¹ / ₂ "	3	3			\$ 950	
TR-4812-A-24	Single Face Adder	23 ¹ / ₂ "	12"	48"	11 ¹ / ₂ "	3	3			\$ 763	
TR-4814-S-24	Single Face Shelving	24 ³ / ₄ "	14"	48"	14"	3	3			\$ 975	
TR-4814-A-24	Single Face Adder	23 ¹ / ₂ "	14"	48"	14"	3	3			\$ 781	
TR-4810-S-30	Single Face Shelving	30 ³ / ₄ "	10"	48"	9 ¹ / ₂ "	3	3			\$ 931	
TR-4810-A-30	Single Face Adder	29 ¹ / ₂ "	10"	48"	9 ¹ / ₂ "	3	3			\$ 744	
TR-4812-S-30	Single Face Shelving	30 ³ / ₄ "	12"	48"	11 ¹ / ₂ "	3	3			\$ 950	
TR-4812-A-30	Single Face Adder	29 ¹ / ₂ "	12"	48"	11 ¹ / ₂ "	3	3			\$ 763	
TR-4814-S-30	Single Face Shelving	30 ³ / ₄ "	14"	48"	14"	3	3			\$ 975	
TR-4814-A-30	Single Face Adder	29 ¹ / ₂ "	14"	48"	14"	3	3			\$ 781	
TR-4810-S-36	Single Face Shelving	37 ¹ / ₄ "	10"	48"	9 ¹ / ₂ "	3	3	55 Lbs.	__ Cu Ft	\$ 900	
TR-4810-A-36	Single Face Adder	36"	10"	48"	9 ¹ / ₂ "	3	3	47 Lbs.	__ Cu Ft	\$ 719	
TR-4812-S-36	Single Face Shelving	37 ¹ / ₄ "	12"	48"	11 ¹ / ₂ "	3	3	56 Lbs.	__ Cu Ft	\$ 919	
TR-4812-A-36	Single Face Adder	36"	12"	48"	11 ¹ / ₂ "	3	3	48 Lbs.	__ Cu Ft	\$ 725	
TR-4814-S-36	Single Face Shelving	37 ¹ / ₄ "	14"	48"	14"	3	3	59 Lbs.	__ Cu Ft	\$ 944	
TR-4814-A-36	Single Face Adder	36"	14"	48"	14"	3	3	53 Lbs.	__ Cu Ft	\$ 744	

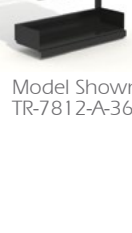
SHELVING

MODEL NUMBER	PRODUCT	WIDTH	DEPTH	HEIGHT	SHELF DEPTH	# OF SHELVES	# OF OPENINGS	WEIGHT	VOLUME	LIST PRICE	DESCRIPTION
 Model Shown TR-6612-S-36	TR-6610-S-24	Single Face Shelving	24 ³ / ₄ "	10"	66"	9 ¹ / ₂ "	4			\$ 1,106	Made of a 1-1/4" x 2" metal frame with powder coat paint. METAL FINISHING: All metal components are thoroughly cleaned and coated electrostatically with an epoxy powder coat paint finish. The metal components are then oven baked and cured for a lasting finish.
	TR-6610-A-24	Single Face Adder	23 ¹ / ₂ "	10"	66"	9 ¹ / ₂ "	4			\$ 894	
	TR-6612-S-24	Single Face Shelving	24 ³ / ₄ "	12"	66"	11 ¹ / ₂ "	4			\$ 1,131	
	TR-6612-A-24	Single Face Adder	23 ¹ / ₂ "	12"	66"	11 ¹ / ₂ "	4			\$ 919	
	TR-6614-S-24	Single Face Shelving	24 ³ / ₄ "	14"	66"	14"	4			\$ 1,156	
	TR-6614-A-24	Single Face Adder	23 ¹ / ₂ "	14"	66"	14"	4			\$ 944	
 Model Shown TR-6614-A-36	TR-6610-S-30	Single Face Shelving	30 ³ / ₄ "	10"	66"	9 ¹ / ₂ "	4			\$ 1,106	
	TR-6610-A-30	Single Face Adder	29 ¹ / ₂ "	10"	66"	9 ¹ / ₂ "	4			\$ 894	
	TR-6612-S-30	Single Face Shelving	30 ³ / ₄ "	12"	66"	11 ¹ / ₂ "	4			\$ 1,131	
	TR-6612-A-30	Single Face Adder	29 ¹ / ₂ "	12"	66"	11 ¹ / ₂ "	4			\$ 919	
	TR-6614-S-30	Single Face Shelving	30 ³ / ₄ "	14"	66"	14"	4			\$ 1,156	
	TR-6614-A-30	Single Face Adder	29 ¹ / ₂ "	14"	66"	14"	4			\$ 944	
 Model Shown TR-6614-A-36	TR-6610-S-36	Single Face Shelving	37 ¹ / ₄ "	10"	66"	9 ¹ / ₂ "	4	69 Lbs.	___ Cu Ft	\$ 1,063	
	TR-6610-A-36	Single Face Adder	36"	10"	66"	9 ¹ / ₂ "	4	57 Lbs.	___ Cu Ft	\$ 850	
	TR-6612-S-36	Single Face Shelving	37 ¹ / ₄ "	12"	66"	11 ¹ / ₂ "	4	70 Lbs.	___ Cu Ft	\$ 1,094	
	TR-6612-A-36	Single Face Adder	36"	12"	66"	11 ¹ / ₂ "	4	59 Lbs.	___ Cu Ft	\$ 869	
	TR-6614-S-36	Single Face Shelving	37 ¹ / ₄ "	14"	66"	14"	4	77 Lbs.	___ Cu Ft	\$ 1,113	
	TR-6614-A-36	Single Face Adder	36"	14"	66"	14"	4	65 Lbs.	___ Cu Ft	\$ 888	
 Model Shown TR-7812-S-36	TR-7810-S-24	Single Face Shelving	24 ³ / ₄ "	10"	78"	9 ¹ / ₂ "	5			\$ 1,281	
	TR-7810-A-24	Single Face Adder	23 ¹ / ₂ "	10"	78"	9 ¹ / ₂ "	5			\$ 1,050	
	TR-7812-S-24	Single Face Shelving	24 ³ / ₄ "	12"	78"	11 ¹ / ₂ "	5			\$ 1,313	
	TR-7812-A-24	Single Face Adder	23 ¹ / ₂ "	12"	78"	11 ¹ / ₂ "	5			\$ 1,081	
	TR-7814-S-24	Single Face Shelving	24 ³ / ₄ "	14"	78"	14"	5			\$ 1,344	
	TR-7814-A-24	Single Face Adder	23 ¹ / ₂ "	14"	78"	14"	5			\$ 1,113	
 Model Shown TR-7814-A-36	TR-7810-S-30	Single Face Shelving	30 ³ / ₄ "	10"	78"	9 ¹ / ₂ "	5			\$ 1,281	
	TR-7810-A-30	Single Face Adder	29 ¹ / ₂ "	10"	78"	9 ¹ / ₂ "	5			\$ 1,050	
	TR-7812-S-30	Single Face Shelving	30 ³ / ₄ "	12"	78"	11 ¹ / ₂ "	5			\$ 1,313	
	TR-7812-A-30	Single Face Adder	29 ¹ / ₂ "	12"	78"	11 ¹ / ₂ "	5			\$ 1,081	
	TR-7814-S-30	Single Face Shelving	30 ³ / ₄ "	14"	78"	14"	5			\$ 1,344	
	TR-7814-A-30	Single Face Adder	29 ¹ / ₂ "	14"	78"	14"	5			\$ 1,113	
 Model Shown TR-7814-A-36	TR-7810-S-36	Single Face Shelving	37 ¹ / ₄ "	10"	78"	9 ¹ / ₂ "	5	80 Lbs.	___ Cu Ft	\$ 1,231	
	TR-7810-A-36	Single Face Adder	36"	10"	78"	9 ¹ / ₂ "	5	67 Lbs.	___ Cu Ft	\$ 994	
	TR-7812-S-36	Single Face Shelving	37 ¹ / ₄ "	12"	78"	11 ¹ / ₂ "	5	83 Lbs.	___ Cu Ft	\$ 1,256	
	TR-7812-A-36	Single Face Adder	36"	12"	78"	11 ¹ / ₂ "	5	70 Lbs.	___ Cu Ft	\$ 1,019	
	TR-7814-S-36	Single Face Shelving	37 ¹ / ₄ "	14"	78"	14"	5	92 Lbs.	___ Cu Ft	\$ 1,294	
	TR-7814-A-36	Single Face Adder	36"	14"	78"	14"	5	77 Lbs.	___ Cu Ft	\$ 1,044	

SHELVING

MODEL NUMBER	PRODUCT	WIDTH	DEPTH	HEIGHT	SHELF DEPTH	# OF SHELVES	# OF OPENINGS	WEIGHT	VOLUME	LIST PRICE	DESCRIPTION
--------------	---------	-------	-------	--------	-------------	--------------	---------------	--------	--------	------------	-------------



Model Shown
TR-8412-S-36

TR-8410-S-24	Single Face Shelving	24 ³ / ₄ "	10"	84"	9 ¹ / ₂ "	6	6			\$ 1,469	Made of a 1-1/4" x 2" metal frame with powder coat paint. METAL FINISHING: All metal components are thoroughly cleaned and coated electrostatically with an epoxy powder coat paint finish. The metal components are then oven baked and cured for a lasting finish.
TR-8410-A-24	Single Face Adder	23 ¹ / ₂ "	10"	84"	9 ¹ / ₂ "	6	6			\$ 1,213	
TR-8412-S-24	Single Face Shelving	24 ³ / ₄ "	12"	84"	11 ¹ / ₂ "	6	6			\$ 1,513	
TR-8412-A-24	Single Face Adder	23 ¹ / ₂ "	12"	84"	11 ¹ / ₂ "	6	6			\$ 1,250	
TR-8414-S-24	Single Face Shelving	24 ³ / ₄ "	14"	84"	14"	6	6			\$ 1,550	
TR-8414-A-24	Single Face Adder	23 ¹ / ₂ "	14"	84"	14"	6	6			\$ 1,281	
TR-8410-S-30	Single Face Shelving	30 ³ / ₄ "	10"	84"	9 ¹ / ₂ "	6	6			\$ 1,469	
TR-8410-A-30	Single Face Adder	29 ¹ / ₂ "	10"	84"	9 ¹ / ₂ "	6	6			\$ 1,213	
TR-8412-S-30	Single Face Shelving	30 ³ / ₄ "	12"	84"	11 ¹ / ₂ "	6	6			\$ 1,513	
TR-8412-A-30	Single Face Adder	29 ¹ / ₂ "	12"	84"	11 ¹ / ₂ "	6	6			\$ 1,250	
TR-8414-S-30	Single Face Shelving	30 ³ / ₄ "	14"	84"	14"	6	6			\$ 1,550	
TR-8414-A-30	Single Face Adder	29 ¹ / ₂ "	14"	84"	14"	6	6			\$ 1,281	



Model Shown
TR-8412-A-36

TR-8410-S-36	Single Face Shelving	37 ¹ / ₄ "	10"	84"	9 ¹ / ₂ "	6	6	98 Lbs.	__ Cu Ft	\$ 1,406
TR-8410-A-36	Single Face Adder	36"	10"	84"	9 ¹ / ₂ "	6	6	84 Lbs.	__ Cu Ft	\$ 1,150
TR-8412-S-36	Single Face Shelving	37 ¹ / ₄ "	12"	84"	11 ¹ / ₂ "	6	6	102 Lbs.	__ Cu Ft	\$ 1,444
TR-8412-A-36	Single Face Adder	36"	12"	84"	11 ¹ / ₂ "	6	6	88 Lbs.	__ Cu Ft	\$ 1,181
TR-8414-S-36	Single Face Shelving	37 ¹ / ₄ "	14"	84"	14"	6	6	114 Lbs.	__ Cu Ft	\$ 1,481
TR-8414-A-36	Single Face Adder	36"	14"	84"	14"	6	6	99 Lbs.	__ Cu Ft	\$ 1,206



Model Shown
TR-9012-S-36



TR-9010-S-24	Single Face Shelving	24 ³ / ₄ "	10"	90"	9 ¹ / ₂ "	7	7			\$ 1,675
TR-9010-A-24	Single Face Adder	23 ¹ / ₂ "	10"	90"	9 ¹ / ₂ "	7	7			\$ 1,388
TR-9012-S-24	Single Face Shelving	24 ³ / ₄ "	12"	90"	11 ¹ / ₂ "	7	7			\$ 1,719
TR-9012-A-24	Single Face Adder	23 ¹ / ₂ "	12"	90"	11 ¹ / ₂ "	7	7			\$ 1,425
TR-9014-S-24	Single Face Shelving	24 ³ / ₄ "	14"	90"	14"	7	7			\$ 1,769
TR-9014-A-24	Single Face Adder	23 ¹ / ₂ "	14"	90"	14"	7	7			\$ 1,469
TR-9010-S-30	Single Face Shelving	30 ³ / ₄ "	10"	90"	9 ¹ / ₂ "	7	7			\$ 1,675
TR-9010-A-30	Single Face Adder	29 ¹ / ₂ "	10"	90"	9 ¹ / ₂ "	7	7			\$ 1,388
TR-9012-S-30	Single Face Shelving	30 ³ / ₄ "	12"	90"	11 ¹ / ₂ "	7	7			\$ 1,719
TR-9012-A-30	Single Face Adder	29 ¹ / ₂ "	12"	90"	11 ¹ / ₂ "	7	7			\$ 1,425
TR-9014-S-30	Single Face Shelving	30 ³ / ₄ "	14"	90"	14"	7	7			\$ 1,769
TR-9014-A-30	Single Face Adder	29 ¹ / ₂ "	14"	90"	14"	7	7			\$ 1,469



Model Shown
TR-9012-A-36

TR-9010-S-36	Single Face Shelving	37 ¹ / ₄ "	10"	90"	9 ¹ / ₂ "	7	7	103 Lbs.	__ Cu Ft	\$ 1,606
TR-9010-A-36	Single Face Adder	36"	10"	90"	9 ¹ / ₂ "	7	7	85 Lbs.	__ Cu Ft	\$ 1,313
TR-9012-S-36	Single Face Shelving	37 ¹ / ₄ "	12"	90"	11 ¹ / ₂ "	7	7	104 Lbs.	__ Cu Ft	\$ 1,650
TR-9012-A-36	Single Face Adder	36"	12"	90"	11 ¹ / ₂ "	7	7	89 Lbs.	__ Cu Ft	\$ 1,344
TR-9014-S-36	Single Face Shelving	37 ¹ / ₄ "	14"	90"	14"	7	7	116 Lbs.	__ Cu Ft	\$ 1,706
TR-9014-A-36	Single Face Adder	36"	14"	90"	14"	7	7	100 Lbs.	__ Cu Ft	\$ 1,388

SHELVING

MODEL NUMBER	PRODUCT	WIDTH	DEPTH	HEIGHT	SHELF DEPTH	# OF SHELVES	# OF OPENINGS	WEIGHT	VOLUME	LIST PRICE	DESCRIPTION
 Model Shown TR-4224-S-36	TR-4220-S-24	Double Face Shelving	24 ³ / ₄ "	20"	42"	9 ¹ / ₂ "	6			\$ 1,394	Made of a 1-1/4" x 2" metal frame with powder coat paint. METAL FINISHING: All metal components are thoroughly cleaned and coated electrostatically with an epoxy powder coat paint finish. The metal components are then oven baked and cured for a lasting finish.
	TR-4220-A-24	Double Face Adder	23 ¹ / ₂ "	20"	42"	9 ¹ / ₂ "	6			\$ 1,175	
	TR-4224-S-24	Double Face Shelving	24 ³ / ₄ "	24"	42"	11 ¹ / ₂ "	6			\$ 1,431	
	TR-4224-A-24	Double Face Adder	23 ¹ / ₂ "	24"	42"	11 ¹ / ₂ "	6			\$ 1,206	
	TR-4228-S-24	Double Face Shelving	24 ³ / ₄ "	28"	42"	14"	6			\$ 1,469	
	TR-4228-A-24	Double Face Adder	23 ¹ / ₂ "	28"	42"	14"	6			\$ 1,244	
 Model Shown TR-4824-S-36	TR-4220-S-30	Double Face Shelving	30 ³ / ₄ "	20"	42"	9 ¹ / ₂ "	6			\$ 1,394	
	TR-4220-A-30	Double Face Adder	29 ¹ / ₂ "	20"	42"	9 ¹ / ₂ "	6			\$ 1,175	
	TR-4224-S-30	Double Face Shelving	30 ³ / ₄ "	24"	42"	11 ¹ / ₂ "	6			\$ 1,431	
	TR-4224-A-30	Double Face Adder	29 ¹ / ₂ "	24"	42"	11 ¹ / ₂ "	6			\$ 1,206	
	TR-4228-S-30	Double Face Shelving	30 ³ / ₄ "	28"	42"	14"	6			\$ 1,469	
	TR-4228-A-30	Double Face Adder	29 ¹ / ₂ "	28"	42"	14"	6			\$ 1,244	
 Model Shown TR-4824-A-36	TR-4220-S-36	Double Face Shelving	36 ³ / ₄ "	20"	42"	9 ¹ / ₂ "	6	82 Lbs.	__ Cu Ft	\$ 1,331	
	TR-4220-A-36	Double Face Adder	35 ¹ / ₂ "	20"	42"	9 ¹ / ₂ "	6	73 Lbs.	__ Cu Ft	\$ 1,113	
	TR-4224-S-36	Double Face Shelving	36 ³ / ₄ "	24"	42"	11 ¹ / ₂ "	6	86 Lbs.	__ Cu Ft	\$ 1,369	
	TR-4224-A-36	Double Face Adder	35 ¹ / ₂ "	24"	42"	11 ¹ / ₂ "	6	76 Lbs.	__ Cu Ft	\$ 1,144	
	TR-4228-S-36	Double Face Shelving	36 ³ / ₄ "	28"	42"	14"	6	96 Lbs.	__ Cu Ft	\$ 1,406	
	TR-4228-A-36	Double Face Adder	35 ¹ / ₂ "	28"	42"	14"	6	86 Lbs.	__ Cu Ft	\$ 1,175	
	TR-4820-S-24	Double Face Shelving	24 ³ / ₄ "	20"	48"	9 ¹ / ₂ "	6			\$ 1,431	
	TR-4820-A-24	Double Face Adder	23 ¹ / ₂ "	20"	48"	9 ¹ / ₂ "	6			\$ 1,206	
	TR-4824-S-24	Double Face Shelving	24 ³ / ₄ "	24"	48"	11 ¹ / ₂ "	6			\$ 1,469	
	TR-4824-A-24	Double Face Adder	23 ¹ / ₂ "	24"	48"	11 ¹ / ₂ "	6			\$ 1,244	
	TR-4828-S-24	Double Face Shelving	24 ³ / ₄ "	28"	48"	14"	6			\$ 1,513	
	TR-4828-A-24	Double Face Adder	23 ¹ / ₂ "	28"	48"	14"	6			\$ 1,281	
	TR-4820-S-30	Double Face Shelving	30 ³ / ₄ "	20"	48"	9 ¹ / ₂ "	6			\$ 1,431	
	TR-4820-A-30	Double Face Adder	29 ¹ / ₂ "	20"	48"	9 ¹ / ₂ "	6			\$ 1,206	
	TR-4824-S-30	Double Face Shelving	30 ³ / ₄ "	24"	48"	11 ¹ / ₂ "	6			\$ 1,469	
	TR-4824-A-30	Double Face Adder	29 ¹ / ₂ "	24"	48"	11 ¹ / ₂ "	6			\$ 1,244	
	TR-4828-S-30	Double Face Shelving	30 ³ / ₄ "	28"	48"	14"	6			\$ 1,513	
	TR-4828-A-30	Double Face Adder	29 ¹ / ₂ "	28"	48"	14"	6			\$ 1,281	
	TR-4820-S-36	Double Face Shelving	37 ¹ / ₄ "	20"	48"	9 ¹ / ₂ "	6	84 Lbs.	__ Cu Ft	\$ 1,369	
	TR-4820-A-36	Double Face Adder	36"	20"	48"	9 ¹ / ₂ "	6	75 Lbs.	__ Cu Ft	\$ 1,144	
	TR-4824-S-36	Double Face Shelving	37 ¹ / ₄ "	24"	48"	11 ¹ / ₂ "	6	88 Lbs.	__ Cu Ft	\$ 1,406	
	TR-4824-A-36	Double Face Adder	36"	24"	48"	11 ¹ / ₂ "	6	78 Lbs.	__ Cu Ft	\$ 1,181	
	TR-4828-S-36	Double Face Shelving	37 ¹ / ₄ "	28"	48"	14"	6	98 Lbs.	__ Cu Ft	\$ 1,450	
	TR-4828-A-36	Double Face Adder	36"	28"	48"	14"	6	88 Lbs.	__ Cu Ft	\$ 1,206	

MODEL NUMBER	PRODUCT	WIDTH	DEPTH	HEIGHT	SHELF DEPTH	# OF SHELVES	# OF OPENINGS	WEIGHT	VOLUME	LIST PRICE	DESCRIPTION
TR-4212-S-M-24	Single Face Shelving	25 1/4"	12"	42"	11 1/2"	2	2	65 Lbs.	__ Cu Ft	\$ 1,113	Made of a 1-1/4" x 2" metal frame with powder coat paint. METAL FINISHING: All metal components are thoroughly cleaned and coated electrostatically with an epoxy powder coat paint finish. The metal components are then oven baked and cured for a lasting finish.
TR-4212-A-M-24	Single Face Adder	24"	12"	42"	11 1/2"	2	2	57 Lbs.	__ Cu Ft	\$ 913	
TR-4212-S-M-30	Single Face Shelving	31 1/4"	12"	42"	11 1/2"	2	2			\$ 1,113	
TR-4212-A-M-30	Single Face Adder	30"	12"	42"	11 1/2"	2	2			\$ 913	
TR-4212-S-M-36	Single Face Shelving	37 1/4"	12"	42"	11 1/2"	2	2			\$ 1,025	
TR-4212-A-M-36	Single Face Adder	36"	12"	42"	11 1/2"	2	2			\$ 831	
TR-4812-S-M-24	Single Face Shelving	25 1/4"	12"	48"	11 1/2"	3	3	67 Lbs.	__ Cu Ft	\$ 1,406	
TR-4812-A-M-24	Single Face Adder	24"	12"	48"	11 1/2"	3	3	59 Lbs.	__ Cu Ft	\$ 1,206	
TR-4812-S-M-30	Single Face Shelving	31 1/4"	12"	48"	11 1/2"	3	3			\$ 1,406	
TR-4812-A-M-30	Single Face Adder	30"	12"	48"	11 1/2"	3	3			\$ 1,206	
TR-4812-S-M-36	Single Face Shelving	37 1/4"	12"	48"	11 1/2"	3	3			\$ 1,306	
TR-4812-A-M-36	Single Face Adder	36"	12"	48"	11 1/2"	3	3			\$ 1,113	
TR-6612-S-M-24	Single Face Shelving	25 1/4"	12"	66"	11 1/2"	4	4	107 Lbs.	__ Cu Ft	\$ 1,725	
TR-6612-A-M-24	Single Face Adder	24"	12"	66"	11 1/2"	4	4	95 Lbs.	__ Cu Ft	\$ 1,500	
TR-6612-S-M-30	Single Face Shelving	31 1/4"	12"	66"	11 1/2"	4	4			\$ 1,725	
TR-6612-A-M-30	Single Face Adder	30"	12"	66"	11 1/2"	4	4			\$ 1,500	
TR-6612-S-M-36	Single Face Shelving	37 1/4"	12"	66"	11 1/2"	4	4			\$ 1,606	
TR-6612-A-M-36	Single Face Adder	36"	12"	66"	11 1/2"	4	4			\$ 1,381	
TR-7812-S-M-24	Single Face Shelving	25 1/4"	12"	78"	11 1/2"	5	5	129 Lbs.	__ Cu Ft	\$ 2,050	
TR-7812-A-M-24	Single Face Adder	24"	12"	78"	11 1/2"	5	5	115 Lbs.	__ Cu Ft	\$ 1,806	
TR-7812-S-M-30	Single Face Shelving	31 1/4"	12"	78"	11 1/2"	5	5			\$ 2,050	
TR-7812-A-M-30	Single Face Adder	30"	12"	78"	11 1/2"	5	5			\$ 1,806	
TR-7812-S-M-36	Single Face Shelving	37 1/4"	12"	78"	11 1/2"	5	5			\$ 1,900	
TR-7812-A-M-36	Single Face Adder	36"	12"	78"	11 1/2"	5	5			\$ 1,663	
TR-9012-S-M-24	Single Face Shelving	25 1/4"	12"	90"	11 1/2"	6	6	148 Lbs.	__ Cu Ft	\$ 2,606	
TR-9012-A-M-24	Single Face Adder	24"	12"	90"	11 1/2"	6	6	132 Lbs.	__ Cu Ft	\$ 2,306	
TR-9012-S-M-30	Single Face Shelving	31 1/4"	12"	90"	11 1/2"	6	6			\$ 2,606	
TR-9012-A-M-30	Single Face Adder	30"	12"	90"	11 1/2"	6	6			\$ 2,306	
TR-9012-S-M-36	Single Face Shelving	37 1/4"	12"	90"	11 1/2"	6	6			\$ 2,419	
TR-9012-A-M-36	Single Face Adder	36"	12"	90"	11 1/2"	6	6			\$ 2,119	



Model Shown
TR-4812-S-M-36



Model Shown
TR-6612-S-M-36



Model Shown
TR-7812-S-M-36



Model Shown
TR-9012-S-M-36

SHELVING

MODEL NUMBER	PRODUCT	WIDTH	DEPTH	HEIGHT	SHELF DEPTH	# OF SHELVES	# OF OPENINGS	WEIGHT	VOLUME	LIST PRICE	DESCRIPTION
TR-4224-S-M-24	Double Face Shelving	25 1/4"	24"	42"	11 1/2"	4	4	104 Lbs.	__ Cu Ft	\$ 1,769	Made of a 1-1/4" x 2" metal frame with powder coat paint. METAL FINISHING: All metal components are thoroughly cleaned and coated electrostatically with an epoxy powder coat paint finish. The metal components are then oven baked and cured for a lasting finish.
TR-4224-A-M-24	Double Face Adder	24"	24"	42"	11 1/2"	4	4	94 Lbs.	__ Cu Ft	\$ 1,544	
TR-4224-S-M-30	Double Face Shelving	31 1/4"	24"	42"	11 1/2"	4	4			\$ 1,769	
TR-4224-A-M-30	Double Face Adder	30"	24"	42"	11 1/2"	4	4			\$ 1,544	
TR-4224-S-M-36	Double Face Shelving	37 1/4"	24"	42"	11 1/2"	4	4			\$ 1,625	
TR-4224-A-M-36	Double Face Adder	36"	24"	42"	11 1/2"	4	4			\$ 1,400	
TR-4824-S-M-24	Double Face Shelving	25 1/4"	24"	48"	11 1/2"	6	6	106 Lbs.	__ Cu Ft	\$ 2,350	
TR-4824-A-M-24	Double Face Adder	24"	24"	48"	11 1/2"	6	6	96 Lbs.	__ Cu Ft	\$ 2,113	
TR-4824-S-M-30	Double Face Shelving	31 1/4"	24"	48"	11 1/2"	6	6			\$ 2,350	
TR-4824-A-M-30	Double Face Adder	30"	24"	48"	11 1/2"	6	6			\$ 2,113	
TR-4824-S-M-36	Double Face Shelving	37 1/4"	24"	48"	11 1/2"	6	6			\$ 2,181	
TR-4824-A-M-36	Double Face Adder	36"	24"	48"	11 1/2"	6	6			\$ 1,950	
TR-6624-S-M-24	Double Face Shelving	25 1/4"	24"	66"	11 1/2"	8	8	182 Lbs.	__ Cu Ft	\$ 2,938	
TR-6624-A-M-24	Double Face Adder	24"	24"	66"	11 1/2"	8	8	167 Lbs.	__ Cu Ft	\$ 2,669	
TR-6624-S-M-30	Double Face Shelving	31 1/4"	24"	66"	11 1/2"	8	8			\$ 2,938	
TR-6624-A-M-30	Double Face Adder	30"	24"	66"	11 1/2"	8	8			\$ 2,669	
TR-6624-S-M-36	Double Face Shelving	37 1/4"	24"	66"	11 1/2"	8	8			\$ 2,719	
TR-6624-A-M-36	Double Face Adder	36"	24"	66"	11 1/2"	8	8			\$ 2,463	
TR-7824-S-M-24	Double Face Shelving	25 1/4"	24"	78"	11 1/2"	10	10	218 Lbs.	__ Cu Ft	\$ 4,313	
TR-7824-A-M-24	Double Face Adder	24"	24"	78"	11 1/2"	10	10	202 Lbs.	__ Cu Ft	\$ 3,275	
TR-7824-S-M-30	Double Face Shelving	31 1/4"	24"	78"	11 1/2"	10	10			\$ 4,313	
TR-7824-A-M-30	Double Face Adder	30"	24"	78"	11 1/2"	10	10			\$ 3,275	
TR-7824-S-M-36	Double Face Shelving	37 1/4"	24"	78"	11 1/2"	10	10			\$ 3,306	
TR-7824-A-M-36	Double Face Adder	36"	24"	78"	11 1/2"	10	10			\$ 3,025	
TR-9024-S-M-24	Double Face Shelving	25 1/4"	24"	90"	11 1/2"	12	12	255 Lbs.	__ Cu Ft	\$ 4,569	
TR-9024-A-M-24	Double Face Adder	24"	24"	90"	11 1/2"	12	12	237 Lbs.	__ Cu Ft	\$ 4,200	
TR-9024-S-M-30	Double Face Shelving	31 1/4"	24"	90"	11 1/2"	12	12			\$ 4,569	
TR-9024-A-M-30	Double Face Adder	30"	24"	90"	11 1/2"	12	12			\$ 4,200	
TR-9024-S-M-36	Double Face Shelving	37 1/4"	24"	90"	11 1/2"	12	12			\$ 4,219	
TR-9024-A-M-36	Double Face Adder	36"	24"	90"	11 1/2"	12	12			\$ 3,875	



Model Shown
TR-4824-S-M-36





Model Shown
TR-6624-S-M-36







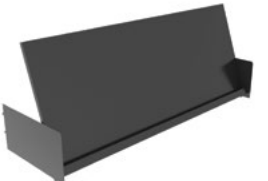

Model Shown
TR-7824-S-M-36





Model Shown
TR-9024-S-M-36

	MODEL NUMBER	PRODUCT	WIDTH	DEPTH	HEIGHT	WEIGHT	VOLUME	LIST PRICE	DESCRIPTION
 Model Shown TR-SL12-36	TR-SL10-24	Slotted Metal Shelf	23 1/4"	5"	9 1/2"			\$ 250	Divider shelf is 5" high with 3 metal dividers. Shelf is slotted at 2" intervals.
	TR-SL12-24		23 1/4"	5"	11 1/2"			\$ 263	
	TR-SL10-30		29 1/4"	5"	9 1/2"			\$ 250	
	TR-SL12-30		29 1/4"	5"	11 1/2"			\$ 263	
	TR-SL10-36		35 1/4"	5"	9 1/2"			\$ 244	
	TR-SL12-36		35 1/4"	5"	11 1/2"			\$ 250	
 Model Shown TR-LB12-36	TR-LB10-24	Low Back Metal Shelf	23 1/4"	6"	9 1/2"			\$ 144	Metal shelf with a 1 1/4" high book stop back edge.
	TR-LB12-24		23 1/4"	6"	11 1/2"			\$ 150	
	TR-LB14-24		23 1/4"	6"	14"			\$ 156	
	TR-LB10-30		29 1/4"	6"	9 1/2"			\$ 144	
	TR-LB12-30		29 1/4"	6"	11 1/2"			\$ 150	
	TR-LB14-30		29 1/4"	6"	14"			\$ 156	
 Model Shown TR-F12-36	TR-F10-24	Flat Metal Shelf	23 1/4"	6"	9 1/2"			\$ 138	Metal shelf with no book stop back edge.
	TR-F12-24		23 1/4"	6"	11 1/2"			\$ 144	
	TR-F14-24		23 1/4"	6"	14"			\$ 144	
	TR-F10-30		29 1/4"	6"	9 1/2"			\$ 138	
	TR-F12-30		29 1/4"	6"	11 1/2"			\$ 144	
	TR-F14-30		29 1/4"	6"	14"			\$ 144	
 Model Shown TR-M12-36	TR-M12-24	Hinged Magazine Shelf	23 1/4"		12"			\$ 138	Hinged metal magazine shelf with 12" height and 1" deep x 3/4" high lip.
	TR-M12-30		29 1/4"		12"			\$ 138	
	TR-M12-36		35 1/4"		12"			\$ 131	

	MODEL NUMBER	PRODUCT	WIDTH	DEPTH	HEIGHT	WEIGHT	VOLUME	LIST PRICE	DESCRIPTION
 <p>Model Shown TR-MSL10-36</p>	TR-MSL10-24	Media Shelf: Sloped	23 1/4"		8"			\$ 75	Metal sloped media shelf with 8" height.
	TR-MSL10-30		29 1/4"		8"			\$ 81	
	TR-MSL10-36		35 1/4"		8"			\$ 81	
 <p>Model Shown TR-ZZ12-36</p>	TR-ZZ12-24	Media Shelf: Zig Zag Display	23 1/4"		6"			\$ 31	Metal multi-media display or storage for compact discs, video tapes or paper back books.
	TR-ZZ12-30		29 1/4"		6"			\$ 31	
	TR-ZZ12-36		35 1/4"		6"			\$ 31	
 <p>Model Shown TR-ME12-36</p>	TR-ME12-24	Metal Media Shelf	23 1/4"	4 3/4"	12"	15 Lbs.	1 Cu Ft	\$ 75	18 gauge cold rolled steel with flanges. Front of shelf bent to 90 degrees, 4" high above the shelf. Back flange forms a triple bend End flanges notched to accept 1/16" galvanized shelf support pin. "
	TR-ME12-30		29 1/4"	4 3/4"	12"			\$ 81	
	TR-ME12-36		35 1/4"	4 3/4"	12"			\$ 81	
 <p>Model Shown TR-ND-VT</p>	TR-ND-AC	Media Shelf - New Display			5 3/4"			\$ 31	Metal media shelf displays audio cassettes, compact discs and video tapes. Display is installed front face towards patrons in upright position.
	TR-ND-CD				5 3/4"			\$ 31	
	TR-ND-VT				9"			\$ 44	
 <p>Model Shown TR-H35</p>	TR-H24	Media Shelf - Hanging Bag Rod						\$ 56	Two 3/8" diameter metal rods for media bag storage materials.
	TR-H30							\$ 56	
	TR-H35							\$ 56	

	MODEL NUMBER	PRODUCT	WIDTH	DEPTH	HEIGHT	WEIGHT	VOLUME	LIST PRICE	DESCRIPTION
	TR-M-GSB	Bottom Metal Grooved Shelf Option						\$ 44	Grooved Metal shelf to accept pendant dividers upcharge. Notes: Each Shelf comes with one Pendant Divider. Additional Pendants can be ordered separately.
	PD-01	Wire Pendant Divider						\$ 19	Wire Pendant Divider, chrome finish.
	TR-SL-D10	Divider	9 1/2"		5"			\$ 13	Metal Dividers for divider shelf are 5" high and come in depths of 9 1/2" and 11 1/2".
	TR-SL-D12		11 1/2"		5"			\$ 19	
 Model Shown TR-SL-D12	WBS-01	Wire Book Support - For Low Back Shelf						\$ 25	Chrome Clip-on wire book support for low back shelves.
 Model Shown TR-BE6	M-BE6	Metal Book End						\$ 19	Metal book end stop with rubber bottoms.
	M-BE9							\$ 25	
	TR-MS3624	Mobile Frame, (Up to 60" H Units)	36"	24"				\$ 456	Not recommended for units higher than 60"

	MODEL NUMBER	PRODUCT	WIDTH	DEPTH	HEIGHT	WEIGHT	VOLUME	LIST PRICE	DESCRIPTION
 <p>Model Shown TR-JB36</p>	TR-JB24	24" Junction Bar	24"	1 1/8"	5"			\$ 63	Steel junction bars are 1 1/8" x 5" and connect to right and left upright columns. Comes in widths of 24", 30" and 36".
	TR-JB30	30" Junction Bar	30"	1 1/8"	5"			\$ 63	
	TR-JB36	36" Junction Bar	36"	1 1/8"	5"			\$ 63	
 <p>Model Shown TR-KP36</p>	TR-KP24	24" Kickplate	24"		2"			\$ 31	Metal 2" high kickplate installs with two drop-in pins and comes in sizes of 24", 30", and 36" wide.
	TR-KP30	30" Kickplate	30"		2"			\$ 31	
	TR-KP36	36" Kickplate	36"		2"			\$ 25	
 <p>Model Shown TR-CT-BKT-SF</p>	TR-CT-BKT-SF	Single Face Canopy Top Bracket	9 1/2"		5"			\$ 50	One pair of metal brackets for wood canopy tops. Universal size for all depth shelving units. Available in single and double faced applications
	TR-CT-BKT-DF	Double Face Canopy Top Bracket	11 1/2"		5"			\$ 100	
 <p>Model Shown TR-EP-BKT</p>	TR-EP-BKT	Single Face End Panel Bracket Units Below 60" Height						\$ 25	Side and base mounting for finished wood end panels. Available in single and double faced applications.
	TR-EP-BKT-60	Single Face End Panel Bracket Units 60" Height and Above						\$ 44	
 <p>Model Shown TR-EXT-12-SF</p>	TR-EXT12-SF	Single Face Upright Column Extender						\$ ____	Made of 1 1/4" x 2" powder coat painted metal tube. Application extends existing unit height to 12".
	TR-EXT12-DF	Double Face Upright Column Extender						\$ ____	

	MODEL NUMBER	PRODUCT	WIDTH	DEPTH	HEIGHT	WEIGHT	VOLUME	LIST PRICE	DESCRIPTION
 <p>Model Shown TR-UC-7212</p>	TR-UC-4210	Single Face Upright Column						\$ 181	Made of a 1 1/4" x 2" metal frame with powder coat paint. Contains adjustable levelers. Metal Shelves adjust by 1" increments.
	TR-UC-4810		\$ 188						
	TR-UC-6610		\$ 206						
	TR-UC-7210		\$ 225						
	TR-UC-8410		\$ 250						
	TR-UC-9010		\$ 281						
	TR-UC-4212	\$ 181	METAL FINISHING: All metal components are thoroughly cleaned and coated electrostatically with an epoxy powder coat paint finish. The metal components are then oven baked and cured for a lasting finish.						
	TR-UC-4812	\$ 194							
	TR-UC-6612	\$ 213							
	TR-UC-7212	\$ 231							
	TR-UC-8412	\$ 256							
	TR-UC-9012	\$ 288							
	TR-UC-4214	\$ 194							
	TR-UC-4814	\$ 200							
TR-UC-6614	\$ 219								
TR-UC-7214	\$ 238								
TR-UC-8414	\$ 269								
TR-UC-9014	\$ 300								
 <p>Model Shown TR-UC-7224</p>	TR-UC-4220	Double Face Upright Column						\$ 213	Made of a 1 1/4" x 2" metal frame with powder coat paint. Contains adjustable levelers. Metal Shelves adjust by 1" increments.
	TR-UC-4820		\$ 219						
	TR-UC-6620		\$ 238						
	TR-UC-7220		\$ 275						
	TR-UC-8420		\$ 300						
	TR-UC-9020		\$ 331						
	TR-UC-4224	\$ 219	METAL FINISHING: All metal components are thoroughly cleaned and coated electrostatically with an epoxy powder coat paint finish. The metal components are then oven baked and cured for a lasting finish.						
	TR-UC-4824	\$ 225							
	TR-UC-6624	\$ 250							
	TR-UC-7224	\$ 281							
	TR-UC-8424	\$ 306							
	TR-UC-9024	\$ 338							
	TR-UC-4228	\$ 231							
	TR-UC-4828	\$ 238							
TR-UC-6628	\$ 263								
TR-UC-7228	\$ 300								
TR-UC-8428	\$ 319								
TR-UC-9028	\$ 356								

Palmieri Furniture Limited ("Palmieri") warrants that its products and collections are free from defects in materials and workmanship for the life of the product, except as set forth below. Palmieri Limited Lifetime Warranty is valid from the date of delivery.

Exceptions to the Limited Lifetime Warranty: Seating: two (2) years

Goods sold hereunder are covered by a Limited Lifetime Warranty, free against defects in material and workmanship provided the goods and services are subjected to normal use and service. The applicable warranty period commences from shipping date to Purchaser of any item of the goods, whichever occurs first, or any other warranty period otherwise stipulated in writing by Palmieri under this sale. For components not supplied by Palmieri, the original manufacturer's warranty shall apply to the extent assignable by Palmieri. The obligation under this warranty is limited to the repair or replacement, at Palmieri's option, of defective parts F.O.B. point of shipment provided that prompt notice of any defect is given by Purchaser to Palmieri in writing within the applicable warranty period and that upon the Purchaser's return of the defective parts to Palmieri or, if designated by Palmieri, to the location where the works are made, properly packed and with transportation charges prepaid by Purchaser, an inspection thereof shall reveal to Palmieri's satisfaction that Purchaser's claim is valid under the terms of this warranty. Purchaser shall assume all responsibility and expense for dismantling, removal, re-installation and freight in connection with the foregoing. The same obligations and conditions extend to replacement parts furnished by Palmieri hereunder.

Palmieri does not assume liability for installation, labour or consequential damages. Palmieri makes no warranty other than the one set forth herein. All other warranties, legal, expressed or implied, including but not limited to any expressed or implied warranty of merchantability, of fitness for the intended use thereof or against infringement are hereby expressly excluded. The applicable warranty ceases to be effective if the goods are altered or repaired other than by persons authorized or approved by Palmieri to perform such work. Repairs or replacement deliveries do not interrupt or prolong the term of the warranty. The warranty ceases to be effective if Purchaser fails to handle and use the goods sold hereunder in a safe and reasonable manner and in accordance with any written instructions from the manufacturers.

Warranty Does Not Apply To Product Failure Or Loss Resulting From:

Abuse, misuse or accident, alteration or modification of product by customer or third party, normal wear and tear, improper installation, handling or incorrect use. The substitution of part components or hardware not approved or authorized by Palmieri, acts of God, unauthorized repairs, improper storage, and environmental conditions such as irregular temperature control either inside or outside the environment.

Warranty Provides Exclusive Remedies:

If a product fails under ordinary use as a result of a defect in material or workmanship, Palmieri will: (A) repair, or (B) replace the furniture. The replacement or repair of the Furniture or Seating will be at the discretion of Palmieri. If the defect or workmanship cannot be remedied on site, repairs can be made at the factory. (C) If the product repair or replacement is not commercially practicable or cannot be remade in a timely manner Palmieri will refund the purchase price of the affected product. A product "**Defect**" means: an inadequacy in the materials or workmanship of the product that (A) existed at the time when you received the product from Palmieri or Palmieri authorized Reseller and (B) causes a failure of the product to perform under ordinary use in accordance with the materials and documentation accompanying the product. "**Ordinary Use**" means: use of the product (A) in accordance with all applicable local, state or federal laws, codes and regulations and (B) in accordance with manufacturer recommendations and or instructions in the materials and documentation accompanying the product or through shop drawings. A "**Palmieri Authorized Reseller**" means: any dealer that is legally permitted to conduct business in the jurisdiction where the product is sold and is duly authorized by Palmieri to sell the product.

Warranty work must be approved by authorized personnel of Palmieri Furniture Limited in Richmond Hill, Ontario, Canada.

A copy of the original purchase order must accompany all claims.

Warranty Does Not Cover:

Matching of colours, stains, textures, grains and any other variations in materials. Select and Custom Surfaces and materials are only warranted for their application on the specified product and are not covered by our warranty, except as warranted by the original supplier, for quality, colorfastness, shade variations or abrasion and textiles purchased for Palmieri product.

This limited warranty is the sole remedy for product defect and no other express or implied warranty is provided. Warranty is not transferable and valid only for the original purchaser acquiring a product from Palmieri or a Palmieri authorized reseller for the purchaser's own use and not for resale, remarketing or distribution. Limited Lifetime Warranty (25 years)

GENERAL

The following Terms and Conditions of Quote and Sale shall apply to any sale of goods and services by Palmieri Furniture Limited (hereinafter called "Palmieri"). Purchaser shall be deemed to have full knowledge of the terms and conditions herein and such terms and conditions shall be binding if either the goods and services referred to herein are delivered to and accepted by Purchaser, or if Purchaser does not within five (5) days from the date hereof deliver to Palmieri written objection to said terms and conditions or any part thereof.

In the event of any conflict or inconsistency between the terms and conditions of sale herein and the terms and conditions contained in Purchaser's order or in any other form issued by Purchaser, whether or not any such form has been acknowledged or accepted by Palmieri, Palmieri's terms and conditions herein shall prevail. No waiver, alteration or modification of these terms and conditions shall be binding upon Palmieri unless made in writing and signed by a duly authorized representative of Palmieri.

1. QUOTATIONS / PRODUCT QUOTED

Unless otherwise stated, **Palmieri's quotations shall be null and void unless accepted by Purchaser within thirty (30) days from the date of quotation.** Quotes may be subject to change before order placement, due to increased material costs and or other factors that could impact the final cost of production and our final understanding of the product required. If the items quoted do not reflect the intended product requirements of the customer, Palmieri will not be held responsible for increased costs for those product changes. We reserve the right to edit or re-quote any portion of a previously submitted quotation subject to our final understanding of the product required by the client.

2. PALMIERI DRAWINGS

Palmieri provides drawings for Custom & Standard product we produce to our clients upon request. We consider these drawings to be Private and Confidential and are provided for the sole purpose and use of our clients to understand the product we are providing. The use of these confidential materials is limited to the transaction between the parties and at no point are these confidential materials to be sent to any of our competitors or parties quoting for the same purpose.

A minimum \$85.00 NET Engineering Administrative Fee will apply for Custom Product Drawings

(Note: The first set of Custom product drawings will be free of charge)

A minimum \$120.00 NET Engineering Administrative Fee will apply for all Standard Product Drawings

3. TERMS OF PAYMENT

For authorized customers; Orders at a \$75,000.00 threshold will require a mandatory 25% deposit. Orders over and above \$100,000.00 requires a mandatory (25%) deposit at time of order, a mandatory (25%) deposit prior to product shipment and the balance to be paid within thirty (30) days of date of shipment. Payment not be made to Palmieri when due, Palmieri reserves the right to charge Purchaser with interest on such overdue payments. Interest of 2% per month (24% per annum) is charged on all overdue accounts, unless otherwise specified. The charging of such interest shall not be construed as obligating Palmieri to grant any extension of time in the terms of payment. All goods remain the property of Palmieri, until balance is paid in full to Palmieri.

4. TITLE

Title to the goods or any part thereof shall not pass from Palmieri to Purchaser until all payments due hereunder have been duly made, except as otherwise expressly stipulated herein. The goods shall be and remain personal or moveable property, notwithstanding their mode of attachment to realty or other property. If default is made in any of the payments herein, Purchaser agrees that Palmieri may retain all payments which have been made on account of the purchase price as liquidated damages, and Palmieri shall be free to enter the premises where the goods may be located and remove them as Palmieri's property, without prejudice to Palmieri's right to recover any further expenses or damages Palmieri may suffer by reason of such nonpayment.

5. TAXES

Prices do not include Goods & Services Tax, Provincial or Municipal sales, use, value-added or similar tax. All applicable taxes are extra. Our Harmonized Sales Tax (HST) registration number is R104055066.

6. THE AGREEMENT

An acceptance and official confirmation of Purchasers' order by signing Palmieri's Order Confirmation the Purchaser therefore is accepting terms and conditions as expressed herein Palmieri's Terms and Conditions of Quote and Sale by Palmieri and shall constitute the complete agreement, subject to the terms and conditions of sale herein set forth, and shall supersede all previous quotations, orders or agreements.

7. LEAD TIME / DELIVERY / DELAYS

Lead time is determined only when final material/finish selection and drawing approvals are received by Palmieri from the client. The accuracy of Palmieri's lead times, is created to the best of our ability with the information provided to us. Confirmed lead time is conveyed to the client by means of Order Confirmation. They do not preclude the client from checking the accuracy of your requirement and our Order Confirmation. Any noted discrepancies are to be reported immediately to Palmieri Customer Service Department for correction and re-issue of revised Order Confirmation. By signing and dating the Order Confirmation the client accepts the terms and conditions of quote and sale.

Lead time on our Order Confirmation do not account for delays that could potentially occur for special materials specified by the client that are outside of our standard finishes and materials program that are out of our control

and will affect the lead time on the order. Palmieri will notify the client immediately when these delays occur and adjust the lead time accordingly.

Delivery schedules are approximate and are based on prevailing market conditions applicable respectively at the time of Palmieri's quotation and Palmieri's acceptance of clients' order, if certain portions of an order are completed by the quoted lead time while other portions have experienced delays outside of our control. The client may choose to part ship the order at their discretion and expense. Otherwise the entire order will ship with the delayed portion at a later date. Palmieri may extend delivery schedules or may, at its option, cancel Purchaser's order in full or in part without liability other than to return any deposit or prepayment which is unearned by reason of the cancellation.

8. CHANGES AND CANCELLATION

Orders accepted by Palmieri are not subject to changes or cancellation by Purchaser without the written consent of Palmieri. In such cases where Palmieri authorizes changes or cancellation, Palmieri reserves the right to charge the Purchaser with reasonable costs based upon expenses already incurred and commitments made by Palmieri, including, without limitation, any labour done, material purchased and also including Supplier's usual overhead and reasonable profit and cancellation charges from Palmieri's suppliers. Palmieri will communicate to the Purchaser additional costs incurred by way of Revised Order Confirmation. Revised Order Confirmation will include applicable costs incurred and modification to lead times (if applicable). The Purchaser must provide Palmieri written confirmation of additional costs, before any changes can be processed on the order.

A minimum charge of \$100.00 NET Change Order Request fee will apply

A minimum charge of \$150.00 NET Cancel Order Request fee will apply.

9. SHIPPING LOCATION / SHIPPING QUOTES / COST OF TRANSPORTATION

Unless otherwise stated, all prices are F.O.B. our factory in Richmond Hill, Ontario, Canada.

Customary methods of transportation shall be selected by Palmieri and such transportation will be at Purchaser's expense. Shipping quotations are made at time of furniture quotation and are outside the control of Palmieri. **Shipping quotes are valid for ten (10) business days from the time of quote.** We do our best to maintain shipping costs as quoted, however all shipping weights and cubic feet shown are approximate only, various construction materials and packaging methods may add to the weights given. All quoted prices, unless otherwise stated on the quotation, are based on the current exchange rates, tariffs, fuel surcharges and costs of manufacture and are subject to change by Palmieri with or without notice until Purchaser's acceptance. Palmieri does not assume responsibility or liability for shipping costs, product during transit, or variances from the shipping weights or cubic feet shown in our specification guides. Special methods of transportation will be used upon Purchaser's request and at Purchaser's additional expense, provided reasonable notice of Purchaser's transportation requirements are given by Purchaser to Palmieri prior to shipment. Palmieri will notify the client prior to shipping product if shipping costs as quoted change, at which point the client must approve the adjusted shipping costs.

10. RECEIVING PRODUCT / REPORTING DAMAGE / STORAGE OF PRODUCT

Upon receipt of Palmieri product, the receiver of the goods must immediately inspect the product to ensure it is free of shipping damage. If the product is deemed in good order, the receiver of the product must ensure

to sign off on the accompanying carriers Bill of lading in good condition. Except for obligations stated under "Warranty" herein, Palmieri's responsibility for the product ceases once the product has been received and signed off in good order and is the full responsibility of the receiver and subsequently the owner.

In the event shipping damage is discovered during receipt of shipment, it is the responsibility of the receiver to ensure all noted damage is recorded on the carrier's Bill of Lading prior to sign off. All noted shipping damage claims must be reported to Palmieri within **24 hours** of receipt of the product onsite, failure to do so will result in the claim being deemed null and void. All shipping damage claims are to be reported directly to Palmieri's Shipping Manager. Please call our toll free number at **1-800-413-4440 ext. 33** or submit the claim by Fax directly to **1-905-731-9878**. Palmieri will not accept any shipping damage claims submitted **after 24 hours** and it shall be conclusively presumed that the goods were delivered in good condition.

Storage of product, Palmieri will not be held responsible for any potential damages or shortages for product shipped and received by Purchaser and is subsequently placed into storage and not inspected within 24 hours of receipt.

11. INSTALLATION / SHORTAGES / BACK CHARGES

Unless otherwise expressly stipulated, the goods shall be installed by and at the risk and expense of Purchaser.

In the event that Palmieri is requested to supervise such installation, Palmieri's responsibility shall be limited to exercising that degree of skill customary in the trade in supervising installations of the same type. Purchaser shall remain responsible for all other aspects of the work including compliance with the local regulations. It is the responsibility of the Purchaser to ensure hardware and parts are received in good order. Packing slip and hardware list to be provided by Palmieri with every order at time of shipping. Purchaser has the responsibility to notify Palmieri immediately without delay of issues that arise; subsequently Palmieri will take action to provide prompt resolution.

Shortages must be reported to Palmieri within **24 hours** of receipt of the goods and failure to do so may be at the expense of the Purchaser.

If deemed missing hardware and parts short shipped from the factory, Palmieri will arrange to ship freight prepaid to destination. Palmieri will only be responsible for replacement costs of missing hardware and parts, any labour costs incurred will be the responsibility of the Purchaser and will not be approved by Palmieri.

Back Charges will only be approved if we deemed a defect in the material or workmanship is found during the installation period resulting in a return trip to the job-site to complete installation. It shall remain the sole discretion of Palmieri to approve (A) repair or (B) replace the furniture and any labour costs incurred by the Purchaser.

12. FORCE MAJEURE

Palmieri shall not be responsible or liable for any loss or damage incurred by Purchaser herein resulting from causes beyond the reasonable control of Palmieri including, but without limitation, abuse, misuse or accident, alteration or modification of product by customer or third party, normal wear and tear, improper installation, handling or incorrect use, unauthorized repairs, the substitution of part components or hardware not approved or authorized by Palmieri, improper storage, and environmental conditions such as irregular temperature control

either inside or outside the environment, acts of God, fire, flood, delays in transportation, or the failure of Palmieri's suppliers to meet their delivery promises. The acceptance of delivery of the goods by Purchaser shall constitute a waiver of all claims for loss or damage due to any delay whatsoever.

13. RETURNED GOODS

No goods may be returned to Palmieri for a credit or exchanged without Palmieri's prior written consent.

Palmieri reserves the right to accept all returns and subject to a handling/restocking charge or to decline all returns. Even after Palmieri has authorized the return of goods for credit, Palmieri reserves the right to adjust the amount of any credit given to Purchaser on return of the goods based on the conditions of the goods on arrival in Palmieri's warehouse. Credit for returned goods will be issued to Purchaser only where such goods are returned by Purchaser and not by any subsequent owner of the goods. Goods will be considered for return only if they are in their original condition and packaging. Palmieri Goods Return Authorization Form to be issued and **must** accompany all shipments returning back to the factory. **Return freight must be prepaid by Purchaser. A minimum 20% re-stocking fee will apply.**

1230 Reid Street
Richmond Hill
Ontario Canada
L4B 1C4

T 905 731 9300
F 905 731 9878
TF 800 413 4440

info@palmierifurniture.com
www.PalmieriFurniture.com

SPECIFICATION GUIDE & PRICE LIST

2017

PALMIER

SHELVING
UNO

CATEGORY: LIBRARY FURNITURE
CONTRACT: BID #ESCNJ 17/18-16

Introduction 1

Table of Contents 2-3

Product Materials & Finishes 4-7

Uno Shelving 8-31

 Single Face Shelving 8-15

 Double Face Shelving 16-23

 Single Face Magazine Shelving 24-27

 Double Face Magazine Shelving 28-31

Components & Accessories 32-39

 Slotted Metal Shelf, Low Back Metal Shelf, Flat Metal Shelf 32-33

 Glass Shelf, Metal Media Shelf, Hinged Magazine Shelf 34-35

 Metal Grooved Shelf Options, Wire Pendant Divider, Divider, Wire Book Support, Metal Book End 36-37

 Kickplate, Metal Back Frame, Single Face Top Shelf, Double Face Top Shelf 38-39

Panels 40-43

 Single Face Panels 40-41

 Double Face Panels 42-43

Warranty 44

Terms & Conditions 45

WOODS & FINISHES:

Natural Maple

Standard

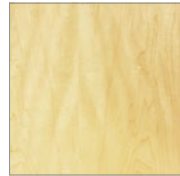

Natural Clear – M-NA

Maple Finishes

The following stains are available, add 10% to list

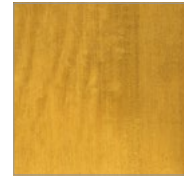

Castle Oak – M-CO

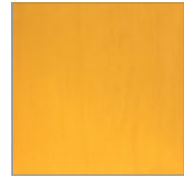

Honey Oak – M-HO

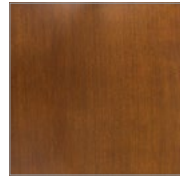

English Oak – M-EN

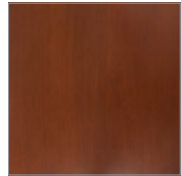

Victorian Cherry – M-VI

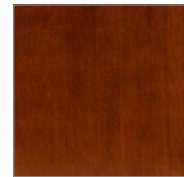

Richmond Cherry – M-RC

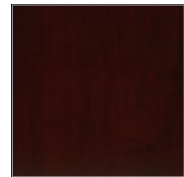

Mahogany – M-MA



Java – M-JA



Wenge – M-WE

Natural Red Oak

Standard

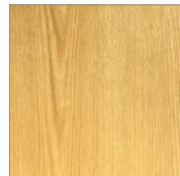

Natural Clear – O-NA

Red Oak Finishes

The following stains are available, add 10% to list

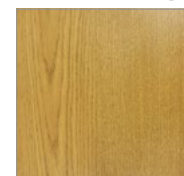

Castle Oak – O-CO

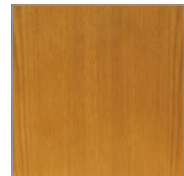

Honey Oak – O-HO

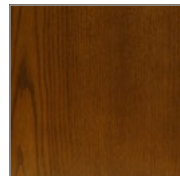

English Oak – O-EN



Victorian Cherry – O-VI



Richmond Cherry – O-RC



Mahogany – O-MA



Java – O-JA



Wenge – O-WE

Natural Cherry

Add 20% to list

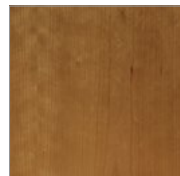

Natural Clear – C-NA

Cherry Finishes

The following stains are available, add 30% to list



Honey Oak – C-HO



Richmond Cherry – C-RC

Natural Walnut

Add 20% to list

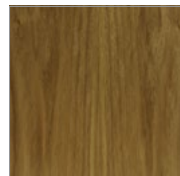

Natural Clear – W-NA

Walnut Finishes

The following stain is available, add 30% to list



Java – W-JA

HARDWOODS: All hardwood materials used in the manufacturing of Palmieri products shall be Northern grown hardwoods. Hardwoods will be air and kiln dried to a moisture content of 5-7%. All hardwoods shall be of grade "A" material, free of material stains, imperfections, conformity of grain, texture and color. Hardwood species shall be Northern grown Red Oak, Clear White Northern Maple and Birch. American Cherry and Honduras Mahogany and Walnut are available. Please inquire for pricing.

VENEER: Exposed face veneers shall be not less than 1/28" thick plain sliced veneers. Veneers are to be selected for conformity of grain direction and color. Veneers are to be stitched tightly in a book match, slip match or plain sliced configuration. Unexposed veneers are to be of hardwood but not selected for color, or grain quality. Veneers are not to be lap joined or reveal any tape or glue lines.

PARTICLE BOARD CORE: The particleboard shall be formed of wood chips, bonded with a water resistance adhesive. The particleboard material is to be of a high density 45 lbs/cu. ft. having a minimum average modulus of rupture of 2400 psi and a minimum average modulus of elasticity of 4,000,000 psi.

VENEER CORE: Veneer core is to be constructed with odd numbers of plies. Each ply is to be laminated in pairs and cross banded in opposite directions with grain direction at a 90 degree angle to the grain of the center core. All plies are to be free from knots, wrinkles, laps or other natural or manufacturing defects.

LUMBER CORE: Lumber core is to be of the highest quality grade. Grade "A" select stock. Lumber core shall be constructed of solid random width strips not less than 2" wide nor more than 3 1/2" wide by 1" thick. Wood strips will be free from knots or other defects. All strips will be tightly joined using water resistance adhesives.

HIGH PRESSURE LAMINATE: Work surface laminate shall be .050" thick and used with balancing backer sheet of no less than .028" thick. Laminate shall conform to standards set by the American Standards Institute/National Electrical Manufacturers Association (ANSI/NEMA) for thickness, performance and appearance. Printed colours, abstract patterns and wood grains are reproduced from representative segments of large sheets and may differ slightly from the actual product.

FINISHING PROCEDURES: All materials shall be inspected and treated with a final sanding and polishing operation before any staining and final finishing can be performed. All machine and mill marks are to be removed. Once the polishing and sanding has been performed, the furniture will then undergo the following stain and finishing procedures:

- Step 1 A base stain will be uniformly applied, wiped and then allowed to dry under factory controlled conditions.
- Step 2 A uniform coat of sealer will be applied and allowed to dry.
- Step 3 Sealer will be lightly sanded using 240 grit silicon paper.
- Step 4 A catalytic lacquer of 34-45 degree sheen is evenly applied and allowed to dry under factory controlled conditions.

METAL PAINT:

Thermal Paint Colours



White
PS-111-W374



Antique White
W11



Beige
H23

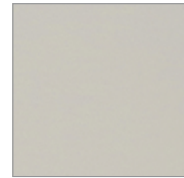

Desert
H432



Red
R66



Ruby
R7



Blue
B11



Navy
B17



Zinc
A67



Hydro Green
G96



Green
G58



Grey
A16



Charcoal
A230



Black
N49



Pebble
M237

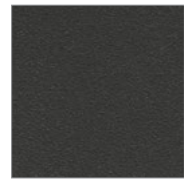

Black Sandtex
N31





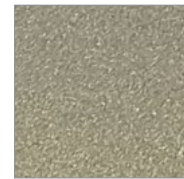



Sparkling Silver
S11

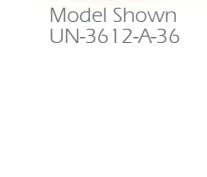

Champagne
S14

METAL FINISHING PROCEDURES: All metal components are thoroughly cleaned and coated electrostatically with an epoxy powder coat paint finish. The metal components are then oven baked and cured for a lasting finish.

MODEL NUMBER	PRODUCT	WIDTH	DEPTH	HEIGHT	SHELF DEPTH	# OF SHELVES	# OF OPENINGS	WEIGHT	VOLUME	LIST PRICE	DESCRIPTION
 Model Shown UN-3012-S-36	UN-3010-S-24	Single Face Shelving	25 1/4"	10"	30"	9 1/2"	2			\$ 1,119	Back frame is made of a double 1" x 1" metal tube, with powder coat finish. End panel is made of 1" thick, 11-ply solid core with grade "A" veneer on two sides. Edge band is 1/4" external hardwood. Comes with adjustable upper shelves and one fixed bottom shelf. Low back metal shelves with a 1 1/4" high book stop. Shelf depths are 9 1/2", 11 1/2" and 14". Standard pricing is used for natural finishes on Maple or Oak veneer – Add 10% for stained finishes on Maple or Oak veneers. Add 20% to List pricing for natural finishes on Cherry or Walnut veneer - Add 30% for stained finishes on Cherry or Walnut veneers.
	UN-3010-A-24	Single Face Adder	24 1/4"	10"	30"	9 1/2"	2			\$ 881	
	UN-3012-S-24	Single Face Shelving	25 1/4"	12"	30"	11 1/2"	2			\$ 1,181	
	UN-3012-A-24	Single Face Adder	24 1/4"	12"	30"	11 1/2"	2			\$ 925	
 Model Shown UN-3612-A-36	UN-3010-S-30	Single Face Shelving	31 1/4"	10"	30"	9 1/2"	2			\$ 1,119	
	UN-3010-A-30	Single Face Adder	30 1/4"	10"	30"	9 1/2"	2			\$ 881	
	UN-3012-S-30	Single Face Shelving	31 1/4"	12"	30"	11 1/2"	2			\$ 1,181	
	UN-3012-A-30	Single Face Adder	30 1/4"	12"	30"	11 1/2"	2			\$ 925	
 Model Shown UN-3612-A-36	UN-3010-S-36	Single Face Shelving	37 1/4"	10"	30"	9 1/2"	2			\$ 1,069	
	UN-3010-A-36	Single Face Adder	36 1/4"	10"	30"	9 1/2"	2			\$ 838	
	UN-3012-S-36	Single Face Shelving	37 1/4"	12"	30"	11 1/2"	2			\$ 1,131	
	UN-3012-A-36	Single Face Adder	36 1/4"	12"	30"	11 1/2"	2			\$ 881	
	UN-3610-S-24	Single Face Shelving	25 1/4"	10"	36"	9 1/2"	2			\$ 1,169	
	UN-3610-A-24	Single Face Adder	24 1/4"	10"	36"	9 1/2"	2			\$ 906	
	UN-3612-S-24	Single Face Shelving	25 1/4"	12"	36"	11 1/2"	2			\$ 1,231	
	UN-3612-A-24	Single Face Adder	24 1/4"	12"	36"	11 1/2"	2			\$ 944	
	UN-3614-S-24	Single Face Shelving	25 1/4"	14"	36"	14"	2			\$ 1,288	
	UN-3614-A-24	Single Face Adder	24 1/4"	14"	36"	14"	2			\$ 994	
	UN-3610-S-30	Single Face Shelving	31 1/4"	10"	36"	9 1/2"	2			\$ 1,169	
	UN-3610-A-30	Single Face Adder	30 1/4"	10"	36"	9 1/2"	2			\$ 906	
	UN-3612-S-30	Single Face Shelving	31 1/4"	12"	36"	11 1/2"	2			\$ 1,231	
	UN-3612-A-30	Single Face Adder	30 1/4"	12"	36"	11 1/2"	2			\$ 944	
	UN-3614-S-30	Single Face Shelving	31 1/4"	14"	36"	14"	2			\$ 1,288	
	UN-3614-A-30	Single Face Adder	30 1/4"	14"	36"	14"	2			\$ 994	
	UN-3610-S-36	Single Face Shelving	37 1/4"	10"	36"	9 1/2"	2			\$ 1,113	
	UN-3610-A-36	Single Face Adder	36 1/4"	10"	36"	9 1/2"	2			\$ 856	
	UN-3612-S-36	Single Face Shelving	37 1/4"	12"	36"	11 1/2"	2			\$ 1,169	
	UN-3612-A-36	Single Face Adder	36 1/4"	12"	36"	11 1/2"	2			\$ 906	
	UN-3614-S-36	Single Face Shelving	37 1/4"	14"	36"	14"	2			\$ 1,231	
	UN-3614-A-36	Single Face Adder	36 1/4"	14"	36"	14"	2			\$ 944	

MODEL NUMBER	PRODUCT	WIDTH	DEPTH	HEIGHT	SHELF DEPTH	# OF SHELVES	# OF OPENINGS	WEIGHT	VOLUME	LIST PRICE	DESCRIPTION
	UN-4210-S-24	Single Face Shelving	25 1/4"	10"	42"	9 1/2"	3			\$ 1,306	Back frame is made of a double 1" x 1" metal tube, with powder coat finish. End panel is made of 1" thick, 11-ply solid core with grade "A" veneer on two sides. Edge band is 1/4" external hardwood. Comes with adjustable upper shelves and one fixed bottom shelf. Low back metal shelves with a 1 1/4" high book stop. Shelf depths are 9 1/2", 11 1/2" and 14".
	UN-4210-A-24	Single Face Adder	24 1/4"	10"	42"	9 1/2"	3			\$ 1,013	
	UN-4212-S-24	Single Face Shelving	25 1/4"	12"	42"	11 1/2"	3			\$ 1,369	
	UN-4212-A-24	Single Face Adder	24 1/4"	12"	42"	11 1/2"	3			\$ 1,063	
	UN-4214-S-24	Single Face Shelving	25 1/4"	14"	42"	14"	3			\$ 1,444	
	UN-4214-A-24	Single Face Adder	24 1/4"	14"	42"	14"	3			\$ 1,119	
	UN-4210-S-30	Single Face Shelving	31 1/4"	10"	42"	9 1/2"	3			\$ 1,306	
	UN-4210-A-30	Single Face Adder	30 1/4"	10"	42"	9 1/2"	3			\$ 1,013	
	UN-4212-S-30	Single Face Shelving	31 1/4"	12"	42"	11 1/2"	3			\$ 1,369	
	UN-4212-A-30	Single Face Adder	30 1/4"	12"	42"	11 1/2"	3			\$ 1,063	
	UN-4214-S-30	Single Face Shelving	31 1/4"	14"	42"	14"	3			\$ 1,444	
	UN-4214-A-30	Single Face Adder	30 1/4"	14"	42"	14"	3			\$ 1,119	
	UN-4210-S-36	Single Face Shelving	37 1/4"	10"	42"	9 1/2"	3			\$ 1,244	Standard pricing is used for natural finishes on Maple or Oak veneer – Add 10% for stained finishes on Maple or Oak veneers. Add 20% to List pricing for natural finishes on Cherry or Walnut veneer - Add 30% for stained finishes on Cherry or Walnut veneers.
	UN-4210-A-36	Single Face Adder	36 1/4"	10"	42"	9 1/2"	3			\$ 963	
	UN-4212-S-36	Single Face Shelving	37 1/4"	12"	42"	11 1/2"	3			\$ 1,306	
	UN-4212-A-36	Single Face Adder	36 1/4"	12"	42"	11 1/2"	3			\$ 1,013	
	UN-4214-S-36	Single Face Shelving	37 1/4"	14"	42"	14"	3			\$ 1,369	
	UN-4214-A-36	Single Face Adder	36 1/4"	14"	42"	14"	3			\$ 1,063	
	UN-4810-S-24	Single Face Shelving	25 1/4"	10"	48"	9 1/2"	3			\$ 1,350	
	UN-4810-A-24	Single Face Adder	24 1/4"	10"	48"	9 1/2"	3			\$ 1,031	
	UN-4812-S-24	Single Face Shelving	25 1/4"	12"	48"	11 1/2"	3			\$ 1,425	
	UN-4812-A-24	Single Face Adder	24 1/4"	12"	48"	11 1/2"	3			\$ 1,088	
	UN-4814-S-24	Single Face Shelving	25 1/4"	14"	48"	14"	3			\$ 1,494	
	UN-4814-A-24	Single Face Adder	24 1/4"	14"	48"	14"	3			\$ 1,138	
	UN-4810-S-30	Single Face Shelving	31 1/4"	10"	48"	9 1/2"	3			\$ 1,350	
	UN-4810-A-30	Single Face Adder	30 1/4"	10"	48"	9 1/2"	3			\$ 1,031	
	UN-4812-S-30	Single Face Shelving	31 1/4"	12"	48"	11 1/2"	3			\$ 1,425	
	UN-4812-A-30	Single Face Adder	30 1/4"	12"	48"	11 1/2"	3			\$ 1,088	
	UN-4814-S-30	Single Face Shelving	31 1/4"	14"	48"	14"	3			\$ 1,494	
	UN-4814-A-30	Single Face Adder	30 1/4"	14"	48"	14"	3			\$ 1,138	
	UN-4810-S-36	Single Face Shelving	37 1/4"	10"	48"	9 1/2"	3			\$ 1,288	
	UN-4810-A-36	Single Face Adder	36 1/4"	10"	48"	9 1/2"	3			\$ 981	
	UN-4812-S-36	Single Face Shelving	37 1/4"	12"	48"	11 1/2"	3			\$ 1,356	
	UN-4812-A-36	Single Face Adder	36 1/4"	12"	48"	11 1/2"	3			\$ 1,038	
	UN-4814-S-36	Single Face Shelving	37 1/4"	14"	48"	14"	3			\$ 1,425	
	UN-4814-A-36	Single Face Adder	36 1/4"	14"	48"	14"	3			\$ 1,088	

SHELVING

MODEL NUMBER	PRODUCT	WIDTH	DEPTH	HEIGHT	SHELF DEPTH	# OF SHELVES	# OF OPENINGS	WEIGHT	VOLUME	LIST PRICE	DESCRIPTION
--------------	---------	-------	-------	--------	-------------	--------------	---------------	--------	--------	------------	-------------



Model Shown
UN-6012-S-36

UN-6010-S-24	Single Face Shelving	25 1/4"	10"	60"	9 1/2"	4	4			\$ 1,694	Back frame is made of a double 1" x 1" metal tube, with powder coat finish. End panel is made of 1" thick, 11-ply solid core with grade "A" veneer on two sides. Edge band is 1/4" external hardwood. Comes with adjustable upper shelves and one fixed bottom shelf. Low back metal shelves with a 1 1/4" high book stop. Shelf depths are 9 1/2", 11 1/2" and 14".
UN-6010-A-24	Single Face Adder	24 1/4"	10"	60"	9 1/2"	4	4			\$ 1,344	
UN-6012-S-24	Single Face Shelving	25 1/4"	12"	60"	11 1/2"	4	4			\$ 1,788	
UN-6012-A-24	Single Face Adder	24 1/4"	12"	60"	11 1/2"	4	4			\$ 1,419	
UN-6014-S-24	Single Face Shelving	25 1/4"	14"	60"	14"	4	4			\$ 1,875	
UN-6014-A-24	Single Face Adder	24 1/4"	14"	60"	14"	4	4			\$ 1,488	

UN-6010-S-30	Single Face Shelving	31 1/4"	10"	60"	9 1/2"	4	4			\$ 1,694	Standard pricing is used for natural finishes on Maple or Oak veneer – Add 10% for stained finishes on Maple or Oak veneers.
UN-6010-A-30	Single Face Adder	30 1/4"	10"	60"	9 1/2"	4	4			\$ 1,344	
UN-6012-S-30	Single Face Shelving	31 1/4"	12"	60"	11 1/2"	4	4			\$ 1,788	
UN-6012-A-30	Single Face Adder	30 1/4"	12"	60"	11 1/2"	4	4			\$ 1,419	
UN-6014-S-30	Single Face Shelving	31 1/4"	14"	60"	14"	4	4			\$ 1,875	
UN-6014-A-30	Single Face Adder	30 1/4"	14"	60"	14"	4	4			\$ 1,488	



Model Shown
UN-6012-A-36

UN-6010-S-36	Single Face Shelving	37 1/4"	10"	60"	9 1/2"	4	4			\$ 1,613	Add 20% to List pricing for natural finishes on Cherry or Walnut veneer - Add 30% for stained finishes on Cherry or Walnut veneers.
UN-6010-A-36	Single Face Adder	36 1/4"	10"	60"	9 1/2"	4	4			\$ 1,281	
UN-6012-S-36	Single Face Shelving	37 1/4"	12"	60"	11 1/2"	4	4			\$ 1,706	
UN-6012-A-36	Single Face Adder	36 1/4"	12"	60"	11 1/2"	4	4			\$ 1,344	
UN-6014-S-36	Single Face Shelving	37 1/4"	14"	60"	14"	4	4			\$ 1,788	
UN-6014-A-36	Single Face Adder	36 1/4"	14"	60"	14"	4	4			\$ 1,419	



Model Shown
UN-7212-S-36

UN-7210-S-24	Single Face Shelving	25 1/4"	10"	72"	9 1/2"	5	5			\$ 1,681	
UN-7210-A-24	Single Face Adder	24 1/4"	10"	72"	9 1/2"	5	5			\$ 1,288	
UN-7212-S-24	Single Face Shelving	25 1/4"	12"	72"	11 1/2"	5	5			\$ 1,769	
UN-7212-A-24	Single Face Adder	24 1/4"	12"	72"	11 1/2"	5	5			\$ 1,350	
UN-7214-S-24	Single Face Shelving	25 1/4"	14"	72"	14"	5	5			\$ 1,856	
UN-7214-A-24	Single Face Adder	24 1/4"	14"	72"	14"	5	5			\$ 1,419	







UN-7210-S-30	Single Face Shelving	31 1/4"	10"	72"	9 1/2"	5	5			\$ 1,681
UN-7210-A-30	Single Face Adder	30 1/4"	10"	72"	9 1/2"	5	5			\$ 1,288
UN-7212-S-30	Single Face Shelving	31 1/4"	12"	72"	11 1/2"	5	5			\$ 1,769
UN-7212-A-30	Single Face Adder	30 1/4"	12"	72"	11 1/2"	5	5			\$ 1,350
UN-7214-S-30	Single Face Shelving	31 1/4"	14"	72"	14"	5	5			\$ 1,856
UN-7214-A-30	Single Face Adder	30 1/4"	14"	72"	14"	5	5			\$ 1,419





Model Shown
UN-7212-A-36

UN-7210-S-36	Single Face Shelving	37 1/4"	10"	72"	9 1/2"	5	5			\$ 1,600
UN-7210-A-36	Single Face Adder	36 1/4"	10"	72"	9 1/2"	5	5			\$ 1,225
UN-7212-S-36	Single Face Shelving	37 1/4"	12"	72"	11 1/2"	5	5			\$ 1,681
UN-7212-A-36	Single Face Adder	36 1/4"	12"	72"	11 1/2"	5	5			\$ 1,288
UN-7214-S-36	Single Face Shelving	37 1/4"	14"	72"	14"	5	5			\$ 1,769
UN-7214-A-36	Single Face Adder	36 1/4"	14"	72"	14"	5	5			\$ 1,350

SHELVING

MODEL NUMBER	PRODUCT	WIDTH	DEPTH	HEIGHT	SHELF DEPTH	# OF SHELVES	# OF OPENINGS	WEIGHT	VOLUME	LIST PRICE	DESCRIPTION
 Model Shown UN-8412-S-36	UN-8410-S-24	Single Face Shelving	25 1/4"	10"	84"	9 1/2"	6			\$ 1,838	Back frame is made of a double 1" x 1" metal tube, with powder coat finish. End panel is made of 1" thick, 11-ply solid core with grade "A" veneer on two sides. Edge band is 1/4" external hardwood. Comes with adjustable upper shelves and one fixed bottom shelf. Low back metal shelves with a 1 1/4" high book stop. Shelf depths are 9 1/2", 11 1/2" and 14". Standard pricing is used for natural finishes on Maple or Oak veneer – Add 10% for stained finishes on Maple or Oak veneers. Add 20% to List pricing for natural finishes on Cherry or Walnut veneer - Add 30% for stained finishes on Cherry or Walnut veneers.
	UN-8410-A-24	Single Face Adder	24 1/4"	10"	84"	9 1/2"	6			\$ 1,406	
	UN-8412-S-24	Single Face Shelving	25 1/4"	12"	84"	11 1/2"	6			\$ 1,938	
	UN-8412-A-24	Single Face Adder	24 1/4"	12"	84"	11 1/2"	6			\$ 1,475	
	UN-8414-S-24	Single Face Shelving	25 1/4"	14"	84"	14"	6			\$ 2,031	
	UN-8414-A-24	Single Face Adder	24 1/4"	14"	84"	14"	6			\$ 1,550	
 Model Shown UN-8412-A-36	UN-8410-S-30	Single Face Shelving	31 1/4"	10"	84"	9 1/2"	6			\$ 1,838	
	UN-8410-A-30	Single Face Adder	30 1/4"	10"	84"	9 1/2"	6			\$ 1,406	
	UN-8412-S-30	Single Face Shelving	31 1/4"	12"	84"	11 1/2"	6			\$ 1,938	
	UN-8412-A-30	Single Face Adder	30 1/4"	12"	84"	11 1/2"	6			\$ 1,475	
	UN-8414-S-30	Single Face Shelving	31 1/4"	14"	84"	14"	6			\$ 2,031	
	UN-8414-A-30	Single Face Adder	30 1/4"	14"	84"	14"	6			\$ 1,550	
 Model Shown UN-8412-S-36	UN-8410-S-36	Single Face Shelving	37 1/4"	10"	84"	9 1/2"	6			\$ 1,750	
	UN-8410-A-36	Single Face Adder	36 1/4"	10"	84"	9 1/2"	6			\$ 1,338	
	UN-8412-S-36	Single Face Shelving	37 1/4"	12"	84"	11 1/2"	6			\$ 1,844	
	UN-8412-A-36	Single Face Adder	36 1/4"	12"	84"	11 1/2"	6			\$ 1,406	
	UN-8414-S-36	Single Face Shelving	37 1/4"	14"	84"	14"	6			\$ 1,938	
	UN-8414-A-36	Single Face Adder	36 1/4"	14"	84"	14"	6			\$ 1,475	
 Model Shown UN-9612-S-36	UN-9610-S-24	Single Face Shelving	25 1/4"	10"	96"	9 1/2"	7			\$ 2,006	
	UN-9610-A-24	Single Face Adder	24 1/4"	10"	96"	9 1/2"	7			\$ 1,531	
	UN-9612-S-24	Single Face Shelving	25 1/4"	12"	96"	11 1/2"	7			\$ 2,106	
	UN-9612-A-24	Single Face Adder	24 1/4"	12"	96"	11 1/2"	7			\$ 1,606	
	UN-9614-S-24	Single Face Shelving	25 1/4"	14"	96"	14"	7			\$ 2,213	
	UN-9614-A-24	Single Face Adder	24 1/4"	14"	96"	14"	7			\$ 1,681	
 Model Shown UN-9612-S-36	UN-9610-S-30	Single Face Shelving	31 1/4"	10"	96"	9 1/2"	7			\$ 2,006	
	UN-9610-A-30	Single Face Adder	30 1/4"	10"	96"	9 1/2"	7			\$ 1,531	
	UN-9612-S-30	Single Face Shelving	31 1/4"	12"	96"	11 1/2"	7			\$ 2,106	
	UN-9612-A-30	Single Face Adder	30 1/4"	12"	96"	11 1/2"	7			\$ 1,606	
	UN-9614-S-30	Single Face Shelving	31 1/4"	14"	96"	14"	7			\$ 2,213	
	UN-9614-A-30	Single Face Adder	30 1/4"	14"	96"	14"	7			\$ 1,681	
 Model Shown UN-9612-S-36	UN-9610-S-36	Single Face Shelving	37 1/4"	10"	96"	9 1/2"	7			\$ 1,913	
	UN-9610-A-36	Single Face Adder	36 1/4"	10"	96"	9 1/2"	7			\$ 1,456	
	UN-9612-S-36	Single Face Shelving	37 1/4"	12"	96"	11 1/2"	7			\$ 2,006	
	UN-9612-A-36	Single Face Adder	36 1/4"	12"	96"	11 1/2"	7			\$ 1,531	
	UN-9614-S-36	Single Face Shelving	37 1/4"	14"	96"	14"	7			\$ 2,106	
	UN-9614-A-36	Single Face Adder	36 1/4"	14"	96"	14"	7			\$ 1,606	

SHELVING

MODEL NUMBER	PRODUCT	WIDTH	DEPTH	HEIGHT	SHELF DEPTH	# OF SHELVES	# OF OPENINGS	WEIGHT	VOLUME	LIST PRICE	DESCRIPTION
 Model Shown UN-3020-S-24	UN-3020-S-24	Double Face Shelving	25 1/4"	20"	30"	9 1/2"	4			\$ ____	Back frame is made of a double 1" x 1" metal tube, with powder coat finish. End panel is made of 1" thick, 11-ply solid core with grade "A" veneer on two sides. Edge band is 1/4" external hardwood. Comes with adjustable upper shelves and one fixed bottom shelf. Low back metal shelves with a 1 1/4" high book stop. Shelf depths are 9 1/2", 11 1/2" and 14". Standard pricing is used for natural finishes on Maple or Oak veneer – Add 10% for stained finishes on Maple or Oak veneers. Add 20% to List pricing for natural finishes on Cherry or Walnut veneer - Add 30% for stained finishes on Cherry or Walnut veneers.
	UN-3020-A-24	Double Face Adder	24 1/4"	20"	30"	9 1/2"	4			\$ ____	
	UN-3024-S-24	Double Face Shelving	25 1/4"	24"	30"	11 1/2"	4			\$ ____	
	UN-3024-A-24	Double Face Adder	24 1/4"	24"	30"	11 1/2"	4			\$ ____	
 Model Shown UN-3020-S-30	UN-3020-S-30	Double Face Shelving	31 1/4"	20"	30"	9 1/2"	4			\$ ____	
	UN-3020-A-30	Double Face Adder	30 1/4"	20"	30"	9 1/2"	4			\$ ____	
	UN-3024-S-30	Double Face Shelving	31 1/4"	24"	30"	11 1/2"	4			\$ ____	
	UN-3024-A-30	Double Face Adder	30 1/4"	24"	30"	11 1/2"	4			\$ ____	
 Model Shown UN-3020-S-36	UN-3020-S-36	Double Face Shelving	37 1/4"	20"	30"	9 1/2"	4			\$ ____	
	UN-3020-A-36	Double Face Adder	36 1/4"	20"	30"	9 1/2"	4			\$ ____	
	UN-3024-S-36	Double Face Shelving	37 1/4"	24"	30"	11 1/2"	4			\$ ____	
	UN-3024-A-36	Double Face Adder	36 1/4"	24"	30"	11 1/2"	4			\$ ____	
	UN-3620-S-24	Double Face Shelving	25 1/4"	20"	36"	9 1/2"	4			\$ 1,488	
	UN-3620-A-24	Double Face Adder	24 1/4"	20"	36"	9 1/2"	4			\$ 1,163	
	UN-3624-S-24	Double Face Shelving	25 1/4"	24"	36"	11 1/2"	4			\$ 1,556	
	UN-3624-A-24	Double Face Adder	24 1/4"	24"	36"	11 1/2"	4			\$ 1,225	
	UN-3628-S-24	Double Face Shelving	25 1/4"	28"	36"	14"	4			\$ 1,638	
	UN-3628-A-24	Double Face Adder	24 1/4"	28"	36"	14"	4			\$ 1,281	
	UN-3620-S-30	Double Face Shelving	31 1/4"	20"	36"	9 1/2"	4			\$ 1,488	
	UN-3620-A-30	Double Face Adder	30 1/4"	20"	36"	9 1/2"	4			\$ 1,163	
	UN-3624-S-30	Double Face Shelving	31 1/4"	24"	36"	11 1/2"	4			\$ 1,556	
	UN-3624-A-30	Double Face Adder	30 1/4"	24"	36"	11 1/2"	4			\$ 1,225	
	UN-3628-S-30	Double Face Shelving	31 1/4"	28"	36"	14"	4			\$ 1,638	
	UN-3628-A-30	Double Face Adder	30 1/4"	28"	36"	14"	4			\$ 1,281	
	UN-3620-S-36	Double Face Shelving	37 1/4"	20"	36"	9 1/2"	4			\$ 1,413	
	UN-3620-A-36	Double Face Adder	36 1/4"	20"	36"	9 1/2"	4			\$ 1,106	
	UN-3624-S-36	Double Face Shelving	37 1/4"	24"	36"	11 1/2"	4			\$ 1,488	
	UN-3624-A-36	Double Face Adder	36 1/4"	24"	36"	11 1/2"	4			\$ 1,163	
	UN-3628-S-36	Double Face Shelving	37 1/4"	28"	36"	14"	4			\$ 1,556	
	UN-3628-A-36	Double Face Adder	36 1/4"	28"	36"	14"	4			\$ 1,225	

MODEL NUMBER	PRODUCT	WIDTH	DEPTH	HEIGHT	SHELF DEPTH	# OF SHELVES	# OF OPENINGS	WEIGHT	VOLUME	LIST PRICE	DESCRIPTION	
UN-4220-S-24	Double Face Shelving	25 1/4"	20"	42"	9 1/2"	6	6			\$ 1,769	Back frame is made of a double 1" x 1" metal tube, with powder coat finish. End panel is made of 1" thick, 11-ply solid core with grade "A" veneer on two sides. Edge band is 1/4" external hardwood. Comes with adjustable upper shelves and one fixed bottom shelf. Low back metal shelves with a 1 1/4" high book stop. Shelf depths are 9 1/2", 11 1/2" and 14".	
UN-4220-A-24	Double Face Adder	24 1/4"	20"	42"	9 1/2"	6	6			\$ 1,419		
UN-4224-S-24	Double Face Shelving	25 1/4"	24"	42"	11 1/2"	6	6			\$ 1,863		
UN-4224-A-24	Double Face Adder	24 1/4"	24"	42"	11 1/2"	6	6			\$ 1,488		
UN-4228-S-24	Double Face Shelving	25 1/4"	28"	42"	14"	6	6			\$ 1,956		
UN-4228-A-24	Double Face Adder	24 1/4"	28"	42"	14"	6	6			\$ 1,556		
UN-4220-S-30	Double Face Shelving	31 1/4"	20"	42"	9 1/2"	6	6			\$ 1,769		
UN-4220-A-30	Double Face Adder	30 1/4"	20"	42"	9 1/2"	6	6			\$ 1,419		
UN-4224-S-30	Double Face Shelving	31 1/4"	24"	42"	11 1/2"	6	6			\$ 1,863		
UN-4224-A-30	Double Face Adder	30 1/4"	24"	42"	11 1/2"	6	6			\$ 1,488		
UN-4228-S-30	Double Face Shelving	31 1/4"	28"	42"	14"	6	6			\$ 1,956		
UN-4228-A-30	Double Face Adder	30 1/4"	28"	42"	14"	6	6			\$ 1,556		
UN-4220-S-36	Double Face Shelving	37 1/4"	20"	42"	9 1/2"	6	6			\$ 1,681	Standard pricing is used for natural finishes on Maple or Oak veneer – Add 10% for stained finishes on Maple or Oak veneers.	
UN-4220-A-36	Double Face Adder	36 1/4"	20"	42"	9 1/2"	6	6			\$ 1,344		
UN-4224-S-36	Double Face Shelving	37 1/4"	24"	42"	11 1/2"	6	6			\$ 1,769		
UN-4224-A-36	Double Face Adder	36 1/4"	24"	42"	11 1/2"	6	6			\$ 1,419		
UN-4228-S-36	Double Face Shelving	37 1/4"	28"	42"	14"	6	6			\$ 1,863		
UN-4228-A-36	Double Face Adder	36 1/4"	28"	42"	14"	6	6			\$ 1,488		
UN-4820-S-24	Double Face Shelving	25 1/4"	20"	48"	9 1/2"	6	6			\$ 1,831		Add 20% to List pricing for natural finishes on Cherry or Walnut veneer - Add 30% for stained finishes on Cherry or Walnut veneers.
UN-4820-A-24	Double Face Adder	24 1/4"	20"	48"	9 1/2"	6	6			\$ 1,444		
UN-4824-S-24	Double Face Shelving	25 1/4"	24"	48"	11 1/2"	6	6			\$ 1,925		
UN-4824-A-24	Double Face Adder	24 1/4"	24"	48"	11 1/2"	6	6			\$ 1,519		
UN-4828-S-24	Double Face Shelving	25 1/4"	28"	48"	14"	6	6			\$ 2,019		
UN-4828-A-24	Double Face Adder	24 1/4"	28"	48"	14"	6	6			\$ 1,594		
UN-4820-S-30	Double Face Shelving	31 1/4"	20"	48"	9 1/2"	6	6			\$ 1,831		
UN-4820-A-30	Double Face Adder	30 1/4"	20"	48"	9 1/2"	6	6			\$ 1,444		
UN-4824-S-30	Double Face Shelving	31 1/4"	24"	48"	11 1/2"	6	6			\$ 1,925		
UN-4824-A-30	Double Face Adder	30 1/4"	24"	48"	11 1/2"	6	6			\$ 1,519		
UN-4828-S-30	Double Face Shelving	31 1/4"	28"	48"	14"	6	6			\$ 2,019		
UN-4828-A-30	Double Face Adder	30 1/4"	28"	48"	14"	6	6			\$ 1,594		
UN-4820-S-36	Double Face Shelving	37 1/4"	20"	48"	9 1/2"	6	6			\$ 1,744		
UN-4820-A-36	Double Face Adder	36 1/4"	20"	48"	9 1/2"	6	6			\$ 1,369		
UN-4824-S-36	Double Face Shelving	37 1/4"	24"	48"	11 1/2"	6	6			\$ 1,831		
UN-4824-A-36	Double Face Adder	36 1/4"	24"	48"	11 1/2"	6	6			\$ 1,444		
UN-4828-S-36	Double Face Shelving	37 1/4"	28"	48"	14"	6	6			\$ 1,925		
UN-4828-A-36	Double Face Adder	36 1/4"	28"	48"	14"	6	6			\$ 1,519		



Model Shown
UN-4824-S-36



Model Shown
UN-4824-A-36

MODEL NUMBER	PRODUCT	WIDTH	DEPTH	HEIGHT	SHELF DEPTH	# OF SHELVES	# OF OPENINGS	WEIGHT	VOLUME	LIST PRICE	DESCRIPTION
--------------	---------	-------	-------	--------	-------------	--------------	---------------	--------	--------	------------	-------------

UN-6020-S-24	Double Face Shelving	25 1/4"	20"	60"	9 1/2"	8	8			\$ 2,269	Back frame is made of a double 1" x 1" metal tube, with powder coat finish. End panel is made of 1" thick, 11-ply solid core with grade "A" veneer on two sides. Edge band is 1/4" external hardwood. Comes with adjustable upper shelves and one fixed bottom shelf. Low back metal shelves with a 1 1/4" high book stop. Shelf depths are 9 1/2", 11 1/2" and 14".
UN-6020-A-24	Double Face Adder	24 1/4"	20"	60"	9 1/2"	8	8			\$ 1,844	
UN-6024-S-24	Double Face Shelving	25 1/4"	24"	60"	11 1/2"	8	8			\$ 2,381	
UN-6024-A-24	Double Face Adder	24 1/4"	24"	60"	11 1/2"	8	8			\$ 1,938	
UN-6028-S-24	Double Face Shelving	25 1/4"	28"	60"	14"	8	8			\$ 2,500	
UN-6028-A-24	Double Face Adder	24 1/4"	28"	60"	14"	8	8			\$ 2,031	

UN-6020-S-30	Double Face Shelving	31 1/4"	20"	60"	9 1/2"	8	8			\$ 2,269	Standard pricing is used for natural finishes on Maple or Oak veneer – Add 10% for stained finishes on Maple or Oak veneers.
UN-6020-A-30	Double Face Adder	30 1/4"	20"	60"	9 1/2"	8	8			\$ 1,844	
UN-6024-S-30	Double Face Shelving	31 1/4"	24"	60"	11 1/2"	8	8			\$ 2,381	
UN-6024-A-30	Double Face Adder	30 1/4"	24"	60"	11 1/2"	8	8			\$ 1,938	
UN-6028-S-30	Double Face Shelving	31 1/4"	28"	60"	14"	8	8			\$ 2,500	
UN-6028-A-30	Double Face Adder	30 1/4"	28"	60"	14"	8	8			\$ 2,031	

UN-6020-S-36	Double Face Shelving	37 1/4"	20"	60"	9 1/2"	8	8			\$ 2,156	Add 20% to List pricing for natural finishes on Cherry or Walnut veneer - Add 30% for stained finishes on Cherry or Walnut veneers.
UN-6020-A-36	Double Face Adder	36 1/4"	20"	60"	9 1/2"	8	8			\$ 1,750	
UN-6024-S-36	Double Face Shelving	37 1/4"	24"	60"	11 1/2"	8	8			\$ 2,269	
UN-6024-A-36	Double Face Adder	36 1/4"	24"	60"	11 1/2"	8	8			\$ 1,844	
UN-6028-S-36	Double Face Shelving	37 1/4"	28"	60"	14"	8	8			\$ 2,381	
UN-6028-A-36	Double Face Adder	36 1/4"	28"	60"	14"	8	8			\$ 1,938	

UN-7220-S-24	Double Face Shelving	25 1/4"	20"	72"	9 1/2"	10	10			\$ 2,288	
UN-7220-A-24	Double Face Adder	24 1/4"	20"	72"	9 1/2"	10	10			\$ 1,813	
UN-7224-S-24	Double Face Shelving	25 1/4"	24"	72"	11 1/2"	10	10			\$ 2,400	
UN-7224-A-24	Double Face Adder	24 1/4"	24"	72"	11 1/2"	10	10			\$ 1,900	
UN-7228-S-24	Double Face Shelving	25 1/4"	28"	72"	14"	10	10			\$ 2,519	
UN-7228-A-24	Double Face Adder	24 1/4"	28"	72"	14"	10	10			\$ 1,994	

UN-7220-S-30	Double Face Shelving	31 1/4"	20"	72"	9 1/2"	10	10			\$ 2,288	
UN-7220-A-30	Double Face Adder	30 1/4"	20"	72"	9 1/2"	10	10			\$ 1,813	
UN-7224-S-30	Double Face Shelving	31 1/4"	24"	72"	11 1/2"	10	10			\$ 2,400	
UN-7224-A-30	Double Face Adder	30 1/4"	24"	72"	11 1/2"	10	10			\$ 1,900	
UN-7228-S-30	Double Face Shelving	31 1/4"	28"	72"	14"	10	10			\$ 2,519	
UN-7228-A-30	Double Face Adder	30 1/4"	28"	72"	14"	10	10			\$ 1,994	

UN-7220-S-36	Double Face Shelving	37 1/4"	20"	72"	9 1/2"	10	10			\$ 2,175	
UN-7220-A-36	Double Face Adder	36 1/4"	20"	72"	9 1/2"	10	10			\$ 1,725	
UN-7224-S-36	Double Face Shelving	37 1/4"	24"	72"	11 1/2"	10	10			\$ 2,288	
UN-7224-A-36	Double Face Adder	36 1/4"	24"	72"	11 1/2"	10	10			\$ 1,813	
UN-7228-S-36	Double Face Shelving	37 1/4"	28"	72"	14"	10	10			\$ 2,400	
UN-7228-A-36	Double Face Adder	36 1/4"	28"	72"	14"	10	10			\$ 1,900	



Model Shown
UN-6024-S-36



Model Shown
UN-6024-A-36









Model Shown
UN-7224-S-36





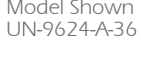



Model Shown
UN-7224-A-36

SHELVING

MODEL NUMBER	PRODUCT	WIDTH	DEPTH	HEIGHT	SHELF DEPTH	# OF SHELVES	# OF OPENINGS	WEIGHT	VOLUME	LIST PRICE	DESCRIPTION
 Model Shown UN-8424-S-36	UN-8420-S-24	Double Face Shelving	25 1/4"	20"	84"	9 1/2"	12			\$ 2,544	Back frame is made of a double 1" x 1" metal tube, with powder coat finish. End panel is made of 1" thick, 11-ply solid core with grade "A" veneer on two sides. Edge band is 1/4" external hardwood. Comes with adjustable upper shelves and one fixed bottom shelf. Low back metal shelves with a 1 1/4" high book stop. Shelf depths are 9 1/2", 11 1/2" and 14".
	UN-8420-A-24	Double Face Adder	24 1/4"	20"	84"	9 1/2"	12			\$ 2,019	
	UN-8424-S-24	Double Face Shelving	25 1/4"	24"	84"	11 1/2"	12			\$ 2,669	
	UN-8424-A-24	Double Face Adder	24 1/4"	24"	84"	11 1/2"	12			\$ 2,119	
	UN-8428-S-24	Double Face Shelving	25 1/4"	28"	84"	14"	12			\$ 2,806	
	UN-8428-A-24	Double Face Adder	24 1/4"	28"	84"	14"	12			\$ 2,219	
 Model Shown UN-8424-A-36	UN-8420-S-30	Double Face Shelving	31 1/4"	20"	84"	9 1/2"	12			\$ 2,544	
	UN-8420-A-30	Double Face Adder	30 1/4"	20"	84"	9 1/2"	12			\$ 2,019	
	UN-8424-S-30	Double Face Shelving	31 1/4"	24"	84"	11 1/2"	12			\$ 2,669	
	UN-8424-A-30	Double Face Adder	30 1/4"	24"	84"	11 1/2"	12			\$ 2,119	
	UN-8428-S-30	Double Face Shelving	31 1/4"	28"	84"	14"	12			\$ 2,806	
	UN-8428-A-30	Double Face Adder	30 1/4"	28"	84"	14"	12			\$ 2,219	
 Model Shown UN-8424-A-36	UN-8420-S-36	Double Face Shelving	37 1/4"	20"	84"	9 1/2"	12			\$ 2,413	
	UN-8420-A-36	Double Face Adder	36 1/4"	20"	84"	9 1/2"	12			\$ 1,919	
	UN-8424-S-36	Double Face Shelving	37 1/4"	24"	84"	11 1/2"	12			\$ 2,544	
	UN-8424-A-36	Double Face Adder	36 1/4"	24"	84"	11 1/2"	12			\$ 2,019	
	UN-8428-S-36	Double Face Shelving	37 1/4"	28"	84"	14"	12			\$ 2,669	
	UN-8428-A-36	Double Face Adder	36 1/4"	28"	84"	14"	12			\$ 2,119	
 Model Shown UN-9624-A-36	UN-9620-S-24	Double Face Shelving	25 1/4"	20"	96"	9 1/2"	14			\$ 2,800	
	UN-9620-A-24	Double Face Adder	24 1/4"	20"	96"	9 1/2"	14			\$ 2,225	
	UN-9624-S-24	Double Face Shelving	25 1/4"	24"	96"	11 1/2"	14			\$ 2,938	
	UN-9624-A-24	Double Face Adder	24 1/4"	24"	96"	11 1/2"	14			\$ 2,344	
	UN-9628-S-24	Double Face Shelving	25 1/4"	28"	96"	14"	14			\$ 3,088	
	UN-9628-A-24	Double Face Adder	24 1/4"	28"	96"	14"	14			\$ 2,456	
 Model Shown UN-9624-A-36	UN-9620-S-30	Double Face Shelving	31 1/4"	20"	96"	9 1/2"	14			\$ 2,800	
	UN-9620-A-30	Double Face Adder	30 1/4"	20"	96"	9 1/2"	14			\$ 2,225	
	UN-9624-S-30	Double Face Shelving	31 1/4"	24"	96"	11 1/2"	14			\$ 2,938	
	UN-9624-A-30	Double Face Adder	30 1/4"	24"	96"	11 1/2"	14			\$ 2,344	
	UN-9628-S-30	Double Face Shelving	31 1/4"	28"	96"	14"	14			\$ 3,088	
	UN-9628-A-30	Double Face Adder	30 1/4"	28"	96"	14"	14			\$ 2,456	
 Model Shown UN-9624-A-36	UN-9620-S-36	Double Face Shelving	37 1/4"	20"	96"	9 1/2"	14			\$ 2,663	
	UN-9620-A-36	Double Face Adder	36 1/4"	20"	96"	9 1/2"	14			\$ 2,119	
	UN-9624-S-36	Double Face Shelving	37 1/4"	24"	96"	11 1/2"	14			\$ 2,800	
	UN-9624-A-36	Double Face Adder	36 1/4"	24"	96"	11 1/2"	14			\$ 2,225	
	UN-9628-S-36	Double Face Shelving	37 1/4"	28"	96"	14"	14			\$ 2,938	
	UN-9628-A-36	Double Face Adder	36 1/4"	28"	96"	14"	14			\$ 2,344	

SHELVING

MODEL NUMBER	PRODUCT	WIDTH	DEPTH	HEIGHT	SHELF DEPTH	# OF SHELVES	# OF OPENINGS	WEIGHT	VOLUME	LIST PRICE	DESCRIPTION
 <p>Model Shown UN-3612-S-M-36</p>	UN-3012-S-M-24	Single Face Shelving	25 1/4"	12"	30"	11 1/2"	2			\$ _____	<p>Back frame is made of a double 1" x 1" metal tube, with powder coat finish. End panel is made of 1" thick, 11-ply solid core with grade "A" veneer on two sides. Edge band is 1/4" external hardwood. Comes with adjustable upper shelves and one fixed bottom shelf. Low back metal shelves with a 1 1/4" high book stop. Shelf depths are 9 1/2", 11 1/2" and 14".</p> <p>Back frame is double 1" x 1" metal tube, with beige powder coat.</p> <p>Standard pricing is used for natural finishes on Maple or Oak veneer – Add 10% for stained finishes on Maple or Oak veneers.</p> <p>Add 20% to List pricing for natural finishes on Cherry or Walnut veneer - Add 30% for stained finishes on Cherry or Walnut veneers.</p>
	UN-3012-A-M-24	Single Face Adder	24 1/4"	12"	30"	11 1/2"	2			\$ _____	
	UN-3012-S-M-30	Single Face Shelving	31 1/4"	12"	30"	11 1/2"	2			\$ _____	
	UN-3012-A-M-30	Single Face Adder	30 1/4"	12"	30"	11 1/2"	2			\$ _____	
	UN-3012-S-M-36	Single Face Shelving	37 1/4"	12"	30"	11 1/2"	2			\$ _____	
	UN-3012-A-M-36	Single Face Adder	36 1/4"	12"	30"	11 1/2"	2			\$ _____	
 <p>Model Shown UN-4812-S-M-36</p>	UN-3612-S-M-24	Single Face Shelving	25 1/4"	12"	36"	11 1/2"	2			\$ 1,525	
	UN-3612-A-M-24	Single Face Adder	24 1/4"	12"	36"	11 1/2"	2			\$ 1,244	
	UN-3612-S-M-30	Single Face Shelving	31 1/4"	12"	36"	11 1/2"	2			\$ 1,525	
	UN-3612-A-M-30	Single Face Adder	30 1/4"	12"	36"	11 1/2"	2			\$ 1,244	
	UN-3612-S-M-36	Single Face Shelving	37 1/4"	12"	36"	11 1/2"	2			\$ 1,469	
	UN-3612-A-M-36	Single Face Adder	36 1/4"	12"	36"	11 1/2"	2			\$ 1,200	
 <p>Model Shown UN-4212-S-M-36</p>	UN-4212-S-M-24	Single Face Shelving	25 1/4"	12"	42"	11 1/2"	3			\$ 1,819	
	UN-4212-A-M-24	Single Face Adder	24 1/4"	12"	42"	11 1/2"	3			\$ 1,506	
	UN-4212-S-M-30	Single Face Shelving	31 1/4"	12"	42"	11 1/2"	3			\$ 1,819	
	UN-4212-A-M-30	Single Face Adder	30 1/4"	12"	42"	11 1/2"	3			\$ 1,506	
	UN-4212-S-M-36	Single Face Shelving	37 1/4"	12"	42"	11 1/2"	3			\$ 1,756	
	UN-4212-A-M-36	Single Face Adder	36 1/4"	12"	42"	11 1/2"	3			\$ 1,456	
 <p>Model Shown UN-4812-S-M-36</p>	UN-4812-S-M-24	Single Face Shelving	25 1/4"	12"	48"	11 1/2"	3			\$ 1,869	
	UN-4812-A-M-24	Single Face Adder	24 1/4"	12"	48"	11 1/2"	3			\$ 1,525	
	UN-4812-S-M-30	Single Face Shelving	31 1/4"	12"	48"	11 1/2"	3			\$ 1,869	
	UN-4812-A-M-30	Single Face Adder	30 1/4"	12"	48"	11 1/2"	3			\$ 1,530	
	UN-4812-S-M-36	Single Face Shelving	37 1/4"	12"	48"	11 1/2"	3			\$ 1,800	
	UN-4812-A-M-36	Single Face Adder	36 1/4"	12"	48"	11 1/2"	3			\$ 1,481	

MODEL NUMBER	PRODUCT	WIDTH	DEPTH	HEIGHT	SHELF DEPTH	# OF SHELVES	# OF OPENINGS	WEIGHT	VOLUME	LIST PRICE	DESCRIPTION
	UN-6012-S-M-24	Single Face Shelving	25 1/4"	12"	60"	11 1/2"	4			\$ 2,381	Back frame is made of a double 1" x 1" metal tube, with powder coat finish. End panel is made of 1" thick, 11-ply solid core with grade "A" veneer on two sides. Edge band is 1/4" external hardwood. Comes with adjustable upper shelves and one fixed bottom shelf. Low back metal shelves with a 1 1/4" high book stop. Shelf depths are 9 1/2", 11 1/2" and 14". Back frame is double 1" x 1" metal tube, with beige powder coat. Standard pricing is used for natural finishes on Maple or Oak veneer – Add 10% for stained finishes on Maple or Oak veneers. Add 20% to List pricing for natural finishes on Cherry or Walnut veneer - Add 30% for stained finishes on Cherry or Walnut veneers.
	UN-6012-A-M-24	Single Face Adder	24 1/4"	12"	60"	11 1/2"	4			\$ 2,006	
	UN-6012-S-M-30	Single Face Shelving	31 1/4"	12"	60"	11 1/2"	4			\$ 2,381	
	UN-6012-A-M-30	Single Face Adder	30 1/4"	12"	60"	11 1/2"	4			\$ 2,006	
	UN-6012-S-M-36	Single Face Shelving	37 1/4"	12"	60"	11 1/2"	4			\$ 2,294	
	UN-6012-A-M-36	Single Face Adder	36 1/4"	12"	60"	11 1/2"	4			\$ 1,944	
	UN-7212-S-M-24	Single Face Shelving	25 1/4"	12"	72"	11 1/2"	5			\$ 2,506	
	UN-7212-A-M-24	Single Face Adder	24 1/4"	12"	72"	11 1/2"	5			\$ 2,094	
	UN-7212-S-M-30	Single Face Shelving	31 1/4"	12"	72"	11 1/2"	5			\$ 2,506	
	UN-7212-A-M-30	Single Face Adder	30 1/4"	12"	72"	11 1/2"	5			\$ 2,094	
	UN-7212-S-M-36	Single Face Shelving	37 1/4"	12"	72"	11 1/2"	5			\$ 2,425	
	UN-7212-A-M-36	Single Face Adder	36 1/4"	12"	72"	11 1/2"	5			\$ 2,031	
	UN-8412-S-M-24	Single Face Shelving	25 1/4"	12"	84"	11 1/2"	6			\$ 2,825	
	UN-8412-A-M-24	Single Face Adder	24 1/4"	12"	84"	11 1/2"	6			\$ 2,369	
	UN-8412-S-M-30	Single Face Shelving	31 1/4"	12"	84"	11 1/2"	6			\$ 2,825	
	UN-8412-A-M-30	Single Face Adder	30 1/4"	12"	84"	11 1/2"	6			\$ 2,369	
	UN-8412-S-M-36	Single Face Shelving	37 1/4"	12"	84"	11 1/2"	6			\$ 2,731	
	UN-8412-A-M-36	Single Face Adder	36 1/4"	12"	84"	11 1/2"	6			\$ 2,294	

Model Shown
UN-6012-S-M-36

Model Shown
UN-7212-S-M-36

Model Shown
UN-8412-S-M-36

SHELVING



Model Shown
UN-3624-S-M-36

MODEL NUMBER	PRODUCT	WIDTH	DEPTH	HEIGHT	SHELF DEPTH	# OF SHELVES	# OF OPENINGS	WEIGHT	VOLUME	LIST PRICE
UN-3024-S-M-24	Double Face Shelving	25 1/4"	24"	30"	11 1/2"	4	4			\$ _____
UN-3024-A-M-24	Double Face Adder	24 1/4"	24"	30"	11 1/2"	4	4			\$ _____
UN-3024-S-M-30	Double Face Shelving	31 1/4"	24"	30"	11 1/2"	4	4			\$ _____
UN-3024-A-M-30	Double Face Adder	30 1/4"	24"	30"	11 1/2"	4	4			\$ _____
UN-3024-S-M-36	Double Face Shelving	37 1/4"	24"	30"	11 1/2"	4	4			\$ _____
UN-3024-A-M-36	Double Face Adder	36 1/4"	24"	30"	11 1/2"	4	4			\$ _____
UN-3624-S-M-24	Double Face Shelving	25 1/4"	24"	36"	11 1/2"	4	4			\$ 2,156
UN-3624-A-M-24	Double Face Adder	24 1/4"	24"	36"	11 1/2"	4	4			\$ 1,819
UN-3624-S-M-30	Double Face Shelving	31 1/4"	24"	36"	11 1/2"	4	4			\$ 2,156
UN-3624-A-M-30	Double Face Adder	30 1/4"	24"	36"	11 1/2"	4	4			\$ 1,819
UN-3624-S-M-36	Double Face Shelving	37 1/4"	24"	36"	11 1/2"	4	4			\$ 2,081
UN-3624-A-M-36	Double Face Adder	36 1/4"	24"	36"	11 1/2"	4	4			\$ 1,756

Back frame is made of a double 1" x 1" metal tube, with powder coat finish. End panel is made of 1" thick, 11-ply solid core with grade "A" veneer on two sides. Edge band is 1/4" external hardwood. Comes with adjustable upper shelves and one fixed bottom shelf. Low back metal shelves with a 1 1/4" high book stop. Shelf depths are 9 1/2", 11 1/2" and 14".

Back frame is double 1" x 1" metal tube, with beige powder coat.

Standard pricing is used for natural finishes on Maple or Oak veneer – Add 10% for stained finishes on Maple or Oak veneers.

Add 20% to List pricing for natural finishes on Cherry or Walnut veneer - Add 30% for stained finishes on Cherry or Walnut veneers.



Model Shown
UN-4824-S-M-36

UN-4224-S-M-24	Double Face Shelving	25 1/4"	24"	42"	11 1/2"	6	6			\$ 2,750
UN-4224-A-M-24	Double Face Adder	24 1/4"	24"	42"	11 1/2"	6	6			\$ 2,375
UN-4224-S-M-30	Double Face Shelving	31 1/4"	24"	42"	11 1/2"	6	6			\$ 2,750
UN-4224-A-M-30	Double Face Adder	30 1/4"	24"	42"	11 1/2"	6	6			\$ 2,375
UN-4224-S-M-36	Double Face Shelving	37 1/4"	24"	42"	11 1/2"	6	6			\$ 2,663
UN-4224-A-M-36	Double Face Adder	36 1/4"	24"	42"	11 1/2"	6	6			\$ 2,306
UN-4824-S-M-24	Double Face Shelving	25 1/4"	24"	48"	11 1/2"	6	6			\$ 2,819
UN-4824-A-M-24	Double Face Adder	24 1/4"	24"	48"	11 1/2"	6	6			\$ 2,406
UN-4824-S-M-30	Double Face Shelving	31 1/4"	24"	48"	11 1/2"	6	6			\$ 2,819
UN-4824-A-M-30	Double Face Adder	30 1/4"	24"	48"	11 1/2"	6	6			\$ 2,406
UN-4824-S-M-36	Double Face Shelving	37 1/4"	24"	48"	11 1/2"	6	6			\$ 2,719
UN-4824-A-M-36	Double Face Adder	36 1/4"	24"	48"	11 1/2"	6	6			\$ 2,338

SHELVING

MODEL NUMBER	PRODUCT	WIDTH	DEPTH	HEIGHT	SHELF DEPTH	# OF SHELVES	# OF OPENINGS	WEIGHT	VOLUME	LIST PRICE	DESCRIPTION
--------------	---------	-------	-------	--------	-------------	--------------	---------------	--------	--------	------------	-------------



Model Shown
UN-6024-S-M-36

UN-6024-S-M-24	Double Face Shelving	25 1/4"	24"	60"	11 1/2"	8	8			\$ 3,569	Back frame is made of a double 1" x 1" metal tube, with powder coat finish. End panel is made of 1" thick, 11-ply solid core with grade "A" veneer on two sides. Edge band is 1/4" external hardwood. Comes with adjustable upper shelves and one fixed bottom shelf. Low back metal shelves with a 1 1/4" high book stop. Shelf depths are 9 1/2", 11 1/2" and 14".
UN-6024-A-M-24	Double Face Adder	24 1/4"	24"	60"	11 1/2"	8	8			\$ 3,119	
UN-6024-S-M-30	Double Face Shelving	31 1/4"	24"	60"	11 1/2"	8	8			\$ 3,569	
UN-6024-A-M-30	Double Face Adder	30 1/4"	24"	60"	11 1/2"	8	8			\$ 3,119	
UN-6024-S-M-36	Double Face Shelving	37 1/4"	24"	60"	11 1/2"	8	8			\$ 3,456	
UN-6024-A-M-36	Double Face Adder	36 1/4"	24"	60"	11 1/2"	8	8			\$ 3,031	

Back frame is double 1" x 1" metal tube, with beige powder coat.



Model Shown
UN-7224-S-M-36

UN-7224-S-M-24	Double Face Shelving	25 1/4"	24"	72"	11 1/2"	10	10			\$ 3,881	Standard pricing is used for natural finishes on Maple or Oak veneer – Add 10% for stained finishes on Maple or Oak veneers.
UN-7224-A-M-24	Double Face Adder	24 1/4"	24"	72"	11 1/2"	10	10			\$ 3,381	
UN-7224-S-M-30	Double Face Shelving	31 1/4"	24"	72"	11 1/2"	10	10			\$ 3,881	
UN-7224-A-M-30	Double Face Adder	30 1/4"	24"	72"	11 1/2"	10	10			\$ 3,381	
UN-7224-S-M-36	Double Face Shelving	37 1/4"	24"	72"	11 1/2"	10	10			\$ 3,769	
UN-7224-A-M-36	Double Face Adder	36 1/4"	24"	72"	11 1/2"	10	10			\$ 3,294	



Add 20% to List pricing for natural finishes on Cherry or Walnut veneer - Add 30% for stained finishes on Cherry or Walnut veneers.









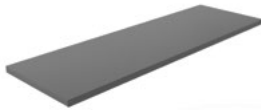

Model Shown
UN-8424-S-M-36





UN-8424-S-M-24	Double Face Shelving	25 1/4"	24"	84"	11 1/2"	12	12			\$ 4,450	
UN-8424-A-M-24	Double Face Adder	24 1/4"	24"	84"	11 1/2"	12	12			\$ 3,894	
UN-8424-S-M-30	Double Face Shelving	31 1/4"	24"	84"	11 1/2"	12	12			\$ 4,450	
UN-8424-A-M-30	Double Face Adder	30 1/4"	24"	84"	11 1/2"	12	12			\$ 3,894	
UN-8424-S-M-36	Double Face Shelving	37 1/4"	24"	84"	11 1/2"	12	12			\$ 4,319	
UN-8424-A-M-36	Double Face Adder	36 1/4"	24"	84"	11 1/2"	12	12			\$ 3,800	



SHELVING



	MODEL NUMBER	PRODUCT	WIDTH	DEPTH	HEIGHT	WEIGHT	VOLUME	LIST PRICE	DESCRIPTION
 <p>Model Shown UN-SL12-36</p>	SL10-24	Slotted Metal Shelf	23 1/4"	9 1/2"	5"			\$ 194	Divider shelf is 5" high with 3 metal dividers. Shelf is slotted at 2" intervals.
	SL12-24		23 1/4"	11 1/2"	5"			\$ 194	
	SL10-30		29 1/4"	9 1/2"	5"			\$ 194	
	SL12-30		29 1/4"	11 1/2"	5"			\$ 194	
	SL10-36		35 1/4"	9 1/2"	5"			\$ 206	
	SL12-36		35 1/4"	11 1/2"	5"			\$ 206	
 <p>Model Shown UN-LB12-36</p>	M-LB10-24	Low Back Metal Shelf	23 1/4"	9 1/2"				\$ 81	Metal shelf with a 1 1/4" high book stop back edge.
	M-LB12-24		23 1/4"	11 1/2"				\$ 81	
	M-LB14-24		23 1/4"	14"				\$ 88	
	M-LB10-30		29 1/4"	9 1/2"				\$ 81	
	M-LB12-30		29 1/4"	11 1/2"				\$ 81	
	M-LB14-30		29 1/4"	14"				\$ 88	
	M-LB10-36		35 1/4"	9 1/2"				\$ 88	
	M-LB12-36		35 1/4"	11 1/2"				\$ 88	
	M-LB14-36		35 1/4"	14"				\$ 94	
 <p>Model Shown UN-F12-36</p>	M-F10-24	Flat Metal Shelf	23 1/4"	9 1/2"	6"			\$ 63	Metal shelf with no book stop back edge.
	M-F12-24		23 1/4"	11 1/2"	6"			\$ 69	
	M-F14-24		23 1/4"	14"	6"			\$ 75	
	M-F10-30		29 1/4"	9 1/2"	6"			\$ 63	
	M-F12-30		29 1/4"	11 1/2"	6"			\$ 69	
	M-F14-30		29 1/4"	14"	6"			\$ 75	
	M-F10-36		35 1/4"	9 1/2"	6"			\$ 69	
	M-F12-36		35 1/4"	11 1/2"	6"			\$ 75	
	M-F14-36		35 1/4"	14"	6"			\$ 81	

	MODEL NUMBER	PRODUCT	WIDTH	DEPTH	HEIGHT	WEIGHT	VOLUME	LIST PRICE	DESCRIPTION	
 Model Shown UN-V12-36	G10-24	Glass Shelf	23 1/4"	9 1/2"	6"			\$ 131		
	G12-24		23 1/4"	11 1/2"	6"			\$ 131		
	G14-24		23 1/4"	14"	6"			\$ 131		
		G10-30		29 1/4"	9 1/2"	6"			\$ 138	
		G12-30		29 1/4"	11 1/2"	6"			\$ 138	
		G14-30		29 1/4"	14"	6"			\$ 138	
		G10-36		35 1/4"	9 1/2"	6"			\$ 144	
		G12-36		35 1/4"	11 1/2"	6"			\$ 144	
		G14-36		35 1/4"	14"	6"			\$ 144	
 Model Shown UN-ME12-36	M-ME12-24	Metal Media Shelf	23 1/4"	4 3/4"	12"	15 Lbs.	1 Cu Ft	\$ 256	18 gauge cold rolled steel with flanges. Front of shelf bent to 90 degrees, 4" high above the shelf. Back flange forms a triple bend End flanges notched to accept 3/16" galvanized shelf support pin. "	
	M-ME12-30		29 1/4"	4 3/4"	12"			\$ 256		
	M-ME12-36		35 1/4"	4 3/4"	12"			\$ 263		
 Model Shown UN-M12-36	M-M12-24	Hinged Magazine Shelf	23 1/4"		12"			\$ 156	Hinged metal magazine shelf with 12" height and 1" deep x 3/4" high lip.	
	M-M12-30		29 1/4"		12"			\$ 156		
	M-M12-36		35 1/4"		12"			\$ 144		
 Model Shown UN-SL12-36	M-SL12-24	Metal Picture Book Shelf						\$ 231		
	M-SL12-30							\$ 231		
	M-SL12-36							\$ 238		

	MODEL NUMBER	PRODUCT	WIDTH	DEPTH	HEIGHT	WEIGHT	VOLUME	LIST PRICE	DESCRIPTION
	M-GSB	Bottom Metal Grooved Shelf Option						\$ 44	Grooved Metal shelf to accept pendant dividers upcharge. Notes: Each Shelf comes with one Pendant Divider. Additional Pendants can be ordered separately.
	PD-01	Wire Pendant Divider						\$ 19	Wire Pendant Divider, chrome finish.
	M-SL-D10	Divider	9 1/2"		5"			\$ 38	Metal Dividers for divider shelf are 5" high and come in depths of 9 1/2" and 11 1/2".
	M-SL-D12		11 1/2"		5"			\$ 44	
 Model Shown UN-SL-D12	WBS-01	Wire Book Support - For Low Back Shelf						\$ 25	Chrome Clip-on wire book support for low back shelves.
 Model Shown UN-BE6	M-BE6	Metal Book End						\$ 19	Metal book end stop with rubber bottoms.
	M-BE9							\$ 25	

	MODEL NUMBER	PRODUCT	WIDTH	DEPTH	HEIGHT	WEIGHT	VOLUME	LIST PRICE	DESCRIPTION	
 <p>Model Shown UN-KP36</p>	UN-KP24	24" Kickplate	24"		2"			\$ 19	Metal 2 1/2" high kickplate installs with two drop-in pins and comes in sizes of 24", 30", and 36" wide.	
	UN-KP30	30" Kickplate	30"		2"			\$ 25		
	UN-KP36	36" Kickplate	36"		2"			\$ 25		
 <p>Model Shown UN-BF-SF-36</p>	UN-BF-A-24	Metal Back Frame "A"	23 1/4"		32"-48" Units			\$ 138	Made of 1" x 1" metal tube with beige powder coat. "A" frame for shelving units: 32", 42", 48" high. "B" frame for shelving units: 60", 72", 84", 96" high.	
	UN-BF-B-24	Metal Back Frame "B"	23 1/4"		60"-96" Units			\$ 275		
	UN-BF-A-30	Metal Back Frame "A"	29 1/4"		32"-48" Units			\$ 144		
	UN-BF-B-30	Metal Back Frame "B"	29 1/4"		60"-96" Units			\$ 281		
	UN-BF-A-36	Metal Back Frame "A"	35 1/4"		32"-48" Units			\$ 144		
	UN-BF-B-36	Metal Back Frame "B"	35 1/4"		60"-96" Units			\$ 281		
 <p>Model Shown UN-BAT1236</p>	UN-BAT1024	Single File Top Shelf	23 1/4"	10"	1"			\$ 175	Top is 1" thick, 11-ply solid core with grade "A" veneers on two sides. Edge band is 1/4" external solid hardwood.	
	UN-BAT1224		23 1/4"	12"	1"			\$ 175		
	UN-BAT1424		23 1/4"	14"	1"			\$ 175		
	UN-BAT1030	Single File Top Shelf	29 1/4"	10"	1"			\$ 175	Standard pricing is used for natural finishes on Maple or Oak veneer – Add 10% for stained finishes on Maple or Oak veneers.	
	UN-BAT1230		29 1/4"	12"	1"			\$ 175		
	UN-BAT1430		29 1/4"	14"	1"			\$ 175		
	UN-BAT1036	Single File Top Shelf	35 1/4"	10"	1"			\$ 175	Add 20% to List pricing for natural finishes on Cherry or Walnut veneer - Add 30% for stained finishes on Cherry or Walnut veneers.	
	UN-BAT1236		35 1/4"	12"	1"			\$ 175		
	UN-BAT1436		35 1/4"	14"	1"			\$ 175		
	 <p>Model Shown UN-BAT2436</p>	UN-BAT2024	Double File Top Shelf	23 1/4"	20"	1"			\$ 231	
		UN-BAT2424		23 1/4"	24"	1"			\$ 231	
		UN-BAT2824		23 1/4"	28"	1"			\$ 231	
UN-BAT2030		Double File Top Shelf	29 1/4"	20"	1"			\$ 231		
UN-BAT2430			29 1/4"	24"	1"			\$ 231		
UN-BAT2830			29 1/4"	28"	1"			\$ 231		
UN-BAT2036		Double File Top Shelf	35 1/4"	20"	1"			\$ 231		
UN-BAT2436			35 1/4"	24"	1"			\$ 231		
UN-BAT2836			35 1/4"	28"	1"			\$ 231		

MODEL NUMBER	PRODUCT	WIDTH	DEPTH	HEIGHT	WEIGHT	VOLUME	LIST PRICE	DESCRIPTION
 <p>Model Shown UN-BA7212E</p>	Single Face Bolt Assembly End Panels		10	36			\$ 250	Made of 1' thick, 1 1-ply solid core with grade "A" veneer on two sides. Edge band is 1/4" external hardwood. Has adjustable levelers that allow for adjustments in 1 1/4" increments.
			10	42			\$ 281	
			10	48			\$ 300	
			10	60			\$ 338	
			10	72			\$ 375	
			10	84			\$ 413	
			10	96			\$ 406	
			12	36			\$ 263	
			12	42			\$ 288	
			12	48			\$ 313	
	12	60			\$ 344			
	12	72			\$ 381			
	12	84			\$ 419			
	12	96			\$ 463			
	14	36			\$ 269			
	14	42			\$ 300			
	14	48			\$ 319			
	14	60			\$ 356			
	14	72			\$ 394			
	14	84			\$ 431			
	14	96			\$ 475			
 <p>Model Shown UN-BA7212M</p>	Single Face Bolt Assembly Mid Panels		10	36			\$ 263	Made of 1' thick, 1 1-ply solid core with grade "A" veneer on two sides. Edge band is 1/4" external hardwood. Has adjustable levelers that allow for adjustments in 1 1/4" increments.
			10	42			\$ 294	
			10	48			\$ 319	
			10	60			\$ 356	
			10	72			\$ 394	
			10	84			\$ 431	
			10	96			\$ 425	
			12	36			\$ 275	
			12	42			\$ 300	
			12	48			\$ 325	
	12	60			\$ 363			
	12	72			\$ 400			
	12	84			\$ 438			
	12	96			\$ 481			
	14	36			\$ 281			
	14	42			\$ 313			
	14	48			\$ 338			
	14	60			\$ 375			
	14	72			\$ 413			
	14	84			\$ 456			
	14	96			\$ 500			

MODEL NUMBER	PRODUCT	WIDTH	DEPTH	HEIGHT	WEIGHT	VOLUME	LIST PRICE	DESCRIPTION	
 <p>Model Shown UN-BA7224E</p>	Double Face Bolt Assembly End Panels			UN-BA3620E	20	36	\$ 300	Made of 1' thick, 1 1-ply solid core with grade "A" veneer on two sides. Edge band is 1/4" external hardwood. Has adjustable levelers that allow for adjustments in 1 1/4" increments.	
				UN-BA4220E	20	42	\$ 338		
				UN-BA4820E	20	48	\$ 363		
				UN-BA6020E	20	60	\$ 400		
				UN-BA7220E	20	72	\$ 450		
				UN-BA8420E	20	84	\$ 500		
				UN-BA9620E	20	96	\$ 544		
				UN-BA3624E	24	36	\$ 313		
				UN-BA4224E	24	42	\$ 344		
				UN-BA4824E	24	48	\$ 375		
UN-BA6024E	24	60	\$ 413						
UN-BA7224E	24	72	\$ 456						
UN-BA8424E	24	84	\$ 506						
UN-BA9624E	24	96	\$ 556						
 <p>Model Shown UN-BA7224M</p>	Double Face Bolt Assembly Mid Panels			UN-BA3628E	28	36	\$ 319	Made of 1' thick, 1 1-ply solid core with grade "A" veneer on two sides. Edge band is 1/4" external hardwood. Has adjustable levelers that allow for adjustments in 1 1/4" increments.	
				UN-BA4228E	28	42	\$ 356		
				UN-BA4828E	28	48	\$ 381		
				UN-BA6028E	28	60	\$ 419		
				UN-BA7228E	28	72	\$ 469		
				UN-BA8428E	28	84	\$ 519		
				UN-BA9628E	28	96	\$ 563		
				UN-BA3620M	20	36	\$ 319		Standard pricing is used for natural finishes on Maple or Oak veneer – Add 10% for stained finishes on Maple or Oak veneers.
				UN-BA4220M	20	42	\$ 356		
				UN-BA4820M	20	48	\$ 381		
UN-BA6020M	20	60	\$ 419						
UN-BA7220M	20	72	\$ 469						
UN-BA8420M	20	84	\$ 519						
UN-BA9620M	20	96	\$ 575						
UN-BA3624M	24	36	\$ 325	Add 20% to List pricing for natural finishes on Cherry or Walnut veneer - Add 30% for stained finishes on Cherry or Walnut veneers.					
UN-BA4224M	24	42	\$ 363						
UN-BA4824M	24	48	\$ 394						
UN-BA6024M	24	60	\$ 431						
UN-BA7224M	24	72	\$ 475						
UN-BA8424M	24	84	\$ 531						
UN-BA9624M	24	96	\$ 581						
UN-BA3628M	28	36	\$ 338						
UN-BA4228M	28	42	\$ 375						
UN-BA4828M	28	48	\$ 400						
UN-BA6028M	28	60	\$ 438						
UN-BA7228M	28	72	\$ 494						
UN-BA8428M	28	84	\$ 538						
UN-BA9628M	28	96	\$ 594						

Palmieri Furniture Limited ("Palmieri") warrants that its products and collections are free from defects in materials and workmanship for the life of the product, except as set forth below. Palmieri Limited Lifetime Warranty is valid from the date of delivery.

Exceptions to the Limited Lifetime Warranty: Seating: two (2) years

Goods sold hereunder are covered by a Limited Lifetime Warranty, free against defects in material and workmanship provided the goods and services are subjected to normal use and service. The applicable warranty period commences from shipping date to Purchaser of any item of the goods, whichever occurs first, or any other warranty period otherwise stipulated in writing by Palmieri under this sale. For components not supplied by Palmieri, the original manufacturer's warranty shall apply to the extent assignable by Palmieri. The obligation under this warranty is limited to the repair or replacement, at Palmieri's option, of defective parts F.O.B. point of shipment provided that prompt notice of any defect is given by Purchaser to Palmieri in writing within the applicable warranty period and that upon the Purchaser's return of the defective parts to Palmieri or, if designated by Palmieri, to the location where the works are made, properly packed and with transportation charges prepaid by Purchaser, an inspection thereof shall reveal to Palmieri's satisfaction that Purchaser's claim is valid under the terms of this warranty. Purchaser shall assume all responsibility and expense for dismantling, removal, re-installation and freight in connection with the foregoing. The same obligations and conditions extend to replacement parts furnished by Palmieri hereunder.

Palmieri does not assume liability for installation, labour or consequential damages. Palmieri makes no warranty other than the one set forth herein. All other warranties, legal, expressed or implied, including but not limited to any expressed or implied warranty of merchantability, of fitness for the intended use thereof or against infringement are hereby expressly excluded. The applicable warranty ceases to be effective if the goods are altered or repaired other than by persons authorized or approved by Palmieri to perform such work. Repairs or replacement deliveries do not interrupt or prolong the term of the warranty. The warranty ceases to be effective if Purchaser fails to handle and use the goods sold hereunder in a safe and reasonable manner and in accordance with any written instructions from the manufacturers.

Warranty Does Not Apply To Product Failure Or Loss Resulting From:

Abuse, misuse or accident, alteration or modification of product by customer or third party, normal wear and tear, improper installation, handling or incorrect use. The substitution of part components or hardware not approved or authorized by Palmieri, acts of God, unauthorized repairs, improper storage, and environmental conditions such as irregular temperature control either inside or outside the environment.

Warranty Provides Exclusive Remedies:

If a product fails under ordinary use as a result of a defect in material or workmanship, Palmieri will: (A) repair, or (B) replace the furniture. The replacement or repair of the Furniture or Seating will be at the discretion of Palmieri. If the defect or workmanship cannot be remedied on site, repairs can be made at the factory. (C) If the product repair or replacement is not commercially practicable or cannot be remade in a timely manner Palmieri will refund the purchase price of the affected product. A product "**Defect**" means: an inadequacy in the materials or workmanship of the product that (A) existed at the time when you received the product from Palmieri or Palmieri authorized Reseller and (B) causes a failure of the product to perform under ordinary use in accordance with the materials and documentation accompanying the product. "**Ordinary Use**" means: use of the product (A) in accordance with all applicable local, state or federal laws, codes and regulations and (B) in accordance with manufacturer recommendations and or instructions in the materials and documentation accompanying the product or through shop drawings. A "**Palmieri Authorized Reseller**" means: any dealer that is legally permitted to conduct business in the jurisdiction where the product is sold and is duly authorized by Palmieri to sell the product.

Warranty work must be approved by authorized personnel of Palmieri Furniture Limited in Richmond Hill, Ontario, Canada.

A copy of the original purchase order must accompany all claims.

Warranty Does Not Cover:

Matching of colours, stains, textures, grains and any other variations in materials. Select and Custom Surfaces and materials are only warranted for their application on the specified product and are not covered by our warranty, except as warranted by the original supplier, for quality, colorfastness, shade variations or abrasion and textiles purchased for Palmieri product.

This limited warranty is the sole remedy for product defect and no other express or implied warranty is provided. Warranty is not transferable and valid only for the original purchaser acquiring a product from Palmieri or a Palmieri authorized reseller for the purchaser's own use and not for resale, remarketing or distribution. Limited Lifetime Warranty (25 years)

GENERAL

The following Terms and Conditions of Quote and Sale shall apply to any sale of goods and services by Palmieri Furniture Limited (hereinafter called "Palmieri"). Purchaser shall be deemed to have full knowledge of the terms and conditions herein and such terms and conditions shall be binding if either the goods and services referred to herein are delivered to and accepted by Purchaser, or if Purchaser does not within five (5) days from the date hereof deliver to Palmieri written objection to said terms and conditions or any part thereof.

In the event of any conflict or inconsistency between the terms and conditions of sale herein and the terms and conditions contained in Purchaser's order or in any other form issued by Purchaser, whether or not any such form has been acknowledged or accepted by Palmieri, Palmieri's terms and conditions herein shall prevail. No waiver, alteration or modification of these terms and conditions shall be binding upon Palmieri unless made in writing and signed by a duly authorized representative of Palmieri.

1. QUOTATIONS / PRODUCT QUOTED

Unless otherwise stated, **Palmieri's quotations shall be null and void unless accepted by Purchaser within thirty (30) days from the date of quotation.** Quotes may be subject to change before order placement, due to increased material costs and or other factors that could impact the final cost of production and our final understanding of the product required. If the items quoted do not reflect the intended product requirements of the customer, Palmieri will not be held responsible for increased costs for those product changes. We reserve the right to edit or re-quote any portion of a previously submitted quotation subject to our final understanding of the product required by the client.

2. PALMIERI DRAWINGS

Palmieri provides drawings for Custom & Standard product we produce to our clients upon request. We consider these drawings to be Private and Confidential and are provided for the sole purpose and use of our clients to understand the product we are providing. The use of these confidential materials is limited to the transaction between the parties and at no point are these confidential materials to be sent to any of our competitors or parties quoting for the same purpose.

A minimum \$85.00 NET Engineering Administrative Fee will apply for Custom Product Drawings

(Note: The first set of Custom product drawings will be free of charge)

A minimum \$120.00 NET Engineering Administrative Fee will apply for all Standard Product Drawings

3. TERMS OF PAYMENT

For authorized customers; Orders at a \$75,000.00 threshold will require a mandatory 25% deposit. Orders over and above \$100,000.00 requires a mandatory (25%) deposit at time of order, a mandatory (25%) deposit prior to product shipment and the balance to be paid within thirty (30) days of date of shipment. Payment not be made to Palmieri when due, Palmieri reserves the right to charge Purchaser with interest on such overdue payments. Interest of 2% per month (24% per annum) is charged on all overdue accounts, unless otherwise specified. The charging of such interest shall not be construed as obligating Palmieri to grant any extension of time in the terms of payment. All goods remain the property of Palmieri, until balance is paid in full to Palmieri.

4. TITLE

Title to the goods or any part thereof shall not pass from Palmieri to Purchaser until all payments due hereunder have been duly made, except as otherwise expressly stipulated herein. The goods shall be and remain personal or moveable property, notwithstanding their mode of attachment to realty or other property. If default is made in any of the payments herein, Purchaser agrees that Palmieri may retain all payments which have been made on account of the purchase price as liquidated damages, and Palmieri shall be free to enter the premises where the goods may be located and remove them as Palmieri's property, without prejudice to Palmieri's right to recover any further expenses or damages Palmieri may suffer by reason of such nonpayment.

5. TAXES

Prices do not include Goods & Services Tax, Provincial or Municipal sales, use, value-added or similar tax. All applicable taxes are extra. Our Harmonized Sales Tax (HST) registration number is R104055066.

6. THE AGREEMENT

An acceptance and official confirmation of Purchasers' order by signing Palmieri's Order Confirmation the Purchaser therefore is accepting terms and conditions as expressed herein Palmieri's Terms and Conditions of Quote and Sale by Palmieri and shall constitute the complete agreement, subject to the terms and conditions of sale herein set forth, and shall supersede all previous quotations, orders or agreements.

7. LEAD TIME / DELIVERY / DELAYS

Lead time is determined only when final material/finish selection and drawing approvals are received by Palmieri from the client. The accuracy of Palmieri's lead times, is created to the best of our ability with the information provided to us. Confirmed lead time is conveyed to the client by means of Order Confirmation. They do not preclude the client from checking the accuracy of your requirement and our Order Confirmation. Any noted discrepancies are to be reported immediately to Palmieri Customer Service Department for correction and re-issue of revised Order Confirmation. By signing and dating the Order Confirmation the client accepts the terms and conditions of quote and sale.

Lead time on our Order Confirmation do not account for delays that could potentially occur for special materials specified by the client that are outside of our standard finishes and materials program that are out of our control

and will affect the lead time on the order. Palmieri will notify the client immediately when these delays occur and adjust the lead time accordingly.

Delivery schedules are approximate and are based on prevailing market conditions applicable respectively at the time of Palmieri's quotation and Palmieri's acceptance of clients' order, if certain portions of an order are completed by the quoted lead time while other portions have experienced delays outside of our control. The client may choose to part ship the order at their discretion and expense. Otherwise the entire order will ship with the delayed portion at a later date. Palmieri may extend delivery schedules or may, at its option, cancel Purchaser's order in full or in part without liability other than to return any deposit or prepayment which is unearned by reason of the cancellation.

8. CHANGES AND CANCELLATION

Orders accepted by Palmieri are not subject to changes or cancellation by Purchaser without the written consent of Palmieri. In such cases where Palmieri authorizes changes or cancellation, Palmieri reserves the right to charge the Purchaser with reasonable costs based upon expenses already incurred and commitments made by Palmieri, including, without limitation, any labour done, material purchased and also including Supplier's usual overhead and reasonable profit and cancellation charges from Palmieri's suppliers. Palmieri will communicate to the Purchaser additional costs incurred by way of Revised Order Confirmation. Revised Order Confirmation will include applicable costs incurred and modification to lead times (if applicable). The Purchaser must provide Palmieri written confirmation of additional costs, before any changes can be processed on the order.

A minimum charge of \$100.00 NET Change Order Request fee will apply

A minimum charge of \$150.00 NET Cancel Order Request fee will apply.

9. SHIPPING LOCATION / SHIPPING QUOTES / COST OF TRANSPORTATION

Unless otherwise stated, all prices are F.O.B. our factory in Richmond Hill, Ontario, Canada.

Customary methods of transportation shall be selected by Palmieri and such transportation will be at Purchaser's expense. Shipping quotations are made at time of furniture quotation and are outside the control of Palmieri. **Shipping quotes are valid for ten (10) business days from the time of quote.** We do our best to maintain shipping costs as quoted, however all shipping weights and cubic feet shown are approximate only, various construction materials and packaging methods may add to the weights given. All quoted prices, unless otherwise stated on the quotation, are based on the current exchange rates, tariffs, fuel surcharges and costs of manufacture and are subject to change by Palmieri with or without notice until Purchaser's acceptance. Palmieri does not assume responsibility or liability for shipping costs, product during transit, or variances from the shipping weights or cubic feet shown in our specification guides. Special methods of transportation will be used upon Purchaser's request and at Purchaser's additional expense, provided reasonable notice of Purchaser's transportation requirements are given by Purchaser to Palmieri prior to shipment. Palmieri will notify the client prior to shipping product if shipping costs as quoted change, at which point the client must approve the adjusted shipping costs.

10. RECEIVING PRODUCT / REPORTING DAMAGE / STORAGE OF PRODUCT

Upon receipt of Palmieri product, the receiver of the goods must immediately inspect the product to ensure it is free of shipping damage. If the product is deemed in good order, the receiver of the product must ensure

to sign off on the accompanying carriers Bill of lading in good condition. Except for obligations stated under "Warranty" herein, Palmieri's responsibility for the product ceases once the product has been received and signed off in good order and is the full responsibility of the receiver and subsequently the owner.

In the event shipping damage is discovered during receipt of shipment, it is the responsibility of the receiver to ensure all noted damage is recorded on the carrier's Bill of Lading prior to sign off. All noted shipping damage claims must be reported to Palmieri within **24 hours** of receipt of the product onsite, failure to do so will result in the claim being deemed null and void. All shipping damage claims are to be reported directly to Palmieri's Shipping Manager. Please call our toll free number at **1-800-413-4440 ext. 33** or submit the claim by Fax directly to **1-905-731-9878**. Palmieri will not accept any shipping damage claims submitted **after 24 hours** and it shall be conclusively presumed that the goods were delivered in good condition.

Storage of product, Palmieri will not be held responsible for any potential damages or shortages for product shipped and received by Purchaser and is subsequently placed into storage and not inspected within 24 hours of receipt.

11. INSTALLATION / SHORTAGES / BACK CHARGES

Unless otherwise expressly stipulated, the goods shall be installed by and at the risk and expense of Purchaser.

In the event that Palmieri is requested to supervise such installation, Palmieri's responsibility shall be limited to exercising that degree of skill customary in the trade in supervising installations of the same type. Purchaser shall remain responsible for all other aspects of the work including compliance with the local regulations. It is the responsibility of the Purchaser to ensure hardware and parts are received in good order. Packing slip and hardware list to be provided by Palmieri with every order at time of shipping. Purchaser has the responsibility to notify Palmieri immediately without delay of issues that arise; subsequently Palmieri will take action to provide prompt resolution.

Shortages must be reported to Palmieri within **24 hours** of receipt of the goods and failure to do so may be at the expense of the Purchaser.

If deemed missing hardware and parts short shipped from the factory, Palmieri will arrange to ship freight prepaid to destination. Palmieri will only be responsible for replacement costs of missing hardware and parts, any labour costs incurred will be the responsibility of the Purchaser and will not be approved by Palmieri.

Back Charges will only be approved if we deemed a defect in the material or workmanship is found during the installation period resulting in a return trip to the job-site to complete installation. It shall remain the sole discretion of Palmieri to approve (A) repair or (B) replace the furniture and any labour costs incurred by the Purchaser.

12. FORCE MAJEURE

Palmieri shall not be responsible or liable for any loss or damage incurred by Purchaser herein resulting from causes beyond the reasonable control of Palmieri including, but without limitation, abuse, misuse or accident, alteration or modification of product by customer or third party, normal wear and tear, improper installation, handling or incorrect use, unauthorized repairs, the substitution of part components or hardware not approved or authorized by Palmieri, improper storage, and environmental conditions such as irregular temperature control

either inside or outside the environment, acts of God, fire, flood, delays in transportation, or the failure of Palmieri's suppliers to meet their delivery promises. The acceptance of delivery of the goods by Purchaser shall constitute a waiver of all claims for loss or damage due to any delay whatsoever.

13. RETURNED GOODS

No goods may be returned to Palmieri for a credit or exchanged without Palmieri's prior written consent.

Palmieri reserves the right to accept all returns and subject to a handling/restocking charge or to decline all returns. Even after Palmieri has authorized the return of goods for credit, Palmieri reserves the right to adjust the amount of any credit given to Purchaser on return of the goods based on the conditions of the goods on arrival in Palmieri's warehouse. Credit for returned goods will be issued to Purchaser only where such goods are returned by Purchaser and not by any subsequent owner of the goods. Goods will be considered for return only if they are in their original condition and packaging. Palmieri Goods Return Authorization Form to be issued and **must** accompany all shipments returning back to the factory. **Return freight must be prepaid by Purchaser. A minimum 20% re-stocking fee will apply.**

1230 Reid Street
Richmond Hill
Ontario Canada
L4B 1C4

T 905 731 9300
F 905 731 9878
TF 800 413 4440
info@palmierifurniture.com
www.PalmieriFurniture.com









SPECIFICATION GUIDE & PRICE LIST

2017

PALMIER

SHELVING
VENUE METAL

CATEGORY: LIBRARY FURNITURE
CONTRACT: BID #ESCNJ 17/18-16

Introduction	1	Components & Accessories	34-39
Table of Contents	2-3	 Shelves	34-35
Product Materials & Finishes	4-5	 Divider, Wire Book Support	36-37
Venue Shelving	6-29	 Metal Book End, Cross Bars, Kickplate, Canopy Brackets	38-39
 Single Face Shelving	6-13	Panels	40-47
 Double Face Shelving	14-21	 Single Face Panels	40-41
 Single Face Magazine Shelving	22-27	 Double Face Panels	42-43
 Double Face Magazine Shelving	28-34	Warranty	44
		Terms & Conditions	45

SHELVING

METAL PAINT:

Thermal Paint Colours



White
PS-111-W374



Antique White
W11

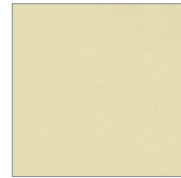

Beige
H23

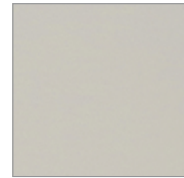

Desert
H432



Red
R66



Ruby
R7



Blue
B11



Navy
B17

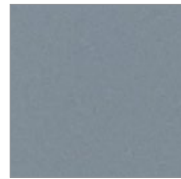

Zinc
A67



Hydro Green
G96



Green
G58



Grey
A16



Charcoal
A230



Black
N49



Pebble
M237

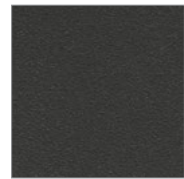

Black Sandtex
N31



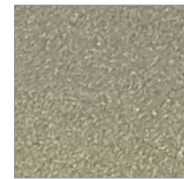

Sparkling Silver
S11







Champagne
S14

METAL FINISHING PROCEDURES: All metal components are thoroughly cleaned and coated electrostatically with an epoxy powder coat paint finish. The metal components are then oven baked and cured for a lasting finish.

	MODEL NUMBER	PRODUCT	WIDTH	DEPTH	HEIGHT	SHELF DEPTH	# OF SHELVES	# OF OPENINGS	WEIGHT	VOLUME	LIST PRICE	DESCRIPTION
 <p>Model Shown VE-4812-S-36</p>	VE-4210-S-24	Single Face Shelving	26 ¹ / ₄ "	12 ¹ / ₄ "	42 ¹ / ₂ "	9 ¹ / ₂ "	3	3			\$ 1,256	<p>End & Intermediate Panels: Panel frame construction consists of 1-1/4" x 1-1/4", 16 gauge steel tube framed on all four sides and an extra vertical tube at the front edge creating a double bar open framed concept. Metal Low Back shelves adjust on 1" increments. All metal parts and components are finished in a powder epoxy, thermal enamel finish.</p> <p>Acrylic screen Insert Option: Frosted acrylic is 1/4" thick positioned in the open frame portion of End Panels. Images shown are to demonstrate the finished product with the acrylic screen insert option and are not the standard product. Please inquire with Palmieri for pricing.</p>
	VE-4210-A-24	Single Face Adder	25"	12 ¹ / ₄ "	42 ¹ / ₂ "	9 ¹ / ₂ "	3	3			\$ 856	
	VE-4212-S-24	Single Face Shelving	26 ¹ / ₄ "	14 ¹ / ₄ "	42 ¹ / ₂ "	11 ¹ / ₂ "	3	3			\$ 1,319	
	VE-4212-A-24	Single Face Adder	25"	14 ¹ / ₄ "	42 ¹ / ₂ "	11 ¹ / ₂ "	3	3			\$ 906	
	VE-4214-S-24	Single Face Shelving	26 ¹ / ₄ "	16 ³ / ₄ "	42 ¹ / ₂ "	14"	3	3			\$ 1,388	
	VE-4214-A-24	Single Face Adder	25"	16 ³ / ₄ "	42 ¹ / ₂ "	14"	3	3			\$ 944	
 <p>Model Shown VE-4812-A-36</p>	VE-4210-S-30	Single Face Shelving	32 ¹ / ₄ "	12 ¹ / ₄ "	42 ¹ / ₂ "	9 ¹ / ₂ "	3	3			\$ 1,256	
	VE-4210-A-30	Single Face Adder	31"	12 ¹ / ₄ "	42 ¹ / ₂ "	9 ¹ / ₂ "	3	3			\$ 856	
	VE-4212-S-30	Single Face Shelving	32 ¹ / ₄ "	14 ¹ / ₄ "	42 ¹ / ₂ "	11 ¹ / ₂ "	3	3			\$ 1,319	
	VE-4212-A-30	Single Face Adder	31"	14 ¹ / ₄ "	42 ¹ / ₂ "	11 ¹ / ₂ "	3	3			\$ 906	
	VE-4214-S-30	Single Face Shelving	32 ¹ / ₄ "	16 ³ / ₄ "	42 ¹ / ₂ "	14"	3	3			\$ 1,388	
	VE-4214-A-30	Single Face Adder	31"	16 ³ / ₄ "	42 ¹ / ₂ "	14"	3	3			\$ 944	
 <p>Model Shown VE-4812-S-36</p>	VE-4210-S-36	Single Face Shelving	38 ¹ / ₄ "	12 ¹ / ₄ "	42 ¹ / ₂ "	9 ¹ / ₂ "	3	3			\$ 1,256	
	VE-4210-A-36	Single Face Adder	37"	12 ¹ / ₄ "	42 ¹ / ₂ "	9 ¹ / ₂ "	3	3			\$ 856	
	VE-4212-S-36	Single Face Shelving	38 ¹ / ₄ "	14 ¹ / ₄ "	42 ¹ / ₂ "	11 ¹ / ₂ "	3	3			\$ 1,319	
	VE-4212-A-36	Single Face Adder	37"	14 ¹ / ₄ "	42 ¹ / ₂ "	11 ¹ / ₂ "	3	3			\$ 906	
	VE-4214-S-36	Single Face Shelving	38 ¹ / ₄ "	16 ³ / ₄ "	42 ¹ / ₂ "	14"	3	3			\$ 1,388	
	VE-4214-A-36	Single Face Adder	37"	16 ³ / ₄ "	42 ¹ / ₂ "	14"	3	3			\$ 944	

SHELVING

	MODEL NUMBER	PRODUCT	WIDTH	DEPTH	HEIGHT	SHELF DEPTH	# OF SHELVES	# OF OPENINGS	WEIGHT	VOLUME	LIST PRICE	DESCRIPTION
	VE-4810-S-24	Single Face Shelving	26 1/4"	12 1/4"	48 1/2"	9 1/2"	3	3			\$ 1,300	End & Intermediate Panels: Panel frame construction consists of 1-1/4" x 1-1/4", 16 gauge steel tube framed on all four sides and an extra vertical tube at the front edge creating a double bar open framed concept. Metal Low Back shelves adjust on 1" increments. All metal parts and components are finished in a powder epoxy, thermal enamel finish. Acrylic screen Insert Option: Frosted acrylic is 1/4" thick positioned in the open frame portion of End Panels. Images shown are to demonstrate the finished product with the acrylic screen insert option and are not the standard product. Please inquire with Palmieri for pricing.
	VE-4810-A-24	Single Face Adder	25"	12 1/4"	48 1/2"	9 1/2"	3	3			\$ 881	
	VE-4812-S-24	Single Face Shelving	26 1/4"	14 1/4"	48 1/2"	11 1/2"	3	3			\$ 1,369	
	VE-4812-A-24	Single Face Adder	25"	14 1/4"	48 1/2"	11 1/2"	3	3			\$ 925	
	VE-4814-S-24	Single Face Shelving	26 1/4"	16 3/4"	48 1/2"	14"	3	3			\$ 1,438	
	VE-4814-A-24	Single Face Adder	25"	16 3/4"	48 1/2"	14"	3	3			\$ 969	
Model Shown VE-4812-S-36	VE-4810-S-30	Single Face Shelving	32 1/4"	12 1/4"	48 1/2"	9 1/2"	3	3			\$ 1,300	
	VE-4810-A-30	Single Face Adder	31"	12 1/4"	48 1/2"	9 1/2"	3	3			\$ 881	
	VE-4812-S-30	Single Face Shelving	32 1/4"	14 1/4"	48 1/2"	11 1/2"	3	3			\$ 1,369	
	VE-4812-A-30	Single Face Adder	31"	14 1/4"	48 1/2"	11 1/2"	3	3			\$ 925	
	VE-4814-S-30	Single Face Shelving	32 1/4"	16 3/4"	48 1/2"	14"	3	3			\$ 1,438	
	VE-4814-A-30	Single Face Adder	31"	16 3/4"	48 1/2"	14"	3	3			\$ 969	
	VE-4810-S-36	Single Face Shelving	38 1/4"	12 1/4"	48 1/2"	9 1/2"	3	3			\$ 1,300	
	VE-4810-A-36	Single Face Adder	37"	12 1/4"	48 1/2"	9 1/2"	3	3			\$ 881	
	VE-4812-S-36	Single Face Shelving	38 1/4"	14 1/4"	48 1/2"	11 1/2"	3	3			\$ 1,369	
	VE-4812-A-36	Single Face Adder	37"	14 1/4"	48 1/2"	11 1/2"	3	3			\$ 925	
	VE-4814-S-36	Single Face Shelving	38 1/4"	16 3/4"	48 1/2"	14"	3	3			\$ 1,438	
	VE-4814-A-36	Single Face Adder	37"	16 3/4"	48 1/2"	14"	3	3			\$ 969	
	VE-6010-S-24	Single Face Shelving	26 1/4"	12 1/4"	60 1/2"	9 1/2"	4	4			\$ 1,663	
	VE-6010-A-24	Single Face Adder	25"	12 1/4"	60 1/2"	9 1/2"	4	4			\$ 1,125	
	VE-6012-S-24	Single Face Shelving	26 1/4"	14 1/4"	60 1/2"	11 1/2"	4	4			\$ 1,756	
	VE-6012-A-24	Single Face Adder	25"	14 1/4"	60 1/2"	11 1/2"	4	4			\$ 1,181	
	VE-6014-S-24	Single Face Shelving	26 1/4"	16 3/4"	60 1/2"	14"	4	4			\$ 1,844	
	VE-6014-A-24	Single Face Adder	25"	16 3/4"	60 1/2"	14"	4	4			\$ 1,244	
Model Shown VE-6012-S-36	VE-6010-S-30	Single Face Shelving	32 1/4"	12 1/4"	60 1/2"	9 1/2"	4	4			\$ 1,663	
	VE-6010-A-30	Single Face Adder	31"	12 1/4"	60 1/2"	9 1/2"	4	4			\$ 1,125	
	VE-6012-S-30	Single Face Shelving	32 1/4"	14 1/4"	60 1/2"	11 1/2"	4	4			\$ 1,756	
	VE-6012-A-30	Single Face Adder	31"	14 1/4"	60 1/2"	11 1/2"	4	4			\$ 1,181	
	VE-6014-S-30	Single Face Shelving	32 1/4"	16 3/4"	60 1/2"	14"	4	4			\$ 1,844	
	VE-6014-A-30	Single Face Adder	31"	16 3/4"	60 1/2"	14"	4	4			\$ 1,244	
	VE-6010-S-36	Single Face Shelving	38 1/4"	12 1/4"	60 1/2"	9 1/2"	4	4			\$ 1,663	
	VE-6010-A-36	Single Face Adder	37"	12 1/4"	60 1/2"	9 1/2"	4	4			\$ 1,125	
	VE-6012-S-36	Single Face Shelving	38 1/4"	14 1/4"	60 1/2"	11 1/2"	4	4			\$ 1,756	
	VE-6012-A-36	Single Face Adder	37"	14 1/4"	60 1/2"	11 1/2"	4	4			\$ 1,181	
	VE-6014-S-36	Single Face Shelving	38 1/4"	16 3/4"	60 1/2"	14"	4	4			\$ 1,844	
	VE-6014-A-36	Single Face Adder	37"	16 3/4"	60 1/2"	14"	4	4			\$ 1,244	

MODEL NUMBER	PRODUCT	WIDTH	DEPTH	HEIGHT	SHELF DEPTH	# OF SHELVES	# OF OPENINGS	WEIGHT	VOLUME	LIST PRICE	DESCRIPTION
--------------	---------	-------	-------	--------	-------------	--------------	---------------	--------	--------	------------	-------------



Model Shown
VE-7212-S-36

VE-7210-S-24	Single Face Shelving	26 1/4"	12 1/4"	72 1/2"	9 1/2"	5	5			\$ 1,894	End & Intermediate Panels: Panel frame construction consists of 1-1/4" x 1-1/4", 16 gauge steel tube framed on all four sides and an extra vertical tube at the front edge creating a double bar open framed concept. Metal Low Back shelves adjust on 1" increments. All metal parts and components are finished in a powder epoxy, thermal enamel finish.
VE-7210-A-24	Single Face Adder	25"	12 1/4"	72 1/2"	9 1/2"	5	5			\$ 1,300	
VE-7212-S-24	Single Face Shelving	26 1/4"	14 1/4"	72 1/2"	11 1/2"	5	5			\$ 1,988	
VE-7212-A-24	Single Face Adder	25"	14 1/4"	72 1/2"	11 1/2"	5	5			\$ 1,369	
VE-7214-S-24	Single Face Shelving	26 1/4"	16 3/4"	72 1/2"	14"	5	5			\$ 2,088	
VE-7214-A-24	Single Face Adder	25"	16 3/4"	72 1/2"	14"	5	5			\$ 1,438	
VE-7210-S-30	Single Face Shelving	32 1/4"	12 1/4"	72 1/2"	9 1/2"	5	5			\$ 1,894	
VE-7210-A-30	Single Face Adder	31"	12 1/4"	72 1/2"	9 1/2"	5	5			\$ 1,300	
VE-7212-S-30	Single Face Shelving	32 1/4"	14 1/4"	72 1/2"	11 1/2"	5	5			\$ 1,988	
VE-7212-A-30	Single Face Adder	31"	14 1/4"	72 1/2"	11 1/2"	5	5			\$ 1,369	
VE-7214-S-30	Single Face Shelving	32 1/4"	16 3/4"	72 1/2"	14"	5	5			\$ 2,088	
VE-7214-A-30	Single Face Adder	31"	16 3/4"	72 1/2"	14"	5	5			\$ 1,438	



Model Shown
VE-7212-A-36

VE-7210-S-36	Single Face Shelving	38 1/4"	12 1/4"	72 1/2"	9 1/2"	5	5			\$ 1,894	Acrylic screen Insert Option: Frosted acrylic is 1/4" thick positioned in the open frame portion of End Panels. Images shown are to demonstrate the finished product with the acrylic screen insert option and are not the standard product. Please inquire with Palmieri for pricing.
VE-7210-A-36	Single Face Adder	37"	12 1/4"	72 1/2"	9 1/2"	5	5			\$ 1,300	
VE-7212-S-36	Single Face Shelving	38 1/4"	14 1/4"	72 1/2"	11 1/2"	5	5			\$ 1,988	
VE-7212-A-36	Single Face Adder	37"	14 1/4"	72 1/2"	11 1/2"	5	5			\$ 1,369	
VE-7214-S-36	Single Face Shelving	38 1/4"	16 3/4"	72 1/2"	14"	5	5			\$ 2,088	
VE-7214-A-36	Single Face Adder	37"	16 3/4"	72 1/2"	14"	5	5			\$ 1,438	



Model Shown
VE-8412-S-36

VE-8410-S-24	Single Face Shelving	26 1/4"	12 1/4"	84 1/2"	9 1/2"	6	6			\$ 2,069	
VE-8410-A-24	Single Face Adder	25"	12 1/4"	84 1/2"	9 1/2"	6	6			\$ 1,444	
VE-8412-S-24	Single Face Shelving	26 1/4"	14 1/4"	84 1/2"	11 1/2"	6	6			\$ 2,181	
VE-8412-A-24	Single Face Adder	25"	14 1/4"	84 1/2"	11 1/2"	6	6			\$ 1,525	
VE-8414-S-24	Single Face Shelving	26 1/4"	16 3/4"	84 1/2"	14"	6	6			\$ 2,294	
VE-8414-A-24	Single Face Adder	25"	16 3/4"	84 1/2"	14"	6	6			\$ 1,600	
VE-8410-S-30	Single Face Shelving	32 1/4"	12 1/4"	84 1/2"	9 1/2"	6	6			\$ 2,069	
VE-8410-A-30	Single Face Adder	31"	12 1/4"	84 1/2"	9 1/2"	6	6			\$ 1,444	
VE-8412-S-30	Single Face Shelving	32 1/4"	14 1/4"	84 1/2"	11 1/2"	6	6			\$ 2,181	
VE-8412-A-30	Single Face Adder	31"	14 1/4"	84 1/2"	11 1/2"	6	6			\$ 1,525	
VE-8414-S-30	Single Face Shelving	32 1/4"	16 3/4"	84 1/2"	14"	6	6			\$ 2,294	
VE-8414-A-30	Single Face Adder	31"	16 3/4"	84 1/2"	14"	6	6			\$ 1,600	



Model Shown
VE-8412-A-36

VE-8410-S-36	Single Face Shelving	38 1/4"	12 1/4"	84 1/2"	9 1/2"	6	6			\$ 2,069	
VE-8410-A-36	Single Face Adder	37"	12 1/4"	84 1/2"	9 1/2"	6	6			\$ 1,444	
VE-8412-S-36	Single Face Shelving	38 1/4"	14 1/4"	84 1/2"	11 1/2"	6	6			\$ 2,181	
VE-8412-A-36	Single Face Adder	37"	14 1/4"	84 1/2"	11 1/2"	6	6			\$ 1,525	
VE-8414-S-36	Single Face Shelving	38 1/4"	16 3/4"	84 1/2"	14"	6	6			\$ 2,294	
VE-8414-A-36	Single Face Adder	37"	16 3/4"	84 1/2"	14"	6	6			\$ 1,600	

SHELVING

MODEL NUMBER	PRODUCT	WIDTH	DEPTH	HEIGHT	SHELF DEPTH	# OF SHELVES	# OF OPENINGS	WEIGHT	VOLUME	LIST PRICE	DESCRIPTION
VE-9010-S-24	Single Face Shelving	26 1/4"	12 1/4"	90 1/2"	9 1/2"	7	7			\$ 2,238	<p>End & Intermediate Panels: Panel frame construction consists of 1-1/4" x 1-1/4", 16 gauge steel tube framed on all four sides and an extra vertical tube at the front edge creating a double bar open framed concept. Metal Low Back shelves adjust on 1" increments. All metal parts and components are finished in a powder epoxy, thermal enamel finish.</p> <p>Acrylic screen Insert Option: Frosted acrylic is 1/4" thick positioned in the open frame portion of End Panels. Images shown are to demonstrate the finished product with the acrylic screen insert option and are not the standard product. Please inquire with Palmieri for pricing.</p>
VE-9010-A-24	Single Face Adder	25"	12 1/4"	90 1/2"	9 1/2"	7	7			\$ 1,594	
VE-9012-S-24	Single Face Shelving	26 1/4"	14 1/4"	90 1/2"	11 1/2"	7	7			\$ 2,356	
VE-9012-A-24	Single Face Adder	25"	14 1/4"	90 1/2"	11 1/2"	7	7			\$ 1,681	
VE-9014-S-24	Single Face Shelving	26 1/4"	16 3/4"	90 1/2"	14"	7	7			\$ 2,469	
VE-9014-A-24	Single Face Adder	25"	16 3/4"	90 1/2"	14"	7	7			\$ 1,763	
VE-9010-S-30	Single Face Shelving	32 1/4"	12 1/4"	90 1/2"	9 1/2"	7	7			\$ 2,238	
VE-9010-A-30	Single Face Adder	31"	12 1/4"	90 1/2"	9 1/2"	7	7			\$ 1,594	
VE-9012-S-30	Single Face Shelving	32 1/4"	14 1/4"	90 1/2"	11 1/2"	7	7			\$ 2,356	
VE-9012-A-30	Single Face Adder	31"	14 1/4"	90 1/2"	11 1/2"	7	7			\$ 1,681	
VE-9014-S-30	Single Face Shelving	32 1/4"	16 3/4"	90 1/2"	14"	7	7			\$ 2,469	
VE-9014-A-30	Single Face Adder	31"	16 3/4"	90 1/2"	14"	7	7			\$ 1,763	
VE-9010-S-36	Single Face Shelving	38 1/4"	12 1/4"	90 1/2"	9 1/2"	7	7			\$ 2,238	
VE-9010-A-36	Single Face Adder	37"	12 1/4"	90 1/2"	9 1/2"	7	7			\$ 1,594	
VE-9012-S-36	Single Face Shelving	38 1/4"	14 1/4"	90 1/2"	11 1/2"	7	7			\$ 2,356	
VE-9012-A-36	Single Face Adder	37"	14 1/4"	90 1/2"	11 1/2"	7	7			\$ 1,681	
VE-9014-S-36	Single Face Shelving	38 1/4"	16 3/4"	90 1/2"	14"	7	7			\$ 2,469	
VE-9014-A-36	Single Face Adder	37"	16 3/4"	90 1/2"	14"	7	7			\$ 1,763	





Model Shown
VE-9012-S-36











Model Shown
VE-9012-A-36

SHELVING

	MODEL NUMBER	PRODUCT	WIDTH	DEPTH	HEIGHT	SHELF DEPTH	# OF SHELVES	# OF OPENINGS	WEIGHT	VOLUME	LIST PRICE	DESCRIPTION
 <p>Model Shown VE-4824-S-36</p>	VE-4220-S-24	Double Face Shelving	26 1/4"	24 1/2"	42 1/2"	9 1/2"	6	6			\$ 2,469	<p>End & Intermediate Panels: Panel frame construction consists of 1-1/4" x 1-1/4", 16 gauge steel tube framed on all four sides and an extra vertical tube at two front edge creating a double bar open framed concept. A center tube 1-1/4" x 2-1/2" complete this double faced frame assembly. Metal Low Back shelves adjust on 1" increments. All metal parts and components are finished in a powder epoxy, thermal enamel finish.</p> <p>Acrylic screen Insert Option: Frosted acrylic is 1/4" thick positioned in the open frame portion of End Panels. Images shown are to demonstrate the finished product with the acrylic screen insert option and are not the standard product. Please inquire with Palmieri for pricing.</p>
	VE-4220-A-24	Double Face Adder	25"	24 1/2"	42 1/2"	9 1/2"	6	6			\$ 1,725	
	VE-4224-S-24	Double Face Shelving	26 1/4"	28 1/2"	42 1/2"	11 1/2"	6	6			\$ 2,606	
	VE-4224-A-24	Double Face Adder	25"	28 1/2"	42 1/2"	11 1/2"	6	6			\$ 1,813	
	VE-4228-S-24	Double Face Shelving	26 1/4"	33 1/2"	42 1/2"	14"	6	6			\$ 2,731	
	VE-4228-A-24	Double Face Adder	25"	33 1/2"	42 1/2"	14"	6	6			\$ 1,900	
 <p>Model Shown VE-4824-A-36</p>	VE-4220-S-30	Double Face Shelving	32 1/4"	24 1/2"	42 1/2"	9 1/2"	6	6			\$ 2,469	
	VE-4220-A-30	Double Face Adder	31"	24 1/2"	42 1/2"	9 1/2"	6	6			\$ 1,725	
	VE-4224-S-30	Double Face Shelving	32 1/4"	28 1/2"	42 1/2"	11 1/2"	6	6			\$ 2,606	
	VE-4224-A-30	Double Face Adder	31"	28 1/2"	42 1/2"	11 1/2"	6	6			\$ 1,813	
	VE-4228-S-30	Double Face Shelving	32 1/4"	33 1/2"	42 1/2"	14"	6	6			\$ 2,731	
	VE-4228-A-30	Double Face Adder	31"	33 1/2"	42 1/2"	14"	6	6			\$ 1,900	
 <p>Model Shown VE-4824-S-36</p>	VE-4220-S-36	Double Face Shelving	38 1/4"	24 1/2"	42 1/2"	9 1/2"	6	6			\$ 2,469	
	VE-4220-A-36	Double Face Adder	37"	24 1/2"	42 1/2"	9 1/2"	6	6			\$ 1,725	
	VE-4224-S-36	Double Face Shelving	38 1/4"	28 1/2"	42 1/2"	11 1/2"	6	6			\$ 2,606	
	VE-4224-A-36	Double Face Adder	37"	28 1/2"	42 1/2"	11 1/2"	6	6			\$ 1,813	
	VE-4228-S-36	Double Face Shelving	38 1/4"	33 1/2"	42 1/2"	14"	6	6			\$ 2,731	
	VE-4228-A-36	Double Face Adder	37"	33 1/2"	42 1/2"	14"	6	6			\$ 1,900	

SHELVING

	MODEL NUMBER	PRODUCT	WIDTH	DEPTH	HEIGHT	SHELF DEPTH	# OF SHELVES	# OF OPENINGS	WEIGHT	VOLUME	LIST PRICE	DESCRIPTION
	VE-4820-S-24	Double Face Shelving	26 1/4"	24 1/2"	48 1/2"	9 1/2"	6	6			\$ 2,531	<p>End & Intermediate Panels: Panel frame construction consists of 1-1/4" x 1-1/4", 16 gauge steel tube framed on all four sides and an extra vertical tube at two front edge creating a double bar open framed concept. A center tube 1-1/4" x 2-1/2" complete this double faced frame assembly. Metal Low Back shelves adjust on 1" increments. All metal parts and components are finished in a powder epoxy, thermal enamel finish.</p> <p>Acrylic screen Insert Option: Frosted acrylic is 1/4" thick positioned in the open frame portion of End Panels. Images shown are to demonstrate the finished product with the acrylic screen insert option and are not the standard product. Please inquire with Palmieri for pricing.</p>
	VE-4820-A-24	Double Face Adder	25"	24 1/2"	48 1/2"	9 1/2"	6	6			\$ 1,750	
	VE-4824-S-24	Double Face Shelving	26 1/4"	28 1/2"	48 1/2"	11 1/2"	6	6			\$ 2,663	
	VE-4824-A-24	Double Face Adder	25"	28 1/2"	48 1/2"	11 1/2"	6	6			\$ 1,844	
	VE-4828-S-24	Double Face Shelving	26 1/4"	33 1/2"	48 1/2"	14"	6	6			\$ 2,794	
	VE-4828-A-24	Double Face Adder	25"	33 1/2"	48 1/2"	14"	6	6			\$ 1,938	
Model Shown VE-4824-S-36	VE-4820-S-30	Double Face Shelving	32 1/4"	24 1/2"	48 1/2"	9 1/2"	6	6			\$ 2,531	
	VE-4820-A-30	Double Face Adder	31"	24 1/2"	48 1/2"	9 1/2"	6	6			\$ 1,750	
	VE-4824-S-30	Double Face Shelving	32 1/4"	28 1/2"	48 1/2"	11 1/2"	6	6			\$ 2,663	
	VE-4824-A-30	Double Face Adder	31"	28 1/2"	48 1/2"	11 1/2"	6	6			\$ 1,844	
	VE-4828-S-30	Double Face Shelving	32 1/4"	33 1/2"	48 1/2"	14"	6	6			\$ 2,794	
	VE-4828-A-30	Double Face Adder	31"	33 1/2"	48 1/2"	14"	6	6			\$ 1,938	
	VE-4820-S-36	Double Face Shelving	38 1/4"	24 1/2"	48 1/2"	9 1/2"	6	6			\$ 2,531	
	VE-4820-A-36	Double Face Adder	37"	24 1/2"	48 1/2"	9 1/2"	6	6			\$ 1,750	
	VE-4824-S-36	Double Face Shelving	38 1/4"	28 1/2"	48 1/2"	11 1/2"	6	6			\$ 2,663	
	VE-4824-A-36	Double Face Adder	37"	28 1/2"	48 1/2"	11 1/2"	6	6			\$ 1,844	
	VE-4828-S-36	Double Face Shelving	38 1/4"	33 1/2"	48 1/2"	14"	6	6			\$ 2,794	
	VE-4828-A-36	Double Face Adder	37"	33 1/2"	48 1/2"	14"	6	6			\$ 1,938	
	VE-6020-S-24	Double Face Shelving	26 1/4"	24 1/2"	60 1/2"	9 1/2"	8	8			\$ 2,988	
	VE-6020-A-24	Double Face Adder	25"	24 1/2"	60 1/2"	9 1/2"	8	8			\$ 2,106	
	VE-6024-S-24	Double Face Shelving	26 1/4"	28 1/2"	60 1/2"	11 1/2"	8	8			\$ 3,144	
	VE-6024-A-24	Double Face Adder	25"	28 1/2"	60 1/2"	11 1/2"	8	8			\$ 2,213	
	VE-6028-S-24	Double Face Shelving	26 1/4"	33 1/2"	60 1/2"	14"	8	8			\$ 3,300	
	VE-6028-A-24	Double Face Adder	25"	33 1/2"	60 1/2"	14"	8	8			\$ 2,319	
	VE-6020-S-30	Double Face Shelving	32 1/4"	24 1/2"	60 1/2"	9 1/2"	8	8			\$ 2,988	
	VE-6020-A-30	Double Face Adder	31"	24 1/2"	60 1/2"	9 1/2"	8	8			\$ 2,106	
	VE-6024-S-30	Double Face Shelving	32 1/4"	28 1/2"	60 1/2"	11 1/2"	8	8			\$ 3,144	
	VE-6024-A-30	Double Face Adder	31"	28 1/2"	60 1/2"	11 1/2"	8	8			\$ 2,213	
	VE-6028-S-30	Double Face Shelving	32 1/4"	33 1/2"	60 1/2"	14"	8	8			\$ 3,300	
	VE-6028-A-30	Double Face Adder	31"	33 1/2"	60 1/2"	14"	8	8			\$ 2,319	
	VE-6020-S-36	Double Face Shelving	38 1/4"	24 1/2"	60 1/2"	9 1/2"	8	8			\$ 2,988	
	VE-6020-A-36	Double Face Adder	37"	24 1/2"	60 1/2"	9 1/2"	8	8			\$ 2,106	
	VE-6024-S-36	Double Face Shelving	38 1/4"	28 1/2"	60 1/2"	11 1/2"	8	8			\$ 3,144	
	VE-6024-A-36	Double Face Adder	37"	28 1/2"	60 1/2"	11 1/2"	8	8			\$ 2,213	
	VE-6028-S-36	Double Face Shelving	38 1/4"	33 1/2"	60 1/2"	14"	8	8			\$ 3,300	
	VE-6028-A-36	Double Face Adder	37"	33 1/2"	60 1/2"	14"	8	8			\$ 2,319	

	MODEL NUMBER	PRODUCT	WIDTH	DEPTH	HEIGHT	SHELF DEPTH	# OF SHELVES	# OF OPENINGS	WEIGHT	VOLUME	LIST PRICE	DESCRIPTION
 Model Shown VE-7224-S-36	VE-7220-S-24	Double Face Shelving	26 1/4"	24 1/2"	72 1/2"	9 1/2"	10	10			\$ 3,356	End & Intermediate Panels: Panel frame construction consists of 1-1/4" x 1-1/4", 16 gauge steel tube framed on all four sides and an extra vertical tube at two front edge creating a double bar open framed concept. A center tube 1-1/4" x 2-1/2" complete this double faced frame assembly. Metal Low Back shelves adjust on 1" increments. All metal parts and components are finished in a powder epoxy, thermal enamel finish. Acrylic screen Insert Option: Frosted acrylic is 1/4" thick positioned in the open frame portion of End Panels. Images shown are to demonstrate the finished product with the acrylic screen insert option and are not the standard product. Please inquire with Palmieri for pricing.
	VE-7220-A-24	Double Face Adder	25"	24 1/2"	72 1/2"	9 1/2"	10	10			\$ 2,406	
	VE-7224-S-24	Double Face Shelving	26 1/4"	28 1/2"	72 1/2"	11 1/2"	10	10			\$ 3,531	
	VE-7224-A-24	Double Face Adder	25"	28 1/2"	72 1/2"	11 1/2"	10	10			\$ 2,531	
	VE-7228-S-24	Double Face Shelving	26 1/4"	33 1/2"	72 1/2"	14"	10	10			\$ 3,706	
	VE-7228-A-24	Double Face Adder	25"	33 1/2"	72 1/2"	14"	10	10			\$ 2,656	
	VE-7220-S-30	Double Face Shelving	32 1/4"	24 1/2"	72 1/2"	9 1/2"	10	10			\$ 3,356	
	VE-7220-A-30	Double Face Adder	31"	24 1/2"	72 1/2"	9 1/2"	10	10			\$ 2,406	
	VE-7224-S-30	Double Face Shelving	32 1/4"	28 1/2"	72 1/2"	11 1/2"	10	10			\$ 3,531	
	VE-7224-A-30	Double Face Adder	31"	28 1/2"	72 1/2"	11 1/2"	10	10			\$ 2,531	
VE-7228-S-30	Double Face Shelving	32 1/4"	33 1/2"	72 1/2"	14"	10	10			\$ 3,706		
VE-7228-A-30	Double Face Adder	31"	33 1/2"	72 1/2"	14"	10	10			\$ 2,656		
 Model Shown VE-7224-A-36	VE-7220-S-36	Double Face Shelving	38 1/4"	24 1/2"	72 1/2"	9 1/2"	10	10			\$ 3,356	
	VE-7220-A-36	Double Face Adder	37"	24 1/2"	72 1/2"	9 1/2"	10	10			\$ 2,406	
	VE-7224-S-36	Double Face Shelving	38 1/4"	28 1/2"	72 1/2"	11 1/2"	10	10			\$ 3,531	
	VE-7224-A-36	Double Face Adder	37"	28 1/2"	72 1/2"	11 1/2"	10	10			\$ 2,531	
	VE-7228-S-36	Double Face Shelving	38 1/4"	33 1/2"	72 1/2"	14"	10	10			\$ 3,706	
	VE-7228-A-36	Double Face Adder	37"	33 1/2"	72 1/2"	14"	10	10			\$ 2,656	
 Model Shown VE-8424-S-36	VE-8420-S-24	Double Face Shelving	26 1/4"	24 1/2"	84 1/2"	9 1/2"	12	12			\$ 3,656	
	VE-8420-A-24	Double Face Adder	25"	24 1/2"	84 1/2"	9 1/2"	12	12			\$ 2,675	
	VE-8424-S-24	Double Face Shelving	26 1/4"	28 1/2"	84 1/2"	11 1/2"	12	12			\$ 3,850	
	VE-8424-A-24	Double Face Adder	25"	28 1/2"	84 1/2"	11 1/2"	12	12			\$ 2,819	
	VE-8428-S-24	Double Face Shelving	26 1/4"	33 1/2"	84 1/2"	14"	12	12			\$ 4,044	
	VE-8428-A-24	Double Face Adder	25"	33 1/2"	84 1/2"	14"	12	12			\$ 2,956	
	VE-8420-S-30	Double Face Shelving	32 1/4"	24 1/2"	84 1/2"	9 1/2"	12	12			\$ 3,656	
	VE-8420-A-30	Double Face Adder	31"	24 1/2"	84 1/2"	9 1/2"	12	12			\$ 2,675	
	VE-8424-S-30	Double Face Shelving	32 1/4"	28 1/2"	84 1/2"	11 1/2"	12	12			\$ 3,850	
	VE-8424-A-30	Double Face Adder	31"	28 1/2"	84 1/2"	11 1/2"	12	12			\$ 2,819	
VE-8428-S-30	Double Face Shelving	32 1/4"	33 1/2"	84 1/2"	14"	12	12			\$ 4,044		
VE-8428-A-30	Double Face Adder	31"	33 1/2"	84 1/2"	14"	12	12			\$ 2,956		
 Model Shown VE-8424-A-36	VE-8420-S-36	Double Face Shelving	38 1/4"	24 1/2"	84 1/2"	9 1/2"	12	12			\$ 3,656	
	VE-8420-A-36	Double Face Adder	37"	24 1/2"	84 1/2"	9 1/2"	12	12			\$ 2,675	
	VE-8424-S-36	Double Face Shelving	38 1/4"	28 1/2"	84 1/2"	11 1/2"	12	12			\$ 3,850	
	VE-8424-A-36	Double Face Adder	37"	28 1/2"	84 1/2"	11 1/2"	12	12			\$ 2,819	
	VE-8428-S-36	Double Face Shelving	38 1/4"	33 1/2"	84 1/2"	14"	12	12			\$ 4,044	
	VE-8428-A-36	Double Face Adder	37"	33 1/2"	84 1/2"	14"	12	12			\$ 2,956	

MODEL NUMBER	PRODUCT	WIDTH	DEPTH	HEIGHT	SHELF DEPTH	# OF SHELVES	# OF OPENINGS	WEIGHT	VOLUME	LIST PRICE	DESCRIPTION
VE-9020-S-24	Double Face Shelving	26 1/4"	24 1/2"	90 1/2"	9 1/2"	14	14			\$ 3,944	<p>End & Intermediate Panels: Panel frame construction consists of 1-1/4" x 1-1/4", 16 gauge steel tube framed on all four sides and an extra vertical tube at two front edge creating a double bar open framed concept. A center tube 1-1/4" x 2-1/2" complete this double faced frame assembly. Metal Low Back shelves adjust on 1" increments. All metal parts and components are finished in a powder epoxy, thermal enamel finish.</p> <p>Acrylic screen Insert Option: Frosted acrylic is 1/4" thick positioned in the open frame portion of End Panels. Images shown are to demonstrate the finished product with the acrylic screen insert option and are not the standard product. Please inquire with Palmieri for pricing.</p>
VE-9020-A-24	Double Face Adder	25"	24 1/2"	90 1/2"	9 1/2"	14	14			\$ 2,944	
VE-9024-S-24	Double Face Shelving	26 1/4"	28 1/2"	90 1/2"	11 1/2"	14	14			\$ 4,156	
VE-9024-A-24	Double Face Adder	25"	28 1/2"	90 1/2"	11 1/2"	14	14			\$ 3,100	
VE-9028-S-24	Double Face Shelving	26 1/4"	33 1/2"	90 1/2"	14"	14	14			\$ 4,363	
VE-9028-A-24	Double Face Adder	25"	33 1/2"	90 1/2"	14"	14	14			\$ 3,256	
VE-9020-S-30	Double Face Shelving	32 1/4"	24 1/2"	90 1/2"	9 1/2"	14	14			\$ 3,944	
VE-9020-A-30	Double Face Adder	31"	24 1/2"	90 1/2"	9 1/2"	14	14			\$ 2,944	
VE-9024-S-30	Double Face Shelving	32 1/4"	28 1/2"	90 1/2"	11 1/2"	14	14			\$ 4,156	
VE-9024-A-30	Double Face Adder	31"	28 1/2"	90 1/2"	11 1/2"	14	14			\$ 3,100	
VE-9028-S-30	Double Face Shelving	32 1/4"	33 1/2"	90 1/2"	14"	14	14			\$ 4,363	
VE-9028-A-30	Double Face Adder	31"	33 1/2"	90 1/2"	14"	14	14			\$ 3,256	
VE-9020-S-36	Double Face Shelving	38 1/4"	24 1/2"	90 1/2"	9 1/2"	14	14			\$ 3,944	
VE-9020-A-36	Double Face Adder	37"	24 1/2"	90 1/2"	9 1/2"	14	14			\$ 2,944	
VE-9024-S-36	Double Face Shelving	38 1/4"	28 1/2"	90 1/2"	11 1/2"	14	14			\$ 4,156	
VE-9024-A-36	Double Face Adder	37"	28 1/2"	90 1/2"	11 1/2"	14	14			\$ 3,100	
VE-9028-S-36	Double Face Shelving	38 1/4"	33 1/2"	90 1/2"	14"	14	14			\$ 4,363	
VE-9028-A-36	Double Face Adder	37"	33 1/2"	90 1/2"	14"	14	14			\$ 3,256	



Model Shown
VE-9024-S-36



Model Shown
VE-9024-A-36

SHELVING

MODEL NUMBER	PRODUCT	WIDTH	DEPTH	HEIGHT	SHELF DEPTH	# OF SHELVES	# OF OPENINGS	WEIGHT	VOLUME	LIST PRICE	DESCRIPTION
VE-4212-S-M-24	Single Face Shelving	26 ¹ / ₄ "	12"	42 ¹ / ₂ "	11 ¹ / ₂ "	3	3			\$ 1,913	End & Intermediate Panels: Panel frame construction consists of 1-1/4" x 1-1/4", 16 gauge steel tube framed on all four sides and an extra vertical tube at the front edge creating a double bar open framed concept. Metal Low Back shelves adjust on 1" increments. All metal parts and components are finished in a powder epoxy, thermal enamel finish. Acrylic screen Insert Option: Frosted acrylic is 1/4" thick positioned in the open frame portion of End Panels. Images shown are to demonstrate the finished product with the acrylic screen insert option and are not the standard product. Please inquire with Palmieri for pricing.
VE-4212-A-M-24	Single Face Adder	25"	12"	42 ¹ / ₂ "	11 ¹ / ₂ "	3	3			\$ 1,494	
VE-4212-S-M-30	Single Face Shelving	32 ¹ / ₄ "	12"	42 ¹ / ₂ "	11 ¹ / ₂ "	3	3			\$ 1,913	
VE-4212-A-M-30	Single Face Adder	31"	12"	42 ¹ / ₂ "	11 ¹ / ₂ "	3	3			\$ 1,494	
VE-4212-S-M-36	Single Face Shelving	38 ¹ / ₄ "	12"	42 ¹ / ₂ "	11 ¹ / ₂ "	3	3			\$ 1,913	
VE-4212-A-M-36	Single Face Adder	37"	12"	42 ¹ / ₂ "	11 ¹ / ₂ "	3	3			\$ 1,494	



Model Shown
VE-4812-S-M-36



Model Shown
VE-4812-A-M-36

SHELVING

MODEL NUMBER	PRODUCT	WIDTH	DEPTH	HEIGHT	SHELF DEPTH	# OF SHELVES	# OF OPENINGS	WEIGHT	VOLUME	LIST PRICE	DESCRIPTION
--------------	---------	-------	-------	--------	-------------	--------------	---------------	--------	--------	------------	-------------



Model Shown
VE-4812-S-M-36

VE-4812-S-M-24	Single Face Shelving	26 ¹ / ₄ "	12"	48 ¹ / ₂ "	11 ¹ / ₂ "	3	3			\$ 1,963	End & Intermediate Panels: Panel frame construction consists of 1-1/4" x 1-1/4", 16 gauge steel tube framed on all four sides and an extra vertical tube at the front edge creating a double bar open framed concept. Metal Low Back shelves adjust on 1" increments. All metal parts and components are finished in a powder epoxy, thermal enamel finish.
VE-4812-A-M-24	Single Face Adder	25"	12"	48 ¹ / ₂ "	11 ¹ / ₂ "	3	3			\$ 1,519	
VE-4812-S-M-30	Single Face Shelving	32 ¹ / ₄ "	12"	48 ¹ / ₂ "	11 ¹ / ₂ "	3	3			\$ 1,963	
VE-4812-A-M-30	Single Face Adder	31"	12"	48 ¹ / ₂ "	11 ¹ / ₂ "	3	3			\$ 1,519	
VE-4812-S-M-36	Single Face Shelving	38 ¹ / ₄ "	12"	48 ¹ / ₂ "	11 ¹ / ₂ "	3	3			\$ 1,963	
VE-4812-A-M-36	Single Face Adder	37"	12"	48 ¹ / ₂ "	11 ¹ / ₂ "	3	3			\$ 1,519	



Model Shown
VE-4812-A-M-36

Acrylic screen Insert Option:
Frosted acrylic is 1/4" thick positioned in the open frame portion of End Panels. Images shown are to demonstrate the finished product with the acrylic screen insert option and are not the standard product. Please inquire with Palmieri for pricing.



Model Shown
VE-6012-S-M-36

VE-6012-S-M-24	Single Face Shelving	26 ¹ / ₄ "	12"	60 ¹ / ₂ "	11 ¹ / ₂ "	4	4			\$ 2,544	
VE-6012-A-M-24	Single Face Adder	25"	12"	60 ¹ / ₂ "	11 ¹ / ₂ "	4	4			\$ 1,975	
VE-6012-S-M-30	Single Face Shelving	32 ¹ / ₄ "	12"	60 ¹ / ₂ "	11 ¹ / ₂ "	4	4			\$ 2,544	
VE-6012-A-M-30	Single Face Adder	31"	12"	60 ¹ / ₂ "	11 ¹ / ₂ "	4	4			\$ 1,975	
VE-6012-S-M-36	Single Face Shelving	38 ¹ / ₄ "	12"	60 ¹ / ₂ "	11 ¹ / ₂ "	4	4			\$ 2,544	
VE-6012-A-M-36	Single Face Adder	37"	12"	60 ¹ / ₂ "	11 ¹ / ₂ "	4	4			\$ 1,975	



Model Shown
VE-6012-A-M-36

SHELVING

MODEL NUMBER	PRODUCT	WIDTH	DEPTH	HEIGHT	SHELF DEPTH	# OF SHELVES	# OF OPENINGS	WEIGHT	VOLUME	LIST PRICE	DESCRIPTION
VE-7212-S-M-24	Single Face Shelving	26 1/4"	12"	72 1/2"	11 1/2"	5	5			\$ 2,981	End & Intermediate Panels: Panel frame construction consists of 1-1/4" x 1-1/4", 16 gauge steel tube framed on all four sides and an extra vertical tube at the front edge creating a double bar open framed concept. Metal Low Back shelves adjust on 1" increments. All metal parts and components are finished in a powder epoxy, thermal enamel finish. Acrylic screen Insert Option: Frosted acrylic is 1/4" thick positioned in the open frame portion of End Panels. Images shown are to demonstrate the finished product with the acrylic screen insert option and are not the standard product. Please inquire with Palmieri for pricing.
VE-7212-A-M-24	Single Face Adder	25"	12"	72 1/2"	11 1/2"	5	5			\$ 2,356	
VE-7212-S-M-30	Single Face Shelving	32 1/4"	12"	72 1/2"	11 1/2"	5	5			\$ 2,981	
VE-7212-A-M-30	Single Face Adder	31"	12"	72 1/2"	11 1/2"	5	5			\$ 2,356	
VE-7212-S-M-36	Single Face Shelving	38 1/4"	12"	72 1/2"	11 1/2"	5	5			\$ 2,981	
VE-7212-A-M-36	Single Face Adder	37"	12"	72 1/2"	11 1/2"	5	5			\$ 2,356	



Model Shown
VE-7212-S-M-36



Model Shown
VE-7212-A-M-36

VE-8412-S-M-24	Single Face Shelving	26 1/4"	12"	84 1/2"	11 1/2"	6	6			\$ 3,363
VE-8412-A-M-24	Single Face Adder	25"	12"	84 1/2"	11 1/2"	6	6			\$ 2,713
VE-8412-S-M-30	Single Face Shelving	32 1/4"	12"	84 1/2"	11 1/2"	6	6			\$ 3,363
VE-8412-A-M-30	Single Face Adder	31"	12"	84 1/2"	11 1/2"	6	6			\$ 2,713
VE-8412-S-M-36	Single Face Shelving	38 1/4"	12"	84 1/2"	11 1/2"	6	6			\$ 3,363
VE-8412-A-M-36	Single Face Adder	37"	12"	84 1/2"	11 1/2"	6	6			\$ 2,713



Model Shown
VE-8412-S-M-36



Model Shown
VE-8412-A-M-36

SHELVING

MODEL NUMBER	PRODUCT	WIDTH	DEPTH	HEIGHT	SHELF DEPTH	# OF SHELVES	# OF OPENINGS	WEIGHT	VOLUME	LIST PRICE	DESCRIPTION
VE-4224-S-M-24	Double Face Shelving	26 1/4"	24"	42 1/2"	11 1/2"	6	6			\$ 3,788	<p>End & Intermediate Panels: Panel frame construction consists of 1-1/4" x 1-1/4", 16 gauge steel tube framed on all four sides and an extra vertical tube at two front edge creating a double bar open framed concept. A center tube 1-1/4" x 2-1/2" complete this double faced frame assembly. Metal Low Back shelves adjust on 1" increments. All metal parts and components are finished in a powder epoxy, thermal enamel finish.</p> <p>Acrylic screen Insert Option: Frosted acrylic is 1/4" thick positioned in the open frame portion of End Panels. Images shown are to demonstrate the finished product with the acrylic screen insert option and are not the standard product. Please inquire with Palmieri for pricing.</p>
VE-4224-A-M-24	Double Face Adder	25"	24"	42 1/2"	11 1/2"	6	6			\$ 3,000	
VE-4224-S-M-30	Double Face Shelving	32 1/4"	24"	42 1/2"	11 1/2"	6	6			\$ 3,788	
VE-4224-A-M-30	Double Face Adder	31"	24"	42 1/2"	11 1/2"	6	6			\$ 3,000	
VE-4224-S-M-36	Double Face Shelving	38 1/4"	24"	42 1/2"	11 1/2"	6	6			\$ 3,788	
VE-4224-A-M-36	Double Face Adder	37"	24"	42 1/2"	11 1/2"	6	6			\$ 3,000	



Model Shown
VE-4824-S-M-36



Model Shown
VE-4824-A-M-36

MODEL NUMBER	PRODUCT	WIDTH	DEPTH	HEIGHT	SHELF DEPTH	# OF SHELVES	# OF OPENINGS	WEIGHT	VOLUME	LIST PRICE	DESCRIPTION
--------------	---------	-------	-------	--------	-------------	--------------	---------------	--------	--------	------------	-------------



Model Shown
VE-4824-S-M-36

VE-4824-S-M-24	Double Face Shelving	26 1/4"	24"	48 1/2"	11 1/2"	6	6			\$ 3,850	End & Intermediate Panels: Panel frame construction consists of 1-1/4" x 1-1/4", 16 gauge steel tube framed on all four sides and an extra vertical tube at two front edge creating a double bar open framed concept. A center tube 1-1/4" x 2-1/2" complete this double faced frame assembly. Metal Low Back shelves adjust on 1" increments. All metal parts and components are finished in a powder epoxy, thermal enamel finish.
VE-4824-A-M-24	Double Face Adder	25"	24"	48 1/2"	11 1/2"	6	6			\$ 3,031	
VE-4824-S-M-30	Double Face Shelving	32 1/4"	24"	48 1/2"	11 1/2"	6	6			\$ 3,850	
VE-4824-A-M-30	Double Face Adder	31"	24"	48 1/2"	11 1/2"	6	6			\$ 3,031	
VE-4824-S-M-36	Double Face Shelving	38 1/4"	24"	48 1/2"	11 1/2"	6	6			\$ 3,850	
VE-4824-A-M-36	Double Face Adder	37"	24"	48 1/2"	11 1/2"	6	6			\$ 3,031	



Model Shown
VE-4824-A-M-36

VE-6024-S-M-24	Double Face Shelving	26 1/4"	24"	60 1/2"	11 1/2"	8	8			\$ 4,731	Acrylic screen Insert Option: Frosted acrylic is 1/4" thick positioned in the open frame portion of End Panels. Images shown are to demonstrate the finished product with the acrylic screen insert option and are not the standard product. Please inquire with Palmieri for pricing.
VE-6024-A-M-24	Double Face Adder	25"	24"	60 1/2"	11 1/2"	8	8			\$ 3,794	
VE-6024-S-M-30	Double Face Shelving	32 1/4"	24"	60 1/2"	11 1/2"	8	8			\$ 4,731	
VE-6024-A-M-30	Double Face Adder	31"	24"	60 1/2"	11 1/2"	8	8			\$ 3,794	
VE-6024-S-M-36	Double Face Shelving	38 1/4"	24"	60 1/2"	11 1/2"	8	8			\$ 4,731	
VE-6024-A-M-36	Double Face Adder	37"	24"	60 1/2"	11 1/2"	8	8			\$ 3,794	



Model Shown
VE-6024-S-M-36



Model Shown
VE-6024-A-M-36

SHELVING

MODEL NUMBER	PRODUCT	WIDTH	DEPTH	HEIGHT	SHELF DEPTH	# OF SHELVES	# OF OPENINGS	WEIGHT	VOLUME	LIST PRICE	DESCRIPTION
VE-7224-S-M-24	Double Face Shelving	26 1/4"	24"	72 1/2"	11 1/2"	10	10			\$ 5,506	End & Intermediate Panels: Panel frame construction consists of 1-1/4" x 1-1/4", 16 gauge steel tube framed on all four sides and an extra vertical tube at two front edge creating a double bar open framed concept. A center tube 1-1/4" x 2-1/2" complete this double faced frame assembly. Metal Low Back shelves adjust on 1" increments. All metal parts and components are finished in a powder epoxy, thermal enamel finish. Acrylic screen Insert Option: Frosted acrylic is 1/4" thick positioned in the open frame portion of End Panels. Images shown are to demonstrate the finished product with the acrylic screen insert option and are not the standard product. Please inquire with Palmieri for pricing.
VE-7224-A-M-24	Double Face Adder	25"	24"	72 1/2"	11 1/2"	10	10			\$ 4,513	
VE-7224-S-M-30	Double Face Shelving	32 1/4"	24"	72 1/2"	11 1/2"	10	10			\$ 5,506	
VE-7224-A-M-30	Double Face Adder	31"	24"	72 1/2"	11 1/2"	10	10			\$ 4,513	
VE-7224-S-M-36	Double Face Shelving	38 1/4"	24"	72 1/2"	11 1/2"	10	10			\$ 5,506	
VE-7224-A-M-36	Double Face Adder	37"	24"	72 1/2"	11 1/2"	10	10			\$ 4,513	



Model Shown
VE-7224-S-M-36



Model Shown
VE-7224-A-M-36

VE-8424-S-M-24	Double Face Shelving	26 1/4"	24"	84 1/2"	11 1/2"	12	12			\$ 6,219
VE-8424-A-M-24	Double Face Adder	25"	24"	84 1/2"	11 1/2"	12	12			\$ 5,194
VE-8424-S-M-30	Double Face Shelving	32 1/4"	24"	84 1/2"	11 1/2"	12	12			\$ 6,219
VE-8424-A-M-30	Double Face Adder	31"	24"	84 1/2"	11 1/2"	12	12			\$ 5,194
VE-8424-S-M-36	Double Face Shelving	38 1/4"	24"	84 1/2"	11 1/2"	12	12			\$ 6,219
VE-8424-A-M-36	Double Face Adder	37"	24"	84 1/2"	11 1/2"	12	12			\$ 5,194









Model Shown
VE-8424-S-M-36

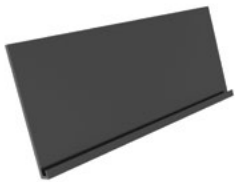

Model Shown
VE-8424-A-M-36

SHELVING

	MODEL NUMBER	PRODUCT	WIDTH	DEPTH	HEIGHT	WEIGHT	VOLUME	LIST PRICE	DESCRIPTION
 <p>Model Shown VE-SL12-36</p>	SL10-24	Slotted Metal Shelf	23 1/4"	9 1/2"	5"			\$ 194	Divider shelf is 5" high with 3 metal dividers. Shelf is slotted at 2" intervals. Includes two side brackets for installation.
	SL12-24		23 1/4"	11 1/2"	5"			\$ 194	
	SL10-30		29 1/4"	9 1/2"	5"			\$ 194	
	SL12-30		29 1/4"	11 1/2"	5"			\$ 194	
	SL10-36		35 1/4"	9 1/2"	5"			\$ 206	
	SL12-36		35 1/4"	11 1/2"	5"			\$ 206	
 <p>Model Shown VE-LB12-36</p>	M-LB10-24	Low Back Metal Shelf	23 1/4"	9 1/2"				\$ 81	18 gauge metal shelf with a 1-1/4" high book stop back lip. Includes two side brackets for installation.
	M-LB12-24		23 1/4"	11 1/2"				\$ 81	
	M-LB14-24		23 1/4"	14"				\$ 88	
	M-LB10-30		29 1/4"	9 1/2"				\$ 81	
	M-LB12-30		29 1/4"	11 1/2"				\$ 81	
	M-LB14-30		29 1/4"	14"				\$ 88	
	M-LB10-36		35 1/4"	9 1/2"				\$ 75	
	M-LB12-36		35 1/4"	11 1/2"				\$ 81	
	M-LB14-36		35 1/4"	14"				\$ 81	
 <p>Model Shown VE-M12-36</p>	VE-ME12-24	Metal Media Shelf	23 1/4"	12"		15 Lbs.	1 Cu Ft	\$ 194	Hinged metal magazine shelf with 12" height and 1" deep x 3/4" high lip. Includes two side brackets for installation.
	VE-ME12-30		29 1/4"	12"				\$ 194	
	VE-ME12-36		35 1/4"	12"				\$ 194	

	MODEL NUMBER	PRODUCT	WIDTH	DEPTH	HEIGHT	WEIGHT	VOLUME	LIST PRICE	DESCRIPTION
	M-SL-D10	Divider	9 1/2"		5"			\$ 38	Metal Dividers for divider shelf are 5" high and come in depths of 9 1/2" and 11 1/2".
	M-SL-D12		11 1/2"		5"			\$ 44	
	WBS-01	Wire Book Support - For Low Back Shelf			6 1/2"			\$ 25	Chrome Clip-on wire book support for low back shelves.
	S-SB	Sway Brace	60"					\$ 113	

	MODEL NUMBER	PRODUCT	WIDTH	DEPTH	HEIGHT	WEIGHT	VOLUME	LIST PRICE	DESCRIPTION
 <p>Model Shown VE-BE6</p>	M-BE6	Metal Book End			6"			\$ 19	Metal book end stop with rubber bottoms.
	M-BE9				9"			\$ 25	
 <p>Model Shown VE-BCB36</p>	VE-BCB24	24" Top & Base Crossbar	24"		1 1/4"			\$ 50	Made of 1 1/4" x 1 1/4" powder coat painted metal tube. Bolts unit at the middle and the base. Includes four attachment bolts for installation.
	VE-BCB30	30" Top & Base Crossbar	30"		1 1/4"			\$ 50	
	VE-BCB36	36" Top & Base Crossbar	36"		1 1/4"			\$ 50	
 <p>Model Shown VE-KP36</p>	VE-KP24	24" Kickplate	9 1/2"		2"			\$ 81	Metal 2" high kickplate installs with two drop-in pins and comes in sizes of 24", 30", and 36" wide. Includes two attachment pins for installation.
	VE-KP30	30" Kickplate						\$ 81	
	VE-KP36	36" Kickplate	11 1/2"		2"			\$ 75	
 <p>Model Shown VE-CT-BKT-DF</p>	VE-CT-BKT-SF	Single Face Canopy Top Bracket						\$ 44	Canopy top brackets are used to secure wood tops to the Venue top crossbar which includes wood screws for installation. Two brackets are required for starter units and one bracket is required for adder units.
	VE-CT-BKT-DF	Double Face Canopy Top Bracket						\$ 44	
 <p>Model Shown VE-MS3624</p>	VE-MS3624	Mobile Shelving Bottom Frame (Maximum of 60 1/2" H Units)	36"	24"				\$ 513	



Model Shown
VE-BA7212M
Mid Panel

MODEL NUMBER	PRODUCT	WIDTH	DEPTH	HEIGHT	WEIGHT	VOLUME	LIST PRICE	DESCRIPTION
VE-BA4210E	Single Face Bolt Assembly		12 1/4"	42 1/2"			\$ 400	<p>End & Intermediate Panels: Panel frame construction consists of 1-1/4" x 1-1/4", 16 gauge steel tube framed on all four sides and an extra vertical tube at the front edge creating a double bar open framed concept. Metal Low Back shelves adjust on 1" increments. All metal parts and components are finished in a powder epoxy, thermal enamel finish.</p> <p>Acrylic screen Insert Option: Frosted acrylic is 1/4" thick positioned in the open frame portion of End Panels. Images shown are to demonstrate the finished product with the acrylic screen insert option and are not the standard product. Please inquire with Palmieri for pricing.</p>
VE-BA4810E	End Panels		12 1/4"	48 1/2"			\$ 419	
VE-BA6010E			12 1/4"	60 1/2"			\$ 544	
VE-BA7210E			12 1/4"	72 1/2"			\$ 594	
VE-BA8410E			12 1/4"	84 1/2"			\$ 625	
VE-BA9610E			12 1/4"	96 1/2"			\$ 650	
VE-BA4212E			14 1/4"	42 1/2"			\$ 400	
VE-BA4812E			14 1/4"	48 1/2"			\$ 425	
VE-BA6012E			14 1/4"	60 1/2"			\$ 550	
VE-BA7212E			14 1/4"	72 1/2"			\$ 600	
VE-BA8412E			14 1/4"	84 1/2"			\$ 631	
VE-BA9612E			14 1/4"	96 1/2"			\$ 656	
VE-BA4214E			16 3/4"	42 1/2"			\$ 406	
VE-BA4814E			16 3/4"	48 1/2"			\$ 431	
VE-BA6014E			16 3/4"	60 1/2"			\$ 556	
VE-BA7214E			16 3/4"	72 1/2"			\$ 606	
VE-BA8414E			16 3/4"	84 1/2"			\$ 638	
VE-BA9614E			16 3/4"	96 1/2"			\$ 656	
VE-BA4210M	Single Face Bolt Assembly		12 1/4"	42 1/2"			\$ 444	
VE-BA4810M	Mid Panels		12 1/4"	48 1/2"			\$ 469	
VE-BA6010M			12 1/4"	60 1/2"			\$ 594	
VE-BA7210M			12 1/4"	72 1/2"			\$ 644	
VE-BA8410M			12 1/4"	84 1/2"			\$ 675	
VE-BA9610M			12 1/4"	96 1/2"			\$ 694	
VE-BA4212M			14 1/4"	42 1/2"			\$ 450	
VE-BA4812M			14 1/4"	48 1/2"			\$ 475	
VE-BA6012M			14 1/4"	60 1/2"			\$ 594	
VE-BA7212M			14 1/4"	72 1/2"			\$ 650	
VE-BA8412M			14 1/4"	84 1/2"			\$ 675	
VE-BA9612M			14 1/4"	96 1/2"			\$ 700	
VE-BA4214M			16 3/4"	42 1/2"			\$ 456	
VE-BA4814M			16 3/4"	48 1/2"			\$ 475	
VE-BA6014M			16 3/4"	60 1/2"			\$ 600	
VE-BA7214M			16 3/4"	72 1/2"			\$ 656	
VE-BA8414M			16 3/4"	84 1/2"			\$ 681	
VE-BA9614M			16 3/4"	96 1/2"			\$ 706	



Model Shown
VE-BA7224M
Mid Panel

MODEL NUMBER	PRODUCT	WIDTH	DEPTH	HEIGHT	WEIGHT	VOLUME	LIST PRICE	DESCRIPTION	
VE-BA4220E	Double Face Bolt Assembly End Panels	24 1/2"	24 1/2"	42 1/2"			\$ 756	End & Intermediate Panels: Panel frame construction consists of 1-1/4" x 1-1/4", 16 gauge steel tube framed on all four sides and an extra vertical tube at the front edge creating a double bar open framed concept. Metal Low Back shelves adjust on 1" increments. All metal parts and components are finished in a powder epoxy, thermal enamel finish.	
VE-BA4820E				48 1/2"			\$ 781		
VE-BA6020E				60 1/2"			\$ 894		
VE-BA7220E				72 1/2"			\$ 950		
VE-BA8420E				84 1/2"			\$ 981		
VE-BA9620E				96 1/2"			\$ 1,006		
VE-BA4224E				28 1/2"			42 1/2"		\$ 763
VE-BA4824E				28 1/2"			48 1/2"		\$ 794
VE-BA6024E				28 1/2"			60 1/2"		\$ 900
VE-BA7224E				28 1/2"			72 1/2"		\$ 963
VE-BA8424E	28 1/2"	84 1/2"	\$ 994						
VE-BA9624E	28 1/2"	96 1/2"	\$ 1,013						
VE-BA4228E		33 1/2"	33 1/2"	42 1/2"			\$ 775	Acrylic screen Insert Option: Frosted acrylic is 1/4" thick positioned in the open frame portion of End Panels. Images shown are to demonstrate the finished product with the acrylic screen insert option and are not the standard product. Please inquire with Palmieri for pricing.	
VE-BA4828E				48 1/2"			\$ 800		
VE-BA6028E				60 1/2"			\$ 913		
VE-BA7228E				72 1/2"			\$ 975		
VE-BA8428E				84 1/2"			\$ 1,000		
VE-BA9628E				96 1/2"			\$ 1,025		
VE-BA4220M				Double Face Bolt Assembly Mid Panels			24 1/2"		24 1/2"
VE-BA4820M	48 1/2"	\$ 831							
VE-BA6020M	60 1/2"	\$ 938							
VE-BA7220M	72 1/2"	\$ 1,000							
VE-BA8420M	84 1/2"	\$ 1,031							
VE-BA9620M	96 1/2"	\$ 1,050							
VE-BA4224M	28 1/2"	42 1/2"	\$ 813						
VE-BA4824M	28 1/2"	48 1/2"	\$ 838						
VE-BA6024M	28 1/2"	60 1/2"	\$ 950						
VE-BA7224M	28 1/2"	72 1/2"	\$ 1,013						
VE-BA8424M	28 1/2"	84 1/2"	\$ 1,088						
VE-BA9624M	28 1/2"	96 1/2"	\$ 1,063						
VE-BA4228M		33 1/2"	33 1/2"	42 1/2"			\$ 819		
VE-BA4828M				48 1/2"			\$ 850		
VE-BA6028M				60 1/2"			\$ 956		
VE-BA7228M				72 1/2"			\$ 1,019		
VE-BA8428M				84 1/2"			\$ 1,050		
VE-BA9628M				96 1/2"			\$ 1,069		

Palmieri Furniture Limited ("Palmieri") warrants that its products and collections are free from defects in materials and workmanship for the life of the product, except as set forth below. Palmieri Limited Lifetime Warranty is valid from the date of delivery.

Exceptions to the Limited Lifetime Warranty: Seating: two (2) years

Goods sold hereunder are covered by a Limited Lifetime Warranty, free against defects in material and workmanship provided the goods and services are subjected to normal use and service. The applicable warranty period commences from shipping date to Purchaser of any item of the goods, whichever occurs first, or any other warranty period otherwise stipulated in writing by Palmieri under this sale. For components not supplied by Palmieri, the original manufacturer's warranty shall apply to the extent assignable by Palmieri. The obligation under this warranty is limited to the repair or replacement, at Palmieri's option, of defective parts F.O.B. point of shipment provided that prompt notice of any defect is given by Purchaser to Palmieri in writing within the applicable warranty period and that upon the Purchaser's return of the defective parts to Palmieri or, if designated by Palmieri, to the location where the works are made, properly packed and with transportation charges prepaid by Purchaser, an inspection thereof shall reveal to Palmieri's satisfaction that Purchaser's claim is valid under the terms of this warranty. Purchaser shall assume all responsibility and expense for dismantling, removal, re-installation and freight in connection with the foregoing. The same obligations and conditions extend to replacement parts furnished by Palmieri hereunder.

Palmieri does not assume liability for installation, labour or consequential damages. Palmieri makes no warranty other than the one set forth herein. All other warranties, legal, expressed or implied, including but not limited to any expressed or implied warranty of merchantability, of fitness for the intended use thereof or against infringement are hereby expressly excluded. The applicable warranty ceases to be effective if the goods are altered or repaired other than by persons authorized or approved by Palmieri to perform such work. Repairs or replacement deliveries do not interrupt or prolong the term of the warranty. The warranty ceases to be effective if Purchaser fails to handle and use the goods sold hereunder in a safe and reasonable manner and in accordance with any written instructions from the manufacturers.

Warranty Does Not Apply To Product Failure Or Loss Resulting From:

Abuse, misuse or accident, alteration or modification of product by customer or third party, normal wear and tear, improper installation, handling or incorrect use. The substitution of part components or hardware not approved or authorized by Palmieri, acts of God, unauthorized repairs, improper storage, and environmental conditions such as irregular temperature control either inside or outside the environment.

Warranty Provides Exclusive Remedies:

If a product fails under ordinary use as a result of a defect in material or workmanship, Palmieri will: (A) repair, or (B) replace the furniture. The replacement or repair of the Furniture or Seating will be at the discretion of Palmieri. If the defect or workmanship cannot be remedied on site, repairs can be made at the factory. (C) If the product repair or replacement is not commercially practicable or cannot be remade in a timely manner Palmieri will refund the purchase price of the affected product. A product "**Defect**" means: an inadequacy in the materials or workmanship of the product that (A) existed at the time when you received the product from Palmieri or Palmieri authorized Reseller and (B) causes a failure of the product to perform under ordinary use in accordance with the materials and documentation accompanying the product. "**Ordinary Use**" means: use of the product (A) in accordance with all applicable local, state or federal laws, codes and regulations and (B) in accordance with manufacturer recommendations and or instructions in the materials and documentation accompanying the product or through shop drawings. A "**Palmieri Authorized Reseller**" means: any dealer that is legally permitted to conduct business in the jurisdiction where the product is sold and is duly authorized by Palmieri to sell the product.

Warranty work must be approved by authorized personnel of Palmieri Furniture Limited in Richmond Hill, Ontario, Canada.

A copy of the original purchase order must accompany all claims.

Warranty Does Not Cover:

Matching of colours, stains, textures, grains and any other variations in materials. Select and Custom Surfaces and materials are only warranted for their application on the specified product and are not covered by our warranty, except as warranted by the original supplier, for quality, colorfastness, shade variations or abrasion and textiles purchased for Palmieri product.

This limited warranty is the sole remedy for product defect and no other express or implied warranty is provided. Warranty is not transferable and valid only for the original purchaser acquiring a product from Palmieri or a Palmieri authorized reseller for the purchaser's own use and not for resale, remarketing or distribution. Limited Lifetime Warranty (25 years)

GENERAL

The following Terms and Conditions of Quote and Sale shall apply to any sale of goods and services by Palmieri Furniture Limited (hereinafter called "Palmieri"). Purchaser shall be deemed to have full knowledge of the terms and conditions herein and such terms and conditions shall be binding if either the goods and services referred to herein are delivered to and accepted by Purchaser, or if Purchaser does not within five (5) days from the date hereof deliver to Palmieri written objection to said terms and conditions or any part thereof.

In the event of any conflict or inconsistency between the terms and conditions of sale herein and the terms and conditions contained in Purchaser's order or in any other form issued by Purchaser, whether or not any such form has been acknowledged or accepted by Palmieri, Palmieri's terms and conditions herein shall prevail. No waiver, alteration or modification of these terms and conditions shall be binding upon Palmieri unless made in writing and signed by a duly authorized representative of Palmieri.

1. QUOTATIONS / PRODUCT QUOTED

Unless otherwise stated, **Palmieri's quotations shall be null and void unless accepted by Purchaser within thirty (30) days from the date of quotation.** Quotes may be subject to change before order placement, due to increased material costs and or other factors that could impact the final cost of production and our final understanding of the product required. If the items quoted do not reflect the intended product requirements of the customer, Palmieri will not be held responsible for increased costs for those product changes. We reserve the right to edit or re-quote any portion of a previously submitted quotation subject to our final understanding of the product required by the client.

2. PALMIERI DRAWINGS

Palmieri provides drawings for Custom & Standard product we produce to our clients upon request. We consider these drawings to be Private and Confidential and are provided for the sole purpose and use of our clients to understand the product we are providing. The use of these confidential materials is limited to the transaction between the parties and at no point are these confidential materials to be sent to any of our competitors or parties quoting for the same purpose.

A minimum \$85.00 NET Engineering Administrative Fee will apply for Custom Product Drawings

(Note: The first set of Custom product drawings will be free of charge)

A minimum \$120.00 NET Engineering Administrative Fee will apply for all Standard Product Drawings

3. TERMS OF PAYMENT

For authorized customers; Orders at a \$75,000.00 threshold will require a mandatory 25% deposit. Orders over and above \$100,000.00 requires a mandatory (25%) deposit at time of order, a mandatory (25%) deposit prior to product shipment and the balance to be paid within thirty (30) days of date of shipment. Payment not be made to Palmieri when due, Palmieri reserves the right to charge Purchaser with interest on such overdue payments. Interest of 2% per month (24% per annum) is charged on all overdue accounts, unless otherwise specified. The charging of such interest shall not be construed as obligating Palmieri to grant any extension of time in the terms of payment. All goods remain the property of Palmieri, until balance is paid in full to Palmieri.

4. TITLE

Title to the goods or any part thereof shall not pass from Palmieri to Purchaser until all payments due hereunder have been duly made, except as otherwise expressly stipulated herein. The goods shall be and remain personal or moveable property, notwithstanding their mode of attachment to realty or other property. If default is made in any of the payments herein, Purchaser agrees that Palmieri may retain all payments which have been made on account of the purchase price as liquidated damages, and Palmieri shall be free to enter the premises where the goods may be located and remove them as Palmieri's property, without prejudice to Palmieri's right to recover any further expenses or damages Palmieri may suffer by reason of such nonpayment.

5. TAXES

Prices do not include Goods & Services Tax, Provincial or Municipal sales, use, value-added or similar tax. All applicable taxes are extra. Our Harmonized Sales Tax (HST) registration number is R104055066.

6. THE AGREEMENT

An acceptance and official confirmation of Purchasers' order by signing Palmieri's Order Confirmation the Purchaser therefore is accepting terms and conditions as expressed herein Palmieri's Terms and Conditions of Quote and Sale by Palmieri and shall constitute the complete agreement, subject to the terms and conditions of sale herein set forth, and shall supersede all previous quotations, orders or agreements.

7. LEAD TIME / DELIVERY / DELAYS

Lead time is determined only when final material/finish selection and drawing approvals are received by Palmieri from the client. The accuracy of Palmieri's lead times, is created to the best of our ability with the information provided to us. Confirmed lead time is conveyed to the client by means of Order Confirmation. They do not preclude the client from checking the accuracy of your requirement and our Order Confirmation. Any noted discrepancies are to be reported immediately to Palmieri Customer Service Department for correction and re-issue of revised Order Confirmation. By signing and dating the Order Confirmation the client accepts the terms and conditions of quote and sale.

Lead time on our Order Confirmation do not account for delays that could potentially occur for special materials specified by the client that are outside of our standard finishes and materials program that are out of our control

and will affect the lead time on the order. Palmieri will notify the client immediately when these delays occur and adjust the lead time accordingly.

Delivery schedules are approximate and are based on prevailing market conditions applicable respectively at the time of Palmieri's quotation and Palmieri's acceptance of clients' order, if certain portions of an order are completed by the quoted lead time while other portions have experienced delays outside of our control. The client may choose to part ship the order at their discretion and expense. Otherwise the entire order will ship with the delayed portion at a later date. Palmieri may extend delivery schedules or may, at its option, cancel Purchaser's order in full or in part without liability other than to return any deposit or prepayment which is unearned by reason of the cancellation.

8. CHANGES AND CANCELLATION

Orders accepted by Palmieri are not subject to changes or cancellation by Purchaser without the written consent of Palmieri. In such cases where Palmieri authorizes changes or cancellation, Palmieri reserves the right to charge the Purchaser with reasonable costs based upon expenses already incurred and commitments made by Palmieri, including, without limitation, any labour done, material purchased and also including Supplier's usual overhead and reasonable profit and cancellation charges from Palmieri's suppliers. Palmieri will communicate to the Purchaser additional costs incurred by way of Revised Order Confirmation. Revised Order Confirmation will include applicable costs incurred and modification to lead times (if applicable). The Purchaser must provide Palmieri written confirmation of additional costs, before any changes can be processed on the order.

A minimum charge of \$100.00 NET Change Order Request fee will apply

A minimum charge of \$150.00 NET Cancel Order Request fee will apply.

9. SHIPPING LOCATION / SHIPPING QUOTES / COST OF TRANSPORTATION

Unless otherwise stated, all prices are F.O.B. our factory in Richmond Hill, Ontario, Canada.

Customary methods of transportation shall be selected by Palmieri and such transportation will be at Purchaser's expense. Shipping quotations are made at time of furniture quotation and are outside the control of Palmieri. **Shipping quotes are valid for ten (10) business days from the time of quote.** We do our best to maintain shipping costs as quoted, however all shipping weights and cubic feet shown are approximate only, various construction materials and packaging methods may add to the weights given. All quoted prices, unless otherwise stated on the quotation, are based on the current exchange rates, tariffs, fuel surcharges and costs of manufacture and are subject to change by Palmieri with or without notice until Purchaser's acceptance. Palmieri does not assume responsibility or liability for shipping costs, product during transit, or variances from the shipping weights or cubic feet shown in our specification guides. Special methods of transportation will be used upon Purchaser's request and at Purchaser's additional expense, provided reasonable notice of Purchaser's transportation requirements are given by Purchaser to Palmieri prior to shipment. Palmieri will notify the client prior to shipping product if shipping costs as quoted change, at which point the client must approve the adjusted shipping costs.

10. RECEIVING PRODUCT / REPORTING DAMAGE / STORAGE OF PRODUCT

Upon receipt of Palmieri product, the receiver of the goods must immediately inspect the product to ensure it is free of shipping damage. If the product is deemed in good order, the receiver of the product must ensure

to sign off on the accompanying carriers Bill of lading in good condition. Except for obligations stated under "Warranty" herein, Palmieri's responsibility for the product ceases once the product has been received and signed off in good order and is the full responsibility of the receiver and subsequently the owner.

In the event shipping damage is discovered during receipt of shipment, it is the responsibility of the receiver to ensure all noted damage is recorded on the carrier's Bill of Lading prior to sign off. All noted shipping damage claims must be reported to Palmieri within **24 hours** of receipt of the product onsite, failure to do so will result in the claim being deemed null and void. All shipping damage claims are to be reported directly to Palmieri's Shipping Manager. Please call our toll free number at **1-800-413-4440 ext. 33** or submit the claim by Fax directly to **1-905-731-9878**. Palmieri will not accept any shipping damage claims submitted **after 24 hours** and it shall be conclusively presumed that the goods were delivered in good condition.

Storage of product, Palmieri will not be held responsible for any potential damages or shortages for product shipped and received by Purchaser and is subsequently placed into storage and not inspected within 24 hours of receipt.

11. INSTALLATION / SHORTAGES / BACK CHARGES

Unless otherwise expressly stipulated, the goods shall be installed by and at the risk and expense of Purchaser.

In the event that Palmieri is requested to supervise such installation, Palmieri's responsibility shall be limited to exercising that degree of skill customary in the trade in supervising installations of the same type. Purchaser shall remain responsible for all other aspects of the work including compliance with the local regulations. It is the responsibility of the Purchaser to ensure hardware and parts are received in good order. Packing slip and hardware list to be provided by Palmieri with every order at time of shipping. Purchaser has the responsibility to notify Palmieri immediately without delay of issues that arise; subsequently Palmieri will take action to provide prompt resolution.

Shortages must be reported to Palmieri within **24 hours** of receipt of the goods and failure to do so may be at the expense of the Purchaser.

If deemed missing hardware and parts short shipped from the factory, Palmieri will arrange to ship freight prepaid to destination. Palmieri will only be responsible for replacement costs of missing hardware and parts, any labour costs incurred will be the responsibility of the Purchaser and will not be approved by Palmieri.

Back Charges will only be approved if we deemed a defect in the material or workmanship is found during the installation period resulting in a return trip to the job-site to complete installation. It shall remain the sole discretion of Palmieri to approve (A) repair or (B) replace the furniture and any labour costs incurred by the Purchaser.

12. FORCE MAJEURE

Palmieri shall not be responsible or liable for any loss or damage incurred by Purchaser herein resulting from causes beyond the reasonable control of Palmieri including, but without limitation, abuse, misuse or accident, alteration or modification of product by customer or third party, normal wear and tear, improper installation, handling or incorrect use, unauthorized repairs, the substitution of part components or hardware not approved or authorized by Palmieri, improper storage, and environmental conditions such as irregular temperature control

either inside or outside the environment, acts of God, fire, flood, delays in transportation, or the failure of Palmieri's suppliers to meet their delivery promises. The acceptance of delivery of the goods by Purchaser shall constitute a waiver of all claims for loss or damage due to any delay whatsoever.

13. RETURNED GOODS

No goods may be returned to Palmieri for a credit or exchanged without Palmieri's prior written consent.

Palmieri reserves the right to accept all returns and subject to a handling/restocking charge or to decline all returns. Even after Palmieri has authorized the return of goods for credit, Palmieri reserves the right to adjust the amount of any credit given to Purchaser on return of the goods based on the conditions of the goods on arrival in Palmieri's warehouse. Credit for returned goods will be issued to Purchaser only where such goods are returned by Purchaser and not by any subsequent owner of the goods. Goods will be considered for return only if they are in their original condition and packaging. Palmieri Goods Return Authorization Form to be issued and **must** accompany all shipments returning back to the factory. **Return freight must be prepaid by Purchaser. A minimum 20% re-stocking fee will apply.**

1230 Reid Street
Richmond Hill
Ontario Canada
L4B 1C4

T 905 731 9300
F 905 731 9878
TF 800 413 4440

info@palmierifurniture.com
www.PalmieriFurniture.com

SPECIFICATION GUIDE & PRICE LIST

2017









PALMIERI











PALMIERI SOCIAL MEDIA[®]

Design: Mark Müller







CATEGORY: LIBRARY FURNITURE

CONTRACT: BID #ESCNJ 17/18-16

Introduction	1
Table of Contents	2-5
Product Materials	6-9
Fabric Finishes	10-17
SM1 TABLES	18-19
 SM1-1 Offset Column	18
 SM1-2 Center Column	18
 SM1-3 Double Column	18
SM2 TABLES	20-21
 SM2-1 Fixed Height	20
 SM2-2 Adjustable Height	20
SM3 TABLES AND BENCHES	22-47
 SM3 Table Top and Upholstered Seats	22
 SM3-01 Single Bench - Closed	24
 SM3-02 Single Bench - 1 Open Side	26
 SM3-03 Single Bench - 2 Open Ends	28

 SM3-04 Table	30
 SM3-10 Double Bench - 1 Open Side with Divider	32
 SM3-11 Double Bench - Offset Open Side, Opposite Sides	34
 SM3-12 Double Bench - 1 Open Side, 1 Open End	36
 SM3-13 Double Bench - 1 Open Side, 2 Open Ends	38
 SM3-20 Quad Bench - 2 Open Sides with Dividers	40
 SM3-21 Quad Bench - Offset Open Side, Opposite Sides	42
 SM3-22 Quad Bench - 2 Offset Open Sides, 2 Offset open Ends	44
 SM3-23 Quad Bench - 2 Open Sides, 2 Open Ends	46
SM4 TABLES	48-49
 SM4-1 Fixed Height	48
 SM4-2 Adjustable Height	48

SM5 MEDIA CENTERS 50-61

	SM5-TS Standard Top	50
	SM5-TB Bullet Top	52
	SM5-TR Round Top	54
	SM5-2-TS Short Back - Standard Top	56
	SM5-2-TB Short Back - Bullet Top	58
	SM5-2-TR Short Back - Round Top	60

Electrical	62
Warranty	64
Terms & Conditions	65

WOODS & FINISHES:

Natural Maple

Standard

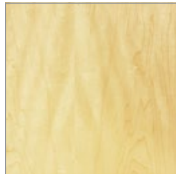

Natural Clear – M-NA

Maple Finishes

The following stains are available, add 10% to list

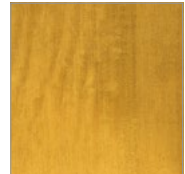

Castle Oak – M-CO



Honey Oak – M-HO

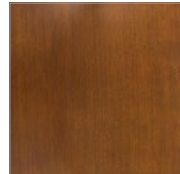

English Oak – M-EN

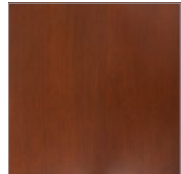

Victorian Cherry – M-VI



Richmond Cherry – M-RC

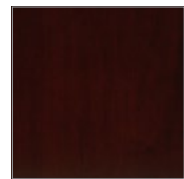

Mahogany – M-MA



Java – M-JA



Wenge – M-WE

Natural Red Oak

Standard

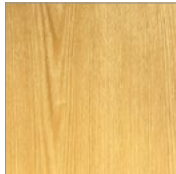

Natural Clear – O-NA

Red Oak Finishes

The following stains are available, add 10% to list

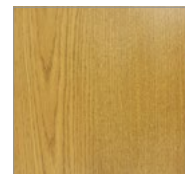

Castle Oak – O-CO



Honey Oak – O-HO

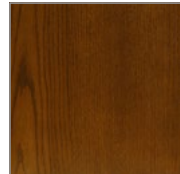

English Oak – O-EN



Victorian Cherry – O-VI

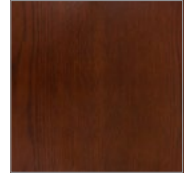

Richmond Cherry – O-RC



Mahogany – O-MA



Java – O-JA



Wenge – O-WE

Natural Cherry

Add 20% to list

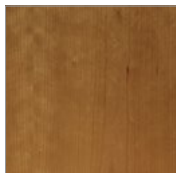

Natural Clear – C-NA

Cherry Finishes

The following stains are available, add 30% to list



Honey Oak – C-HO



Richmond Cherry – C-RC

Natural Walnut

Add 20% to list

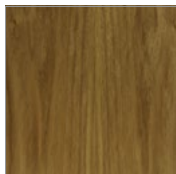

Natural Clear – W-NA

Walnut Finishes

The following stain is available, add 30% to list



Java – W-JA

WILSONART® LAMINATES:

Solid, Abstract and Wood Grain Options



Frosty White
1573-60



Black
1595-60



Island
D498-60



Blue Agave
4919-60

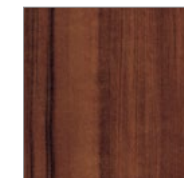

Mambo
7948-60



Grey Elm
8201-38



Natural Almond
D30-60



Indigo
D379-60



Hunter Green
D79-60

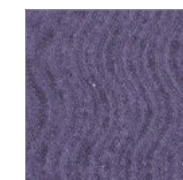

Eggplant
4913-60

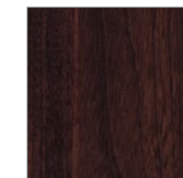

Cocobala
7942-38

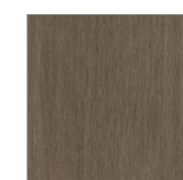

Phantom Cocoa
8213-38



Beige
1530-60



Sunshine
D499-60



Ocean
D502-60

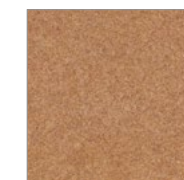

Spiced Zephyr
4859-60

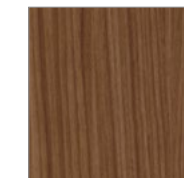

Walnut Heights
7965-38

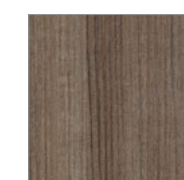

Studio Teak
7960-38



Fashion Grey
D381-60



Orange Grove
D501-60



Lapis Blue
D417-60



Morro Zephyr
4846-60

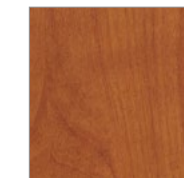

Wild Cherry
7054-60



Skyline Walnut
7964-38



Dove Grey
D92-60



Hollyberry
D307-60



Maroochy Brush
4745-60



Fusion Maple
7909-60



Phantom Pearl
8211-38



Phantom Charcoal
8214-38



Slate Grey
D91-60



Port
D14-60



Woolamai Brush
4746-60

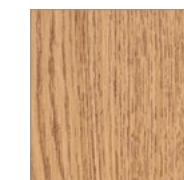

Bannister Oak
7806-60



White Driftwood
8200-38



Asian Night
7949-38

METAL PAINT:

Thermal Paint Colours

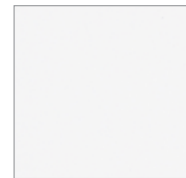

White
PS-111-W374



Antique White
W11



Beige
H23

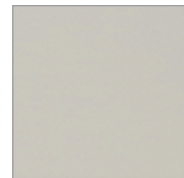

Desert
H432

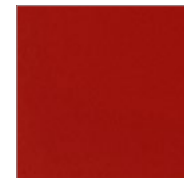

Red
R66



Ruby
R7



Blue
B11



Navy
B17

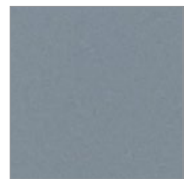

Zinc
A67



Hydro Green
G96



Green
G58

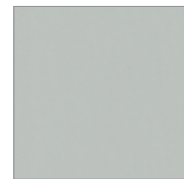

Grey
A16



Charcoal
A230



Black
N49



Pebble
M237

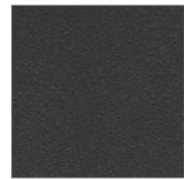

Black Sandtex
N31



Sparkling Silver
S11

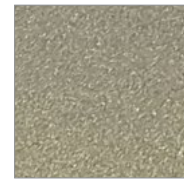

Champagne
S14

HARDWOODS: All hardwood materials used in the manufacturing of Palmieri products shall be Northern grown hardwoods. Hardwoods will be air and kiln dried to a moisture content of 5-7%. All hardwoods shall be of grade "A" material, free of material stains, imperfections, conformity of grain, texture and color. Hardwood species shall be Northern grown Red Oak, Clear White Northern Maple and Birch. American Cherry and Honduras Mahogany and Walnut are available. Please inquire for pricing.

VENEER: Exposed face veneers shall be not less than 1/28" thick plain sliced veneers. Veneers are to be selected for conformity of grain direction and color. Veneers are to be stitched tightly in a book match, slip match or plain sliced configuration. Unexposed veneers are to be of hardwood but not selected for color, or grain quality. Veneers are not to be lap joined or reveal any tape or glue lines.

PARTICLE BOARD CORE: The particleboard shall be formed of wood chips, bonded with a water resistance adhesive. The particleboard material is to be of a high density 45 lbs/cu. ft. having a minimum average modulus of rupture of 2400 psi and a minimum average modulus of elasticity of 4,000,000 psi.

VENEER CORE: Veneer core is to be constructed with odd numbers of plies. Each ply is to be laminated in pairs and cross banded in opposite directions with grain direction at a 90 degree angle to the grain of the center core. All plies are to be free from knots, wrinkles, laps or other natural or manufacturing defects.

LUMBER CORE: Lumber core is to be of the highest quality grade. Grade "A" select stock. Lumber core shall be constructed of solid random width strips not less than 2" wide nor more than 3 1/2" wide by 1" thick. Wood strips will be free from knots or other defects. All strips will be tightly joined using water resistance adhesives.

HIGH PRESSURE LAMINATE: Work surface laminate shall be .050" thick and used with balancing backer sheet of no less than .028" thick. Laminate shall conform to standards set by the American Standards Institute/National Electrical Manufacturers Association (ANSI/NEMA) for thickness, performance and appearance. Printed colours, abstract patterns and wood grains are reproduced from representative segments of large sheets and may differ slightly from the actual product.

FINISHING PROCEDURES: All materials shall be inspected and treated with a final sanding and polishing operation before any staining and final finishing can be performed. All machine and mill marks are to be removed. Once the polishing and sanding has been performed, the furniture will then undergo the following stain and finishing procedures:

- Step 1 A base stain will be uniformly applied, wiped and then allowed to dry under factory controlled conditions.
- Step 2 A uniform coat of sealer will be applied and allowed to dry.
- Step 3 Sealer will be lightly sanded using 240 grit silicon paper.
- Step 4 A catalytic lacquer of 34-45 degree sheen is evenly applied and allowed to dry under factory controlled conditions.

METAL FINISHING PROCEDURES: All metal components are thoroughly cleaned and coated electrostatically with an epoxy powder coat paint finish. The metal components are then oven baked and cured for a lasting finish.



Red 14

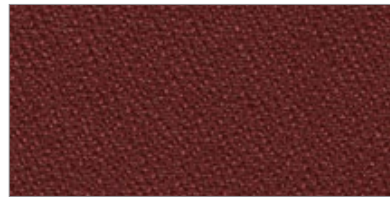

Burgundy 108



Terracotta 405



Gold 59



Eucalyptus 64

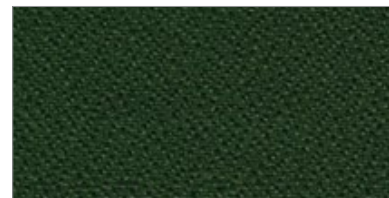

Green 208

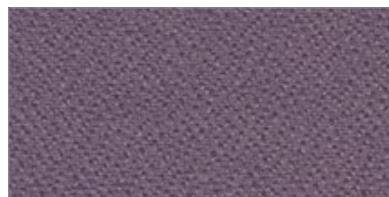

Purple 1009



Mist 32

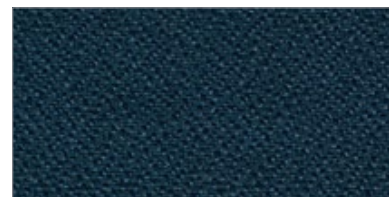

Navy 308

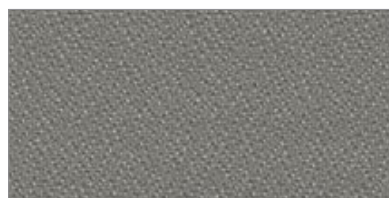

Charcoal 908



Black 9009

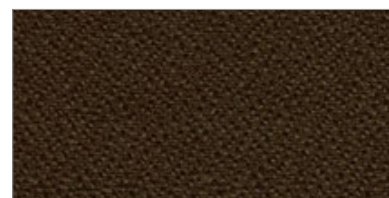

Brown 87

CORNERBLOCK FABRIC SPECIFICATION:

Abrasion: Exceeds 420,000 Double Rubs.

Backing Content: 100% Acrylic

Cleaning Instruction: Solvent Cleaner.

Colors Available: 12 colors available.

Construction: Crepe

Content: 100% Polyester

Crocking: AATCC 8: Dry = Class 4.5 AATCC 8: Wet = Class 4.5

Description: Solid Crepe: Contract Rated

Fire Retardancy: California Bulletin 117-Section E, Motor Vehicle Safety Standard 302. NFPA 260 Class 1. UFAC Class 1

Pilling: Passes ASTM D3511 - Class 4.5

Protective Finish: Stain and Soil Resistant Finish

Railroaded Pattern: Non-Directional

Seam Slippage: Passes Seam Slippage ASTM D4034.W 61 x F 66 LBF

Tear Strength: Passes ASTM D2261 - Warp = 54 lbs and Fill = 72 lbs.

Tensile Strength: Passes ASTM D5034 - Warp = 491 lbs and Fill = 364 lbs.

Ultraviolet: LIGHTFASTNESS IS 40 HOURS Colorfastness to Light AATCC16 Class 4.5

Weight: 11.06 ounces per square yard. 17.51 Ounces per Linear Yard

*To request large individual Sample Colors please visit www.jennisfabrics.com



Fawn 67



Radiant Orchid 102



Lilac 105



Rosewood 108



Linen 608



Beaver 808

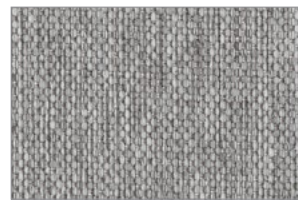

Wind Chime 905



Mud 908



Denim 3006



Zantium 3009



Old Gold 4009



Buff 6009



Coffee 8009



Steel 9003



Licorice 9009

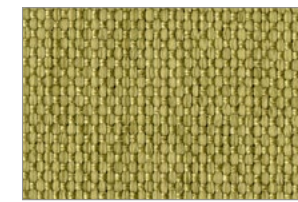

Hemlock 202



Air 3003



Saddlewood 8006

FOUNDATION FABRIC SPECIFICATION:

Abrasion: Exceeds 100,000 Double Rubs.

Backing Content: 100% Polyester

Cleaning Instruction: WC - Wash with care.

Colors Available: 18 colors available.

Content: 100% Polyester

Crocking: AATCC 8: Dry 4.5, Wet 4.5

Fire Retardancy: California (CAL) Bulletin 117-Section E, UFAC Class 1t

Pilling: ASTM D3511: Class 4.5

Seam Slippage: ASTM D4034: Warp = 64 lbs. and Fill = 70 lbs.

Tear Strength: ASTM D2261: Warp = 36 lbs. and Fill = 24 lbs.

Tensile Strength: ASTM D5034: Warp = 335 lbs and Fill = 168 lbs.

Ultraviolet: Colorfastness to Light AATCC16 Class 3

Weight: 11.21 ounces per square yard. 17.75 ounces per linear yard.

*To request large individual Sample Colors please visit: www.jennisfabrics.com

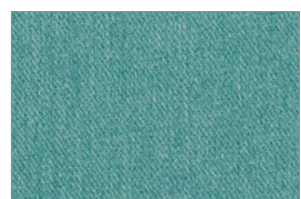

Seabreeze 34

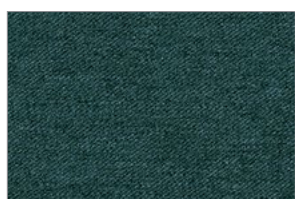

Gunmetal 37

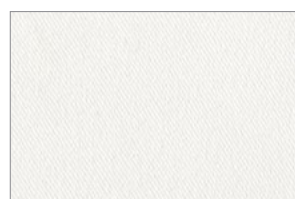

Ivory White 62

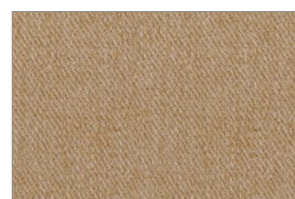

Buff 67



Army Brown 85



Ash 92



Steel 97



Cotton Candy 102

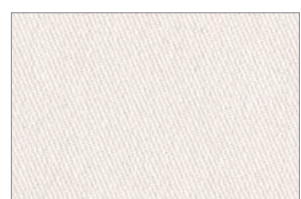

Ivory 602



Tuscan Tan 802



Latte 806



Earth Grey 902



Charcoal 908



Violet 1009



Dazzling 3003

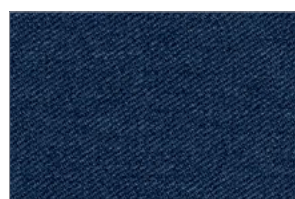

Denim 3006

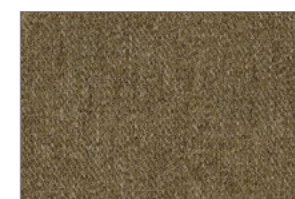

Camel 81



Acid Wash 305



Rich Grey 904



Cinnamon Brown 8006

JOURNEY FABRIC SPECIFICATION:

Abrasion: Exceeds 125,000 Double Rubs.

Backing Content: 100% Acrylic

Cleaning Instruction: MWC - Machine Wash with care.

Colors Available: 20 colors available.

Content: 100% Polyester

Crocking: AATCC 8: Dry 4.5, Wet 4.5

Fire Retardancy: California (CAL) Bulletin 117-Section E, UFAC Class 1.

Pilling: ASTM D3511: Class 4.5

Seam Slippage: ASTM D4034: Warp = 135 lbs. and Fill = 130 lbs.

Tear Strength: ASTM D2261 - Warp = 20 lbs and Fill = 17 lbs..

Tensile Strength: ASTM D5034: Warp = 295 lbs and Fill = 194 lbs.

Ultraviolet: Colorfastness to Light ASTM D3597-02(2013)-Fading 5.0 - 40 hours

Weight: 9.74 ounces per square yard. 14.88 ounces per linear yard

*To request large individual Sample Colors please visit www.jennisfabrics.com



White 3822



Vanilla 61



Cream 6003



Parchment 605



Sandstone 608



Mocha 808



Bisque 805



Earth 84



Chestnut 87



Chocolate 8020



Chinchilla 6009



Black 9009



Steel 905



Lagoon 37



Pacific Blue 3003



Navy 3006



Plum 1009



Citron 54



Sprig 205

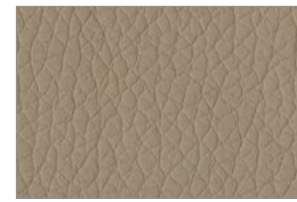

Taupe 3948



Tan 802



Brick 11



Wine 108



Grey 9003



Quicksilver 95



Rust 14



Garnet 17

TURNER VINYL SPECIFICATION:

Abrasion: Exceeds 500,000 Double Rubs.

Backing Content: 30% Cotton 70% Polyester

Cleaning Instruction: Water/Solvent Based Cleaner. Do not bleach

Cold Crack: Product Cold Crack is equal to or greater than -40 degrees Celsius (-40 Fahrenheit)

Colors Available: 26 colors available.

Construction: Vinyl

Content: 100% Polyurethane (PU)

Description: Simulated Leather Vinyl, Contract Rated

Eco Friendly: Eco-Friendly

Elongation: ASTM D5034: Warp: 23.4%, Fill: 38.1 %

Features: Phthalate Free Wipe with a soft cloth, with cold water and a mild soap. Dry immediately. PVC Free

Fire Retardancy: California Bulletin 117-Section E, Motor Vehicle Safety Standard 302. NFPA 260 Class 1. UFAC Class 1

Seam Slippage: Passes ASTM D751 - Warp = 116 lbs and Fill = 90 lbs.



Tear Strength: Passes ASTM D2261 - Warp = 20 lbs and Fill = 12 lbs.

Tensile Strength: Passes ASTM D5034 - Warp = 105 lbs and Fill = 74 lbs.

Ultraviolet: Colorfastness to Light AATCC16 Class 4.5



Weight: 14.12 ounces per square yard. 21.18 Ounces per Linear Yard

*To request large individual Sample Colors please visit www.jennisfabrics.com

	MODEL NUMBER	PRODUCT	WIDTH	DEPTH	HEIGHT	WEIGHT	VOLUME	LIST PRICE	DESCRIPTION
	SM1-1-W	Wood Veneer Top	16"	20"	23 ³ / ₄ "			\$ 1,000	<p>TOP: Constructed of 1/2" thick high density particleboard core with plastic laminate or wood veneer. Profile edge consists of an internal solid hardwood with a 3/8" radius from underside and a soft radius profile top.</p> <p>METAL BASE: Base consists of one or two 1" diameter solid steel column with upper and lower taper bushings. Steel base is 3/16" thick with soft radius corners.</p>
	SM1-1-L	Laminate Top	16"	20"	23 ³ / ₄ "			\$ 900	
	SM1-2-W	Wood Veneer Top	16"	20"	23 ³ / ₄ "			\$ 1,006	
	SM1-2-L	Laminate Top	16"	20"	23 ³ / ₄ "			\$ 906	
	SM1-3-W	Wood Veneer Top	16"	36"	23 ³ / ₄ "			\$ 1,675	
	SM1-3-L	Laminate Top	16"	36"	23 ³ / ₄ "			\$ 1,581	

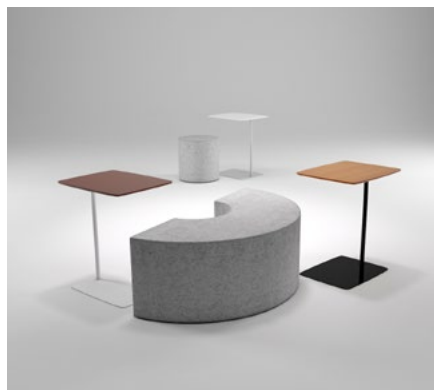
SM1 Layout Options



	MODEL NUMBER	PRODUCT	WIDTH	DEPTH	HEIGHT	WEIGHT	VOLUME	LIST PRICE	DESCRIPTION
		FIXED HEIGHT							
	SM2-1-W	Wood Veneer Top	37 1/2"	24"	29"			\$ 1,981	<p>TOP: Constructed of 1" thick high density particleboard core with plastic laminate or wood veneer. Profile edge consists of an internal solid hardwood with a 3/4" radius from underside and a tapered profile top.</p> <p>FIXED METAL BASE: Base consists of a 2 1/2" diameter tubular 16 gauge steel column and the steel base is 3/16" thick with a tapered profile.</p> <p>ADJUSTABLE METAL BASE: Base consists of 2 1/2" diameter tubular 16 gauge steel pneumatic lift column and the steel base 3/16" thick with a tapered profile.</p>
SM2-1-L	Laminate Top	37 1/2"	24"	29"			\$ 1,900		
		ADJUSTABLE HEIGHT							
	SM2-2-W	Wood Veneer Top	37 1/2"	24"	27" to 42 1/2"			\$ 4,863	
	SM2-2-L	Laminate Top	37 1/2"	24"	27" to 42 1/2"			\$ 4,781	

SM2 Layout Configuration











MODEL NUMBER	PRODUCT	WIDTH	DEPTH	HEIGHT	WEIGHT	VOLUME	LIST PRICE	DESCRIPTION
	TABLE TOP AND UPHOLSTERED SEATS							
	SM3-W Wood Veneer Top Upholstered Seat with (2) Electrical	100"	37"	27 ³ / ₄ "			\$ 13,775	<p>TOP: Constructed of ³/₄" thick high density particleboard core with plastic laminate or wood veneer. Profile edge consists of an internal solid hardwood with a ³/₈" radius from underside and a soft radius profile top. Work surface top is 16" deep x 37" wide x 27³/₄" high.</p>
SM3-L	Laminate Top Upholstered Seat with (2) Electrical	100"	37"	27 ³ / ₄ "			\$ 13,719	<p>BENCH SEATING: Constructed from 1" high density particleboard core with grade 'A' face veneers. Each bench position consists of an open cubby 9³/₄" deep x 38" wide x 10¹/₄" high. Each upholstered bench seat is 18" deep x 40" wide x 17³/₄" high.</p> <p>ELECTRICAL: PW-100-MT electrical unit consisting of (1) outlet and (2) USB ports located on the side.</p> <p>FURNITURE LEGS: Legs are 4" high, polished chrome designer series with a rubber glide.</p>





SM3 & SM1 Collaboration Usage





UPHOLSTERED SEATS:
SM-3 Benches are available in a large selection of Contract grade fabrics; Cornerblock, Foundation, Journey Fabrics or Turner Vinyl is also available as an upcharge.

	MODEL NUMBER	PRODUCT	WIDTH	DEPTH	HEIGHT	WEIGHT	VOLUME	LIST PRICE	DESCRIPTION
	SM3-01-W	SINGLE BENCH - CLOSED Veneer Surface with No Electrical	30"	18"	16 ³ / ₄ "			\$ 4,281	<p>BENCH SEATING: Constructed from 1" high density particleboard core with grade 'A' face veneers.</p> <p>ELECTRICAL: PW-100-MT electrical unit consisting of (1) outlet and (2) USB ports located on the side.</p> <p>FURNITURE LEGS: Legs are 4" high, polished chrome designer series with a rubber feet.</p>
	SM3-01-W-EL	Veneer Surface with (2) Electrical	30"	18"	16 ³ / ₄ "			\$ 5,231	<p>UPHOLSTERED SEATS: SM-3 Benches is available in a large selection of Contract grade fabrics; Cornerblock, Foundation, Journey Fabrics or Turner Vinyl also available as an upcharge.</p>
	SM3-01-U	Upholstered Seat with No Electrical	30"	18"	17 ³ / ₄ "			\$ 4,806	
	SM3-01-U-EL	Upholstered Seat with (2) Electrical	30"	18"	17 ³ / ₄ "			\$ 5,750	





	MODEL NUMBER	PRODUCT	WIDTH	DEPTH	HEIGHT	WEIGHT	VOLUME	LIST PRICE	DESCRIPTION
	SM3-02-W	SINGLE BENCH - 1 OPEN SIDE Veneer Surface with No Electrical	30"	18"	16 ³ / ₄ "			\$ 4,263	<p>BENCH SEATING: Constructed from 1" high density particleboard core with grade 'A' face veneers. Each bench position consists of an open cubby 9³/₄" deep x 28 wide x 10¹/₄" high.</p> <p>ELECTRICAL: PW-100-MT electrical unit consisting of (1) outlet and (2) USB ports located on the side.</p> <p>FURNITURE LEGS: Legs are 4" high, polished chrome designer series with a rubber feet.</p> <p>UPHOLSTERED SEATS: SM-3 Benches is available in a large selection of Contract grade fabrics; Cornerblock, Foundation, Journey Fabrics or Turner Vinyl is also available as an upcharge.</p>
	SM3-02-W-EL	Veneer Surface with (2) Electrical	30"	18"	16 ³ / ₄ "			\$ 5,206	
	SM3-02-U	Upholstered Seat with No Electrical	30"	18"	17 ³ / ₄ "			\$ 4,788	
	SM3-02-U-EL	Upholstered Seat with (2) Electrical	30"	18"	17 ³ / ₄ "			\$ 5,731	





	MODEL NUMBER	PRODUCT	WIDTH	DEPTH	HEIGHT	WEIGHT	VOLUME	LIST PRICE	DESCRIPTION
	SM3-03-W	SINGLE BENCH - 2 OPEN ENDS Veneer Surface with No Electrical	30"	18"	16 ³ / ₄ "			\$ 4,313	<p>BENCH SEATING: Constructed from 1" high density particleboard core with grade 'A' face veneers. Each bench position consists of two open cubbies 9³/₄" deep x 16 wide x 10¹/₄" high.</p> <p>ELECTRICAL: PW-100-MT electrical unit consisting of (1) outlet and (2) USB ports located on the side.</p> <p>FURNITURE LEGS: Legs are 4" high, polished chrome designer series with a rubber feet.</p>
	SM3-03-W-EL	Veneer Surface with (1) Electrical	30"	18"	16 ³ / ₄ "			\$ 5,263	<p>UPHOLSTERED SEATS: SM-3 Benches is available in a large selection of Contract grade fabrics; Cornerblock, Foundation, Journey Fabrics or Turner Vinyl is also available as an upcharge.</p>
	SM3-03-U	Upholstered Seat with No Electrical	30"	18"	17 ³ / ₄ "			\$ 4,838	
	SM3-03-U-EL	Upholstered Seat with (1) Electrical	30"	18"	17 ³ / ₄ "			\$ 5,788	





MODEL NUMBER	PRODUCT	WIDTH	DEPTH	HEIGHT	WEIGHT	VOLUME	LIST PRICE	DESCRIPTION
 SM3-04-W	TABLE							
	Veneer Surface with No Electrical	30"	30"	10"			\$ 4,294	<p>TABLE: Constructed from 1" high density particleboard core with grade 'A' face veneers.</p> <p>ELECTRICAL: PW-100-MT electrical unit consisting of (1) outlet and (2) USB ports located on the top corners</p> <p>FURNITURE LEGS: Legs are 4" high, polished chrome designer series with a rubber feet.</p>
 SM3-04-W-EL	Veneer Surface with (2) Electrical	30"	30"	10"			\$ 5,244	





SM3 Bench and Table Layout Configurations











	MODEL NUMBER	PRODUCT	WIDTH	DEPTH	HEIGHT	WEIGHT	VOLUME	LIST PRICE	DESCRIPTION
	SM3-10-W	DOUBLE BENCH - 1 OPEN SIDE WITH DIVIDER Veneer Surface with No Electrical	84"	18"	16 ³ / ₄ "			\$ 6,794	<p>BENCH SEATING: Constructed from 1" high density particleboard core with grade 'A' face veneers. Each bench position consists of two open cubbies 9³/₄" deep x 40¹/₂" wide x 10¹/₄" high.</p> <p>ELECTRICAL: PW-100-MT electrical unit consisting of (1) outlet and (2) USB ports located on the side.</p> <p>FURNITURE LEGS: Legs are 4" high, polished chrome designer series with a rubber feet.</p> <p>UPHOLSTERED SEATS: SM-3 Benches is available in a large selection of Contract grade fabrics; Cornerblock, Foundation, Journey Fabrics or Turner Vinyl is also available as an upcharge. (2) individual seat pads</p>
	SM3-10-W-EL	Veneer Surface with (2) Electrical	84"	18"	16 ³ / ₄ "			\$ 7,744	
	SM3-10-U	Upholstered Seat with No Electrical	84"	18"	17 ³ / ₄ "			\$ 7,319	
	SM3-10-U-EL	Upholstered Seat with (2) Electrical	84"	18"	17 ³ / ₄ "			\$ 8,263	





	MODEL NUMBER	PRODUCT	WIDTH	DEPTH	HEIGHT	WEIGHT	VOLUME	LIST PRICE	DESCRIPTION
	SM3-11-W	DOUBLE BENCH - OFFSET OPEN SIDE, OPPOSITE SIDES Veneer Surface with No Electrical	84"	18"	16 ³ / ₄ "			\$ 6,344	<p>BENCH SEATING: Constructed from 1" high density particleboard core with grade 'A' face veneers. Each bench position consists of two opposing open cubbies 9³/₄" deep x 40¹/₂" wide x 10¹/₄" high.</p> <p>ELECTRICAL: PW-100-MT electrical unit consisting of (1) outlet and (2) USB ports located on the side.</p> <p>FURNITURE LEGS: Legs are 4" high, polished chrome designer series with a rubber feet.</p> <p>UPHOLSTERED SEATS: SM-3 Benches is available in a large selection of Contract grade fabrics; Cornerblock, Foundation, Journey Fabrics or Turner Vinyl is also available as an upcharge. (2) individual seat pads</p>
	SM3-11-W-EL	Veneer Surface with (4) Electrical	84"	18"	16 ³ / ₄ "			\$ 7,294	
	SM3-11-U	Upholstered Seat with No Electrical	84"	18"	17 ³ / ₄ "			\$ 6,869	
	SM3-11-U-EL	Upholstered Seat with (4) Electrical	84"	18"	17 ³ / ₄ "			\$ 7,813	





	MODEL NUMBER	PRODUCT	WIDTH	DEPTH	HEIGHT	WEIGHT	VOLUME	LIST PRICE	DESCRIPTION
	SM3-12-W	DOUBLE BENCH - 1 OPEN SIDE, 1 OPEN END Veneer Surface with No Electrical	84"	18"	16 ³ / ₄ "			\$ 6,719	<p>BENCH SEATING: Constructed from 1" high density particleboard core with grade 'A' face veneers. Each bench position consists of an open left cubby 9³/₄" deep x 40¹/₂" wide x 10¹/₄" high and an open right end cubby 9³/₄" deep x 16" wide x 10¹/₄" high.</p> <p>ELECTRICAL: PW-100-MT electrical unit consisting of (1) outlet and (2) USB ports located on the side.</p> <p>FURNITURE LEGS: Legs are 4" high, polished chrome designer series with a rubber feet.</p> <p>UPHOLSTERED SEATS: SM-3 Benches is available in a large selection of Contract grade fabrics; Cornerblock, Foundation, Journey Fabrics or Turner Vinyl is also available as an upcharge. (2) individual seat pads</p>
	SM3-12-W-EL	Wood Veneer top (2) Electrical	84"	18"	16 ³ / ₄ "			\$ 7,669	
	SM3-12-U	Upholstered Seat with No Electrical	84"	18"	17 ³ / ₄ "			\$ 7,244	
	SM3-12-U-EL	Upholstered Seat with (2) Electrical	84"	18"	17 ³ / ₄ "			\$ 8,188	



	MODEL NUMBER	PRODUCT	WIDTH	DEPTH	HEIGHT	WEIGHT	VOLUME	LIST PRICE	DESCRIPTION
	SM3-13-W	DOUBLE BENCH - 1 OPEN SIDE, 2 OPEN ENDS Veneer Surface with No Electrical	84"	18"	16 ³ / ₄ "			\$ 7,119	<p>BENCH SEATING: Constructed from 1" high density particleboard core with grade 'A' face veneers. Each bench position consists of an open cubby 9³/₄" deep x 48" wide x 10¹/₄" high and two open end cubbies 9³/₄" deep x 16" wide x 10¹/₄" high.</p> <p>ELECTRICAL: PW-100-MT electrical unit consisting of (1) outlet and (2) USB ports located on the side.</p> <p>FURNITURE LEGS: Legs are 4" high, polished chrome designer series with a rubber feet.</p> <p>UPHOLSTERED SEATS: SM-3 Benches is available in a large selection of Contract grade fabrics; Cornerblock, Foundation, Journey Fabrics or Turner Vinyl is also available as an upcharge. (2) individual seat pads</p>
	SM3-13-W-EL	Veneer Surface with (2) Electrical	84"	18"	16 ³ / ₄ "			\$ 8,069	
	SM3-13-U	Upholstered Seat with No Electrical	84"	18"	17 ³ / ₄ "			\$ 7,644	
	SM3-13-U-EL	Upholstered Seat with (2) Electrical	84"	18"	17 ³ / ₄ "			\$ 8,588	

	MODEL NUMBER	PRODUCT	WIDTH	DEPTH	HEIGHT	WEIGHT	VOLUME	LIST PRICE	DESCRIPTION
	SM3-20-W	QUAD BENCH - 2 OPEN SIDES WITH DIVIDERS Veneer Surface with No Electrical	84"	30"	16 ³ / ₄ "			\$ 8,844	<p>BENCH SEATING: Constructed from 1" high density particleboard core with grade 'A' face veneers. Each bench position consists of four open cubbies 9³/₄" deep x 40¹/₂" wide x 10¹/₄" high.</p> <p>ELECTRICAL: PW-100-MT electrical unit consisting of (1) outlet and (2) USB ports located on the side.</p> <p>FURNITURE LEGS: Legs are 4" high, polished chrome designer series with a rubber feet.</p> <p>UPHOLSTERED SEATS: SM-3 Benches is available in a large selection of Contract grade fabrics; Cornerblock, Foundation, Journey Fabrics or Turner Vinyl is also available as an upcharge. (4) individual seat pads</p>
	SM3-20-W-EL	Veneer Surface with (2) Electrical	84"	30"	16 ³ / ₄ "			\$ 9,794	
	SM3-20-U	Wood Veneer top No Electrical	84"	30"	17 ³ / ₄ "			\$ 10,444	
	SM3-20-U-EL	Wood Veneer top (2) Electrical	84"	30"	17 ³ / ₄ "			\$ 11,394	

MODEL NUMBER	PRODUCT	WIDTH	DEPTH	HEIGHT	WEIGHT	VOLUME	LIST PRICE	DESCRIPTION
 SM3-21-W	QUAD BENCH - OFFSET OPEN SIDE, OPPOSITE SIDES Veneer Surface with No Electrical	84"	30"	16 ³ / ₄ "			\$ 8,400	<p>BENCH SEATING: Constructed from 1" high density particleboard core with grade 'A' face veneers. Each bench position consists of two opposing open cubbies 9³/₄" deep x 40¹/₂" wide x 10¹/₄" high.</p> <p>ELECTRICAL PW-100-MT electrical unit consisting of (1) outlet and (2) USB ports located on the side.</p> <p>FURNITURE LEGS: Legs are 4" high, polished chrome designer series with a rubber feet.</p>
 SM3-21-W-EL	Veneer Surface with (4) Electrical	84"	30"	16 ³ / ₄ "			\$ 9,350	<p>UPHOLSTERED SEATS: SM-3 Benches is available in a large selection of Contract grade fabrics; Cornerblock, Foundation, Journey Fabrics or Turner Vinyl is also available as an upcharge. (4) individual seat pads</p>
 SM3-21-U	Upholstered Seat with No Electrical	84"	30"	17 ³ / ₄ "			\$ 8,625	
 SM3-21-U-EL	Upholstered Seat with (4) Electrical	84"	30"	17 ³ / ₄ "			\$ 10,950	

MODEL NUMBER	PRODUCT	WIDTH	DEPTH	HEIGHT	WEIGHT	VOLUME	LIST PRICE	DESCRIPTION
 SM3-22-W	QUAD BENCH - 2 OFFSET OPEN SIDES, 2 OFFSET OPEN ENDS Veneer Surface with No Electrical	84"	30"	16 ³ / ₄ "			\$ 8,419	<p>BENCH SEATING: Constructed from 1" high density particleboard core with grade 'A' face veneers. Each bench position consists two opposing open cubbies 9³/₄" deep x 40¹/₂" wide x 10¹/₄" high and two opposing open right end cubbies 9³/₄" deep x 16" wide x 10¹/₄" high.</p>
 SM3-22-W-EL	Veneer Surface with (4) Electrical	84"	30"	16 ³ / ₄ "			\$ 9,369	<p>ELECTRICAL: PW-100-MT electrical unit consisting of (1) outlet and (2) USB ports located on the side.</p> <p>FURNITURE LEGS: Legs are 4" high, polished chrome designer series with a rubber feet.</p>
 SM3-22-U	Upholstered Seat with No Electrical	84"	30"	17 ³ / ₄ "			\$ 10,019	<p>UPHOLSTERED SEATS: SM-3 Benches is available in a large selection of Contract grade fabrics; Cornerblock, Foundation, Journey Fabrics or Turner Vinyl is also available as an upcharge. (4) individual seat pads</p>
 SM3-22-U-EL	Upholstered Seat with (4) Electrical	84"	30"	17 ³ / ₄ "			\$ 10,969	

	MODEL NUMBER	PRODUCT	WIDTH	DEPTH	HEIGHT	WEIGHT	VOLUME	LIST PRICE	DESCRIPTION
	SM3-23-W	QUAD BENCH - 2 OPEN SIDES, 2 OPEN ENDS Veneer Surface with No Electrical	84"	30"	16 ³ / ₄ "			\$ 8,794	<p>BENCH SEATING: Constructed from 1" high density particleboard core with grade 'A' face veneers. Each bench position consists of two open cubbies 9³/₄" deep x 48" wide x 10¹/₄" high and two open end cubbies 9³/₄" deep x 16" wide x 10¹/₄" high.</p> <p>ELECTRICAL: PW-100-MT electrical unit consisting of (1) outlet and (2) USB ports located on the side.</p> <p>FURNITURE LEGS: Legs are 4" high, polished chrome designer series with a rubber feet.</p> <p>UPHOLSTERED SEATS: SM-3 Benches is available in a large selection of Contract grade fabrics; Cornerblock, Foundation, Journey Fabrics or Turner Vinyl is also available as an upcharge. (4) individual seat pads</p>
	SM3-23-W-EL	Veneer Surface with (4) Electrical	84"	30"	16 ³ / ₄ "			\$ 9,744	
	SM3-23-U	Upholstered Seat with No Electrical	84"	30"	17 ³ / ₄ "			\$ 10,394	
	SM3-23-U-EL	Upholstered Seat with (4) Electrical	84"	30"	17 ³ / ₄ "			\$ 11,344	

	MODEL NUMBER	PRODUCT	WIDTH	DEPTH	HEIGHT	WEIGHT	VOLUME	LIST PRICE	DESCRIPTION
		FIXED HEIGHT							
	SM4-1-3030-W	Wood Veneer Top	30"	30"	29"			\$ 2,038	<p>TOP: Constructed of 1" thick high density particleboard core with plastic laminate or wood veneer. Profile edge consists of an internal solid hardwood with a 3/4" radius from underside and a soft radius profile top.</p> <p>FIXED METAL BASE: Base consists of a 3 3/4" diameter tubular 16 gauge steel column and the steel base is 3/16" thick with a tapered profile.</p> <p>ADJUSTABLE METAL BASE: Base consists of a 3 3/4" diameter tubular 16 gauge steel pneumatic lift column and the steel base is 3/16" thick with a soft radius profile.</p>
	SM4-1-3030-L	Laminate Top	30"	30"	29"			\$ 1,950	
	SM4-1-3636-W	Wood Veneer Top	36"	36"	29"			\$ 2,188	
	SM4-1-3636-L	Laminate Top	36"	36"	29"			\$ 2,106	
	SM4-1-4242-W	Wood Veneer Top	42"	42"	29"			\$ 2,338	
	SM4-1-4242-L	Laminate Top	42"	42"	29"			\$ 2,263	
			ADJUSTABLE HEIGHT						
SM4-2-3030-W		Wood Veneer Top	30"	30"	27 1/2" to 43 3/4"			\$ 4,956	
SM4-2-3030-L		Laminate Top	30"	30"	27 1/2" to 43 3/4"			\$ 4,881	
SM4-2-3636-W		Wood Veneer Top	36"	36"	27 1/2" to 43 3/4"			\$ 5,325	
SM4-2-3636-L		Laminate Top	36"	36"	27 1/2" to 43 3/4"			\$ 5,244	
SM4-2-4242-W		Wood Veneer Top	42"	42"	27 1/2" to 43 3/4"			\$ 5,694	
SM4-2-4242-L		Laminate Top	42"	42"	27 1/2" to 43 3/4"			\$ 5,613	

SM4 Adjustable Table Height (underside image) and Fixed Height Table





MODEL NUMBER	PRODUCT	WIDTH	DEPTH	HEIGHT	LIST PRICE
Tapered Standard Top - 46" Table					
SM5-TS-4660-AC	Acrylic Edge	54"	66 1/2"	73 3/8"	Table Size: 46" D x 60" W x 29"H \$ 16,756
SM5-TS-4660-SQ	Square Edge	54"	66 1/2"	73 3/8"	Table Size: 46" D x 60" W x 29"H \$ 17,069
SM5-TS-4666-AC	Acrylic Edge	54"	72 1/2"	73 3/8"	Table Size: 46" D x 66" W x 29"H \$ 16,800
SM5-TS-4666-SQ	Square Edge	54"	72 1/2"	73 3/8"	Table Size: 46" D x 66" W x 29"H \$ 17,138
SM5-TS-4672-AC	Acrylic Edge	54"	78 1/2"	73 3/8"	Table Size: 46" D x 72" W x 29"H \$ 16,825
SM5-TS-4672-SQ	Square Edge	54"	78 1/2"	73 3/8"	Table Size: 46" D x 72" W x 29"H \$ 17,188
SM5-TS-4678-AC	Acrylic Edge	54"	84 1/2"	73 3/8"	Table Size: 46" D x 78" W x 29"H \$ 16,869
SM5-TS-4678-SQ	Square Edge	54"	84 1/2"	73 3/8"	Table Size: 46" D x 78" W x 29"H \$ 17,263
Tapered Standard Top - 48" Table					
SM5-TS-4860-AC	Acrylic Edge	54"	66 1/2"	73 3/8"	Table Size: 48" D x 60" W x 29"H \$ 16,944
SM5-TS-4860-SQ	Square Edge	54"	66 1/2"	73 3/8"	Table Size: 48" D x 60" W x 29"H \$ 17,256
SM5-TS-4866-AC	Acrylic Edge	54"	72 1/2"	73 3/8"	Table Size: 48" D x 66" W x 29"H \$ 16,988
SM5-TS-4866-SQ	Square Edge	54"	72 1/2"	73 3/8"	Table Size: 48" D x 66" W x 29"H \$ 17,325
SM5-TS-4872-AC	Acrylic Edge	54"	78 1/2"	73 3/8"	Table Size: 48" D x 72" W x 29"H \$ 17,013
SM5-TS-4872-SQ	Square Edge	54"	78 1/2"	73 3/8"	Table Size: 48" D x 72" W x 29"H \$ 17,375
SM5-TS-4878-AC	Acrylic Edge	54"	84 1/2"	73 3/8"	Table Size: 48" D x 78" W x 29"H \$ 17,056
SM5-TS-4878-SQ	Square Edge	54"	84 1/2"	73 3/8"	Table Size: 48" D x 78" W x 29"H \$ 17,450

SM5 is a versatile, comprehensive furniture solution that offers a range of features allowing for digital sharing for today's interactive environments.

- Tables are available in a series of shapes and sizes that accommodate many group sizes.
- Wire management is completely integrated allowing for a clean uncluttered installation.
- SM5 can be placed anywhere in a room with options to accommodate double sided applications.
- Equipment and connections are ventilated and can be easily installed and accessed at any time.
- Optional connections for power, data, and video are integrated directly into SM5.

Metal Table Base and Media Wall Footing: 16 Gauge Metal with Palmieri metal paint options in Gloss White, Satin Black or Polished Chrome.

Media Wall for Flat Screen/TV is 54" Width x 6 1/2" Depth x 73 3/8" Height. Recommend Flat Screen/TV size is 46" to 49".

NOTE: Electrical, Flat Screen/TV, and TV Mounting Hardware are NOT included.

SM5 has two edge profiles available:

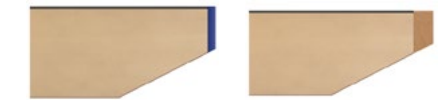

Model "AC"
3mm Acrylic
Edge

Model "SQ"
1/8" Square Edge

* Seating accommodation is based on an 18" Chair Width. Accommodation is approximate, and can vary depending on user's personal space requirements.

SM5-TS-4660
SM5-TS-4860



SM5-TS-4666
SM5-TS-4866



SM5-TS-4672
SM5-TS-4872



SM5-TS-4678
SM5-TS-4878



MODEL NUMBER	PRODUCT	WIDTH	DEPTH	HEIGHT
--------------	---------	-------	-------	--------

LIST PRICE

DESCRIPTION

Tapered Bullet Top - 46" Table

SM5-TB-4660-AC	Acrylic Edge	54"	66 1/2"	73 3/8"
SM5-TB-4660-SQ	Square Edge	54"	66 1/2"	73 3/8"
SM5-TB-4666-AC	Acrylic Edge	54"	72 1/2"	73 3/8"
SM5-TB-4666-SQ	Square Edge	54"	72 1/2"	73 3/8"
SM5-TB-4672-AC	Acrylic Edge	54"	78 1/2"	73 3/8"
SM5-TB-4672-SQ	Square Edge	54"	78 1/2"	73 3/8"
SM5-TB-4678-AC	Acrylic Edge	54"	84 1/2"	73 3/8"
SM5-TB-4678-SQ	Square Edge	54"	84 1/2"	73 3/8"

Table Size: 46" D x 60" W x 29"H	\$ 16,756
Table Size: 46" D x 60" W x 29"H	\$ 17,069
Table Size: 46" D x 66" W x 29"H	\$ 16,800
Table Size: 46" D x 66" W x 29"H	\$ 17,138
Table Size: 46" D x 72" W x 29"H	\$ 16,825
Table Size: 46" D x 72" W x 29"H	\$ 17,188
Table Size: 46" D x 78" W x 29"H	\$ 16,869
Table Size: 46" D x 78" W x 29"H	\$ 17,263

SM5 is a versatile, comprehensive furniture solution that offers a range of features allowing for digital sharing for today's interactive environments.

- Tables are available in a series of shapes and sizes that accommodate many group sizes.
- Wire management is completely integrated allowing for a clean uncluttered installation.
- SM5 can be placed anywhere in a room with options to accommodate double sided applications.
- Equipment and connections are ventilated and can be easily installed and accessed at any time.
- Optional connections for power, data, and video are integrated directly into SM5.

Metal Table Base and Media Wall Footing: 16 Gauge Metal with Palmieri metal paint options in Gloss White, Satin Black or Polished Chrome.

Media Wall for Flat Screen/TV is 54" Width x 6 1/2" Depth x 73 3/8" Height. Recommend Flat Screen/TV size is 46" to 49".

NOTE: Electrical, Flat Screen/TV, and TV Mounting Hardware are NOT included.

SM5 has two edge profiles available:



Model "AC"
3mm Acrylic
Edge

Model "SQ"
1/8" Square Edge

Tapered Bullet Top - 48" Table

SM5-TB-4860-AC	Acrylic Edge	54"	66 1/2"	73 3/8"
SM5-TB-4860-SQ	Square Edge	54"	66 1/2"	73 3/8"
SM5-TB-4866-AC	Acrylic Edge	54"	72 1/2"	73 3/8"
SM5-TB-4866-SQ	Square Edge	54"	72 1/2"	73 3/8"
SM5-TB-4872-AC	Acrylic Edge	54"	78 1/2"	73 3/8"
SM5-TB-4872-SQ	Square Edge	54"	78 1/2"	73 3/8"
SM5-TB-4878-AC	Acrylic Edge	54"	84 1/2"	73 3/8"
SM5-TB-4878-SQ	Square Edge	54"	84 1/2"	73 3/8"

Table Size: 48" D x 60" W x 29"H	\$ 16,944
Table Size: 48" D x 60" W x 29"H	\$ 17,256
Table Size: 48" D x 66" W x 29"H	\$ 16,988
Table Size: 48" D x 66" W x 29"H	\$ 17,325
Table Size: 48" D x 72" W x 29"H	\$ 17,013
Table Size: 48" D x 72" W x 29"H	\$ 17,375
Table Size: 48" D x 78" W x 29"H	\$ 17,056
Table Size: 48" D x 78" W x 29"H	\$ 17,450

* Seating accommodation is based on an 18" Chair Width. Accommodation is approximate, and can vary depending on user's personal space requirements.

SM5-TB-4660
SM5-TB-4860



SM5-TB-4666
SM5-TB-4866



SM5-TB-4672
SM5-TB-4872



SM5-TB-4678
SM5-TB-4878



MODEL NUMBER

PRODUCT

WIDTH DEPTH HEIGHT

LIST PRICE

DESCRIPTION

Tapered Round Top - 46" Table

SM5-TR-4660-AC	Acrylic Edge	54"	66 1/2"	73 3/8"	Table Size: 46" D x 60" W x 29"H	\$ 17,038
SM5-TR-4660-SQ	Square Edge	54"	66 1/2"	73 3/8"	Table Size: 46" D x 60" W x 29"H	\$ 17,338
SM5-TR-4666-AC	Acrylic Edge	54"	72 1/2"	73 3/8"	Table Size: 46" D x 66" W x 29"H	\$ 17,113
SM5-TR-4666-SQ	Square Edge	54"	72 1/2"	73 3/8"	Table Size: 46" D x 66" W x 29"H	\$ 17,438
SM5-TR-4672-AC	Acrylic Edge	54"	78 1/2"	73 3/8"	Table Size: 46" D x 72" W x 29"H	\$ 17,163
SM5-TR-4672-SQ	Square Edge	54"	78 1/2"	73 3/8"	Table Size: 46" D x 72" W x 29"H	\$ 17,513
SM5-TR-4678-AC	Acrylic Edge	54"	84 1/2"	73 3/8"	Table Size: 46" D x 78" W x 29"H	\$ 17,244
SM5-TR-4678-SQ	Square Edge	54"	84 1/2"	73 3/8"	Table Size: 46" D x 78" W x 29"H	\$ 17,613

Tapered Round Top - 48" Table

SM5-TR-4860-AC	Acrylic Edge	54"	66 1/2"	73 3/8"	Table Size: 48" D x 60" W x 29"H	\$ 17,225
SM5-TR-4860-SQ	Square Edge	54"	66 1/2"	73 3/8"	Table Size: 48" D x 60" W x 29"H	\$ 17,525
SM5-TR-4866-AC	Acrylic Edge	54"	72 1/2"	73 3/8"	Table Size: 48" D x 66" W x 29"H	\$ 17,300
SM5-TR-4866-SQ	Square Edge	54"	72 1/2"	73 3/8"	Table Size: 48" D x 66" W x 29"H	\$ 17,625
SM5-TR-4872-AC	Acrylic Edge	54"	78 1/2"	73 3/8"	Table Size: 48" D x 72" W x 29"H	\$ 17,350
SM5-TR-4872-SQ	Square Edge	54"	78 1/2"	73 3/8"	Table Size: 48" D x 72" W x 29"H	\$ 17,700
SM5-TR-4878-AC	Acrylic Edge	54"	84 1/2"	73 3/8"	Table Size: 48" D x 78" W x 29"H	\$ 17,431
SM5-TR-4878-SQ	Square Edge	54"	84 1/2"	73 3/8"	Table Size: 48" D x 78" W x 29"H	\$ 17,800

SM5 is a versatile, comprehensive furniture solution that offers a range of features allowing for digital sharing for today's interactive environments.

- Tables are available in a series of shapes and sizes that accommodate many group sizes.
- Wire management is completely integrated allowing for a clean uncluttered installation.
- SM5 can be placed anywhere in a room with options to accommodate double sided applications.
- Equipment and connections are ventilated and can be easily installed and accessed at any time.
- Optional connections for power, data, and video are integrated directly into SM5.

Metal Table Base and Media Wall Footing: 16 Gauge Metal with Palmieri metal paint options in Gloss White, Satin Black or Polished Chrome.

Media Wall for Flat Screen/TV is 54" Width x 6 1/2" Depth x 73 3/8" Height. Recommend Flat Screen/TV size is 46" to 49".

NOTE: Electrical, Flat Screen/TV, and TV Mounting Hardware are NOT included.

SM5 has two edge profiles available:



Model "AC"
3mm Acrylic
Edge

Model "SQ"
1/8" Square Edge

* Seating accommodation is based on an 18" Chair Width. Accommodation is approximate, and can vary depending on user's personal space requirements.

SM5-TR-4660
SM5-TR-4860



SM5-TR-4666
SM5-TR-4866



SM5-TR-4672
SM5-TR-4872



SM5-TR-4678
SM5-TR-4878





MODEL NUMBER	PRODUCT	WIDTH	DEPTH	HEIGHT	LIST PRICE
SHORT BACK 31" HIGH					
Tapered Standard Top - 46" Table					
SM5-2-TS-4660-AC	Acrylic Edge	54"	61 1/4"	31"	Table Size: 46" D x 60" W x 29"H \$ 9,331
SM5-2-TS-4660-SQ	Square Edge	54"	61 1/4"	31"	Table Size: 46" D x 60" W x 29"H \$ 9,500
SM5-2-TS-4666-AC	Acrylic Edge	54"	67 1/4"	31"	Table Size: 46" D x 66" W x 29"H \$ 9,356
SM5-2-TS-4666-SQ	Square Edge	54"	67 1/4"	31"	Table Size: 46" D x 66" W x 29"H \$ 9,538
SM5-2-TS-4672-AC	Acrylic Edge	54"	73 1/4"	31"	Table Size: 46" D x 72" W x 29"H \$ 9,369
SM5-2-TS-4672-SQ	Square Edge	54"	73 1/4"	31"	Table Size: 46" D x 72" W x 29"H \$ 9,563
SM5-2-TS-4678-AC	Acrylic Edge	54"	79 1/4"	31"	Table Size: 46" D x 78" W x 29"H \$ 9,388
SM5-2-TS-4678-SQ	Square Edge	54"	79 1/4"	31"	Table Size: 46" D x 78" W x 29"H \$ 9,613
Tapered Standard Top - 48" Table					
SM5-2-TS-4860-AC	Acrylic Edge	54"	61 1/4"	31"	Table Size: 48" D x 60" W x 29"H \$ 9,431
SM5-2-TS-4860-SQ	Square Edge	54"	61 1/4"	31"	Table Size: 48" D x 60" W x 29"H \$ 9,606
SM5-2-TS-4866-AC	Acrylic Edge	54"	67 1/4"	31"	Table Size: 48" D x 66" W x 29"H \$ 9,456
SM5-2-TS-4866-SQ	Square Edge	54"	67 1/4"	31"	Table Size: 48" D x 66" W x 29"H \$ 9,644
SM5-2-TS-4872-AC	Acrylic Edge	54"	73 1/4"	31"	Table Size: 48" D x 72" W x 29"H \$ 9,438
SM5-2-TS-4872-SQ	Square Edge	54"	73 1/4"	31"	Table Size: 48" D x 72" W x 29"H \$ 9,675
SM5-2-TS-4878-AC	Acrylic Edge	54"	79 1/4"	31"	Table Size: 48" D x 78" W x 29"H \$ 9,500
SM5-2-TS-4878-SQ	Square Edge	54"	79 1/4"	31"	Table Size: 48" D x 78" W x 29"H \$ 9,713

SM5-2 is a versatile, comprehensive furniture solution that offers a range of features allowing for digital sharing for today's interactive environments.

- Work table is available in the Tapered Standard Top shape and various sizes. Table base consists of 16" gauge metal with Palmieri standard metal paint options.

SM5-2 has two edge profiles available:



Model "AC"
3mm Acrylic
Edge

Model "SQ"
1/8" Square
Edge



MODEL NUMBER	PRODUCT	WIDTH	DEPTH	HEIGHT	LIST PRICE
SHORT BACK 31" HIGH					
Tapered Bullet Top - 46" Table					
SM5-2-TB-4660-AC	Acrylic Edge	54"	61 1/4"	31"	Table Size: 46" D x 60" W x 29"H \$ 9,331
SM5-2-TB-4660-SQ	Square Edge	54"	61 1/4"	31"	Table Size: 46" D x 60" W x 29"H \$ 9,500
SM5-2-TB-4666-AC	Acrylic Edge	54"	67 1/4"	31"	Table Size: 46" D x 66" W x 29"H \$ 9,356
SM5-2-TB-4666-SQ	Square Edge	54"	67 1/4"	31"	Table Size: 46" D x 66" W x 29"H \$ 9,538
SM5-2-TB-4672-AC	Acrylic Edge	54"	73 1/4"	31"	Table Size: 46" D x 72" W x 29"H \$ 9,369
SM5-2-TB-4672-SQ	Square Edge	54"	73 1/4"	31"	Table Size: 46" D x 72" W x 29"H \$ 9,563
SM5-2-TB-4678-AC	Acrylic Edge	54"	79 1/4"	31"	Table Size: 46" D x 78" W x 29"H \$ 9,388
SM5-2-TB-4678-SQ	Square Edge	54"	79 1/4"	31"	Table Size: 46" D x 78" W x 29"H \$ 9,613
Tapered Bullet Top - 48" Table					
SM5-2-TB-4860-AC	Acrylic Edge	54"	61 1/4"	31"	Table Size: 48" D x 60" W x 29"H \$ 9,431
SM5-2-TB-4860-SQ	Square Edge	54"	61 1/4"	31"	Table Size: 48" D x 60" W x 29"H \$ 9,606
SM5-2-TB-4866-AC	Acrylic Edge	54"	67 1/4"	31"	Table Size: 48" D x 66" W x 29"H \$ 9,456
SM5-2-TB-4866-SQ	Square Edge	54"	67 1/4"	31"	Table Size: 48" D x 66" W x 29"H \$ 9,644
SM5-2-TB-4872-AC	Acrylic Edge	54"	73 1/4"	31"	Table Size: 48" D x 72" W x 29"H \$ 9,438
SM5-2-TB-4872-SQ	Square Edge	54"	73 1/4"	31"	Table Size: 48" D x 72" W x 29"H \$ 9,675
SM5-2-TB-4878-AC	Acrylic Edge	54"	79 1/4"	31"	Table Size: 48" D x 78" W x 29"H \$ 9,500
SM5-2-TB-4878-SQ	Square Edge	54"	79 1/4"	31"	Table Size: 48" D x 78" W x 29"H \$ 9,713

SM5-2 is a versatile, comprehensive furniture solution that offers a range of features allowing for digital sharing for today's interactive environments.

- Work table is available in the Tapered Standard Top shape and various sizes. Table base consists of 16" gauge metal with Palmieri standard metal paint options.

SM5-2 has two edge profiles available:

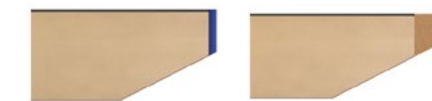

Model "AC"
3mm Acrylic
Edge

Model "SQ"
1/8" Square Edge



MODEL NUMBER	PRODUCT	WIDTH	DEPTH	HEIGHT	LIST PRICE	DESCRIPTION
SHORT BACK 31" HIGH						
Tapered Round Top - 46" Table						
SM5-2-TR-4660-AC	Acrylic Edge	54"	61 1/4"	31"	Table Size: 46" D x 60" W x 29"H	\$ 9,469
SM5-2-TR-4660-SQ	Square Edge	54"	61 1/4"	31"	Table Size: 46" D x 60" W x 29"H	\$ 9,644
SM5-2-TR-4666-AC	Acrylic Edge	54"	67 1/4"	31"	Table Size: 46" D x 66" W x 29"H	\$ 9,475
SM5-2-TR-4666-SQ	Square Edge	54"	67 1/4"	31"	Table Size: 46" D x 66" W x 29"H	\$ 9,681
SM5-2-TR-4672-AC	Acrylic Edge	54"	73 1/4"	31"	Table Size: 46" D x 72" W x 29"H	\$ 9,513
SM5-2-TR-4672-SQ	Square Edge	54"	73 1/4"	31"	Table Size: 46" D x 72" W x 29"H	\$ 9,706
SM5-2-TR-4678-AC	Acrylic Edge	54"	79 1/4"	31"	Table Size: 46" D x 78" W x 29"H	\$ 9,531
SM5-2-TR-4678-SQ	Square Edge	54"	79 1/4"	31"	Table Size: 46" D x 78" W x 29"H	\$ 9,756
Tapered Round Top - 48" Table						
SM5-2-TR-4860-AC	Acrylic Edge	54"	61 1/4"	31"	Table Size: 48" D x 60" W x 29"H	\$ 9,575
SM5-2-TR-4860-SQ	Square Edge	54"	61 1/4"	31"	Table Size: 48" D x 60" W x 29"H	\$ 9,750
SM5-2-TR-4866-AC	Acrylic Edge	54"	67 1/4"	31"	Table Size: 48" D x 66" W x 29"H	\$ 9,600
SM5-2-TR-4866-SQ	Square Edge	54"	67 1/4"	31"	Table Size: 48" D x 66" W x 29"H	\$ 9,788
SM5-2-TR-4872-AC	Acrylic Edge	54"	73 1/4"	31"	Table Size: 48" D x 72" W x 29"H	\$ 9,581
SM5-2-TR-4872-SQ	Square Edge	54"	73 1/4"	31"	Table Size: 48" D x 72" W x 29"H	\$ 9,819
SM5-2-TR-4878-AC	Acrylic Edge	54"	79 1/4"	31"	Table Size: 48" D x 78" W x 29"H	\$ 9,644
SM5-2-TR-4878-SQ	Square Edge	54"	79 1/4"	31"	Table Size: 48" D x 78" W x 29"H	\$ 9,856

SM5-2 is a versatile, comprehensive furniture solution that offers a range of features allowing for digital sharing for today's interactive environments.





- Work table is available in the Tapered Standard Top shape and various sizes. Table base consists of 16" gauge metal with Palmieri standard metal paint options.

SM5-2 has two edge profiles available:



Model "AC"
3mm Acrylic
Edge

Model "SQ"
1/8" Square Edge

	MODEL NUMBER	PRODUCT	WIDTH	DEPTH	HEIGHT	WEIGHT	VOLUME	LIST PRICE	DESCRIPTION
	P-PS-B	Power Sphere: 4 Outlet Black	3"		1 1/2"			\$ 344	
	P-PS-T	Translucent						\$ 344	
	P-PDS-B	Power Sphere: 2 Outlet, 2 Data	3"		1 1/2"			\$ 269	
	P-PDS-T	Black Translucent						\$ 269	
	PW-200F	Flip Up Power Station: Cordset	14"		5 3/8"			\$ 5,044	PW-200F: Recessed power station unit with clear anodized aluminum finish. An easy lift hinge allows cover to be flush with work surface when not in use. Unit complete with 2 power receptacles 15 AMP/125 Volt, 1 USB2 Port simplex charger, 1 four-user VGA kit and 1 open data port. Other power and data configurations are available. A 120" power cord is provided.
	PW-100J	Junior Flip Up Power Station: Cordset	5 3/8"		5 3/8"			\$ 550	PW-100J: Junior Flip up unit constructed from heavy gauge steel. An easy lift hinge allows cover to be flush with work surface when not in use. Unit complete with 2 power receptacles 15 AMP/125 Volt and 2 data Cat6 connectors. Other power and data configurations are available. Standard finish is black textured. A 72" power cord is provided.
	PW-100-MT	Surface Mount Power Station Cordset	2 3/8"		4 1/2"			\$ 488	PW-100-MT: Surface mount power station consisting of 1 power receptacle 15AMP/125 Volt and 2 USB port. Standard finish is white. A 72" power cord is provided.

Palmieri Furniture Limited ("Palmieri") warrants that its products and collections are free from defects in materials and workmanship for the life of the product, except as set forth below. Palmieri Limited Lifetime Warranty is valid from the date of delivery.

Exceptions to the Limited Lifetime Warranty: Seating: two (2) years

Goods sold hereunder are covered by a Limited Lifetime Warranty, free against defects in material and workmanship provided the goods and services are subjected to normal use and service. The applicable warranty period commences from shipping date to Purchaser of any item of the goods, whichever occurs first, or any other warranty period otherwise stipulated in writing by Palmieri under this sale. For components not supplied by Palmieri, the original manufacturer's warranty shall apply to the extent assignable by Palmieri. The obligation under this warranty is limited to the repair or replacement, at Palmieri's option, of defective parts F.O.B. point of shipment provided that prompt notice of any defect is given by Purchaser to Palmieri in writing within the applicable warranty period and that upon the Purchaser's return of the defective parts to Palmieri or, if designated by Palmieri, to the location where the works are made, properly packed and with transportation charges prepaid by Purchaser, an inspection thereof shall reveal to Palmieri's satisfaction that Purchaser's claim is valid under the terms of this warranty. Purchaser shall assume all responsibility and expense for dismantling, removal, re-installation and freight in connection with the foregoing. The same obligations and conditions extend to replacement parts furnished by Palmieri hereunder.

Palmieri does not assume liability for installation, labour or consequential damages. Palmieri makes no warranty other than the one set forth herein. All other warranties, legal, expressed or implied, including but not limited to any expressed or implied warranty of merchantability, of fitness for the intended use thereof or against infringement are hereby expressly excluded. The applicable warranty ceases to be effective if the goods are altered or repaired other than by persons authorized or approved by Palmieri to perform such work. Repairs or replacement deliveries do not interrupt or prolong the term of the warranty. The warranty ceases to be effective if Purchaser fails to handle and use the goods sold hereunder in a safe and reasonable manner and in accordance with any written instructions from the manufacturers.

Warranty Does Not Apply To Product Failure Or Loss Resulting From:

Abuse, misuse or accident, alteration or modification of product by customer or third party, normal wear and tear, improper installation, handling or incorrect use. The substitution of part components or hardware not approved or authorized by Palmieri, acts of God, unauthorized repairs, improper storage, and environmental conditions such as irregular temperature control either inside or outside the environment.

Warranty Provides Exclusive Remedies:

If a product fails under ordinary use as a result of a defect in material or workmanship, Palmieri will: (A) repair, or (B) replace the furniture. The replacement or repair of the Furniture or Seating will be at the discretion of Palmieri. If the defect or workmanship cannot be remedied on site, repairs can be made at the factory. (C) If the product repair or replacement is not commercially practicable or cannot be remade in a timely manner Palmieri will refund the purchase price of the affected product. A product "**Defect**" means: an inadequacy in the materials or workmanship of the product that (A) existed at the time when you received the product from Palmieri or Palmieri authorized Reseller and (B) causes a failure of the product to perform under ordinary use in accordance with the materials and documentation accompanying the product. "**Ordinary Use**" means: use of the product (A) in accordance with all applicable local, state or federal laws, codes and regulations and (B) in accordance with manufacturer recommendations and or instructions in the materials and documentation accompanying the product or through shop drawings. A "**Palmieri Authorized Reseller**" means: any dealer that is legally permitted to conduct business in the jurisdiction where the product is sold and is duly authorized by Palmieri to sell the product.

Warranty work must be approved by authorized personnel of Palmieri Furniture Limited in Richmond Hill, Ontario, Canada.

A copy of the original purchase order must accompany all claims.

Warranty Does Not Cover:

Matching of colours, stains, textures, grains and any other variations in materials. Select and Custom Surfaces and materials are only warranted for their application on the specified product and are not covered by our warranty, except as warranted by the original supplier, for quality, colorfastness, shade variations or abrasion and textiles purchased for Palmieri product.

This limited warranty is the sole remedy for product defect and no other express or implied warranty is provided. Warranty is not transferable and valid only for the original purchaser acquiring a product from Palmieri or a Palmieri authorized reseller for the purchaser's own use and not for resale, remarketing or distribution. Limited Lifetime Warranty (25 years)

GENERAL

The following Terms and Conditions of Quote and Sale shall apply to any sale of goods and services by Palmieri Furniture Limited (hereinafter called "Palmieri"). Purchaser shall be deemed to have full knowledge of the terms and conditions herein and such terms and conditions shall be binding if either the goods and services referred to herein are delivered to and accepted by Purchaser, or if Purchaser does not within five (5) days from the date hereof deliver to Palmieri written objection to said terms and conditions or any part thereof.

In the event of any conflict or inconsistency between the terms and conditions of sale herein and the terms and conditions contained in Purchaser's order or in any other form issued by Purchaser, whether or not any such form has been acknowledged or accepted by Palmieri, Palmieri's terms and conditions herein shall prevail. No waiver, alteration or modification of these terms and conditions shall be binding upon Palmieri unless made in writing and signed by a duly authorized representative of Palmieri.

1. QUOTATIONS / PRODUCT QUOTED

Unless otherwise stated, **Palmieri's quotations shall be null and void unless accepted by Purchaser within thirty (30) days from the date of quotation.** Quotes may be subject to change before order placement, due to increased material costs and or other factors that could impact the final cost of production and our final understanding of the product required. If the items quoted do not reflect the intended product requirements of the customer, Palmieri will not be held responsible for increased costs for those product changes. We reserve the right to edit or re-quote any portion of a previously submitted quotation subject to our final understanding of the product required by the client.

2. PALMIERI DRAWINGS

Palmieri provides drawings for Custom & Standard product we produce to our clients upon request. We consider these drawings to be Private and Confidential and are provided for the sole purpose and use of our clients to understand the product we are providing. The use of these confidential materials is limited to the transaction between the parties and at no point are these confidential materials to be sent to any of our competitors or parties quoting for the same purpose.

A minimum \$85.00 NET Engineering Administrative Fee will apply for Custom Product Drawings

(Note: The first set of Custom product drawings will be free of charge)

A minimum \$120.00 NET Engineering Administrative Fee will apply for all Standard Product Drawings

3. TERMS OF PAYMENT

For authorized customers; Orders at a \$75,000.00 threshold will require a mandatory 25% deposit. Orders over and above \$100,000.00 requires a mandatory (25%) deposit at time of order, a mandatory (25%) deposit prior to product shipment and the balance to be paid within thirty (30) days of date of shipment. Payment not be made to Palmieri when due, Palmieri reserves the right to charge Purchaser with interest on such overdue payments. Interest of 2% per month (24% per annum) is charged on all overdue accounts, unless otherwise specified. The charging of such interest shall not be construed as obligating Palmieri to grant any extension of time in the terms of payment. All goods remain the property of Palmieri, until balance is paid in full to Palmieri.

4. TITLE

Title to the goods or any part thereof shall not pass from Palmieri to Purchaser until all payments due hereunder have been duly made, except as otherwise expressly stipulated herein. The goods shall be and remain personal or moveable property, notwithstanding their mode of attachment to realty or other property. If default is made in any of the payments herein, Purchaser agrees that Palmieri may retain all payments which have been made on account of the purchase price as liquidated damages, and Palmieri shall be free to enter the premises where the goods may be located and remove them as Palmieri's property, without prejudice to Palmieri's right to recover any further expenses or damages Palmieri may suffer by reason of such nonpayment.

5. TAXES

Prices do not include Goods & Services Tax, Provincial or Municipal sales, use, value-added or similar tax. All applicable taxes are extra. Our Harmonized Sales Tax (HST) registration number is R104055066.

6. THE AGREEMENT

An acceptance and official confirmation of Purchasers' order by signing Palmieri's Order Confirmation the Purchaser therefore is accepting terms and conditions as expressed herein Palmieri's Terms and Conditions of Quote and Sale by Palmieri and shall constitute the complete agreement, subject to the terms and conditions of sale herein set forth, and shall supersede all previous quotations, orders or agreements.

7. LEAD TIME / DELIVERY / DELAYS

Lead time is determined only when final material/finish selection and drawing approvals are received by Palmieri from the client. The accuracy of Palmieri's lead times, is created to the best of our ability with the information provided to us. Confirmed lead time is conveyed to the client by means of Order Confirmation. They do not preclude the client from checking the accuracy of your requirement and our Order Confirmation. Any noted discrepancies are to be reported immediately to Palmieri Customer Service Department for correction and re-issue of revised Order Confirmation. By signing and dating the Order Confirmation the client accepts the terms and conditions of quote and sale.

Lead time on our Order Confirmation do not account for delays that could potentially occur for special materials specified by the client that are outside of our standard finishes and materials program that are out of our control

and will affect the lead time on the order. Palmieri will notify the client immediately when these delays occur and adjust the lead time accordingly.

Delivery schedules are approximate and are based on prevailing market conditions applicable respectively at the time of Palmieri's quotation and Palmieri's acceptance of clients' order, if certain portions of an order are completed by the quoted lead time while other portions have experienced delays outside of our control. The client may choose to part ship the order at their discretion and expense. Otherwise the entire order will ship with the delayed portion at a later date. Palmieri may extend delivery schedules or may, at its option, cancel Purchaser's order in full or in part without liability other than to return any deposit or prepayment which is unearned by reason of the cancellation.

8. CHANGES AND CANCELLATION

Orders accepted by Palmieri are not subject to changes or cancellation by Purchaser without the written consent of Palmieri. In such cases where Palmieri authorizes changes or cancellation, Palmieri reserves the right to charge the Purchaser with reasonable costs based upon expenses already incurred and commitments made by Palmieri, including, without limitation, any labour done, material purchased and also including Supplier's usual overhead and reasonable profit and cancellation charges from Palmieri's suppliers. Palmieri will communicate to the Purchaser additional costs incurred by way of Revised Order Confirmation. Revised Order Confirmation will include applicable costs incurred and modification to lead times (if applicable). The Purchaser must provide Palmieri written confirmation of additional costs, before any changes can be processed on the order.

A minimum charge of \$100.00 NET Change Order Request fee will apply

A minimum charge of \$150.00 NET Cancel Order Request fee will apply.

9. SHIPPING LOCATION / SHIPPING QUOTES / COST OF TRANSPORTATION

Unless otherwise stated, all prices are F.O.B. our factory in Richmond Hill, Ontario, Canada.

Customary methods of transportation shall be selected by Palmieri and such transportation will be at Purchaser's expense. Shipping quotations are made at time of furniture quotation and are outside the control of Palmieri. **Shipping quotes are valid for ten (10) business days from the time of quote.** We do our best to maintain shipping costs as quoted, however all shipping weights and cubic feet shown are approximate only, various construction materials and packaging methods may add to the weights given. All quoted prices, unless otherwise stated on the quotation, are based on the current exchange rates, tariffs, fuel surcharges and costs of manufacture and are subject to change by Palmieri with or without notice until Purchaser's acceptance. Palmieri does not assume responsibility or liability for shipping costs, product during transit, or variances from the shipping weights or cubic feet shown in our specification guides. Special methods of transportation will be used upon Purchaser's request and at Purchaser's additional expense, provided reasonable notice of Purchaser's transportation requirements are given by Purchaser to Palmieri prior to shipment. Palmieri will notify the client prior to shipping product if shipping costs as quoted change, at which point the client must approve the adjusted shipping costs.

10. RECEIVING PRODUCT / REPORTING DAMAGE / STORAGE OF PRODUCT

Upon receipt of Palmieri product, the receiver of the goods must immediately inspect the product to ensure it is free of shipping damage. If the product is deemed in good order, the receiver of the product must ensure

to sign off on the accompanying carriers Bill of lading in good condition. Except for obligations stated under "Warranty" herein, Palmieri's responsibility for the product ceases once the product has been received and signed off in good order and is the full responsibility of the receiver and subsequently the owner.

In the event shipping damage is discovered during receipt of shipment, it is the responsibility of the receiver to ensure all noted damage is recorded on the carrier's Bill of Lading prior to sign off. All noted shipping damage claims must be reported to Palmieri within **24 hours** of receipt of the product onsite, failure to do so will result in the claim being deemed null and void. All shipping damage claims are to be reported directly to Palmieri's Shipping Manager. Please call our toll free number at **1-800-413-4440 ext. 33** or submit the claim by Fax directly to **1-905-731-9878**. Palmieri will not accept any shipping damage claims submitted **after 24 hours** and it shall be conclusively presumed that the goods were delivered in good condition.

Storage of product, Palmieri will not be held responsible for any potential damages or shortages for product shipped and received by Purchaser and is subsequently placed into storage and not inspected within 24 hours of receipt.

11. INSTALLATION / SHORTAGES / BACK CHARGES

Unless otherwise expressly stipulated, the goods shall be installed by and at the risk and expense of Purchaser.

In the event that Palmieri is requested to supervise such installation, Palmieri's responsibility shall be limited to exercising that degree of skill customary in the trade in supervising installations of the same type. Purchaser shall remain responsible for all other aspects of the work including compliance with the local regulations. It is the responsibility of the Purchaser to ensure hardware and parts are received in good order. Packing slip and hardware list to be provided by Palmieri with every order at time of shipping. Purchaser has the responsibility to notify Palmieri immediately without delay of issues that arise; subsequently Palmieri will take action to provide prompt resolution.

Shortages must be reported to Palmieri within **24 hours** of receipt of the goods and failure to do so may be at the expense of the Purchaser.

If deemed missing hardware and parts short shipped from the factory, Palmieri will arrange to ship freight prepaid to destination. Palmieri will only be responsible for replacement costs of missing hardware and parts, any labour costs incurred will be the responsibility of the Purchaser and will not be approved by Palmieri.

Back Charges will only be approved if we deemed a defect in the material or workmanship is found during the installation period resulting in a return trip to the job-site to complete installation. It shall remain the sole discretion of Palmieri to approve (A) repair or (B) replace the furniture and any labour costs incurred by the Purchaser.

12. FORCE MAJEURE

Palmieri shall not be responsible or liable for any loss or damage incurred by Purchaser herein resulting from causes beyond the reasonable control of Palmieri including, but without limitation, abuse, misuse or accident, alteration or modification of product by customer or third party, normal wear and tear, improper installation, handling or incorrect use, unauthorized repairs, the substitution of part components or hardware not approved or authorized by Palmieri, improper storage, and environmental conditions such as irregular temperature control

either inside or outside the environment, acts of God, fire, flood, delays in transportation, or the failure of Palmieri's suppliers to meet their delivery promises. The acceptance of delivery of the goods by Purchaser shall constitute a waiver of all claims for loss or damage due to any delay whatsoever.

13. RETURNED GOODS

No goods may be returned to Palmieri for a credit or exchanged without Palmieri's prior written consent.

Palmieri reserves the right to accept all returns and subject to a handling/restocking charge or to decline all returns. Even after Palmieri has authorized the return of goods for credit, Palmieri reserves the right to adjust the amount of any credit given to Purchaser on return of the goods based on the conditions of the goods on arrival in Palmieri's warehouse. Credit for returned goods will be issued to Purchaser only where such goods are returned by Purchaser and not by any subsequent owner of the goods. Goods will be considered for return only if they are in their original condition and packaging. Palmieri Goods Return Authorization Form to be issued and **must** accompany all shipments returning back to the factory. **Return freight must be prepaid by Purchaser. A minimum 20% re-stocking fee will apply.**

1230 Reid Street
Richmond Hill
Ontario Canada
L4B 1C4

T 905 731 9300
F 905 731 9878
TF 800 413 4440

info@palmierifurniture.com
www.PalmieriFurniture.com







SPECIFICATION GUIDE & PRICE LIST













2017

PALMIER

SEATING

CATEGORY: LIBRARY FURNITURE
CONTRACT: BID #ESCNJ 17/18-16

Introduction	1
Table of Contents	2-5
Product Materials & Finishes	6-15
Plastic & Wood/Metal Seating	16-53
 Balloon	16-17
 Boa	16-17
 Empire	18-19
 Fast	20-21
 Fusion	22-23
 Grace	22-23
 Jade-P	24-25

 Kicca	26-29
 Manu	30-31
 Milo	32-33
 Nest	34-35
 Ongo	36-37
 Orbit	38-39
 Pasha	40-41
 Sixty	42-43
 Snow	42-43
 Tibro	44-45
 Tweet	46-49
 Vesper-S	50-51
 Web	52-53

Lounge Seating

54-69



America

54-55



Bloom

56-57



Corfu

58-59



Molecule

60-63



Penny

64-65



Pods by Dre

66-69

Wood Seating

70-91



Ambassador

70-71



Aspen

72-73



Bulldog

74-79



Henry

80-81



Hudson

82-83



Lido

84-87



Safari

88-89



Wood Stool

90-91

Warranty

92

Terms & Conditions

93

CORNERBLOCK FABRICS (J. ENNIS FABRICS):

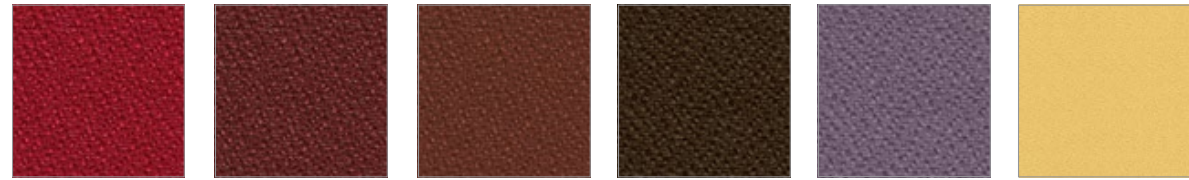

Red 14 Burgundy 108 Terracotta 405 Brown 87 Purple 1009 Gold 59

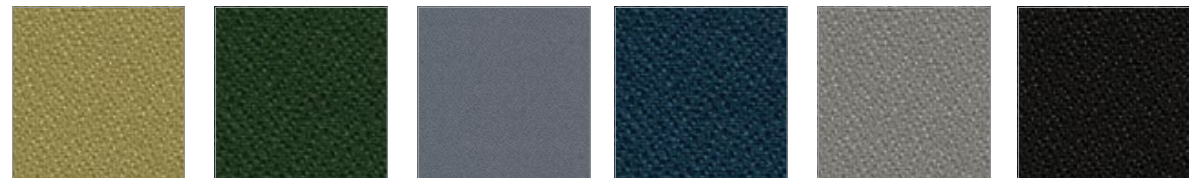

Eucalyptus 64 Green 208 Mist 32 Navy 308 Charcoal 908 Black 9009

FOUNDATION FABRICS (J. ENNIS FABRICS):



Fawn 67 Radiant Orchid 102 Lilac 105 Rosewood 108 Hemlock 202 Linen 608 Beaver 808



Wind Chime 905 Mud 908 Air 3003 Denim 3006 Zantium 3009 Old Gold 4009 Buff 6009



Saddlewood 8006 Coffee 8009 Steel 9003 Licorice 9009

CORNERBLOCK:

CONTENT: 100% Polyester
 BACKING CONTENT: 100% Acrylic
 ABRASION: Exceeds 420,000 Double Rubs: Contract Rated
 SEAM SLIPPAGE: ASTM D4034: Warp = 61 lbs Fill = 66 lbs
 TEAR STRENGTH: ASTM D2261: Warp = 54 lbs Fill = 72 lbs
 TENSILE STRENGTH: ASTM D5034: Warp = 491 lbs Fill = 364 lbs
 CROCKING: AATCC 8: Dry = Class 4.5, Wet = Class 4.5
 PILING: ASTM D3511: Class 4.5
 UV/LIGHT FASTNESS: AATCC 16: Class 4.5, 40 Hours
 FIRE RETARDANCY*: California Bulletin 117 - Section E
 UFAC Class 1, MVSS 302, NFPA 260 Class 1
 WEIGHT: 17.51 Ounces per Linear Yard
 11.06 Ounces per Square Yard
 WIDTH: 57" (145 cm)
 ROLL SIZE: 50 Yards
 CLEANING INSTRUCTIONS: S - Solvent Cleaner

FOUNDATION:

CONTENT: 100% Polyester
 BACKING CONTENT: 100% Polyester
 ABRASION: Exceeds 100,000 Double Rubs
 SEAM SLIPPAGE: ASTM D4034: Warp = 64 lbs Fill = 70 lbs
 TEAR STRENGTH: ASTM D2261: Warp = 36 lbs Fill = 24 lbs
 TENSILE STRENGTH: ASTM D5034: Warp = 335 lbs Fill = 168 lbs
 CROCKING: AATCC 8: Dry = Class 4.5, Wet = Class 4.5
 PILING: ASTM D3511: Class 4.5
 UV/LIGHT FASTNESS: AATCC 16: Class 3
 FIRE RETARDANCY*: California Bulletin 117 - Section E
 UFAC Class 1, MVSS 302, NFPA 260 Class 1
 WEIGHT: 17.75 Ounces per Linear Yard
 11.21 Ounces per Square Yard
 WIDTH: 57" (144.78 cm)
 ROLL SIZE: 55 Yards
 CLEANING INSTRUCTIONS: WC - Wash with care.

ALL FABRICS: *The term and any corresponding data refer to typical performance in the specific tests indicated and should not be construed to imply the behavior of this or any other material under actual fire conditions. This information is offered for our general information only. It's accurate to the best of our knowledge and is not intended to relieve the user from its responsibility to investigate and understand other pertinent sources of information and to comply with all laws and procedures applicable to the safe handling and use of this material. Final determination of the suitability of any product for an application rests with the user.

JOURNEY FABRICS (J. ENNIS FABRICS):



TURNER VINYL (J. ENNIS FABRICS):



JOURNEY:

CONTENT: 100% Polyester
BACKING CONTENT: 100% Acrylic
ABRASION: Exceeds 125,000 Double Rubs
SEAM SLIPPAGE: ASTM D4034: Warp = 135 lbs Fill = 130 lbs
TEAR STRENGTH: ASTM D2261: Warp = 20 lbs Fill = 17 lbs
TENSILE STRENGTH: ASTM D5034: Warp = 295 lbs Fill = 194 lbs
CROCKING: AATCC 8: Dry = Class 4.5, Wet = Class 4.5
PILING: ASTM D3511: Class 4.5
UV/LIGHT FASTNESS: ASTM D3597-02(2013)--Fading 5.0-40 hrs.
FIRE RETARDANCY*: California Bulletin 117 - Section E
 UFAC Class 1, MVSS 302, NFPA 260 Class 1
WEIGHT: 14.88 Ounces per Linear Yard
 9.74 Ounces per Square Yard
WIDTH: 55" (140 cm)
ROLL SIZE: 55 Yards
CLEANING INSTRUCTIONS: MWC - Machine Wash with care.

TURNER:

CONTENT: 100% Polyurethane
BACKING CONTENT: 70% Polyester, 30% Cotton
ABRASION: Exceeds 500,000 Double Rubs
FEATURES: Phthalate Free, PVC Free
COLD CRACK: -40°C (-40°F)
TEAR STRENGTH: ASTM D2261: Warp = 20 lbs Fill = 12 lbs
TENSILE STRENGTH: ASTM D5034: Warp = 105 lbs Fill = 74 lbs
UV/LIGHT FASTNESS: AATCC 16 Class 4.5
ELONGATION: ASTM D5034: Warp = 23.4%, Fill = 38.1%
FIRE RETARDANCY*: California Bulletin 117 - Section E
 UFAC Class 1, MVSS 302, NFPA 260 Class 1
WEIGHT: 21.18 Ounces per Linear Yard
 14.12 Ounces per Square Yard
WIDTH: 54" (140 cm)
ROLL SIZE: 30 Yards
CLEANING INSTRUCTIONS: Wipe with a soft cloth, with cold water and a mild soap. Dry immediately.

ALL FABRICS: *The term and any corresponding data refer to typical performance in the specific tests indicated and should not be construed to imply the behavior of this or any other material under actual fire conditions. This information is offered for our general information only. It's accurate to the best of our knowledge and is not intended to relieve the user from its responsibility to investigate and understand other pertinent sources of information and to comply with all laws and procedures applicable to the safe handling and use of this material. Final determination of the suitability of any product for an application rests with the user.

SIENA FABRICS (AVANT GARDE FABRICS): This fabric option is only available on Pods by Dre seating items.



SIENA:

CONTENT: 100% Polyester
 ABRASION: Exceeds 100,000 Double Rubs (Wyzenbeck)
 SEAM SLIPPAGE: ASTM D434: Warp = 3mm Fill = 3mm
 CROCKING: AATCC 8: Dry = Class 4, Wet = Class 4
 PILING: ASTM D3511: Class 5
 UV/LIGHT FASTNESS: AATCC 135: Class 5
 FIRE RETARDANCY*: CAL 117 - Section E
 UFAC Class 1, NFPA 260
 WEIGHT: 18.4 Ounces per Linear Yard
 WIDTH: 55" (140 cm)
 ROLL SIZE: 50 Yards
 CLEANING INSTRUCTIONS: WS w/ mild solvent

MESSENGER FABRICS (MAHARAM FABRICS): This fabric option is only available on Pods by Dre seating items.



MESSENGER:

CONTENT: 78% PI Recycled Polyester, 15% Polyester, 7% Nylon
 FINISHING: PFOA-Free Stain Resistant
 ABRASION: Exceeds 100,000 Double Rubs
 UV/LIGHT FASTNESS: 40+ Hours
 FIRE RETARDANCY*: CAL 117 - Section E
 UFAC Class 1, NFPA 260
 WEIGHT: 14.20 Ounces per Linear Yard
 WIDTH: 54" (137 cm)
 ROLL SIZE: 50 Yards
 CLEANING INSTRUCTIONS: WS - Clean with water-based cleanser or mild, water-free dry cleaning solvent.

SPIRIT MILLENNIUM VINYL (J.ENNIS FABRICS): This fabric option is only available on Pods by Dre seating.

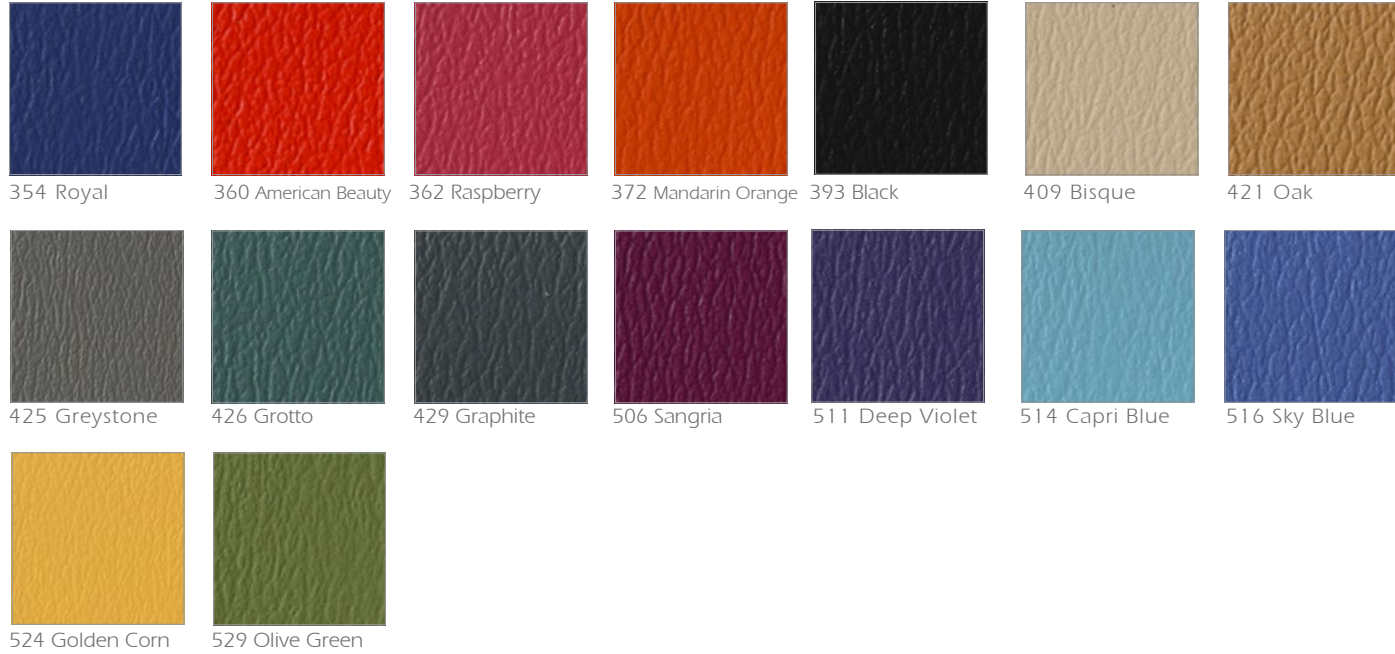

SPIRIT MILLENNIUM:

CONTENT: 100% Polyvinyl Chloride (PVC)
BACKING CONTENT: 65% Polyester, 35% Cotton
ABRASION: Exceeds 1,500,000 Double Rubs
COLD CRACK: -28°C (-18°F)
TEAR STRENGTH: ASTM D5136: Warp = 14lbs Fill = 12lbs
TENSILE STRENGTH: ASTM D5100: Warp = 65lbs Fill = 60lbs
UV/LIGHT FASTNESS: Less than 300 Hours
FIRE RETARDANCY*: CAL 117 - Sec. E
 UFAC Class 1, MVSS 302
WEIGHT: 37.00 Ounces per Linear Yard
 24.66 Ounces per Square Yard
WIDTH: 54" (137 cm)
ROLL SIZE: 30 Yards
CLEANING INSTRUCTIONS: WS w/ mild soap

MIRAGE FABRICS:

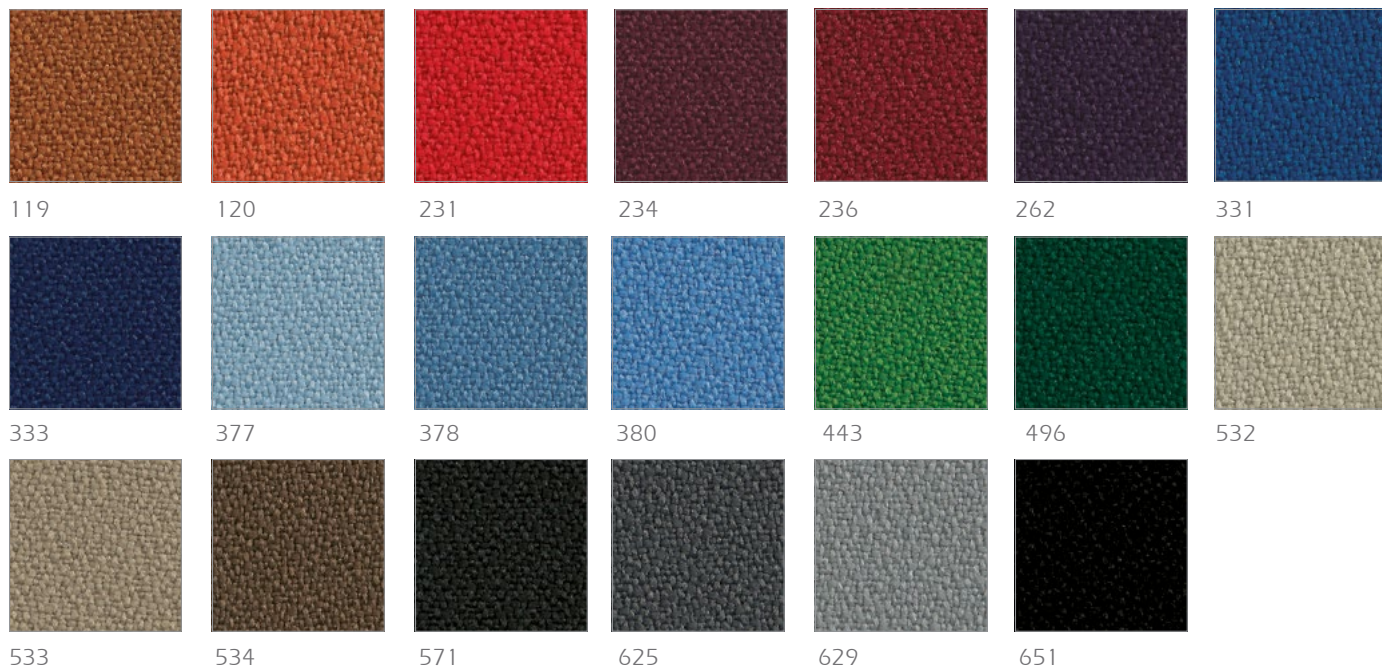

NORD WOOL FABRICS:

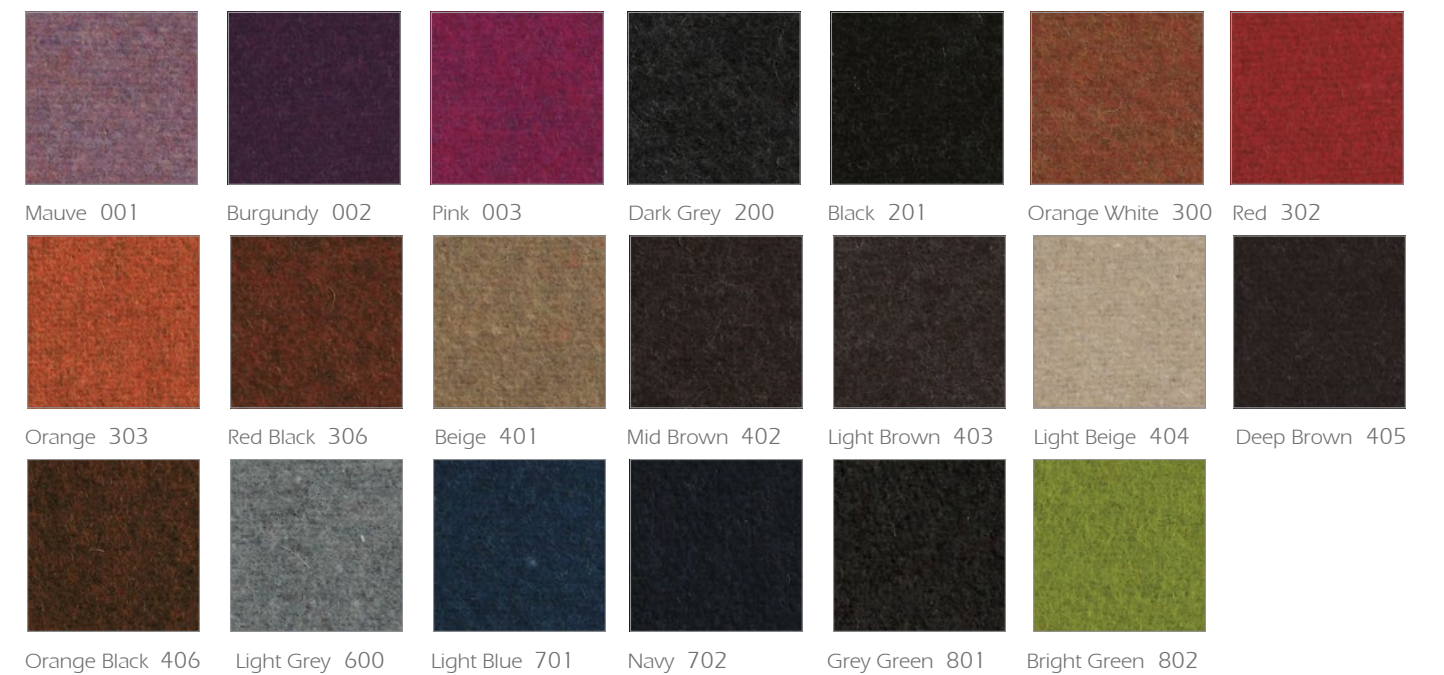

WOODS & FINISHES:

Natural Maple

Standard

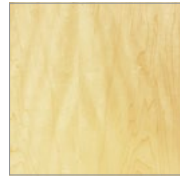

Natural Clear – M-NA

Maple Finishes

The following stains are available, add 10% to list

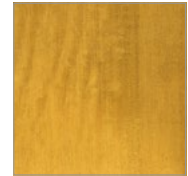

Castle Oak – M-CO

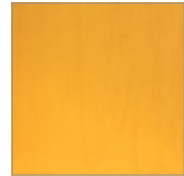

Honey Oak – M-HO

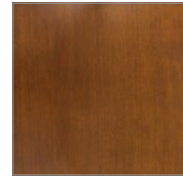

English Oak – M-EN

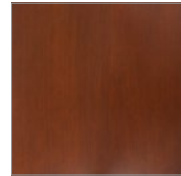

Victorian Cherry – M-VI

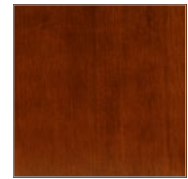

Richmond Cherry – M-RC



Mahogany – M-MA



Java – M-JA



Wenge – M-WE

Natural Red Oak

Standard

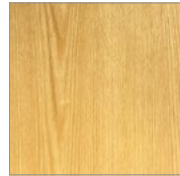

Natural Clear – O-NA

Red Oak Finishes

The following stains are available, add 10% to list

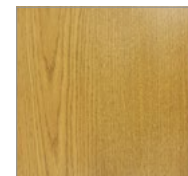

Castle Oak – O-CO

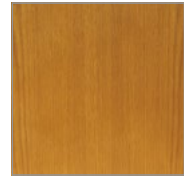

Honey Oak – O-HO

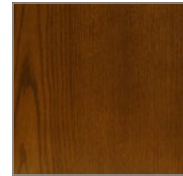

English Oak – O-EN

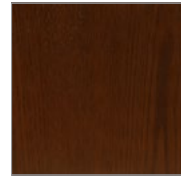

Victorian Cherry – O-VI

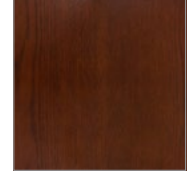

Richmond Cherry – O-RC



Mahogany – O-MA



Java – O-JA

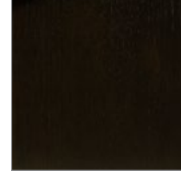

Wenge – O-WE

Natural Cherry

Add 20% to list

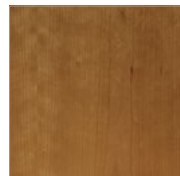

Natural Clear – C-NA

Cherry Finishes

The following stains are available, add 30% to list



Honey Oak – C-HO



Richmond Cherry – C-RC

Natural Walnut

Add 20% to list

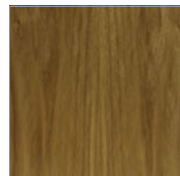

Natural Clear – W-NA

Walnut Finishes

The following stain is available, add 30% to list



Java – W-JA

METAL PAINT:

Thermal Paint Colours

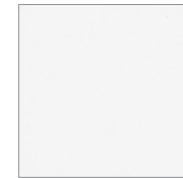

White
PS-111-W374



Antique White
W11



Beige
H23

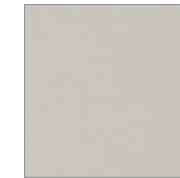

Desert
H432

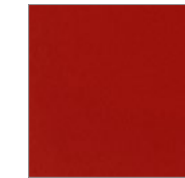

Red
R66



Ruby
R7



Blue
B11



Navy
B17

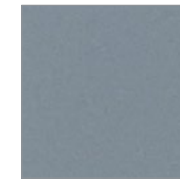

Zinc
A67

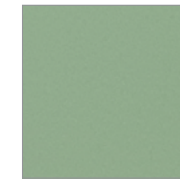

Hydro Green
G96



Green
G58

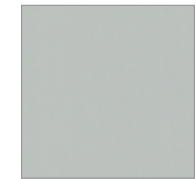

Grey
A16



Charcoal
A230



Black
N49



Pebble
M237

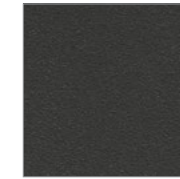

Black Sandtex
N31



Sparkling Silver
S11

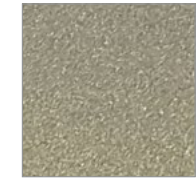

Champagne
S14

HARDWOODS: All hardwood materials used in the manufacturing of seating products shall be Northern grown hardwoods. Hardwoods will be air and kiln dried to a moisture content of 5-7%. All hardwoods shall be of grade "A" material, free of material stains, imperfections, conformity of grain, texture and color. Hardwood species shall be Northern grown Red Oak, and Clear White Northern Maple.

FINISHING PROCEDURES: All materials shall be inspected and treated with a final sanding and polishing operation before any staining and final finishing can be performed. All machine and mill marks are to be removed. Once the polishing and sanding has been performed, the furniture will then undergo the following stain and finishing procedures:





Step 1 A base stain will be uniformly applied, wiped and then allowed to dry under factory controlled conditions.





Step 2 A uniform coat of sealer will be applied and allowed to dry.







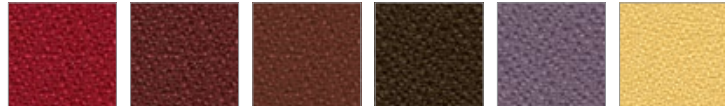

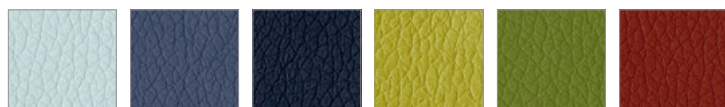



Step 3 Sealer will be lightly sanded using 240 grit silicon paper.





Step 4 A catalytic lacquer of 34-45 degree sheen is evenly applied and allowed to dry under factory controlled conditions.



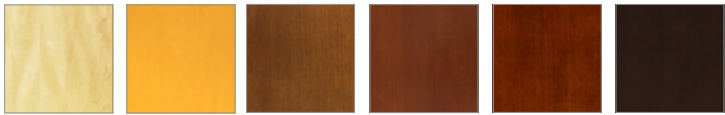
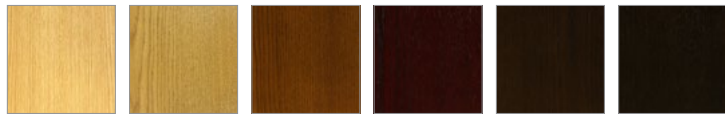

METAL FINISHING PROCEDURES: All metal components are thoroughly cleaned and coated electrostatically with an epoxy powder coat paint finish. The metal components are then oven baked and cured for a lasting finish.

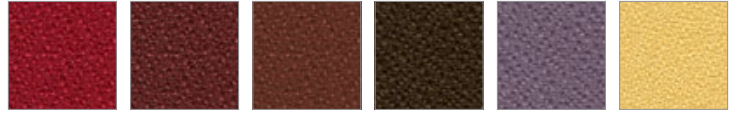
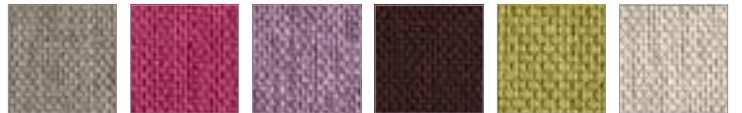
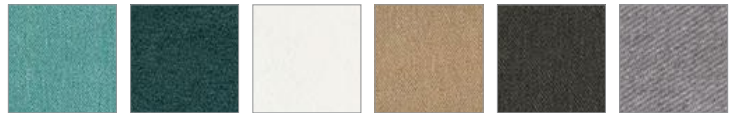

	MODEL NUMBER	NAME	SEAT HEIGHT	ARM HEIGHT	WIDTH	DEPTH	HEIGHT	FABRIC YARDS	LEATHER SQ FT	WEIGHT/VOLUME	LIST PRICE	DESCRIPTION
	BO-1-C	Balloon Chair	15"		16 ³ / ₄ "	15 ¹ / ₂ "	30"			13 Lbs 4.5 Cu Ft	\$ 719	<p>The Balloon Chair is Plywood Maple shell with steel legs epoxy coated in Silver, Red, Blue, or Yellow. Round feet options available in Blue, Black, and Red.</p> <p>For the complete line of Maple Wood Finishes and options, refer to page 14 in this specification guide.</p> 
	BOA-1	Boa Chair	18"		18"	23"	31"			13 Lbs 7.4 Cu Ft	\$ 588	<p>The Boa Chair is Plywood Maple shell seat and back with polished chrome legs. Boa is stackable up to 12 chairs high.</p> <p>For the complete line of Maple Wood Finishes and options, refer to page 14 in this specification guide.</p> 
	BOA-1-C	Boa Children's Chair	14"		16"	15"	26"			12 Lbs 3.6 Cu Ft	\$ 581	

	MODEL NUMBER	NAME	SEAT HEIGHT	ARM HEIGHT	WIDTH	DEPTH	HEIGHT	FABRIC YARDS	LEATHER SQ FT	WEIGHT/VOLUME	LIST PRICE	DESCRIPTION	
	EM-1	Empire Chair	18"		21 1/2"	22 1/2"	33"			27 Lbs 9.2 Cu Ft	\$ 881	The Empire Chair has a 7-Ply 7/16" Molded Plywood seat and back with Maple Face Veneers. Also available upholstered with Fire Retardant Foam over a 7/16" thick Molded Plywood Shell. The Frame is Cold Rolled Tubular Steel finished with an Electrostatically applied Powder Epoxy. For the complete line of Maple Wood Finishes and options, refer to page 14 in this specification guide.	
	EM-1-C	Empire Youth Chair	15"		16"	18 1/2"	28 1/2"			18 Lbs 4.9 Cu Ft	\$ 881		
	EM-1-P	Empire Primary Chair	12"		16"	18 1/2"	24"			15 Lbs 4.1 Cu Ft	\$ 831		
	EM-2	Empire Armchair	18"		21 1/2"	22 1/2"	33"			31 Lbs 9.2 Cu Ft	\$ 975	 The Empire Chair is available in a selection of 12 Cornerblock Fabrics; 18 Foundation Fabrics; 20 Journey Fabrics; or 26 Turner Vinyls. For the complete line of Cornerblock Fabrics available, refer to page 6 in this specification guide.  For the complete line of Foundation Fabrics available, refer to page 6 in this specification guide.  For the complete line of Journey Fabrics available, refer to page 8 in this specification guide.  For the complete line of Turner Vinyls available, refer to page 8 in this specification guide. 	
		Empire Chair, Upholstered	18"		21 1/2"	22 1/2"	33"			27 Lbs 9.2 Cu Ft			
	EM-1U-CB	Cornerblock Fabric									\$ 1,025		
	EM-1U-FD	Foundation Fabric									\$ 1,025		
	EM-1U-JY	Journey Fabric									\$ 1,069		
	EM-1U-TN	Turner Vinyl									\$ 1,113		
		Empire Youth Chair, Upholstered	15"		16"	18 1/2"	28 1/2"			18 Lbs 4.9 Cu Ft			
	EM-1U-C-CB	Cornerblock Fabric									\$ 1,025		
	EM-1U-C-FD	Foundation Fabric									\$ 1,025		
	EM-1U-C-JY	Journey Fabric									\$ 1,069		
	EM-1U-C-TN	Turner Vinyl									\$ 1,113		
		Empire Primary Chair, 12" Upholstered	12"		16"	18 1/2"	24"			15 Lbs 4.1 Cu Ft			
EM-1U-P-CB	Cornerblock Fabric									\$ 963			
EM-1U-P-FD	Foundation Fabric									\$ 963			
EM-1U-P-JY	Journey Fabric									\$ 1,006			
EM-1U-P-TN	Turner Vinyl									\$ 1,050			
	Empire Armchair, Upholstered	18"		21 1/2"	22 1/2"	33"			31 Lbs 9.2 Cu Ft				
EM-2U-CB	Cornerblock Fabric									\$ 1,100			
EM-2U-FD	Foundation Fabric									\$ 1,100			
EM-2U-JY	Journey Fabric									\$ 1,144			
EM-2U-TN	Turner Vinyl									\$ 1,188			







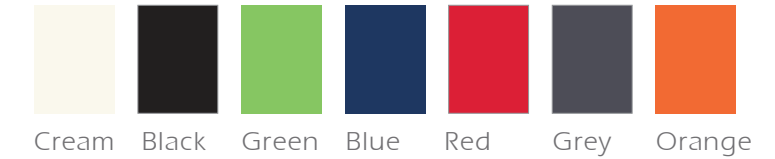

	MODEL NUMBER	NAME	SEAT HEIGHT	ARM HEIGHT	WIDTH	DEPTH	HEIGHT	FABRIC YARDS	LEATHER SQ FT	WEIGHT/ VOLUME	LIST PRICE	DESCRIPTION
	FT-1-R FT-1-B	Fast Chair R. Leather Beechwood	17 ³ / ₄ "		16 ⁷ / ₈ "	21 ⁷ / ₈ "	30 ³ / ₄ "	0.71	11.1	15.65 Lbs 6.6 Cu Ft	\$ 375 \$ 944	<p>The Fast Chair has a chrome base available with a Beechwood Shell or upholstered with R. Leather.</p> <p>There are 6 available colors for R. Leather:</p> <div style="display: flex; justify-content: space-around;"> <div style="text-align: center;"> Beige R: 8</div> <div style="text-align: center;"> Burgundy R: 3</div> <div style="text-align: center;"> Dark Brown R: 2</div> <div style="text-align: center;"> Green R: 5</div> </div> <div style="display: flex; justify-content: space-around; margin-top: 10px;"> <div style="text-align: center;"> Black R: 1</div> <div style="text-align: center;"> White R: 7</div> </div>
	FT-2-R FT-2-B	Fast Sled Base R. Leather Beechwood	18 ¹ / ₂ "		21 ⁵ / ₈ "	20 ¹ / ₂ "	31 ¹ / ₂ "	0.71	11.84	15.65 Lbs 8.1 Cu Ft	\$ 406 \$ 1,031	
	FT-3-R FT-3-B	Fast Swivel R. Leather Beechwood	19 ¹ / ₄ "		19 ¹ / ₄ "	19 ¹ / ₄ "	32 ¹ / ₄ "	0.71	11.84	13.45 Lbs 6.9 Cu Ft	\$ 488 \$ 1,263	<p>The Fast Chair is stackable up to 4-6 chairs high, and has an elegant handle in the frame located at the back of the chair.</p> <div style="display: flex; justify-content: space-around; margin-top: 10px;">   </div>
	FT-4-R	Fast Stool R. Leather	25 ⁷ / ₈ "		18 ³ / ₄ "	20 ¹ / ₈ "	36 ⁷ / ₈ "	0.71	11.1	17.67 Lbs 8.0 Cu Ft	\$ 463	

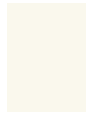

	MODEL NUMBER	NAME	SEAT HEIGHT	ARM HEIGHT	WIDTH	DEPTH	HEIGHT	FABRIC YARDS	LEATHER SQ FT	WEIGHT/VOLUME	LIST PRICE	DESCRIPTION
	FS-1-M	Fusion Chair Maple	18"		17 1/2"	20"	35"			13 Lbs 7.1 Cu Ft	\$ 831	<p>The Fusion Chair has steel legs that are available in a powder coat paint finish, see page 15 for colour options. It is constructed of Plywood Maple or Oak shell.</p> <p>For the complete line of Maple Wood Finishes and options, refer to page 14 in this specification guide.</p>  <p>For the complete line of Red Oak Wood Finishes and options, refer to page 14 in this specification guide.</p> 
	FS-1-O	Oak										
	GR-1-WH	Grace Chair White	18 1/8"		21 5/8"	20 7/8"	30 1/8"			11.24 Lbs 7.9 Cu Ft	\$ 463	<p>The Grace Chair is made of a glass fibre charged polypropylene -- matte, strong material, which is UV-beam resistant and anti-static. The legs are made of solid steel tube. The chair has a thin curved back that embraces the arms obtaining a sinuous shape.</p> <p>Grace is stackable up to 6 chairs high.</p> <p>The seat is available in the following 5 colours:</p>  <p>White Black Red Orange Light Green</p>
	GR-1-BL	Black										
	GR-1-RD	Red										
	GR-1-OR	Orange										
	GR-1-LG	Light Green										
	GR-2-WH	Grace Sled Base White	18 1/8"		21 5/8"	20 7/8"	30 1/8"			12.35 Lbs 7.9 Cu Ft	\$ 406	
	GR-2-BL	Black										
	GR-2-RD	Red										
	GR-2-OR	Orange										
	GR-2-LG	Light Green										

	MODEL NUMBER	NAME	SEAT HEIGHT	ARM HEIGHT	WIDTH	DEPTH	HEIGHT	FABRIC YARDS	LEATHER SQ FT	WEIGHT/VOLUME	LIST PRICE	DESCRIPTION
		Jade-P with Sled Base	18"	25 1/2"	24 1/4"	24 1/4"	32 1/2"	2.18	--	37.4 Lbs 11.1 Cu Ft		<p>The Jade-P Chair is available with a Chrome Frame, sled base, a Chrome Frame with 4 round legs or a Chrome Frame with 4 conic legs.</p> <p>The Jade-P Chair is available in a selection of 12 Cornerblock Fabrics; 18 Foundation Fabrics; 20 Journey Fabrics; or 26 Turner Vinyls.</p> <p>For the complete line of Cornerblock Fabrics available, refer to page 6 in this specification guide.</p>  <p>For the complete line of Foundation Fabrics available, refer to page 6 in this specification guide.</p>  <p>For the complete line of Journey Fabrics available, refer to page 8 in this specification guide.</p>  <p>For the complete line of Turner Vinyls available, refer to page 8 in this specification guide.</p> 
	JP-1-CB	Cornerblock Fabric	\$ 1,238									
	JP-1-FD	Foundation Fabric	\$ 1,238									
	JP-1-JY	Journey Fabric	\$ 1,438									
	JP-1-TN	Turner Vinyl	\$ 1,631									
		Jade-P with 4 Round Legs	18"	25 1/2"	24 1/4"	24 1/4"	32 1/2"	2.18	--	37.4 Lbs 11.1 Cu Ft		
	JP-2-CB	Cornerblock Fabric	\$ 1,069									
	JP-2-FD	Foundation Fabric	\$ 1,069									
	JP-2-JY	Journey Fabric	\$ 1,269									
	JP-2-TN	Turner Vinyl	\$ 1,463									
		Jade-P with 4 Conic Legs	18"	25 1/2"	24 1/4"	24 1/4"	32 1/2"	2.18	--	37.4 Lbs 11.1 Cu Ft		
	JP-3-CB	Cornerblock Fabric	\$ 1,575									
	JP-3-FD	Foundation Fabric	\$ 1,575									
	JP-3-JY	Journey Fabric	\$ 1,769									
	JP-3-TN	Turner Vinyl	\$ 1,969									



	MODEL NUMBER	NAME	SEAT HEIGHT	ARM HEIGHT	WIDTH	DEPTH	HEIGHT	FABRIC YARDS	LEATHER SQ FT	WEIGHT/VOLUME	LIST PRICE	DESCRIPTION
	KC-1-CR	Kicca Chair Cream	18"		21 ¹ / ₄ "	21 ⁵ / ₈ "	30"			13.2 Lbs 8.0 Cu Ft	\$ 731	The Kicca Chair has a Polypropylene Shell available with Chrome Legs, Chrome Sled Base, Black Swivel Base, Chrome Stool Base or a Standard Black Caster Base. It is available in the following 7 colours:
	KC-1-BL	Black										
	KC-1-GR	Green										
	KC-1-BU	Blue										
	KC-1-RD	Red										
	KC-1-GY	Grey										
	KC-1-OR	Orange										
		KC-2-CR										
KC-2-BL		Black										
KC-2-GR		Green										
KC-2-BU		Blue										
KC-2-RD		Red										
KC-2-GY		Grey										
KC-2-OR		Orange										
		KC-3-CR	Kicca Swivel Base Cream	18"		21 ¹ / ₄ "	21 ⁵ / ₈ "	30"			13.2Lbs 8.0 Cu Ft	\$ 1,169
	KC-3-BL	Black										
	KC-3-GR	Green										
	KC-3-BU	Blue										
	KC-3-RD	Red										
	KC-3-GY	Grey										
	KC-3-OR	Orange										





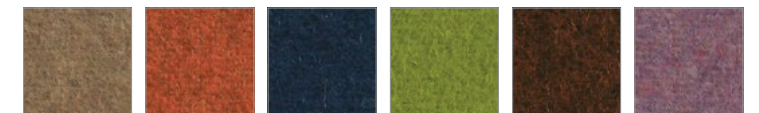
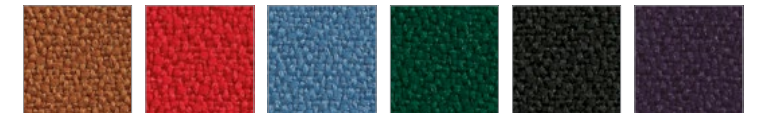











	MODEL NUMBER	NAME	SEAT HEIGHT	ARM HEIGHT	WIDTH	DEPTH	HEIGHT	FABRIC YARDS	LEATHER SQ FT	WEIGHT/VOLUME	LIST PRICE	DESCRIPTION
		Kicca Stool	28 ³ / ₈ "		21 ¹ / ₄ "	21 ⁵ / ₈ "	39 ³ / ₄ "			25 Lbs 10.6 Cu Ft	\$ 919	The Kicca Chair has a Polypropylene Shell available with Chromed Legs, Chromed Sled Base, Black Swivel Base, Chromed Stool Base or a Standard Black Caster Base. It is available in the following 7 colours: <div style="display: flex; justify-content: space-around; margin-top: 10px;">  Cream  Black  Green  Blue  Red  Grey  Orange </div> Kicca KC-5 is stackable up to 8 chairs high.
	KC-5-CR	Cream										
	KC-5-BL	Black										
	KC-5-GR	Green										
	KC-5-BU	Blue										
	KC-5-RD	Red										
	KC-5-GY	Grey										
	KC-5-OR	Orange										
		Kicca Swivel with Wheels	17 ³ / ₈ "-22"		21 ¹ / ₄ "	21 ⁵ / ₈ "	29"-33 ³ / ₄ "			25 Lbs 7.7 Cu Ft	\$ 1,050	
	KC-4-CR	Cream										
	KC-4-BL	Black										
	KC-4-GR	Green										
	KC-4-BU	Blue										
	KC-4-RD	Red										
	KC-4-GY	Grey										
	KC-4-OR	Orange										



	MODEL NUMBER	NAME	SEAT HEIGHT	ARM HEIGHT	WIDTH	DEPTH	HEIGHT	FABRIC YARDS	LEATHER SQ FT	WEIGHT/VOLUME	LIST PRICE	DESCRIPTION
	MU-1-MR	Manu Rod Mirage	18 1/2"	25"	24"	22 1/2"	30"	1.75	--	21.5 Lbs 9.4 Cu Ft	\$ 788	The Manu Chair is available with Chrome Legs or a Chromed Swivel Base available in a selection of 20 Mirage Fabrics or 20 Nord Wool Fabrics. For the complete line of Mirage Fabrics available, refer to page 12 in this specification guide.
	MU-1-NW	Nord Wool									\$ 881	
	MU-2-MR	Manu-G with Round Swivel Base Mirage	18 1/2"	25"	26"	22 1/2"	30"	1.75	--	20 Lbs 10.2 Cu Ft	\$ 1,556	For the complete line of Nord Wool Fabrics available, refer to page 13 in this specification guide.
	MU-2-NW	Nord Wool									\$ 1,650	











	MODEL NUMBER	NAME	SEAT HEIGHT	ARM HEIGHT	WIDTH	DEPTH	HEIGHT	FABRIC YARDS	LEATHER SQ FT	WEIGHT/VOLUME	LIST PRICE	DESCRIPTION
	MI-1	Milo Chair	18"		22"	20"	33"			13 Lbs 8.4 Cu Ft	\$ 606	<p>The Milo Chair is available with Polished Chrome Legs or a 5 Star Black Polypropylene Base. It has a Plywood Maple shell seat and back.</p> <p>For the complete line of Maple Wood Finishes and options, refer to page 14 in this specification guide.</p> 
	MI-4	Milo Swivel Armchair	16" - 21"	24" - 29"	24"	24"	29" - 34"			20 Lbs 9.7 Cu Ft	\$ 781	<p>Milo chair is stackable up to 12 chairs high.</p>



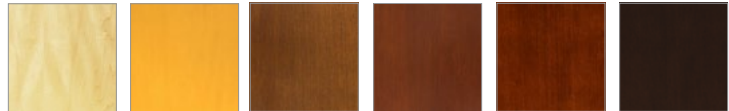

	MODEL NUMBER	NAME	SEAT HEIGHT	ARM HEIGHT	WIDTH	DEPTH	HEIGHT	FABRIC YARDS	LEATHER SQ FT	WEIGHT/VOLUME	LIST PRICE	DESCRIPTION
	NT-1-BL NT-1-GY	Nest Chair Black Grey	17 1/2"		17 1/2"	17"	32"			8 Lbs 5.5 Cu Ft	\$ 331	<p>The Nest Chair is constructed with a Polypropylene Shell and Metal Frame with sled base. The back of the chair has small holes for ventilation. The chair is available in Grey or Black color ONLY.</p> <div style="display: flex; justify-content: space-around; align-items: center;"> <div style="text-align: center;">  Black </div> <div style="text-align: center;">  Grey </div> </div>
	NT-2-BL NT-2-GY	Nest Armchair Black Grey	17 1/2"		17 1/2"	17"	32"			10 Lbs 5.5 Cu Ft	\$ 456	
	NT-3-BL NT-3-GY	Nest Chair, with Tablet Arm ONLY Black Grey	17 1/2"		17 1/2"	17"	32"			10 Lbs 5.5 Cu Ft	\$ 713	
	NT-3B-BL NT-3B-GY	Nest Chair, with Tablet Arm, AND Under Basket Black Grey	17 1/2"		17 1/2"	17"	32"			11 Lbs 5.5 Cu Ft	\$ 938	
	NT-4-BL NT-4-GY	Nest Barstool Black Grey	28 1/2"		17 1/2"	17 1/2"	43"			14 Lbs 5.5 Cu Ft	\$ 613	



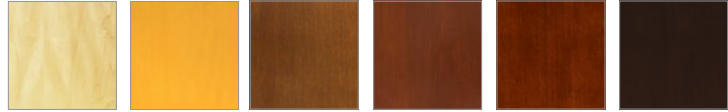

	MODEL NUMBER	NAME	SEAT HEIGHT	ARM HEIGHT	WIDTH	DEPTH	HEIGHT	FABRIC YARDS	LEATHER SQ FT	WEIGHT/VOLUME	LIST PRICE	DESCRIPTION
		Ongo Stool White Base	16 1/2"-25"		14"	14"		--	--	12.6 Lbs 2.2 Cu Ft	\$ 1,186	The Ongo Stool has an ABS Plastic Base available in two colours, black or white.
	ON-1-BL	Black Seat										<p>Comes with 3 interchangeable balls (steel, glass, and rubber) to vary the level of difficulty for your exercises with the ball track</p> <p>The Ongo Stool is height adjustable a from 16 1/2" seat height up to 25".</p> <p>The Ongo Stool is available in the following 12 Colours of Microfiber Knit Fabrics:</p> 
	ON-1-VO	Violet Seat										
	ON-1-BR	Brown Seat										
	ON-1-GY	Grey Seat										
	ON-1-RD	Red Seat										
	ON-1-OR	Orange Seat										
	ON-1-LB	Light Blue Seat										
	ON-1-BU	Blue Seat										
	ON-1-GR	Green Seat										
	ON-1-LG	Light Green Seat										
	ON-1-PR	Purple Seat										
	ON-1-DR	Dark Red Seat										
		Ongo Stool Black Base	16 1/2"-25"		14"	14"		--	--	12.6 Lbs 2.2 Cu Ft	\$ 1,186	
	ON-2-BL	Black Seat										
	ON-2-VO	Violet Seat										
	ON-2-BR	Brown Seat										
	ON-2-GY	Grey Seat										
	ON-2-RD	Red Seat										
	ON-2-OR	Orange Seat										
	ON-2-LB	Light Blue Seat										
	ON-2-BU	Blue Seat										
	ON-2-GR	Green Seat										
	ON-2-LG	Light Green Seat										
	ON-2-PR	Purple Seat										
	ON-2-DR	Dark Red Seat										
	ON-K-PB	Ongo Kit Stool Purple/Light Blue	12"		14"	14"		--	--	6 Lbs 1.4 Cu Ft	\$ 539	The Ongo Kit is suitable for young children. It consists of a curved base and large integrated ball track.
	ON-K-OP	Orange/Petrol										<p>Adjust the height of the Ongo Kit with the separate height extension kit. Each kit comes with 2 height extensions in 3" increments.</p> <p>The Ongo Kit is available in 3 combination colours only:</p> 
	ON-K-BA	Beige/Anthracite										
		Ongo Kit with Column Extension	15"-18"		14"	14"		--	--	6 Lbs 1.7 Cu Ft	\$ 633	
	ON-KCE-PB	Purple/Light Blue										
	ON-KCE-OP	Orange/Petrol										
ON-KCE-BA	Beige/Anthracite											
		Column Extensions for Ongo Kit (2/box)						--	--	1 Lbs	\$ 94	
	ON-CE-P	Purple										
	ON-CE-O	Orange										
ON-CE-B	Beige											

	MODEL NUMBER	NAME	SEAT HEIGHT	ARM HEIGHT	WIDTH	DEPTH	HEIGHT	FABRIC YARDS	LEATHER SQ FT	WEIGHT/VOLUME	LIST PRICE	DESCRIPTION
	OR-1-BU OR-1-RD OR-1-GR OR-1-CH OR-1-OR	Orbit Chair Blue Red Green Charcoal Orange	18"		18"	15"	31"			12.6 Lbs 4.8 Cu Ft	\$ 669	The Orbit Chair is constructed of a Polypropylene Shell with Polished Chrome Legs available in the following 5 Colours:  Blue Red Green Charcoal Orange The Orbit Chair is stackable up to 8 chairs high.
	OR-1C-BU OR-1C-RD OR-1C-GR OR-1C-CH OR-1C-OR	Orbit Children's Chair 14" Blue Red Green Charcoal Orange			13 1/2"	11"	25"			8.8 Lbs 2.1 Cu Ft	\$ 544	

	MODEL NUMBER	NAME	SEAT HEIGHT	ARM HEIGHT	WIDTH	DEPTH	HEIGHT	FABRIC YARDS	LEATHER SQ FT	WEIGHT/VOLUME	LIST PRICE	DESCRIPTION
	PA-1-WH	White Chair	17"	25 ³ / ₄ "	28"	29 ¹ / ₂ "	38 ¹ / ₂ "			21.4 Lbs 18.4 Cu Ft	\$ 1,200	The Pasha Collection is made from an Injection Molded Polycarbonate Shell available in 4 Colours: White, Black, Transparent, and Smoke Translucent.
	PA-1-BL	Black Chair										
	PA-1-TR	Transparent Chair										
	PA-1-TRS	Smoke Translucent Chair										
 Cushion Only	PA-C1-BL	Velvet Cushion Black			22 ¹ / ₂ "	22"	4"			2.6 Lbs 1.1 Cu Ft	\$ 594	The Cushion is available in a Fire Retardant Velvet in Black or White; a Fire Retardant Fabric in Black or White; Black and Grey Plaid; or White and Grey Stripes.
	PA-C1-WH	White									\$ 594	
	PA-C2-BL	Plain Cushion Black									\$ 700	
	PA-C2-WH	White									\$ 700	
	PA-C3	Plaid Cushion White/Black									\$ 913	
PA-C4	Stripe Cushion White/Grey									\$ 913		
	PA-2-WH	White Ottoman			23 ⁵ / ₈ "	20"	16"			11 Lbs 4.4 Cu Ft	\$ 544	
	PA-2-BL	Black Ottoman										
	PA-2-TR	Transparent Ottoman										
	PA-2-TRS	Smoke Translucent Ottoman										
 Ottoman Tray Only	PA-T-WH	White Ottoman Tray			17 ¹ / ₂ "	13 ¹ / ₄ "	2 ³ / ₄ "			3.5 Lbs 0.4 Cu Ft	\$ 319	
	PA-T-BL	Black Ottoman Tray										

	MODEL NUMBER	NAME	SEAT HEIGHT	ARM HEIGHT	WIDTH	DEPTH	HEIGHT	FABRIC YARDS	LEATHER SQ FT	WEIGHT/VOLUME	LIST PRICE	DESCRIPTION
	SI-1	Sixty Chair	18 ¹ / ₈ "		16 ¹ / ₂ "	22 ¹ / ₄ "	32 ¹ / ₄ "			11.63 Lbs 6.9 Cu Ft	\$ 681	<p>The Sixty chair has steel legs that are available in a powder coat paint finish, see page 15 for colour options. It is constructed of Plywood Maple shell.</p> <p>For the complete line of Maple Wood Finishes and options, refer to page 14 in this specification guide.</p> 
	SN-1-WH SN-1-SA SN-1-GY SN-1-BL SN-1-RD SN-1-OR SN-1-GR SN-1-BU	Snow Chair White Sand Grey Black Red Orange Green Blue	17 ⁷ / ₈ "		18 ¹ / ₂ "	21 ⁵ / ₈ "	31 ⁵ / ₈ "			9.9 Lbs 7.3 Cu Ft	\$ 294	<p>The Snow is made from injected polypropylene, lightweight and UV rays resistant. The chair is ideal for both indoor and outdoor use. It also has a water outflow hold on the back of the seat. Snow is also stackable 8 chairs high and is available in the following 8 colours: (Minimum order quantity: 25 pcs.)</p>  <p>White Sand Grey Black Red Orange Green Blue</p>
	SN-2-WH SN-2-LB SN-2-PK SN-2-YE SN-2-RD	Snow Junior Chair White Light Blue Pink Yellow Red	13 ³ / ₄ "		16 ¹ / ₂ "	17 ⁵ / ₈ "	24 ⁵ / ₈ "			6.6 Lbs 4.1 Cu Ft	\$ 277	<p>Snow Junior chair is available in the following 5 colours: (Minimum Order quantity: 25 pcs.)</p>  <p>White Light Blue Pink Yellow Red</p>

	MODEL NUMBER	NAME	SEAT HEIGHT	ARM HEIGHT	WIDTH	DEPTH	HEIGHT	FABRIC YARDS	LEATHER SQ FT	WEIGHT/VOLUME	LIST PRICE	DESCRIPTION
	TB-1-M	Tibro Maple	18"		21"	21"	34"			14 Lbs 8.7 Cu Ft	\$ 631	The Tibro Chair comes with Sandtex Black Legs or a 5-Star Black Polypropylene Base. It has a Plywood Maple shell available in standard Natural Clear Finish. For the complete line of Maple Wood Finishes and options, refer to page 14 in this specification guide.
	TB-2-M	Tibro Armchair Maple	18"	25"	21"	21"	34"			14 Lbs 8.7 Cu Ft	\$ 856	 Tibro TB-1 & TB-2 are stackable up to 12 chairs high.
	TB-3-M	Tibro Swivel Maple	16" - 21"		24"	24"	29" - 34"			15 Lbs 8.5 Cu Ft	\$ 631	

	MODEL NUMBER	NAME	SEAT HEIGHT	ARM HEIGHT	WIDTH	DEPTH	HEIGHT	FABRIC YARDS	LEATHER SQ FT	WEIGHT/VOLUME	LIST PRICE	DESCRIPTION
	TW-1-BL TW-1-RD TW-1-GR TW-1-OR TW-1-YE TW-1-GY TW-1-DC	Tweet Chair Black/White Red/White Green/White Orange/White Yellow/White Grey/White Dark Charcoal/White	18"		21 ¹ / ₄ "	20 ³ / ₄ "	31 ³ / ₄ "			11.25 Lbs 8.1 Cu Ft	\$ 644	Polypropylene Shell: Front is white matte finished, scratch-resistant & Back is gloss finished and available in 7 colours:
	TW-7-BL TW-7-RD TW-7-GR TW-7-OR TW-7-YE TW-7-GY TW-7-DC	Tweet Armchair Black/White Red/White Green/White Orange/White Yellow/White Grey/White Dark Charcoal/White	18"	25 ³ / ₄ "	22 ³ / ₄ "	20 ¹ / ₂ "	31 ³ / ₄ "			13.75 Lbs 8.6 Cu Ft	\$ 994	Metal frame are all round-tubed and polished chrome.
	TW-3-BL TW-3-RD TW-3-GR TW-3-OR TW-3-YE TW-3-GY TW-3-DC	Tweet Sled Base Chair Black/White Red/White Green/White Orange/White Yellow/White Grey/White Dark Charcoal/White	18"		20 ³ / ₄ "	20 ¹ / ₂ "	31 ³ / ₄ "			13.75 Lbs 7.8 Cu Ft	\$ 688	
	TW-8-BL TW-8-RD TW-8-GR TW-8-OR TW-8-YE TW-8-GY TW-8-DC	Tweet Sled Base Armchair Black/White Red/White Green/White Orange/White Yellow/White Grey/White Dark Charcoal/White	18"	25 ¹ / ₂ "	22"	20 ¹ / ₂ "	31 ¹ / ₂ "			16.25 Lbs 8.2 Cu Ft	\$ 1,031	









Metal frame are all round-tubed and polished chrome.

Tweet TW-1, TW-7, TW-3 & TW-8 are stackable up to 10 chairs high.



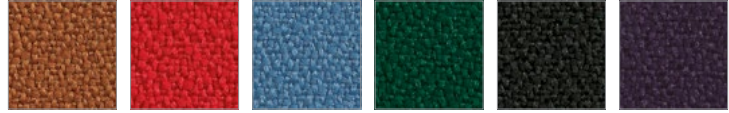
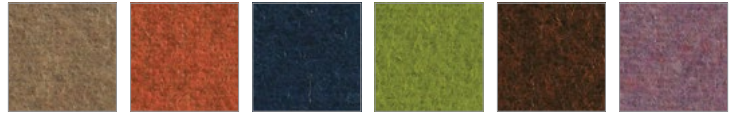













	MODEL NUMBER	NAME	SEAT HEIGHT	ARM HEIGHT	WIDTH	DEPTH	HEIGHT	FABRIC YARDS	LEATHER SQ FT	WEIGHT/VOLUME	LIST PRICE	DESCRIPTION	
		Tweet Stool	29 1/2"		20 1/2"	20 3/4"	43"			16.25 Lbs 10.6 Cu Ft	\$ 881	Polypropylene Shell: Front is white matte finished, scratch-resistant & Back is gloss finished and available in 7 colours:	
	TW-5-BL	Black/White											
	TW-5-RD	Red/White											
	TW-5-GR	Green/White											
	TW-5-OR	Orange/White											
	TW-5-YE	Yellow/White											
	TW-5-GY	Grey/White											
	TW-5-DC	Dark Charcoal/White											
		Tweet Sled Base Stool	29 1/2"		22 1/2"	21 1/4"	43 1/4"			17.5 Lbs 12.0 Cu Ft	\$ 831	Metal frame are all round-tubed and polished chrome. Tweet TW-5 is stackable up to 8 chairs high. Tweet TW-6 is stackable up to 4 chairs high.	
	TW-6-BL	Black/White											
	TW-6-RD	Red/White											
	TW-6-GR	Green/White											
	TW-6-OR	Orange/White											
	TW-6-YE	Yellow/White											
	TW-6-GY	Grey/White											
	TW-6-DC	Dark Charcoal/White											

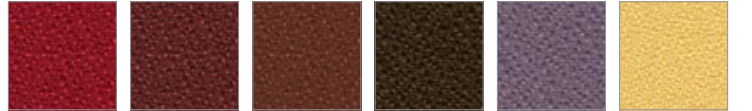

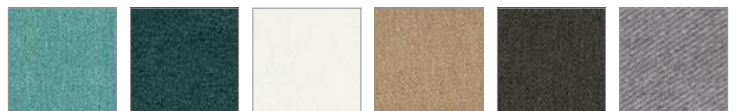



	MODEL NUMBER	NAME	SEAT HEIGHT	ARM HEIGHT	WIDTH	DEPTH	HEIGHT	FABRIC YARDS	LEATHER SQ FT	WEIGHT/VOLUME	LIST PRICE	DESCRIPTION
	VS-1-MR VS-1-NW	Vesper-S Chair Mirage Nord Wool	18 1/2"		18 7/8"	20 1/2"	33 1/8"	0.77	--	14.33 Lbs 7.4 Cu Ft	\$ 481 \$ 525	The Vesper-S Chair is available with a Chrome Frame available in a selection of 20 Mirage Fabrics or 20 Nord Wool Fabrics.
	VS-1-VK1-MR VS-1-VK1-NW	Vesper with 1 Pair of Linking Devices (left + right) Mirage Nord Wool	18 1/2"		18 7/8"	20 1/2"	33 1/8"	0.77	--	15.33 Lbs 7.4 Cu Ft	\$ 519 \$ 563	For the complete line of Mirage Fabrics available, refer to page 12 in this specification guide.  For the complete line of Nord Wool Fabrics available, refer to page 13 in this specification guide. 
	VS-1-VK2-MR VS-1-VK2-NW	Vesper with 1 Arm (left or right) Mirage Nord Wool	18 1/2"	26 1/8"	18 7/8"	20 1/2"	33 1/8"	0.77	--	15.33 Lbs 7.4 Cu Ft	\$ 563 \$ 613	The Arm (VK2) and the Arm & Writing Table (VK3) additions both require a minimum quantity order of 20.
	VS-1-VK3-MR VS-1-VK3-NW	Vesper with 1 Arm with Writing Table (left or right) Mirage Nord Wool	18 1/2"	26 1/8"	18 7/8"	20 1/2"	33 1/8"	0.77	--	15.33 Lbs 7.4 Cu Ft	\$ 656 \$ 706	
	VS-1-VK4-MR VS-1-VK4-NW	Vesper Armchair Chromed Arm Mirage Nord Wool	18 1/2"	26 1/8"	18 7/8"	20 1/2"	33 1/8"	0.77	--	14.33 Lbs 7.4 Cu Ft	\$ 650 \$ 694	
	VK5	Vesper Trolley for 20 Chairs						N/A	--		\$ 631	

SEATING

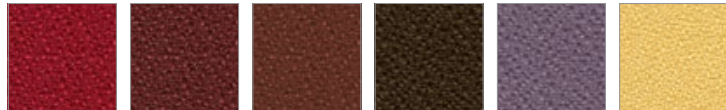
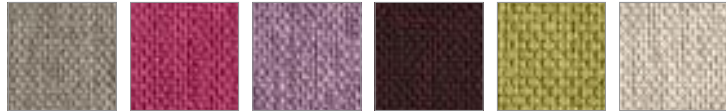
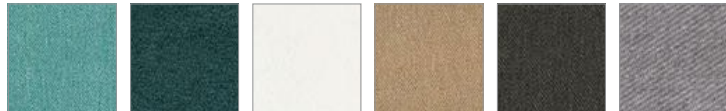
	MODEL NUMBER	NAME	SEAT HEIGHT	ARM HEIGHT	WIDTH	DEPTH	HEIGHT	FABRIC YARDS	LEATHER SQ FT	WEIGHT/VOLUME	LIST PRICE	DESCRIPTION
	WEB-1-BL WEB-1-CR WEB-1-BU WEB-1-RD WEB-1-GR	Web Chair with Plastic Seat and Back Black Cream Blue Red Green	18 ¹ / ₈ "		22 ⁵ / ₈ "	20 ¹ / ₈ "	32 ⁵ / ₈ "			13.22 Lbs 8.6 Cu Ft	\$ 344	The Web Chair has a Chrome Frame Sled Base with a Plastic Seat and Back as well as a Mesh Back with Plastic Seat option. The Mesh Back is available in Black ONLY. It is available in the following 5 colours:
												 Red Green Blue Cream Black
	WEB-2-BL WEB-2-CR	Web Chair with Mesh Black Back Black Seat Cream Seat	18 ¹ / ₈ "		22 ⁵ / ₈ "	20 ¹ / ₈ "	32 ⁵ / ₈ "			13.22 Lbs 8.6 Cu Ft	\$ 406	Web has a minimum quantity order of 20 chairs for both models.
	WEB-3	Web Stacking Trolley, Black ONLY			25 ³ / ₄ "	29 ⁴ / ₅ "	20"			24.2 Lbs 8.9 Cu Ft	\$ 1,919	The Web Chair is stackable up to 10 chairs high without a trolley. With the proper chair trolley, Web can be stacked approximately 40 chairs high. But it is recommended that the chairs be stacked 25 chairs high with a trolley for better stability.
												

	MODEL NUMBER	NAME	SEAT HEIGHT	ARM HEIGHT	WIDTH	DEPTH	HEIGHT	FABRIC YARDS	LEATHER SQ FT	WEIGHT/ VOLUME	LIST PRICE	DESCRIPTION
	AM-1-CB AM-1-FD AM-1-JY AM-1-TN	America - 1 Seater Cornerblock Fabric Foundation Fabric Journey Fabric Turner Vinyl	18 ¹ / ₈ "		31 ¹ / ₂ "	29 ¹ / ₂ "	33 ¹ / ₂ "	2.62	--	38.58 Lbs 18 Cu Ft	\$ 1,568 \$ 1,568 \$ 1,660 \$ 1,769	<p>The America Series is available in a selection of 12 Cornerblock Fabrics; 18 Foundation Fabrics; 20 Journey Fabrics; or 26 Turner Vinyls.</p> <p>For the complete line of Cornerblock Fabrics available, refer to page 6 in this specification guide.</p>  <p>For the complete line of Foundation Fabrics available, refer to page 6 in this specification guide.</p>  <p>For the complete line of Journey Fabrics available, refer to page 8 in this specification guide.</p>  <p>For the complete line of Turner Vinyls available, refer to page 8 in this specification guide.</p> 
	AM-2-CB AM-2-FD AM-2-JY AM-2-TN	America - 2 Seater Cornerblock Fabric Foundation Fabric Journey Fabric Turner Vinyl	18 ¹ / ₈ "		47 ¹ / ₄ "	29 ¹ / ₂ "	33 ¹ / ₂ "	3.39	--	55.12 Lbs 27 Cu Ft	\$ 1,926 \$ 1,926 \$ 2,020 \$ 2,229	
	AM-3-CB AM-3-FD AM-3-JY AM-3-TN	America - 3 Seater Cornerblock Fabric Foundation Fabric Journey Fabric Turner Vinyl	18 ¹ / ₈ "		70 ⁷ / ₈ "	29 ¹ / ₂ "	33 ¹ / ₂ "	4.7	--	78.3 Lbs 40.5 Cu Ft	\$ 2,451 \$ 2,451 \$ 2,559 \$ 2,890	
	AM-4-CB AM-4-FD AM-4-JY AM-4-TN	America - Corner Cornerblock Fabric Foundation Fabric Journey Fabric Turner Vinyl	18 ¹ / ₈ "		29 ¹ / ₂ "	29 ¹ / ₂ "	33 ¹ / ₂ "	3.17	--	45 Lbs 16.9 Cu Ft	\$ 1,876 \$ 1,876 \$ 1,970 \$ 2,078	
	AM-5-CB AM-5-FD AM-5-JY AM-5-TN	America Ottoman Cornerblock Fabric Foundation Fabric Journey Fabric Turner Vinyl	18 ¹ / ₈ "		29 ¹ / ₂ "	29 ¹ / ₂ "	18 ¹ / ₈ "	1.64	--	27.56 Lbs 9.1s Cu Ft	\$ 1,258 \$ 1,258 \$ 1,330 \$ 1,424	

	MODEL NUMBER	NAME	SEAT HEIGHT	ARM HEIGHT	WIDTH	DEPTH	HEIGHT	FABRIC YARDS	LEATHER SQ FT	WEIGHT/VOLUME	LIST PRICE	DESCRIPTION
	BL-1-CB BL-1-FD BL-1-JY BL-1-TN	Bloom Round Cornerblock Fabric Foundation Fabric Journey Fabric Turner Vinyl			16 ³ / ₄ "	16 ³ / ₄ "	16 ³ / ₄ "	1.5	--	6.6 Lbs 2.7 Cu Ft	\$ 518 \$ 518 \$ 568 \$ 596	<p>The Bloom series is available in a selection of 12 Cornerblock Fabrics; 18 Foundation Fabrics; 20 Journey Fabrics or 26 Turner Vinyls.</p> <p>For the complete line of Cornerblock Fabrics available, refer to page 6 in this specification guide.</p>  <p>For the complete line of Foundation Fabrics available, refer to page 6 in this specification guide.</p>  <p>For the complete line of Journey Fabrics available, refer to page 8 in this specification guide.</p>  <p>For the complete line of Turner Vinyls available, refer to page 8 in this specification guide.</p> 
	BL-2-CB BL-2-FD BL-2-JY BL-2-TN	Bloom Moon Cornerblock Fabric Foundation Fabric Journey Fabric Turner Vinyl			16 ³ / ₄ "	16 ³ / ₄ "	16 ³ / ₄ "	1.5	--	6.4 Lbs 2.7 Cu Ft	\$ 596 \$ 596 \$ 647 \$ 676	
	BL-3-CB BL-3-FD BL-3-JY BL-3-TN	Bloom 2 Seater Cornerblock Fabric Foundation Fabric Journey Fabric Turner Vinyl			47 ⁵ / ₈ "	24 ⁵ / ₈ "	16 ³ / ₄ "	2.85	--	22 Lbs 11.4 Cu Ft	\$ 1,388 \$ 1,388 \$ 1,509 \$ 1,581	





MODEL NUMBER	NAME	SEAT HEIGHT	ARM HEIGHT	WIDTH	DEPTH	HEIGHT
CO-1-CB	Corfu 1 Seater Cornerblock Fabric	16 1/8"		37 3/8"	31 1/2"	25 1/4"
CO-1-FD	Foundation Fabric					
CO-1-JY	Journey Fabric					
CO-1-TN	Turner Vinyl					

FABRIC YARDS	LEATHER SQ FT	WEIGHT/ VOLUME	LIST PRICE
3.83	--	61.73 Lbs 17.2 Cu Ft	\$ 1,776
			\$ 1,776
			\$ 1,885
			\$ 2,009

DESCRIPTION
The Corfu series is available in a selection of 12 Cornerblock Fabrics; 18 Foundation Fabrics; 20 Journey Fabrics or 26 Turner Vinyls.

For the complete line of Cornerblock Fabrics available, refer to page 6 in this specification guide.



CO-2-CB	Corfu 2 Seater Cornerblock Fabric	16 1/8"		59 1/8"	31 1/2"	25 1/4"
CO-2-FD	Foundation Fabric					
CO-2-JY	Journey Fabric					
CO-2-TN	Turner Vinyl					

5.36	--	79.37 Lbs 27.2 Cu Ft	\$ 2,191
			\$ 2,191
			\$ 2,299
			\$ 2,538

For the complete line of Foundation Fabrics available, refer to page 6 in this specification guide.

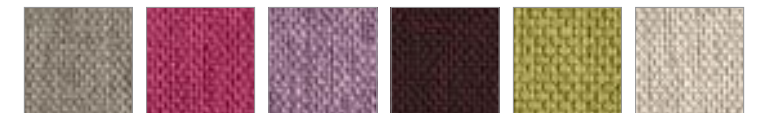

CO-3-CB	Corfu 3 Seater Cornerblock Fabric	16 1/8"		78"	31 1/2"	25 1/4"
CO-3-FD	Foundation Fabric					
CO-3-JY	Journey Fabric					
CO-3-TN	Turner Vinyl					





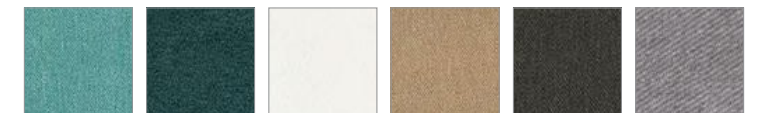



7.22	--	94.8 Lbs 35.9 Cu Ft	\$ 2,828
			\$ 2,828
			\$ 2,951
			\$ 3,339

For the complete line of Journey Fabrics available, refer to page 8 in this specification guide.



For the complete line of Turner Vinyls available, refer to page 8 in this specification guide.



MODEL NUMBER	NAME	SEAT HEIGHT	ARM HEIGHT	WIDTH	DEPTH	HEIGHT	FABRIC YARDS	LEATHER SQ FT	WEIGHT/VOLUME	LIST PRICE
	RECTANGLE;									
	ML-11-CB	24" Width Cornerblock Fabric		23 ⁵ / ₈ "	30 ¹ / ₄ "	20"	2.3	--	39 Lbs 8.3 Cu Ft	\$ 1,539
	ML-11-FD	Foundation Fabric								\$ 1,539
	ML-11-JY	Journey Fabric								\$ 1,659
ML-11-TN	Turner Vinyl									\$ 1,790
	ML-12-CB	48" Width Cornerblock Fabric		47 ¹ / ₄ "	30 ¹ / ₄ "	20"	2.75	--	45.5 Lbs 16.5 Cu Ft	\$ 2,020
	ML-12-FD	Foundation Fabric								\$ 2,020
	ML-12-JY	Journey Fabric								\$ 2,221
	ML-12-TN	Turner Vinyl								\$ 2,423
	ML-13-CB	71" Width Cornerblock Fabric		70 ³ / ₄ "	30 ¹ / ₄ "	20"	3.3	--	55 Lbs 24.8 Cu Ft	\$ 2,580
	ML-13-FD	Foundation Fabric								\$ 2,580
	ML-13-JY	Journey Fabric								\$ 2,824
	ML-13-TN	Turner Vinyl								\$ 3,076
	RECTANGLE, 1 SEMI-CIRCLE END;									
	ML-21-CB	24" Width Cornerblock Fabric		23 ⁵ / ₈ "	30 ¹ / ₄ "	20"	2.5	--	42 Lbs 8.3Cu Ft	\$ 1,683
	ML-21-FD	Foundation Fabric								\$ 1,683
	ML-21-JY	Journey Fabric								\$ 1,798
ML-21-TN	Turner Vinyl									\$ 1,926
	ML-22-CB	48" Width Cornerblock Fabric		47 ¹ / ₄ "	30 ¹ / ₄ "	20"	3	--	51 Lbs 16.5 Cu Ft	\$ 2,229
	ML-22-FD	Foundation Fabric								\$ 2,229
	ML-22-JY	Journey Fabric								\$ 2,387
	ML-22-TN	Turner Vinyl								\$ 2,559
	ML-23-CB	71" Width Cornerblock Fabric		70 ³ / ₄ "	30 ¹ / ₄ "	20"	4	--	63.5 Lbs 24.8 Cu Ft	\$ 2,796
	ML-23-FD	Foundation Fabric								\$ 2,796
	ML-23-JY	Journey Fabric								\$ 3,004
	ML-23-TN	Turner Vinyl								\$ 3,213
	RECTANGLE, 2 SEMI-CIRCLE ENDS;									
	ML-32-CB	48" Width Cornerblock Fabric		47 ¹ / ₄ "	30 ¹ / ₄ "	20"	3	--	51 Lbs 16.5Cu Ft	\$ 2,373
	ML-32-FD	Foundation Fabric								\$ 2,373
	ML-32-JY	Journey Fabric								\$ 2,553
ML-32-TN	Turner Vinyl									\$ 2,724
	ML-33-CB	71" Width Cornerblock Fabric		70 ³ / ₄ "	30 ¹ / ₄ "	20"	4	--	63.5 Lbs 24.8 Cu Ft	\$ 2,983
	ML-33-FD	Foundation Fabric								\$ 2,983
	ML-33-JY	Journey Fabric								\$ 3,171
	ML-33-TN	Turner Vinyl								\$ 3,356

The Molecule Series is available in a selection of 12 Cornerblock Fabrics; 18 Foundation Fabrics; 20 Journey Fabrics or 26 Turner Vinyls.

For the complete line of Cornerblock Fabrics available, refer to page 6 in this specification guide.

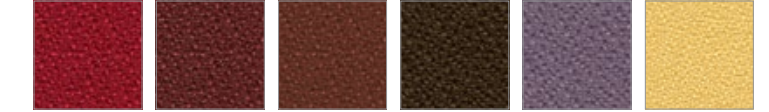

For the complete line of Foundation Fabrics available, refer to page 6 in this specification guide.

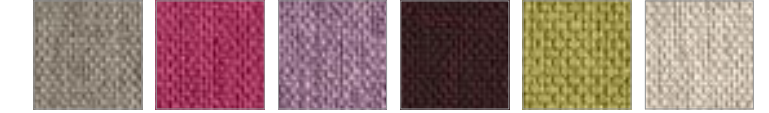



For the complete line of Journey Fabrics available, refer to page 8 in this specification guide.





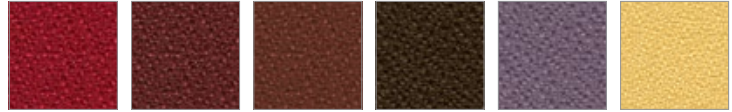
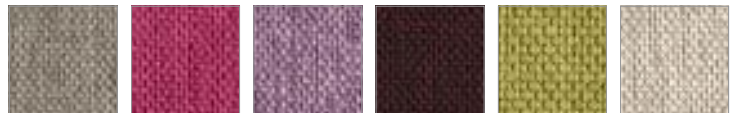

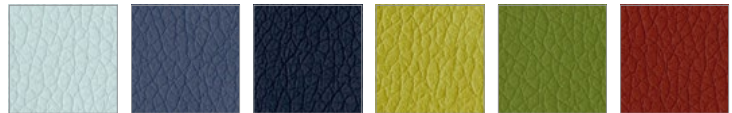
For the complete line of Turner Vinyls available, refer to page 8 in this specification guide.





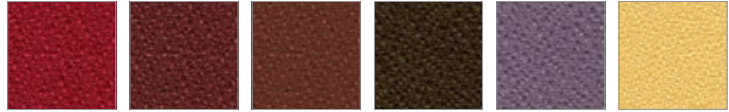
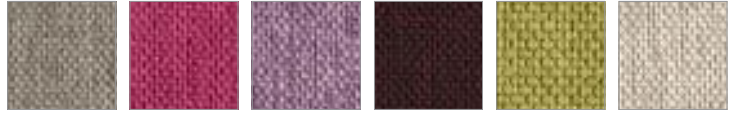

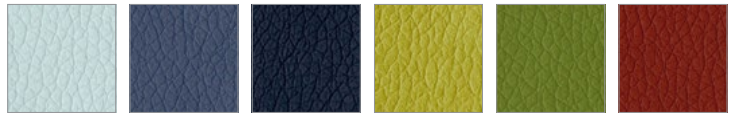





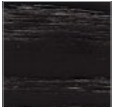

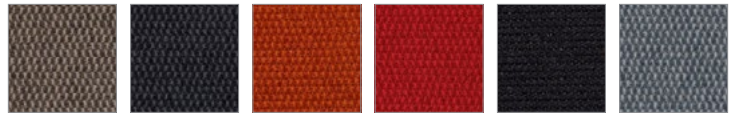
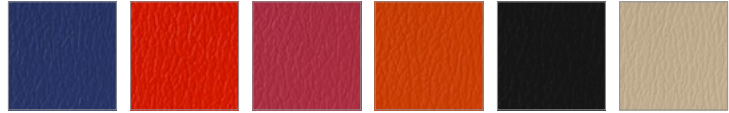







MODEL NUMBER	NAME	SEAT HEIGHT	ARM HEIGHT	WIDTH	DEPTH	HEIGHT	FABRIC YARDS	LEATHER SQ FT	WEIGHT/VOLUME	LIST PRICE	DESCRIPTION
	RECTANGLE, 1 SEMI-CIRCLE END, 1 ROUND END;										The Molecule series is available in a selection of 12 Cornerblock Fabrics; 18 Foundation Fabrics; 20 Journey Fabrics or 26 Turner Vinyls.
	24" Width			23 ⁵ / ₈ "	30 ¹ / ₄ "	20"	3.2	--	53.5 Lbs 11 Cu Ft	\$ 2,143	For the complete line of Cornerblock Fabrics available, refer to page 6 in this specification guide.
	ML-41-CB ML-41-FD ML-41-JY ML-41-TN	Cornerblock Fabric Foundation Fabric Journey Fabric Turner Vinyl								\$ 2,143 \$ 2,272 \$ 2,401	
	48" Width			47 ¹ / ₄ "	30 ¹ / ₄ "	20"	4	--	67 Lbs 19 Cu Ft	\$ 2,775	For the complete line of Foundation Fabrics available, refer to page 6 in this specification guide.
	ML-42-CB ML-42-FD ML-42-JY ML-42-TN	Cornerblock Fabric Foundation Fabric Journey Fabric Turner Vinyl								\$ 2,775 \$ 2,976 \$ 3,178	
	71" Width			70 ³ / ₄ "	30 ¹ / ₄ "	20"	5.3	--	88 Lbs 27 Cu Ft	\$ 3,421	For the complete line of Journey Fabrics available, refer to page 8 in this specification guide.
	ML-43-CB ML-43-FD ML-43-JY ML-43-TN	Cornerblock Fabric Foundation Fabric Journey Fabric Turner Vinyl								\$ 3,421 \$ 3,665 \$ 3,918	
	CIRCLE			26" Dia		21 ⁵ / ₈ "	1.7	--	27.5 Lbs 8.5 Cu Ft	\$ 993	For the complete line of Turner Vinyls available, refer to page 8 in this specification guide.
	ML-5-CB ML-5-FD ML-5-JY ML-5-TN	Cornerblock Fabric Foundation Fabric Journey Fabric Turner Vinyl								\$ 993 \$ 1,058 \$ 1,136	
	CIRCLE, WHITE LAMINATE TOP ONLY			26" Dia		21 ⁵ / ₈ "	1.7	--	27.5 Lbs 8.5 Cu Ft	\$ 2,206	The standard 26" Circle model is entirely covered in fabric, just like models ML-1 to ML-4.
	ML-6-CB-LT ML-6-FD-LT ML-6-JY-LT ML-6-TN-LT	Cornerblock Fabric Foundation Fabric Journey Fabric Turner Vinyl								\$ 2,206 \$ 2,278 \$ 2,358	
	CIRCLE, WHITE LAMINATE TOP, POWER SPHERE WITH 4 OUTLETS;			26" Dia		21 ⁵ / ₈ "	1.7	--	27.5 Lbs 8.5 Cu Ft	\$ 2,603	The 26" Circle with a White Laminate Top and White Acrylic Edge. All other colors of laminate for this particular product are considered an upcharge.
ML-6-CB-LT-P-PS-T	Cornerblock Fabric								\$ 2,603		
ML-6-FD-LT-P-PS-T	Foundation Fabric								\$ 2,682	The 26" Circle with a White Laminate Top, White Acrylic Edge, and Translucent Power Sphere with 4 Electrical Outlets. All other colors of laminate for this particular product are considered an upcharge.	
ML-6-JY-LT-P-PS-T	Journey Fabric								\$ 2,753		
ML-6-TN-LT-P-PS-T	Turner Vinyl										

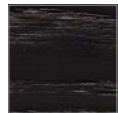

SEATING

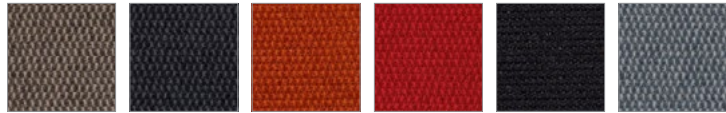
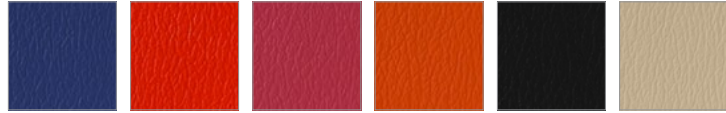



	MODEL NUMBER	NAME	SEAT HEIGHT	ARM HEIGHT	WIDTH	DEPTH	HEIGHT	FABRIC YARDS	LEATHER SQ FT	WEIGHT/VOLUME	LIST PRICE	DESCRIPTION
	PE-1-CB	Penny 1 Seater Cornerblock Fabric	16 ³ / ₄ "		17 ³ / ₈ "	17 ³ / ₈ "	16 ³ / ₄ "	0.93	--	8.82 Lbs 2.9 Cu Ft	\$ 454	<p>The Penny Series is available in a selection of 12 Cornerblock Fabrics; 18 Foundation Fabrics; 20 Journey Fabrics or 26 Turner Vinyls.</p> <p>For the complete line of Cornerblock Fabrics available, refer to page 6 in this specification guide.</p>  <p>For the complete line of Foundation Fabrics available, refer to page 6 in this specification guide.</p>  <p>For the complete line of Journey Fabrics available, refer to page 8 in this specification guide.</p>  <p>For the complete line of Turner Vinyls available, refer to page 8 in this specification guide.</p> 
	PE-1-FD	Foundation Fabric									\$ 454	
	PE-1-JY	Journey Fabric									\$ 538	
	PE-1-TN	Turner Vinyl									\$ 645	
	PE-2-CB	Penny 2 Seater Cornerblock Fabric	16 ³ / ₄ "		34 ⁵ / ₈ "	17 ³ / ₈ "	16 ³ / ₄ "	1.48	--	17.64 Lbs 5.8 Cu Ft	\$ 653	
	PE-2-FD	Foundation Fabric									\$ 653	
	PE-2-JY	Journey Fabric									\$ 745	
	PE-2-TN	Turner Vinyl									\$ 860	

	MODEL NUMBER	NAME	SEAT HEIGHT	ARM HEIGHT	WIDTH	DEPTH	HEIGHT	FABRIC YARDS	LEATHER SQ FT	WEIGHT/VOLUME	LIST PRICE	DESCRIPTION
	PO-1-SI PO-1-ME PO-1-SM	Pods 1 Seater Siena Fabric Messenger Fabric Spirit Milm. Vinyl	17"		25 1/2"	25 1/2"	35 1/2"	3.5	--	50 Lbs 13.4 Cu Ft	\$ 2,125 \$ 2,519 \$ 2,375	<p>The Pods by Dre Series is available in a selection of 16 Siena Fabrics; 15 Messenger Fabrics; or 16 Spirit Millennium Vinyls.</p> <p>Pod 1 Seater - (1) electrical unit Pod 2 Seater - (2) electrical units Pod 3 Seater - (2) electrical units Pods SF Single Bench - (1) electrical unit Pods SF Double Bench - (2) electrical units Pods SF Triple Bench - (2) electrical units Pods SF Combination Bench - (2) electrical units</p> <p>List price includes upholstery and electrical unit(s).</p> <p>Each electrical unit consists of (1) outlet and (2) USB ports located on the side(s).</p> <p>Legs are 1 1/2" high x 3 3/4" diameter solid wood with a plastic glide, in a selection of the following finishes:</p> <p>1) Maple  2) Walnut  3) Black </p> <p>For the complete line of Siena Fabrics available, refer to page 10 in this specification guide.</p>  <p>For the complete line of Messenger Fabrics available, refer to page 10 in this specification guide.</p>  <p>For the complete line of Spirit Millennium Vinyls available, refer to page 12 in this specification guide.</p> 
	PO-2-SI PO-2-ME PO-2-SM	Pods 2 Seater Siena Fabric Messenger Fabric Spirit Milm. Vinyl	17"		51"	25 1/2"	35 1/2"	7	--	100 Lbs 26.7 Cu Ft	\$ 3,731 \$ 4,513 \$ 4,163	
	PO-3-SI PO-3-ME PO-3-SM	Pods 3 Seater Siena Fabric Messenger Fabric Spirit Milm. Vinyl	17"		76 1/2"	25 1/2"	35 1/2"	10	--	150 Lbs 40 Cu Ft	\$ 4,350 \$ 5,463 \$ 4,938	
	PO-11-SI PO-11-ME PO-11-SM	Pods Single Face, Single Bench Siena Fabric Messenger Fabric Spirit Milm. Vinyl	17"		25 1/2"	25 1/2"	17"	2	--	33.3 Lbs 6.4 Cu Ft	\$ 1,825 \$ 2,050 \$ 2,000	
	PO-12-SI PO-12-ME PO-12-SM	Pods Single Face, Double Bench Siena Fabric Messenger Fabric Spirit Milm. Vinyl	17"		51"	25 1/2"	17"	4	--	66.6 Lbs 12.8 Cu Ft	\$ 2,775 \$ 3,038 \$ 2,875	
	PO-13-SI PO-13-ME PO-13-SM	Pods Single Face Triple Bench Siena Fabric Messenger Fabric Spirit Milm. Vinyl	17"		76 1/2"	25 1/2"	17"	6	--	100 Lbs 19.2 Cu Ft	\$ 3,256 \$ 3,925 \$ 3,638	
	PO-14-SI PO-14-ME PO-14-SM	Pods Single Face Combination Bench Siena Fabric Messenger Fabric Spirit Milm. Vinyl	17"		51"	25 1/2"	35 1/2"	5.5	--	75 Lbs 26.7 Cu Ft	\$ 2,963 \$ 3,575 \$ 3,319	



	MODEL NUMBER	NAME	SEAT HEIGHT	ARM HEIGHT	WIDTH	DEPTH	HEIGHT	FABRIC YARDS	LEATHER SQ FT	WEIGHT/ VOLUME	LIST PRICE	DESCRIPTION
	PO-21-SI PO-21-ME PO-21-SM	Pods Double Face, Single Bench Siena Fabric Messenger Fabric Spirit Milm. Vinyl	17"		25 1/2"	48"	26"	6	--	50 Lbs 18.4 Cu Ft	\$ 3,413 \$ 4,081 \$ 3,794	<p>The Pods by Dre Series is available in a selection of 16 Siena Fabrics; 15 Messenger Fabrics; or 16 Spirit Millennium Vinyls.</p> <p>Pods DF Single Bench - (1) electrical unit Pods DF Double Bench - (2) electrical units Pods Short Corner - (1) electrical unit Pods Long Corner - (2) electrical units Pods Cube - N/A</p> <p>List price includes upholstery and electrical unit(s), with the exception of the Pods Cube (PO-40 line) - price includes upholstery only.</p> <p>Each electrical unit consists of (1) outlet and (2) USB ports located on the side(s).</p> <p>Legs are 1 1/2" high x 3 3/4" diameter solid wood with a plastic glide, in a selection of the following finishes:</p> <p>1) Maple   </p> <p>2) Walnut 3) Black</p> <p>For the complete line of Siena Fabrics available, refer to page 10 in this specification guide.</p>  <p>For the complete line of Messenger Fabrics available, refer to page 10 in this specification guide.</p>  <p>For the complete line of Spirit Millennium Vinyls available, refer to page 12 in this specification guide.</p> 
	PO-22-SI PO-22-ME PO-22-SM	Pods Double Face, Double Bench Siena Fabric Messenger Fabric Spirit Milm. Vinyl	17"		51"	48"	26"	12	--	100 Lbs 36.8 Cu Ft	\$ 4,669 \$ 6,006 \$ 5,363	
	PO-31-SI PO-31-ME PO-31-SM	Pods Short Corner Siena Fabric Messenger Fabric Spirit Milm. Vinyl	17"		36"	36"	17"	3.5	--	47 Lbs 12.8 Cu Ft	\$ 2,575 \$ 2,969 \$ 2,825	
	PO-32-SI PO-32-ME PO-32-SM	Pods Long Corner Siena Fabric Messenger Fabric Spirit Milm. Vinyl	17"		50"	50"	17"	7	--	65 Lbs 24.6 Cu Ft	\$ 3,481 \$ 4,263 \$ 3,913	
	PO-40-SI PO-40-ME PO-40-SM	Pods Cube Siena Fabric Messenger Fabric Spirit Milm. Vinyl	17"		20"	20"	17"	2	--	26 Lbs 3.9 Cu Ft	\$ 856 \$ 1,081 \$ 1,031	

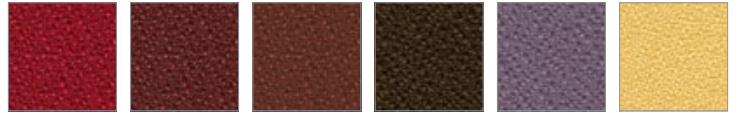

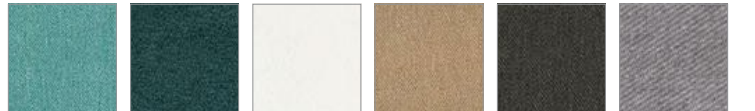



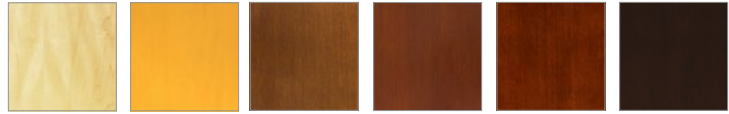

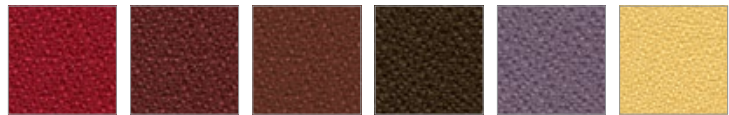
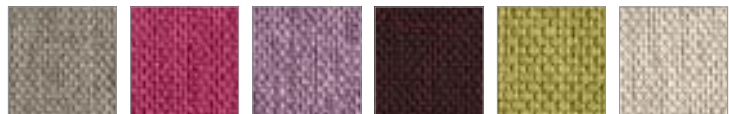
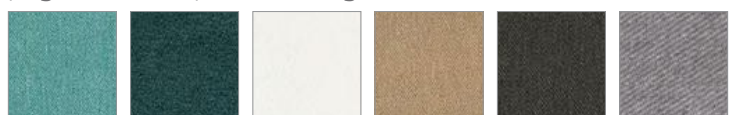

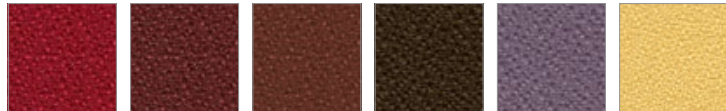
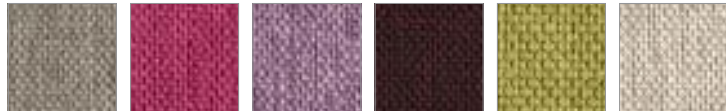

MODEL NUMBER	NAME	SEAT HEIGHT	ARM HEIGHT	WIDTH	DEPTH	HEIGHT	FABRIC YARDS	LEATHER SQ FT	WEIGHT/ VOLUME	LIST PRICE	DESCRIPTION
AB-1-M AB-1-O	Ambassador Chair Maple Oak	18"		20"	24"	36"			25 Lbs 10 Cu Ft	\$ 619 \$ 569	<p>The Ambassador Chair is constructed of 1 1/4" Thick Solid Hardwood Material available in standard Natural Clear Finish. (Minimum order quantity: 25 pcs.)</p> <p>For the complete line of Maple Wood Finishes and options, refer to page 14 in this specification guide.</p> 
AB-2-M AB-2-O	Ambassador Armchair 18" Maple Oak			23 1/2"	24"	36"			27 Lbs 11.8 Cu Ft	\$ 738 \$ 694	<p>For the complete line of Red Oak Wood Finishes and options, refer to page 14 in this specification guide.</p> 
AB-1U-M AB-1U-O	Ambassador Upholstered Chair Maple Oak	18"		20"	24"	36"			25 Lbs 10 Cu Ft	\$ 831 \$ 788	<p>The Upholstered Ambassador chair is 1 1/16" Thick Veneer Core Plywood with a 1 1/2" Thick Firm Grade Foam. Choose from a selection of 12 Cornerblock Fabrics; 18 Foundation Fabrics or 20 Journey Fabrics.</p> <p>For the complete line of Cornerblock Fabrics available, refer to page 6 in this specification guide.</p>  <p>For the complete line of Foundation Fabrics available, refer to page 6 in this specification guide.</p> 
AB-2U-M AB-2U-O	Ambassador Upholstered Armchair Maple Oak	18"		23 1/2"	24"	36"			27 Lbs 11.8 Cu Ft	\$ 881 \$ 831	<p>For the complete line of Journey Fabrics available, refer to page 8 in this specification guide.</p> 







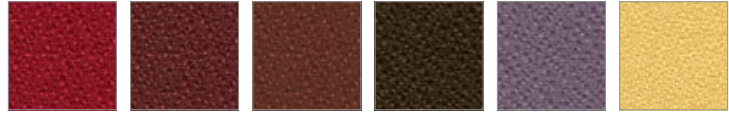
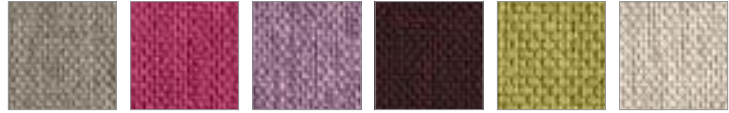





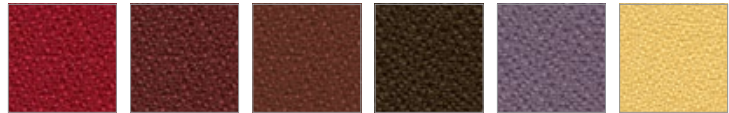

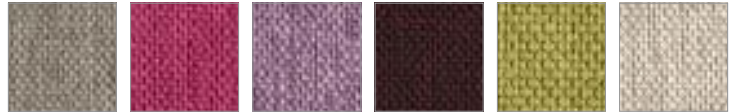

MODEL NUMBER	NAME	SEAT HEIGHT	ARM HEIGHT	WIDTH	DEPTH	HEIGHT	FABRIC YARDS	LEATHER SQ FT	WEIGHT/ VOLUME	LIST PRICE	DESCRIPTION
AP-1-M AP-1-O	Aspen Chair Maple Oak	18"		18 1/2"	22"	33"			25 Lbs 7.8 Cu Ft	\$ 644 \$ 594	<p>The Aspen Chair is constructed of 1" Thick Solid Hardwood Material available in standard Natural Clear Finish. (Minimum order quantity: 25 pcs.)</p> <p>For the complete line of Maple Wood Finishes and options, refer to page 14 in this specification guide.</p> 
AP-2-M AP-2-O	Aspen Armchair Maple Oak	18"		22 1/2"	22"	33"			27 Lbs 9.5 Cu Ft	\$ 738 \$ 694	<p>For the complete line of Red Oak Wood Finishes and options, refer to page 14 in this specification guide.</p> 
AP-1U-M AP-1U-O	Aspen Upholstered Chair Maple Oak	18"		18 1/2"	22"	33"			25 Lbs 7.8 Cu Ft	\$ 669 \$ 619	<p>The Upholstered Aspen chair is 1 1/16" Thick Veneer Core Plywood with a 1 1/2" Thick Firm Grade Foam. Choose from a selection of 12 Cornerblock Fabrics; 18 Foundation Fabrics or 20 Journey Fabrics.</p> <p>For the complete line of Cornerblock Fabrics available, refer to page 6 in this specification guide.</p> 
AP-2U-M AP-2U-O	Aspen Upholstered Armchair Maple Oak	18"		22 1/2"	22"	33"			27 Lbs 9.5 Cu Ft	\$ 713 \$ 669	<p>For the complete line of Foundation Fabrics available, refer to page 6 in this specification guide.</p>  <p>For the complete line of Journey Fabrics available, refer to page 8 in this specification guide.</p> 

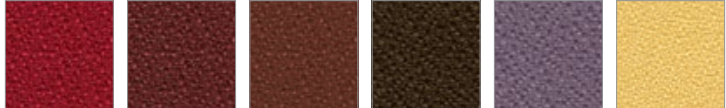

	MODEL NUMBER	NAME	SEAT HEIGHT	ARM HEIGHT	WIDTH	DEPTH	HEIGHT	FABRIC YARDS	LEATHER SQ FT	WEIGHT/VOLUME	LIST PRICE	DESCRIPTION
	BD-1	Bulldog Side Chair	18 ¹ / ₄ "		18"	19"	35"			19 Lbs 6.9 Cu Ft	\$ 500	The Bulldog chair is constructed from 100% Solid European Beech Hardwood available in standard Natural Clear Finish. (Minimum order quantity: 25 pcs.) 
	BD-2	Bulldog Armchair	18"	27"	17 ³ / ₄ "	19 ¹ / ₂ "	35"			21 Lbs 7.0 Cu Ft	\$ 725	The Upholstered Bulldog chair has a 100% Solid European Beech Hardwood Seat; High Density Cushion Foam on Seat; Customer's Own Material Fabric Required for Upholstered Seats. Or choose from a selection of 12 Cornerblock Fabrics; 18 Foundation Fabrics or 20 Journey Fabrics. For the complete line of Cornerblock Fabrics available, refer to page 6 in this specification guide.  For the complete line of Foundation Fabrics available, refer to page 6 in this specification guide.  For the complete line of Journey Fabrics available, refer to page 8 in this specification guide. 
	BD-1U	Bulldog Upholstered Side Chair	18 ¹ / ₄ "		18"	19"	35"	0.35	--	19 Lbs 6.9 Cu Ft	\$ 625	
	BD-2U	Bulldog Upholstered Armchair	18"	27"	17 ³ / ₄ "	19 ¹ / ₂ "	35"	0.35	--	21 Lbs 7.0 Cu Ft	\$ 850	

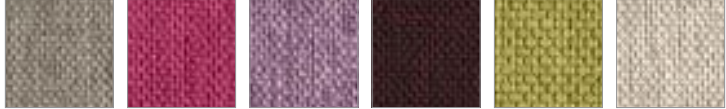



MODEL NUMBER	NAME	SEAT HEIGHT	ARM HEIGHT	WIDTH	DEPTH	HEIGHT	FABRIC YARDS	LEATHER SQ FT	WEIGHT/ VOLUME	LIST PRICE	DESCRIPTION
BD-42-1	Bulldog 42" Bench Without Arms	18"		44 1/2"	18 1/2"	35"			40 Lbs 16.7 Cu Ft	\$ 1,375	The Bulldog bench is constructed from 100% Solid European Beech Hardwood available in standard Natural Clear Finish. (Minimum order quantity: 25 pcs.) 
BD-42-2	Bulldog 42" Bench With Arms	18"	27"	44 1/2"	18 1/2"	35"			42 Lbs 16.7 Cu Ft	\$ 1,481	
BD-60-1	Bulldog 60" Bench Without Arms	18"		59 1/2"	18 1/2"	35"			47 Lbs 22.3 Cu Ft	\$ 1,588	
BD-60-2	Bulldog 60" Bench With Arms	18"	27"	59 1/2"	18 1/2"	35"			49 Lbs 22.3 Cu Ft	\$ 1,694	The Upholstered Bulldog bench has a 100% Solid European Beech Hardwood Seat; High Density Cushion Foam on Seat; Customer's Own Material Fabric Required for Upholstered Seats. Or choose from a selection of 12 Cornerblock Fabrics; 18 Foundation Fabrics or 20 Journey Fabrics. For the complete line of Cornerblock Fabrics available, refer to page 6 in this specification guide. 
BD-42-1U	Bulldog Upholstered 42" Bench Without Arms	18"		44 1/2"	18 1/2"	35"			40 Lbs 16.7 Cu Ft	\$ 1,719	
BD-42-2U	Bulldog Upholstered 42" Bench With Arms	18"	27"	44 1/2"	18 1/2"	35"			42 Lbs 16.7 Cu Ft	\$ 1,825	For the complete line of Foundation Fabrics available, refer to page 6 in this specification guide. 
BD-60-1U	Bulldog Upholstered 60" Bench Without Arms	18"		59 1/2"	18 1/2"	35"			47 Lbs 22.3 Cu Ft	\$ 2,200	For the complete line of Journey Fabrics available, refer to page 8 in this specification guide. 
BD-60-2U	Bulldog Upholstered 60" Bench With Arms	18"	27"	59 1/2"	18 1/2"	35"			49 Lbs 22.3 Cu Ft	\$ 2,306	

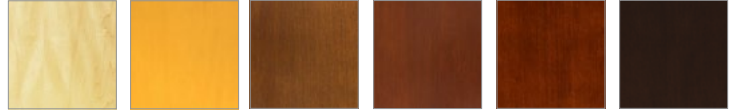





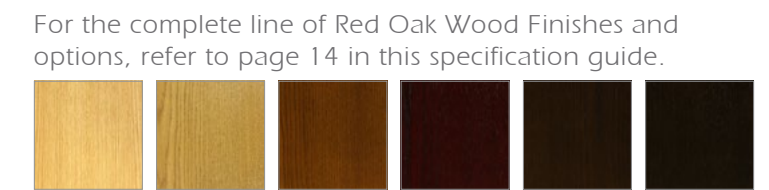
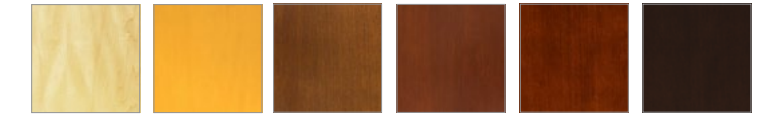

	MODEL NUMBER	NAME	SEAT HEIGHT	ARM HEIGHT	WIDTH	DEPTH	HEIGHT	FABRIC YARDS	LEATHER SQ FT	WEIGHT/ VOLUME	LIST PRICE	DESCRIPTION
	BD-B1	Bulldog Bar Stool	24"		18"	19"	41 1/4"			22 Lbs 8.2 Cu Ft	\$ 550	The Bulldog bar stool is constructed from 100% Solid European Beech Hardwood available in standard Natural Clear Finish. (Minimum order quantity: 25 pcs.) 
	BD-B2	Bulldog Backless Bar Stool	24"		16"	15 3/4"	24"			16 Lbs 3.5 Cu Ft	\$ 419	Bar stools available in custom seat heights ranging from 24" to 30"; Standard kickplates are brass. Chrome kickplates are available upon request for the same price The Upholstered Bulldog bar stool has a 100% Solid European Beech Hardwood Seat; High Density Cushion Foam on Seat; Customer's Own Material Fabric Required for Upholstered Seats. Or choose from a selection of 12 Cornerblock Fabrics; 18 Foundation Fabrics or 20 Journey Fabrics. For the complete line of Cornerblock Fabrics available, refer to page 6 in this specification guide. 
	BD-B1U	Bulldog Upholstered Bar Stool	24"		18"	19"	41 1/4"	0.35	--	22 Lbs 8.2 Cu Ft	\$ 719	For the complete line of Foundation Fabrics available, refer to page 6 in this specification guide. 
	BD-B2U	Bulldog Upholstered Backless Bar Stool	24"		16"	15 3/4"	24"	0.35	-	16 Lbs 3.5 Cu Ft	\$ 594	For the complete line of Journey Fabrics available, refer to page 8 in this specification guide. 



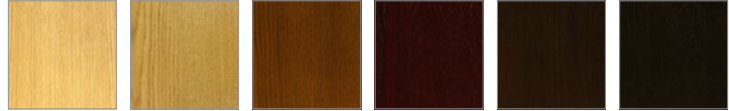



	MODEL NUMBER	NAME	SEAT HEIGHT	ARM HEIGHT	WIDTH	DEPTH	HEIGHT	FABRIC YARDS	LEATHER SQ FT	WEIGHT/ VOLUME	LIST PRICE	DESCRIPTION
	HN-1	Henry Side Chair	18"		18 ¹ / ₄ "	20 ³ / ₄ "	34 ¹ / ₄ "			17 Lbs 7.5 Cu Ft	\$ 563	The Henry series is constructed from 100% Solid European Beech Hardwood. (Minimum order quantity: 25 pcs.) 
	HN-1U	Henry Upholstered Side Chair	18"		18 ¹ / ₄ "	20 ³ / ₄ "	34 ¹ / ₄ "			17 Lbs 7.5 Cu Ft	\$ 688	The Upholstered Henry series has a 100% Solid European Beech Hardwood Seat; High Density Cushion Foam on Seat; Customer's Own Material Fabric Required for Upholstered Seats. Or choose from a selection of 12 Cornerblock Fabrics; 18 Foundation Fabrics or 20 Journey Fabrics. For the complete line of Cornerblock Fabrics available, refer to page 6 in this specification guide. 
	HN-B1	Henry Bar Stool	24"		18 ¹ / ₄ "	19 ¹ / ₄ "	37"			17 Lbs 7.5 Cu Ft	\$ 638	For the complete line of Foundation Fabrics available, refer to page 6 in this specification guide. 
	HN-B1U	Henry Upholstered Bar Stool	30"		18 ¹ / ₄ "	19 ¹ / ₄ "	43"			17 Lbs 8.7 Cu Ft	\$ 763	For the complete line of Journey Fabrics available, refer to page 8 in this specification guide.  Bar stools are available in custom seat heights ranging from 24" to 30"; Standard kickplates are brass. Chrome kickplates are available upon request for the same price. 





MODEL NUMBER	NAME	SEAT HEIGHT	ARM HEIGHT	WIDTH	DEPTH	HEIGHT	FABRIC YARDS	LEATHER SQ FT	WEIGHT/VOLUME	LIST PRICE	DESCRIPTION
HU-1-M HU-1-O	Hudson Chair Maple Oak	18"		21"	20"	38"			18 Lbs 9.2 Cu Ft	\$ 675 \$ 619	<p>The Hudson chair is constructed of Solid Hardwood. (Minimum order quantity: 25 pcs.)</p> <p>For the complete line of Maple Wood Finishes and options, refer to page 14 in this specification guide.</p> 
HU-2-M HU-2-O	Hudson Armchair Maple Oak	18"	25 ⁵ / ₈ "	21"	20"	38"			19 Lbs 9.2 Cu Ft	\$ 775 \$ 713	<p>For the complete line of Red Oak Wood Finishes and options, refer to page 14 in this specification guide.</p> 
HU-1U-M HU-1U-O	Hudson Chair Upholstered Maple Oak	18"		21"	20"	38"			18 Lbs 9.2 Cu Ft	\$ 725 \$ 669	 <p>The Hudson chair is also available with an upholstered seat constructed from High Density Upholstered Cushion Foam. Choose from a selection of 12 Cornerblock Fabrics; 18 Foundation Fabrics or 20 Journey Fabrics.</p> <p>For the complete line of Cornerblock Fabrics available, refer to page 6 in this specification guide.</p> 
HU-2U-M HU-2U-O	Hudson Upholstered Armchair Maple Oak	18"	25 ⁵ / ₈ "	21"	20"	38"			19 Lbs 9.2 Cu Ft	\$ 819 \$ 756	 <p>For the complete line of Foundation Fabrics available, refer to page 6 in this specification guide.</p>  <p>For the complete line of Journey Fabrics available, refer to page 8 in this specification guide.</p> 

	MODEL NUMBER	NAME	SEAT HEIGHT	ARM HEIGHT	WIDTH	DEPTH	HEIGHT	FABRIC YARDS	LEATHER SQ FT	WEIGHT/VOLUME	LIST PRICE	DESCRIPTION
	LD-1-M LD-1-O	Lido Chair Maple Oak	18"		18 1/2"	18"	32"			23 Lbs 6.2 Cu Ft	\$ 506 \$ 456	The Lido chair is constructed of Solid Hardwood Frame with a 3/4" Thick 3-ply Shaped Plywood with Grade "A" Face Veneers on front and back seat.
	LD-1-C-M LD-1-C-O	Lido Youth Chair Maple Oak	16"		18 1/2"	18"	30"			23 Lbs 5.8 Cu Ft	\$ 506 \$ 456	For the complete line of Maple Wood Finishes and options, refer to page 14 in this specification guide.
	LD-1-J-M LD-1-J-O	Lido Juvenile Chair Maple Oak	14"		16"	15 1/2"	26"			20 Lbs 3.7 Cu Ft	\$ 450 \$ 406	
	LD-1-P-M LD-1-P-O	Lido Primary Chair Maple Oak	12"		16"	15 1/2"	24"			20 Lbs 3.4 Cu Ft	\$ 450 \$ 406	
	LD-2-M LD-2-O	Lido Armchair Maple Oak	18"	24 1/2"	23"	18"	32"			27 Lbs 7.7 Cu Ft	\$ 600 \$ 550	
	LD-3-M LD-3-O	Lido Sled Base Chair Maple Oak	18"		18 1/2"	18"	32"			23 Lbs 6.2 Cu Ft	\$ 600 \$ 550	
	LD-32-M LD-32-O	Lido Sled Base Armchair Maple Oak	18"	24 1/2"	23"	18"	32"			27 Lbs 7.7 Cu Ft	\$ 638 \$ 594	

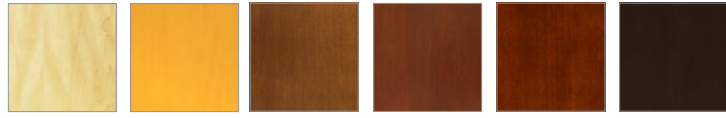

	MODEL NUMBER	NAME	SEAT HEIGHT	ARM HEIGHT	WIDTH	DEPTH	HEIGHT	FABRIC YARDS	LEATHER SQ FT	WEIGHT/ VOLUME	LIST PRICE	DESCRIPTION
	LD-1U-M LD-1U-O	Lido Upholstered Maple Oak	18"		18 1/2"	18"	32"			23 Lbs 6.2 Cu Ft	\$ 669 \$ 619	The Lido Chair is constructed of Solid Hardwood Frame with a 3/4" Thick 3-Ply Shaped Plywood with Grade "A" Face Veneers on front and back seat.
	LD-1U-C-M LD-1U-C-O	Lido Upholstered Youth Chair Maple Oak	16"		18 1/2"	18"	30"			23 Lbs 5.8 Cu Ft	\$ 669 \$ 619	For the complete line of Maple Wood Finishes and options, refer to page 14 in this specification guide. 
	LD-1U-J-M LD-1U-J-O	Lido Upholstered Juvenile Chair Maple Oak	14"		16"	15 1/2"	26"			20 Lbs 3.7 Cu Ft	\$ 619 \$ 575	For the complete line of Red Oak Wood Finishes and options, refer to page 14 in this specification guide. 
	LD-1U-P-M LD-1U-P-O	Lido Upholstered Primary Chair Maple Oak	12"		16"	15 1/2"	24"			20 Lbs 3.4 Cu Ft	\$ 619 \$ 575	The Lido chair is also available with a 3/8" Thick Shaped Plywood with a 1 1/4" Thick Foam Covering Upholstered Seat and Back. Choose from a selection of 12 Corner-block Fabrics; 18 Foundation Fabrics or 20 Journey Fabrics.
	LD-2U-M LD-2U-O	Lido Upholstered Armchair Maple Oak	18"	24 1/2"	23"	18"	32"			27 Lbs 7.7 Cu Ft	\$ 763 \$ 713	For the complete line of Cornerblock Fabrics available, refer to page 6 in this specification guide. 
	LD-3U-M LD-3U-O	Lido Upholstered Sled Base Chair Maple Oak	18"		18 1/2"	18"	32"			23 Lbs 6.2 Cu Ft	\$ 813 \$ 763	For the complete line of Foundation Fabrics available, refer to page 6 in this specification guide. 
	LD-32U-M LD-32U-O	Lido Upholstered Sled Base Chair Armchair Maple Oak	18"	24 1/2"	23"	18"	32"			27 Lbs 7.7 Cu Ft	\$ 856 \$ 813	For the complete line of Journey Fabrics available, refer to page 8 in this specification guide. 

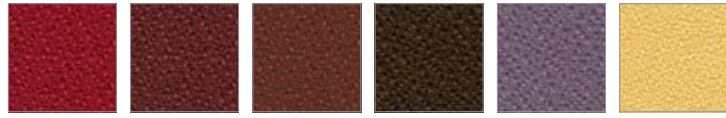
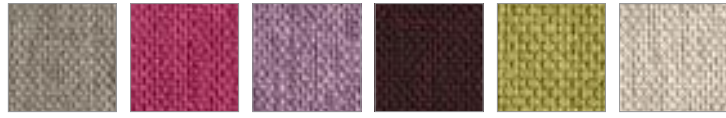
	MODEL NUMBER	NAME	SEAT HEIGHT	ARM HEIGHT	WIDTH	DEPTH	HEIGHT	FABRIC YARDS	LEATHER SQ FT	WEIGHT/ VOLUME	LIST PRICE	DESCRIPTION
	H20-W	Safari Chair - Hank Horse Wood Seat/ Back	14"		15 ³ / ₄ "	26"	28"	-	-	15 Lbs	\$ 2,200	The Safari chair is constructed of 3/4" plywood with laminate 2-faced image.
	H20-U	Upholstered Seat/Back								6.6 Cu Ft	\$ 2,469	
	H20-BW	Bench Wood Seat/Back	14"		38"	26"	28"	-	-	20 Lbs	\$ 2,531	
	H20-BU	Bench Upholstered Seat/Back								16 Cu Ft	\$ 2,800	
	R30-W	Safari Chair - Rex Dinosaur Wood Seat/ Back	14"		15 ³ / ₄ "	24"	26"	-	-	15 Lbs	\$ 2,200	The Safari chair is also available with a 1 1/4" Thick Foam Covering Upholstered Seat and Back. Choose from a selection of 12 Cornerblock Fabrics; 18 Foundation Fabrics; 20 Journey Fabrics or 26 Turner Vinyls.
	R30-U	Upholstered Seat/Back								5.7 Cu Ft	\$ 2,469	
	R30-BW	Bench Wood Seat/Back	14"		38"	24"	26"	-	-	20 Lbs	\$ 2,531	
	R30-BU	Bench Upholstered Seat/Back								13.7 Cu Ft	\$ 2,800	
	E40-W	Safari Chair - Ellie Elephant Wood Seat/ Back	14"		15 ³ / ₄ "	22 ¹ / ₂ "	27"	-	-	15 Lbs	\$ 2,200	For the complete line of Cornerblock Fabrics available, refer to page 6 in this specification guide.
	E40-U	Upholstered Seat/Back								5.5 Cu Ft	\$ 2,469	
	E40-BW	Bench Wood Seat/Back	14"		38"	22 ¹ / ₂ "	27"	-	-	20 Lbs	\$ 2,531	
	E40-BU	Bench Upholstered Seat/Back								13.4 Cu Ft	\$ 2,800	
	D50-W	Safari Chair - Doris Duck Wood Seat/ Back	14"		15 ³ / ₄ "	24 ¹ / ₄ "	27 ¹ / ₄ "	-	-	15 Lbs	\$ 2,200	For the complete line of Foundation Fabrics available, refer to page 6 in this specification guide.
	D50-U	Upholstered Seat/Back								6.0 Cu Ft	\$ 2,469	
	D50-BW	Bench Wood Seat/Back	14"		38"	24 ¹ / ₄ "	27 ¹ / ₄ "	-	-	20 Lbs	\$ 2,531	
	D50-BU	Bench Upholstered Seat/Back								14.5 Cu Ft	\$ 2,800	
	Z60-W	Safari Chair - Zack Zebra Wood Seat/ Back	14"		15 ³ / ₄ "	26"	28"	-	-	15 Lbs	\$ 2,200	For the complete line of Journey Fabrics available, refer to page 8 in this specification guide.
	Z60-U	Upholstered Seat/Back								6.6 Cu Ft	\$ 2,469	
	Z60-BW	Bench Wood Seat/Back	14"		38"	26"	28"	-	-	20 Lbs	\$ 2,531	
	Z60-BU	Bench Upholstered Seat/Back								16 Cu Ft	\$ 2,800	
	W70-W	Safari Chair - Wally Whale Wood Seat/ Back	14"		15 ³ / ₄ "	24"	28"	-	-	15 Lbs	\$ 2,200	For the complete line of Turner Vinyls available, refer to page 8 in this specification guide.
	W70-U	Upholstered Seat/Back								6.1 Cu Ft	\$ 2,469	
	W70-BW	Bench Wood Seat/Back	14"		38"	24"	28"	-	-	20 Lbs	\$ 2,531	
	W70-BU	Bench Upholstered Seat/Back								14.8 Cu Ft	\$ 2,800	
	M80-W	Safari Chair - Moe Monkey Wood Seat/ Back	14"		15 ³ / ₄ "	21 ¹ / ₄ "	26 ³ / ₄ "	-	-	15 Lbs	\$ 2,200	
	M80-U	Upholstered Seat/Back								5.2 Cu Ft	\$ 2,469	
	M80-BW	Bench Wood Seat/Back	14"		38"	21 ¹ / ₄ "	26 ³ / ₄ "	-	-	20 Lbs	\$ 2,531	
	M80-BU	Bench Upholstered Seat/Back								12.5 Cu Ft	\$ 2,800	

	MODEL NUMBER	NAME	SEAT HEIGHT	ARM HEIGHT	WIDTH	DEPTH	HEIGHT	FABRIC YARDS	LEATHER SQ FT	WEIGHT/VOLUME	LIST PRICE	DESCRIPTION
	SS-1-M SS-1-O	Silver Sled Maple Oak	16 ³ / ₄ "		17"	18 ⁵ / ₈ "	32"			17 Lbs 5.9 Cu Ft	\$ 738 \$ 694	<p>The Silver Sled Chair is constructed of Solid Hardwood. (Minimum order quantity: 25 pcs.)</p> <p>For the complete line of Maple Wood Finishes and options, refer to page 14 in this specification guide.</p> 
	SS-1U-M SS-1U-O	Silver Sled Upholstered Maple Oak	18 ¹ / ₄ "		17"	18 ⁵ / ₈ "	32"			17 Lbs 5.9 Cu Ft	\$ 831 \$ 788	<p>For the complete line of Red Oak Wood Finishes and options, refer to page 14 in this specification guide.</p>  <p>The Silver Sled Chair is also available with an upholstered seat constructed from High Density Upholstered Foam Cushion seat. Choose from a selection of 12 Cornerblock Fabrics; 18 Foundation Fabrics; or 20 Journey Fabrics.</p> <p>For the complete line of Cornerblock Fabrics available, refer to page 6 in this specification guide.</p>  <p>For the complete line of Foundation Fabrics available, refer to page 6 in this specification guide.</p>  <p>For the complete line of Journey Fabrics available, refer to page 8 in this specification guide.</p> 
	WO-18-M	18" Wood Stool Maple	18"			13"	18"			15 Lbs 1.8 Cu Ft	\$ 525	<p>The Wood Stool is constructed of Solid Hardwood.</p>
	WO-24-M	24" Wood Stool Maple	24"			13"	24"			17 Lbs 2.3 Cu Ft	\$ 550	
	WO-30-M	30" Wood Stool Maple	30"			13"	30"			20 Lbs 2.9 Cu Ft	\$ 575	

Palmieri Furniture Limited ("Palmieri") warrants that its products and collections are free from defects in materials and workmanship for the life of the product, except as set forth below. Palmieri Limited Lifetime Warranty is valid from the date of delivery.

Exceptions to the Limited Lifetime Warranty: Seating: two (2) years

Goods sold hereunder are covered by a Limited Lifetime Warranty, free against defects in material and workmanship provided the goods and services are subjected to normal use and service. The applicable warranty period commences from shipping date to Purchaser of any item of the goods, whichever occurs first, or any other warranty period otherwise stipulated in writing by Palmieri under this sale. For components not supplied by Palmieri, the original manufacturer's warranty shall apply to the extent assignable by Palmieri. The obligation under this warranty is limited to the repair or replacement, at Palmieri's option, of defective parts F.O.B. point of shipment provided that prompt notice of any defect is given by Purchaser to Palmieri in writing within the applicable warranty period and that upon the Purchaser's return of the defective parts to Palmieri or, if designated by Palmieri, to the location where the works are made, properly packed and with transportation charges prepaid by Purchaser, an inspection thereof shall reveal to Palmieri's satisfaction that Purchaser's claim is valid under the terms of this warranty. Purchaser shall assume all responsibility and expense for dismantling, removal, re-installation and freight in connection with the foregoing. The same obligations and conditions extend to replacement parts furnished by Palmieri hereunder.

Palmieri does not assume liability for installation, labour or consequential damages. Palmieri makes no warranty other than the one set forth herein. All other warranties, legal, expressed or implied, including but not limited to any expressed or implied warranty of merchantability, of fitness for the intended use thereof or against infringement are hereby expressly excluded. The applicable warranty ceases to be effective if the goods are altered or repaired other than by persons authorized or approved by Palmieri to perform such work. Repairs or replacement deliveries do not interrupt or prolong the term of the warranty. The warranty ceases to be effective if Purchaser fails to handle and use the goods sold hereunder in a safe and reasonable manner and in accordance with any written instructions from the manufacturers.

Warranty Does Not Apply To Product Failure Or Loss Resulting From:

Abuse, misuse or accident, alteration or modification of product by customer or third party, normal wear and tear, improper installation, handling or incorrect use. The substitution of part components or hardware not approved or authorized by Palmieri, acts of God, unauthorized repairs, improper storage, and environmental conditions such as irregular temperature control either inside or outside the environment.

Warranty Provides Exclusive Remedies:

If a product fails under ordinary use as a result of a defect in material or workmanship, Palmieri will: (A) repair, or (B) replace the furniture. The replacement or repair of the Furniture or Seating will be at the discretion of Palmieri. If the defect or workmanship cannot be remedied on site, repairs can be made at the factory. (C) If the product repair or replacement is not commercially practicable or cannot be remade in a timely manner Palmieri will refund the purchase price of the affected product. A product "**Defect**" means: an inadequacy in the materials or workmanship of the product that (A) existed at the time when you received the product from Palmieri or Palmieri authorized Reseller and (B) causes a failure of the product to perform under ordinary use in accordance with the materials and documentation accompanying the product. "**Ordinary Use**" means: use of the product (A) in accordance with all applicable local, state or federal laws, codes and regulations and (B) in accordance with manufacturer recommendations and or instructions in the materials and documentation accompanying the product or through shop drawings. A "**Palmieri Authorized Reseller**" means: any dealer that is legally permitted to conduct business in the jurisdiction where the product is sold and is duly authorized by Palmieri to sell the product.

Warranty work must be approved by authorized personnel of Palmieri Furniture Limited in Richmond Hill, Ontario, Canada.

A copy of the original purchase order must accompany all claims.

Warranty Does Not Cover:

Matching of colours, stains, textures, grains and any other variations in materials. Select and Custom Surfaces and materials are only warranted for their application on the specified product and are not covered by our warranty, except as warranted by the original supplier, for quality, colorfastness, shade variations or abrasion and textiles purchased for Palmieri product.

This limited warranty is the sole remedy for product defect and no other express or implied warranty is provided. Warranty is not transferable and valid only for the original purchaser acquiring a product from Palmieri or a Palmieri authorized reseller for the purchaser's own use and not for resale, remarketing or distribution. Limited Lifetime Warranty (25 years)

GENERAL

The following Terms and Conditions of Quote and Sale shall apply to any sale of goods and services by Palmieri Furniture Limited (hereinafter called "Palmieri"). Purchaser shall be deemed to have full knowledge of the terms and conditions herein and such terms and conditions shall be binding if either the goods and services referred to herein are delivered to and accepted by Purchaser, or if Purchaser does not within five (5) days from the date hereof deliver to Palmieri written objection to said terms and conditions or any part thereof.

In the event of any conflict or inconsistency between the terms and conditions of sale herein and the terms and conditions contained in Purchaser's order or in any other form issued by Purchaser, whether or not any such form has been acknowledged or accepted by Palmieri, Palmieri's terms and conditions herein shall prevail. No waiver, alteration or modification of these terms and conditions shall be binding upon Palmieri unless made in writing and signed by a duly authorized representative of Palmieri.

1. QUOTATIONS / PRODUCT QUOTED

Unless otherwise stated, **Palmieri's quotations shall be null and void unless accepted by Purchaser within thirty (30) days from the date of quotation.** Quotes may be subject to change before order placement, due to increased material costs and or other factors that could impact the final cost of production and our final understanding of the product required. If the items quoted do not reflect the intended product requirements of the customer, Palmieri will not be held responsible for increased costs for those product changes. We reserve the right to edit or re-quote any portion of a previously submitted quotation subject to our final understanding of the product required by the client.

2. PALMIERI DRAWINGS

Palmieri provides drawings for Custom & Standard product we produce to our clients upon request. We consider these drawings to be Private and Confidential and are provided for the sole purpose and use of our clients to understand the product we are providing. The use of these confidential materials is limited to the transaction between the parties and at no point are these confidential materials to be sent to any of our competitors or parties quoting for the same purpose.

A minimum \$85.00 NET Engineering Administrative Fee will apply for Custom Product Drawings

(Note: The first set of Custom product drawings will be free of charge)

A minimum \$120.00 NET Engineering Administrative Fee will apply for all Standard Product Drawings

3. TERMS OF PAYMENT

For authorized customers; Orders at a \$75,000.00 threshold will require a mandatory 25% deposit. Orders over and above \$100,000.00 requires a mandatory (25%) deposit at time of order, a mandatory (25%) deposit prior to product shipment and the balance to be paid within thirty (30) days of date of shipment. Payment not be made to Palmieri when due, Palmieri reserves the right to charge Purchaser with interest on such overdue payments. Interest of 2% per month (24% per annum) is charged on all overdue accounts, unless otherwise specified. The charging of such interest shall not be construed as obligating Palmieri to grant any extension of time in the terms of payment. All goods remain the property of Palmieri, until balance is paid in full to Palmieri.

4. TITLE

Title to the goods or any part thereof shall not pass from Palmieri to Purchaser until all payments due hereunder have been duly made, except as otherwise expressly stipulated herein. The goods shall be and remain personal or moveable property, notwithstanding their mode of attachment to realty or other property. If default is made in any of the payments herein, Purchaser agrees that Palmieri may retain all payments which have been made on account of the purchase price as liquidated damages, and Palmieri shall be free to enter the premises where the goods may be located and remove them as Palmieri's property, without prejudice to Palmieri's right to recover any further expenses or damages Palmieri may suffer by reason of such nonpayment.

5. TAXES

Prices do not include Goods & Services Tax, Provincial or Municipal sales, use, value-added or similar tax. All applicable taxes are extra. Our Harmonized Sales Tax (HST) registration number is R104055066.

6. THE AGREEMENT

An acceptance and official confirmation of Purchasers' order by signing Palmieri's Order Confirmation the Purchaser therefore is accepting terms and conditions as expressed herein Palmieri's Terms and Conditions of Quote and Sale by Palmieri and shall constitute the complete agreement, subject to the terms and conditions of sale herein set forth, and shall supersede all previous quotations, orders or agreements.

7. LEAD TIME / DELIVERY / DELAYS

Lead time is determined only when final material/finish selection and drawing approvals are received by Palmieri from the client. The accuracy of Palmieri's lead times, is created to the best of our ability with the information provided to us. Confirmed lead time is conveyed to the client by means of Order Confirmation. They do not preclude the client from checking the accuracy of your requirement and our Order Confirmation. Any noted discrepancies are to be reported immediately to Palmieri Customer Service Department for correction and re-issue of revised Order Confirmation. By signing and dating the Order Confirmation the client accepts the terms and conditions of quote and sale.

Lead time on our Order Confirmation do not account for delays that could potentially occur for special materials specified by the client that are outside of our standard finishes and materials program that are out of our control

and will affect the lead time on the order. Palmieri will notify the client immediately when these delays occur and adjust the lead time accordingly.

Delivery schedules are approximate and are based on prevailing market conditions applicable respectively at the time of Palmieri's quotation and Palmieri's acceptance of clients' order, if certain portions of an order are completed by the quoted lead time while other portions have experienced delays outside of our control. The client may choose to part ship the order at their discretion and expense. Otherwise the entire order will ship with the delayed portion at a later date. Palmieri may extend delivery schedules or may, at its option, cancel Purchaser's order in full or in part without liability other than to return any deposit or prepayment which is unearned by reason of the cancellation.

8. CHANGES AND CANCELLATION

Orders accepted by Palmieri are not subject to changes or cancellation by Purchaser without the written consent of Palmieri. In such cases where Palmieri authorizes changes or cancellation, Palmieri reserves the right to charge the Purchaser with reasonable costs based upon expenses already incurred and commitments made by Palmieri, including, without limitation, any labour done, material purchased and also including Supplier's usual overhead and reasonable profit and cancellation charges from Palmieri's suppliers. Palmieri will communicate to the Purchaser additional costs incurred by way of Revised Order Confirmation. Revised Order Confirmation will include applicable costs incurred and modification to lead times (if applicable). The Purchaser must provide Palmieri written confirmation of additional costs, before any changes can be processed on the order.

A minimum charge of \$100.00 NET Change Order Request fee will apply

A minimum charge of \$150.00 NET Cancel Order Request fee will apply.

9. SHIPPING LOCATION / SHIPPING QUOTES / COST OF TRANSPORTATION

Unless otherwise stated, all prices are F.O.B. our factory in Richmond Hill, Ontario, Canada.

Customary methods of transportation shall be selected by Palmieri and such transportation will be at Purchaser's expense. Shipping quotations are made at time of furniture quotation and are outside the control of Palmieri. **Shipping quotes are valid for ten (10) business days from the time of quote.** We do our best to maintain shipping costs as quoted, however all shipping weights and cubic feet shown are approximate only, various construction materials and packaging methods may add to the weights given. All quoted prices, unless otherwise stated on the quotation, are based on the current exchange rates, tariffs, fuel surcharges and costs of manufacture and are subject to change by Palmieri with or without notice until Purchaser's acceptance. Palmieri does not assume responsibility or liability for shipping costs, product during transit, or variances from the shipping weights or cubic feet shown in our specification guides. Special methods of transportation will be used upon Purchaser's request and at Purchaser's additional expense, provided reasonable notice of Purchaser's transportation requirements are given by Purchaser to Palmieri prior to shipment. Palmieri will notify the client prior to shipping product if shipping costs as quoted change, at which point the client must approve the adjusted shipping costs.

10. RECEIVING PRODUCT / REPORTING DAMAGE / STORAGE OF PRODUCT

Upon receipt of Palmieri product, the receiver of the goods must immediately inspect the product to ensure it is free of shipping damage. If the product is deemed in good order, the receiver of the product must ensure

to sign off on the accompanying carriers Bill of lading in good condition. Except for obligations stated under "Warranty" herein, Palmieri's responsibility for the product ceases once the product has been received and signed off in good order and is the full responsibility of the receiver and subsequently the owner.

In the event shipping damage is discovered during receipt of shipment, it is the responsibility of the receiver to ensure all noted damage is recorded on the carrier's Bill of Lading prior to sign off. All noted shipping damage claims must be reported to Palmieri within **24 hours** of receipt of the product onsite, failure to do so will result in the claim being deemed null and void. All shipping damage claims are to be reported directly to Palmieri's Shipping Manager. Please call our toll free number at **1-800-413-4440 ext. 33** or submit the claim by Fax directly to **1-905-731-9878**. Palmieri will not accept any shipping damage claims submitted **after 24 hours** and it shall be conclusively presumed that the goods were delivered in good condition.

Storage of product, Palmieri will not be held responsible for any potential damages or shortages for product shipped and received by Purchaser and is subsequently placed into storage and not inspected within 24 hours of receipt.

11. INSTALLATION / SHORTAGES / BACK CHARGES

Unless otherwise expressly stipulated, the goods shall be installed by and at the risk and expense of Purchaser.

In the event that Palmieri is requested to supervise such installation, Palmieri's responsibility shall be limited to exercising that degree of skill customary in the trade in supervising installations of the same type. Purchaser shall remain responsible for all other aspects of the work including compliance with the local regulations. It is the responsibility of the Purchaser to ensure hardware and parts are received in good order. Packing slip and hardware list to be provided by Palmieri with every order at time of shipping. Purchaser has the responsibility to notify Palmieri immediately without delay of issues that arise; subsequently Palmieri will take action to provide prompt resolution.

Shortages must be reported to Palmieri within **24 hours** of receipt of the goods and failure to do so may be at the expense of the Purchaser.

If deemed missing hardware and parts short shipped from the factory, Palmieri will arrange to ship freight prepaid to destination. Palmieri will only be responsible for replacement costs of missing hardware and parts, any labour costs incurred will be the responsibility of the Purchaser and will not be approved by Palmieri.

Back Charges will only be approved if we deemed a defect in the material or workmanship is found during the installation period resulting in a return trip to the job-site to complete installation. It shall remain the sole discretion of Palmieri to approve (A) repair or (B) replace the furniture and any labour costs incurred by the Purchaser.

12. FORCE MAJEURE

Palmieri shall not be responsible or liable for any loss or damage incurred by Purchaser herein resulting from causes beyond the reasonable control of Palmieri including, but without limitation, abuse, misuse or accident, alteration or modification of product by customer or third party, normal wear and tear, improper installation, handling or incorrect use, unauthorized repairs, the substitution of part components or hardware not approved or authorized by Palmieri, improper storage, and environmental conditions such as irregular temperature control

either inside or outside the environment, acts of God, fire, flood, delays in transportation, or the failure of Palmieri's suppliers to meet their delivery promises. The acceptance of delivery of the goods by Purchaser shall constitute a waiver of all claims for loss or damage due to any delay whatsoever.

13. RETURNED GOODS

No goods may be returned to Palmieri for a credit or exchanged without Palmieri's prior written consent.

Palmieri reserves the right to accept all returns and subject to a handling/restocking charge or to decline all returns. Even after Palmieri has authorized the return of goods for credit, Palmieri reserves the right to adjust the amount of any credit given to Purchaser on return of the goods based on the conditions of the goods on arrival in Palmieri's warehouse. Credit for returned goods will be issued to Purchaser only where such goods are returned by Purchaser and not by any subsequent owner of the goods. Goods will be considered for return only if they are in their original condition and packaging. Palmieri Goods Return Authorization Form to be issued and **must** accompany all shipments returning back to the factory. **Return freight must be prepaid by Purchaser. A minimum 20% re-stocking fee will apply.**

1230 Reid Street | T 905 731 9300
Richmond Hill F 905 731 9878
Ontario Canada TF 800 413 4440
L4B 1C4 info@palmierifurniture.com
www.PalmieriFurniture.com

SPECIFICATION GUIDE

2017

PALMIERI

FABRIC FINISHES

CATEGORY: LIBRARY FURNITURE
CONTRACT: BID #ESCNJ 17/18-16

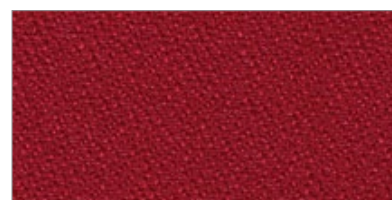

Red 14

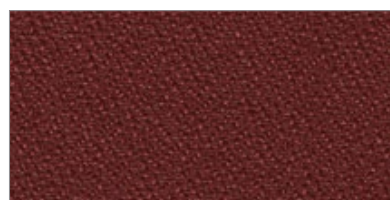

Burgundy 108

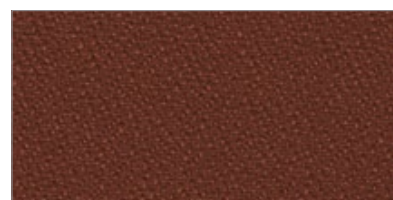

Terracotta 405



Gold 59

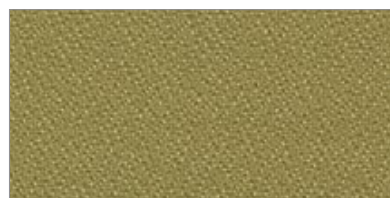

Eucalyptus 64

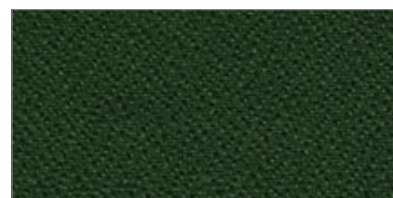

Green 208



Purple 1009



Mist 32



Navy 308

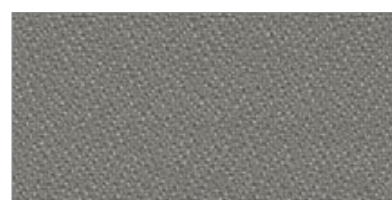

Charcoal 908



Black 9009

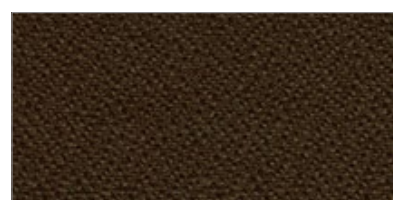

Brown 87

CORNERBLOCK FABRIC SPECIFICATION:

Abrasion: Exceeds 420,000 Double Rubs.

Backing Content: 100% Acrylic

Cleaning Instruction: S - Solvent Cleaner.

Colors Available: 12 colors available.

Construction: Crepe

Content: 100% Polyester

Crocking: AATCC 8: Dry = Class 4.5 AATCC 8: Wet = Class 4.5

Description: Solid Crepe: Contract Rated

Fire Retardancy: California Bulletin 117-Section E, Motor Vehicle Safety Standard 302. NFPA 260 Class 1. UFAC Class 1

Pilling: Passes ASTM D3511: Class 4.5

Protective Finish: Stain and Soil Resistant Finish

Railroaded Pattern: Non-Directional

Seam Slippage: Passes Seam Slippage ASTM D4034: W 61 x F 66 LBF

Tear Strength: Passes ASTM D2261: Warp = 54 lbs and Fill = 72 lbs.

Tensile Strength: Passes ASTM D5034: Warp = 491 lbs and Fill = 364 lbs.

Ultraviolet: LIGHTFASTNESS IS 40 HOURS Colorfastness to Light AATCC16 Class 4.5

Weight: 11.06 ounces per square yard. 17.51 Ounces per Linear Yard

*To request large individual Sample Colors please visit: www.jennisfabrics.com



Fawn 67



Radiant Orchid 102



Lilac 105



Rosewood 108



Linen 608



Beaver 808

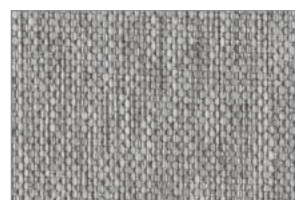

Wind Chime 905



Mud 908



Denim 3006



Zantium 3009

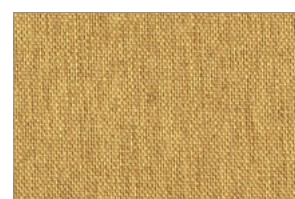

Old Gold 4009



Buff 6009



Coffee 8009



Steel 9003



Licorice 9009



Hemlock 202



Air 3003



Saddlewood 8006

FOUNDATION FABRIC SPECIFICATION:

Abrasion: Exceeds 100,000 Double Rubs.

Backing Content: 100% Polyester

Cleaning Instruction: WC - Wash with care.

Colors Available: 18 colors available.

Content: 100% Polyester

Crocking: AATCC 8: Dry 4.5, Wet 4.5

Fire Retardancy: California (CAL) Bulletin 117-Section E, UFAC Class 1t

Pilling: ASTM D3511: Class 4.5

Seam Slippage: ASTM D4034: Warp = 64 lbs. and Fill = 70 lbs.

Tear Strength: ASTM D2261: Warp = 36 lbs. and Fill = 24 lbs.

Tensile Strength: ASTM D5034: Warp = 335 lbs and Fill = 168 lbs.

Ultraviolet: Colorfastness to Light AATCC16 Class 3

Weight: 11.21 ounces per square yard. 17.75 ounces per linear yard.

*To request large individual Sample Colors please visit: www.jennisfabrics.com

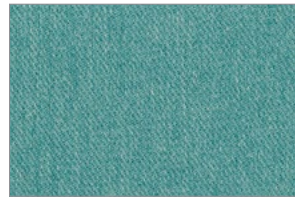

Seabreeze 34



Gunmetal 37



Ivory White 62



Buff 67

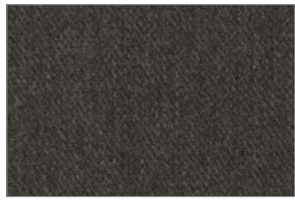

Army Brown 85



Ash 92

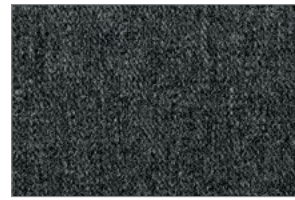

Steel 97

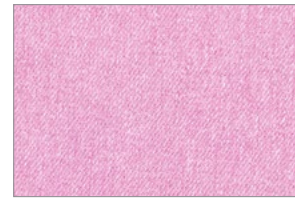

Cotton Candy 102

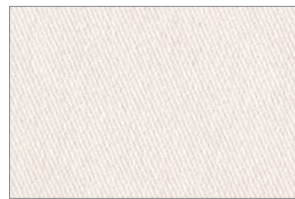

Ivory 602
Buff 6009

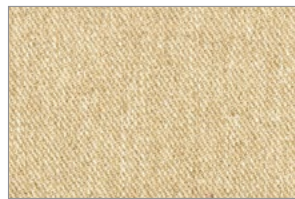

Tuscan Tan 802



Latte 806



Earth Grey 902



Charcoal 908

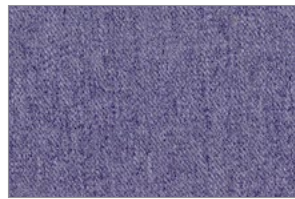

Violet 1009



Dazzling 3003



Denim 3006



Camel 81



Acid Wash 305



Rich Grey 904



Cinnamon Brown 8006

JOURNEY FABRIC SPECIFICATION:

Abrasion: Exceeds 125,000 Double Rubs.

Backing Content: 100% Acrylic

Cleaning Instruction: MWC - Machine Wash with care.

Colors Available: 20 colors available.

Content: 100% Polyester

Crocking: AATCC 8: Dry 4.5, Wet 4.5

Fire Retardancy: California (CAL) Bulletin 117-Section E, UFAC Class 1.

Pilling: ASTM D3511: Class 4.5

Seam Slippage: ASTM D4034: Warp = 135 lbs. and Fill = 130 lbs.

Tear Strength: ASTM D2261 - Warp = 20 lbs and Fill = 17 lbs..

Tensile Strength: ASTM D5034: Warp = 295 lbs and Fill = 194 lbs.

Ultraviolet: Colorfastness to Light ASTM D3597-02(2013)--Fading 5.0 - 40 hours

Weight: 9.74 ounces per square yard. 14.88 ounces per linear yard

*To request large individual Sample Colors please visit www.jennisfabrics.com

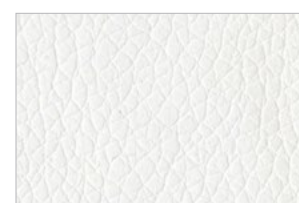

White 3822

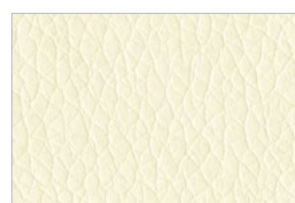

Vanilla 61

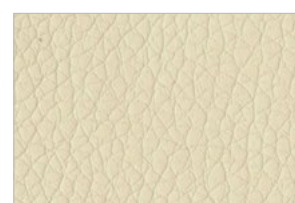

Cream 6003

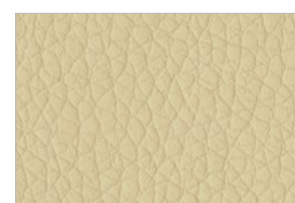

Parchment 605

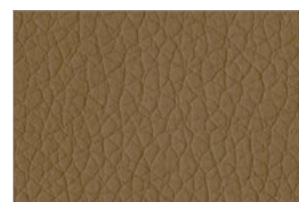

Sandstone 608

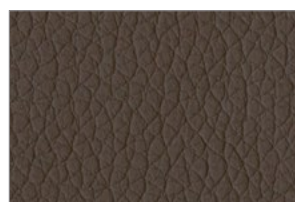

Mocha 808

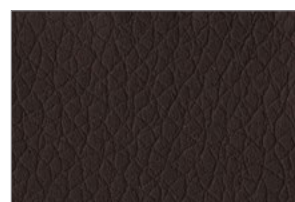

Bisque 805

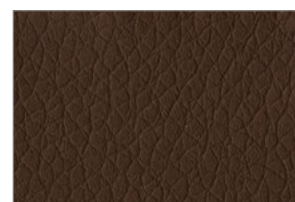

Earth 84

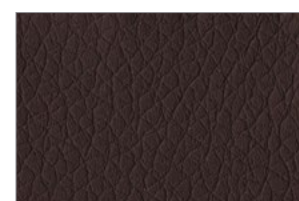

Chestnut 87

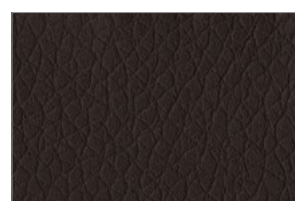

Chocolate 8020



Chinchilla 6009

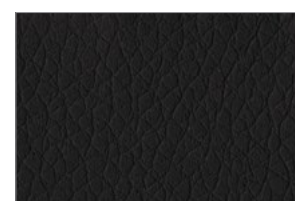

Black 9009

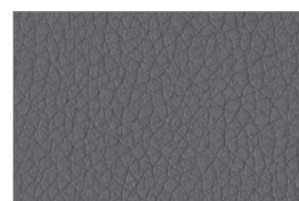

Steel 905

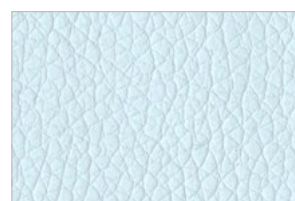

Lagoon 37

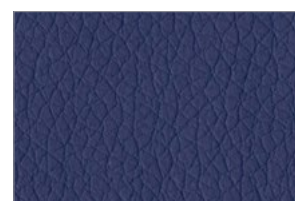

Pacific Blue 3003

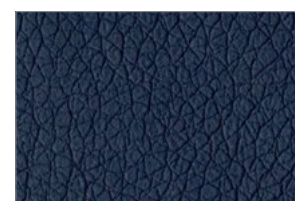

Navy 3006



Plum 1009



Citron 54

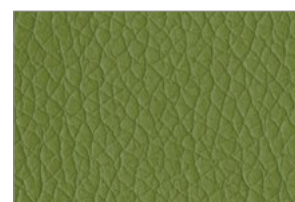

Sprig 205



Taupe 3948

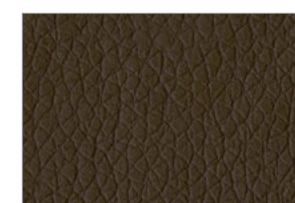

Tan 802

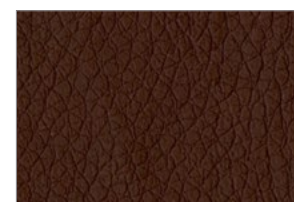

Brick 11

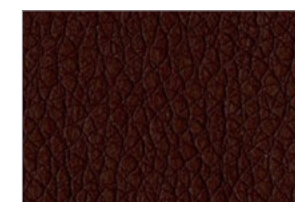

Wine 108



Grey 9003

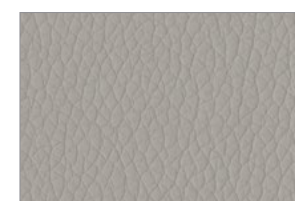

Quicksilver 95

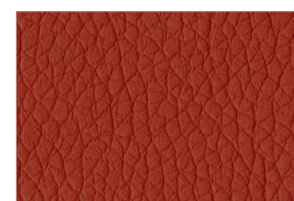

Rust 14

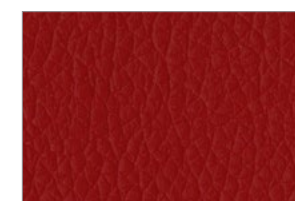

Garnet 17

TURNER VINYL SPECIFICATION:

Abrasion: Exceeds 500,000 Double Rubs.

Backing Content: 30% Cotton 70% Polyester

Cleaning Instruction: Water/Solvent Based Cleaner. Do not bleach

Cold Crack: Product Cold Crack is equal to or greater than -40 degrees Celsius (-40 Fahrenheit)

Colors Available: 26 colors available.

Construction: Vinyl

Content: 100% Polyurethane (PU)

Description: Simulated Leather Vinyl, Contract Rated

Eco Friendly: Eco-Friendly

Elongation: ASTM D5034: Warp: 23.4%, Fill: 38.1 %

Features: Phthalate Free Wipe with a soft cloth, with cold water and a mild soap. Dry immediately. PVC Free

Fire Retardancy: California Bulletin 117-Section E, Motor Vehicle Safety Standard 302. NFPA 260 Class 1. UFAC Class 1

Seam Slippage: Passes ASTM D751 - Warp = 116 lbs and Fill = 90 lbs.

Tear Strength: Passes ASTM D2261 - Warp = 20 lbs and Fill = 12 lbs.

Tensile Strength: Passes ASTM D5034 - Warp = 105 lbs and Fill = 74 lbs.

Ultraviolet: Colorfastness to Light AATCC16 Class 4.5

Weight: 14.12 ounces per square yard. 21.18 Ounces per Linear Yard

*To request large individual Sample Colors please visit www.jennisfabrics.com

1230 Reid Street
Richmond Hill
Ontario Canada
L4B 1C4

T 905 731 9300
F 905 731 9878
TF 800 413 4440

info@palmierifurniture.com
www.PalmieriFurniture.com